

| NO. OF CKTS. | DIM. A                        | DIM. B                        |
|--------------|-------------------------------|-------------------------------|
| 1            | (2.44 ± .15)<br>.096 ± .006   | —                             |
| 2            | (4.98 ± .15)<br>.196 ± .006   | (2.54 ± .10)<br>.100 ± .004   |
| 3            | (7.52 ± .15)<br>.296 ± .006   | (5.08 ± .10)<br>.200 ± .004   |
| 4            | (10.06 ± .15)<br>.396 ± .006  | (7.62 ± .10)<br>.300 ± .004   |
| 5            | (12.60 ± .18)<br>.496 ± .007  | (10.16 ± .13)<br>.400 ± .005  |
| 6            | (15.14 ± .18)<br>.596 ± .007  | (12.70 ± .13)<br>.500 ± .005  |
| 7            | (17.68 ± .20)<br>.696 ± .008  | (15.24 ± .15)<br>.600 ± .006  |
| 8            | (20.22 ± .20)<br>.796 ± .008  | (17.78 ± .15)<br>.700 ± .006  |
| 9            | (22.76 ± .20)<br>.896 ± .008  | (20.32 ± .15)<br>.800 ± .006  |
| 10           | (25.30 ± .25)<br>.996 ± .010  | (22.86 ± .20)<br>.900 ± .008  |
| 11           | (27.84 ± .25)<br>1.096 ± .010 | (25.40 ± .20)<br>1.000 ± .008 |
| 12           | (30.38 ± .25)<br>1.196 ± .010 | (27.94 ± .20)<br>1.100 ± .008 |
| 13           | (32.92 ± .25)<br>1.296 ± .010 | (30.48 ± .20)<br>1.200 ± .008 |
| 14           | (35.46 ± .25)<br>1.396 ± .010 | (33.02 ± .20)<br>1.300 ± .008 |
| 15           | (38.00 ± .28)<br>1.496 ± .011 | (35.56 ± .23)<br>1.400 ± .009 |
| 16           | (40.54 ± .28)<br>1.596 ± .011 | (38.10 ± .23)<br>1.500 ± .009 |
| 17           | (43.08 ± .28)<br>1.696 ± .011 | (40.64 ± .23)<br>1.600 ± .009 |
| 18           | (45.62 ± .28)<br>1.796 ± .011 | (43.18 ± .23)<br>1.700 ± .009 |
| 19           | (48.16 ± .28)<br>1.896 ± .011 | (45.72 ± .23)<br>1.800 ± .009 |
| 20           | (50.70 ± .30)<br>1.996 ± .012 | (48.26 ± .25)<br>1.900 ± .010 |

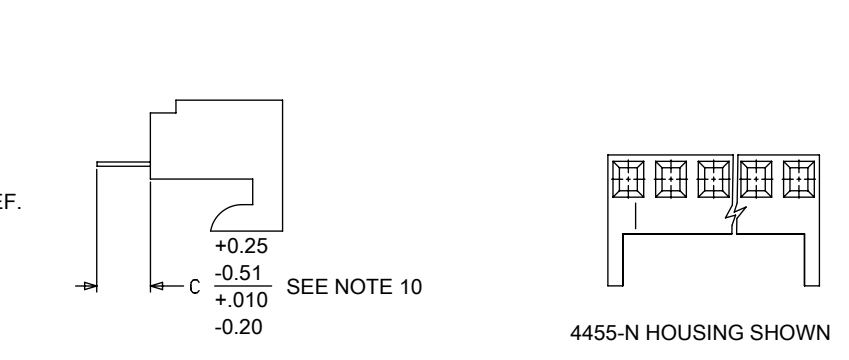

- NOTES:
- MATERIAL: NYLON, UL 94V-0, COLOR: WHITE
  - FINISH:
    - (208) - SELECT GOLD: (0.00038)/.000015 MIN., SELECT TIN: (0.00254)/.000100 MIN. OVERALL NICKEL UNDERPLATE: (0.00127)/.000050 MIN.
    - (228) - SELECT GOLD: (0.00076)/.000030 MIN., SELECT TIN: (0.00254)/.000100 MIN. OVERALL NICKEL UNDERPLATE: (0.00127)/.000050 MIN.
    - (231) - SELECT GOLD: (0.00127)/.000050 MIN., SELECT TIN: (0.00254)/.000100 MIN. OVERALL NICKEL UNDERPLATE: (0.00127)/.000050 MIN.
    - (565) - SELECT GOLD: (0.00051)/.000020 MIN., OVERALL NICKEL: (0.00076)/.000030 MIN. OVERALL GOLD FLASH: (0.00005)/.000002 MIN.
    - (P909) - OVERALL TIN: (0.00254)/.000100 MIN.
  - PARTS CONFORM TO PRODUCT SPECIFICATION PS-10-07.
  - PACKAGING: SEE CHARTS.
  - PARTS MUST CONFORM TO SOLDERABILITY SPEC 152.
  - PARTS ARE STACKABLE END TO END ON (2.54)/.100 CENTERS.
  - TYPICAL PCB THICKNESS: (1.57)/.062
  - PART CONFORMS TO CLASS B REQUIREMENTS OF COSMETIC SPECIFICATION PS-45499-002 EXCEPT PROTRUSIONS. PARTS MAY HAVE MORE THAN 2 GATE MARKS.
  - WHEN MATING ASSEMBLIES THAT USE 4455-BN HOUSINGS TO BREAKAWAY FRICTION LOCK OR POLARIZING HEADERS, THE END BACKWALLS MUST BE REMOVED.
  - DIMENSION C MEASURED WITH TERMINAL PUSHED IN AGAINST THE STOP.

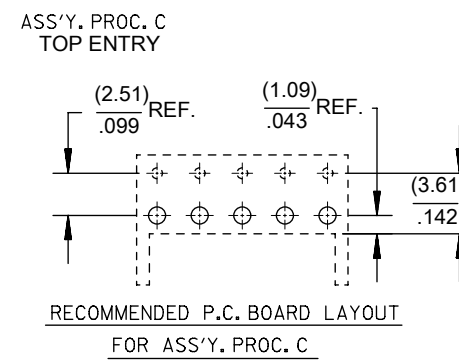
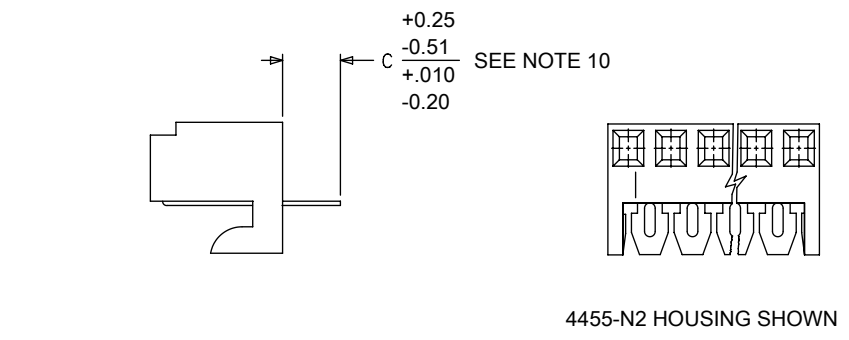
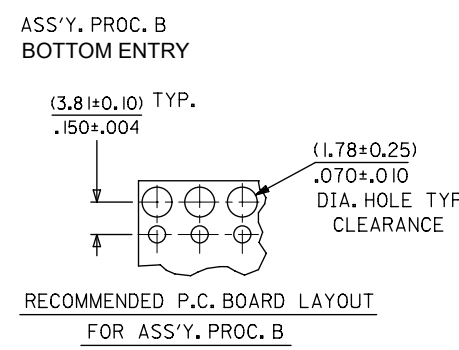
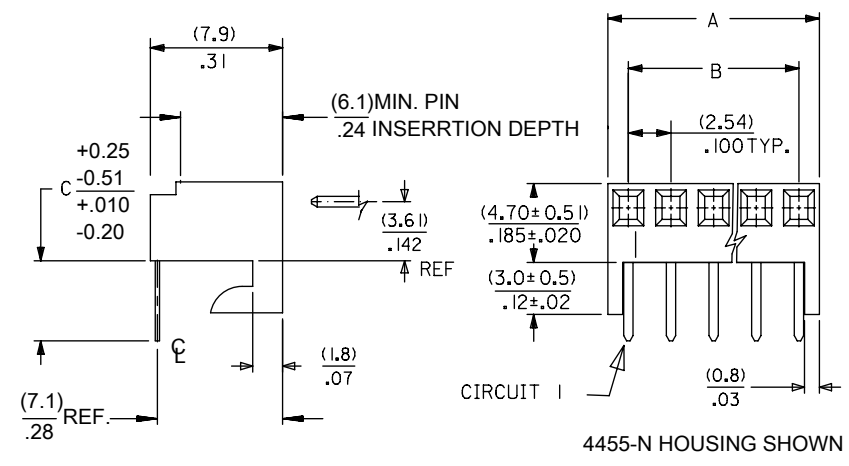
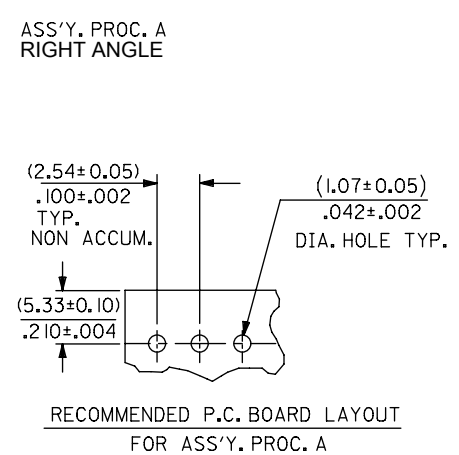
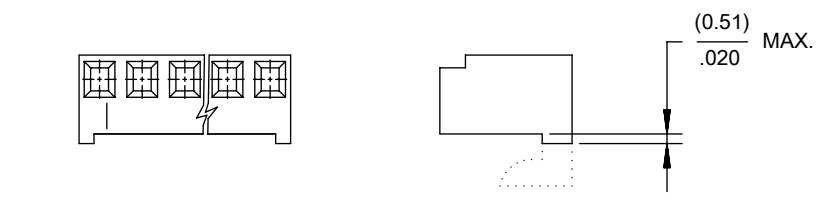
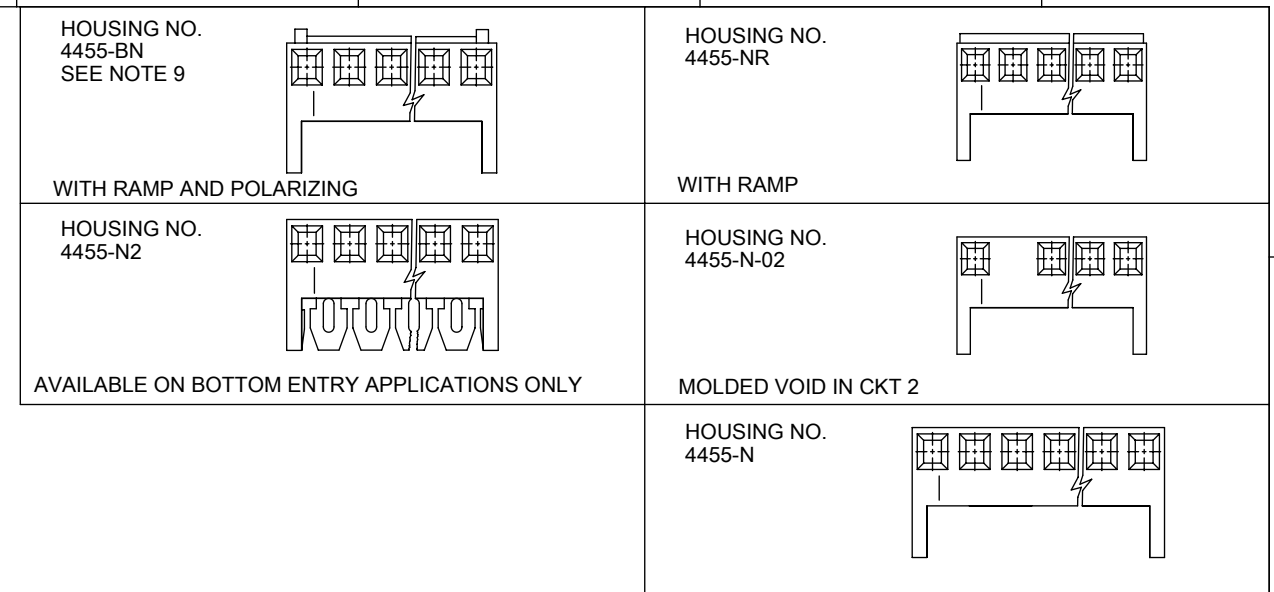

HOOKS CUT OPTION AVAILABLE ON TOP ENTRY, SEE CHART

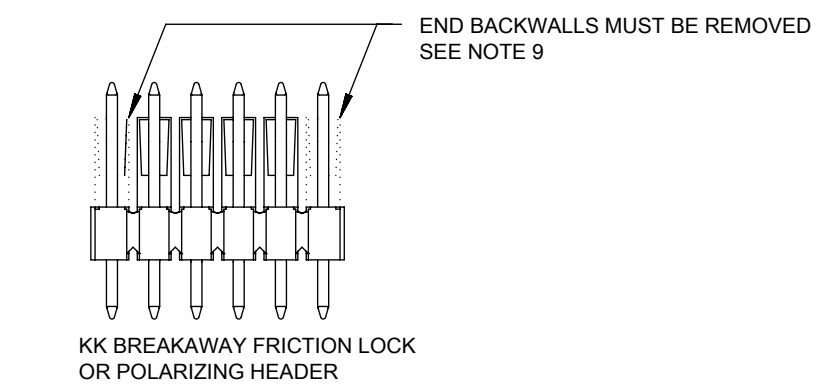

|                 |    |              |            |          |
|-----------------|----|--------------|------------|----------|
| DOCUMENT STATUS | P1 | RELEASE DATE | 2022/07/29 | 12:32:02 |
|-----------------|----|--------------|------------|----------|

THIS DRAWING CONTAINS INFORMATION THAT IS PROPRIETARY TO MOLEX ELECTRONIC TECHNOLOGIES, LLC AND SHOULD NOT BE USED WITHOUT WRITTEN PERMISSION

|  |                        |   |              |
|--|------------------------|---|--------------|
| DIMENSION UNITS                                      | SCALE                  | CURRENT REV DESC: REMOVED OBSOLETE PART NUMBER AS PER PCN#512128. |              |
| MM/IN  | 1:1                    |   |              |
| GENERAL TOLERANCES (UNLESS SPECIFIED)                |                        |   |              |
|  | MM                     | INCH  |              |
| 4 PLACES   | ±                      | ±   |              |
| 3 PLACES   | ±                      | ± 0.01  |              |
| 2 PLACES   | ± 0.25                 | ± 0.015   |              |
| 1 PLACE  | ± 0.36                 | ±   |              |
| 0 PLACES   | ±                      | ±   |              |
| ANGULAR TOL  | ± 0.5°                 |   |              |
| DRAFT WHERE APPLICABLE MUST REMAIN WITHIN DIMENSIONS | THIRD ANGLE PROJECTION | DRAWING   | SERIES       |
|  |                        | B-SIZE  | 4455         |
| MATERIAL NUMBER                                      |                        | CUSTOMER  | SHEET NUMBER |
| SEE CHART  |                        | GENERAL MARKET  | 1 OF 15      |

EC NO: 716046  
 DRWN: SANTHN 2022/07/22  
 CHKD: GGA 2022/07/29  
 APPR: GGA 2022/07/29

INITIAL REVISION:  
 DRWN: SAMIEC 1984/05/10  
 APPR: LENZ 1984/05/10

DOCUMENT NUMBER: SDA-4455  
 DOC TYPE: PSD  
 DOC PART: 001  
 REVISION: D18

**molex**

KK 100 PCB ASSY  
 4455 SERIES DWG

PRODUCT CUSTOMER DRAWING

# KK 100 PCB ASSY 2-25 CKT 4455 SERIES

A-4455- \* \* N \* \* - \*

ASSY PROCEDURE  
 A=RIGHT ANGLE  
 B=BOTTOM ENTRY  
 C=TOP ENTRY

HOUSING OPTION

- A=4455-AN
- B=4455-BN
- E=4455-NHH
- G=4455-BN (HOOKS CUT OFF)
- H=4455-N2 (BOTTOM ENTRY ONLY)
- P=4455-NR (HOOKS CUT OFF)
- R=4455-NR
- V=4455-N-02
- W=4455-N-02 (HOOKS CUT OFF)
- Y=4455-N (HOOKS CUT OFF)
- Z=4455-N

NO OF CIRCUITS

TERMINAL TYPE

| Code | Number  | Material    | Form        |
|------|---------|-------------|-------------|
| A    | 4316-4  | Brass       | Standard    |
| B    | 6516-4  | Phos Bronze | Standard    |
| C    | 6516-5C | Phos Bronze | Cat Ear / V |
| D    | 4316-3B | Brass       | Std / V     |
| F    | 6516-6C | Phos Bronze | Cat Ear / V |
| G    | 4316-3  | Brass       | Standard    |
| J    | 6516-3B | Phos Bronze | Std / V     |
| L    | 6516-3C | Phos Bronze | Cat Ear / V |
| M    | 6516-4A | Phos Bronze | Cat Ear     |
| T    | 4316-4A | Brass       | Cat Ear     |

PLATING

(SEE SHEET 1)

VOID LOCATION  
 NUMBER = CIRCUIT VOIDED  
 MULTIPLE VOIDS START  
 WITH 51  
 BLANK = NONE

| Ckts        | Assy Proc:      | RIGHT ANGLE        | Assy Proc:      | RIGHT ANGLE       |
|-------------|-----------------|--------------------|-----------------|-------------------|
|             |                 | Hooks Cut:         | NO              | Hooks Cut:        |
|             | Housing No:     | 4455-N             | Housing No:     | 4455-N            |
|             | Terminal No:    | 4316-4(P909)       | Terminal No:    | 4316-4(565)       |
|             | Dim C:          | 3.35 / .132        | Dim C:          | 3.35 / .132       |
|             | Plating:        | P909               | Plating:        | 565               |
|             | Packaging:      | PK-44646-001       | Packaging:      | PK-44646-001      |
|             | Voids:          | NONE               | Voids:          | NONE              |
|             |                 |                    |                 |                   |
| Material No | Engineer Number | Material No        | Engineer Number |                   |
| 2           | 22-15-2026      | A-4455-AZ02A(P909) | 22-16-2021      | A-4455-AZ02A(565) |
| 3           | 22-15-2036      | A-4455-AZ03A(P909) | 22-16-2031      | A-4455-AZ03A(565) |
| 4           | 22-15-2046      | A-4455-AZ04A(P909) | 22-16-2041      | A-4455-AZ04A(565) |
| 5           | 22-15-2056      | A-4455-AZ05A(P909) | 22-16-2051      | A-4455-AZ05A(565) |
| 6           | 22-15-2066      | A-4455-AZ06A(P909) | 22-16-2061      | A-4455-AZ06A(565) |
| 7           | 22-15-2076      | A-4455-AZ07A(P909) | 22-16-2071      | A-4455-AZ07A(565) |
| 8           | 22-15-2086      | A-4455-AZ08A(P909) | 22-16-2081      | A-4455-AZ08A(565) |
| 9           | 22-15-2096      | A-4455-AZ09A(P909) | 22-16-2091      | A-4455-AZ09A(565) |
| 10          | 22-15-2106      | A-4455-AZ10A(P909) | 22-16-2101      | A-4455-AZ10A(565) |
| 11          | 22-15-2116      | A-4455-AZ11A(P909) | 22-16-2111      | A-4455-AZ11A(565) |
| 12          | 22-15-2126      | A-4455-AZ12A(P909) | 22-16-2121      | A-4455-AZ12A(565) |
| 13          | 22-15-2136      | A-4455-AZ13A(P909) | 22-16-2131      | A-4455-AZ13A(565) |
| 14          | 22-15-2146      | A-4455-AZ14A(P909) | 22-16-2141      | A-4455-AZ14A(565) |
| 15          | 22-15-2156      | A-4455-AZ15A(P909) | 22-16-2151      | A-4455-AZ15A(565) |
| 16          | 22-15-2166      | A-4455-AZ16A(P909) | 22-16-2161      | A-4455-AZ16A(565) |
| 17          | 22-15-2176      | A-4455-AZ17A(P909) | 22-16-2171      | A-4455-AZ17A(565) |
| 18          | 22-15-2186      | A-4455-AZ18A(P909) | 22-16-2181      | A-4455-AZ18A(565) |
| 19          | 22-15-2196      | A-4455-AZ19A(P909) | 22-16-2191      | A-4455-AZ19A(565) |
| 20          | 22-15-2206      | A-4455-AZ20A(P909) | 22-16-2201      | A-4455-AZ20A(565) |
| 21          |                 |                    |                 |                   |
| 22          |                 |                    |                 |                   |
| 23          |                 |                    |                 |                   |
| 24          |                 |                    |                 |                   |
| 25          |                 |                    |                 |                   |

|   |  |                     |  |   |  |   |  |                 |  |                            |  |
|---|--|---------------------|--|---|--|---|--|-----------------|--|----------------------------|--|
| THIS DRAWING CONTAINS INFORMATION THAT IS PROPRIETARY TO MOLEX ELECTRONIC TECHNOLOGIES, LLC AND SHOULD NOT BE USED WITHOUT WRITTEN PERMISSION |  |                     |  |   |  |   |  |                 |  |                            |  |
| DIMENSION UNITS<br><b>MM/IN</b>   |  | SCALE<br><b>1:1</b> |  | CURRENT REV DESC: REMOVED OBSOLETE PART NUMBER AS PER PCN#512128. |  |   |  | molex           |  |                            |  |
| GENERAL TOLERANCES (UNLESS SPECIFIED)   |  |                     |  |   |  | EC NO: 716046<br>DRWN: SANTHN<br>CHKD: GGA<br>APPR: GGA<br>2022/07/22<br>2022/07/29<br>2022/07/29 |  |                 |  |                            |  |
|   |  | MM                  |  | INCH  |  |   |  |                 |  |                            |  |
| 4 PLACES ±  |  | ±                   |  | ±   |  | INITIAL REVISION:   |  | DOCUMENT NUMBER |  | DOC TYPE DOC PART REVISION |  |
| 3 PLACES ±  |  | ± 0.01              |  | ±   |  | DRWN: SAMIEC  |  | SDA-4455        |  | PSD 001 D18                |  |
| 2 PLACES ±  |  | ± 0.25              |  | ± 0.015   |  | APPR: LENZ  |  | 1984/05/10      |  | 1984/05/10                 |  |
| 1 PLACE ±   |  | ± 0.36              |  | ±   |  | THIRD ANGLE PROJECTION  |  | DRAWING         |  | SERIES                     |  |
| 0 PLACES ±  |  | ±                   |  | ±   |  | DRAFT WHERE APPLICABLE MUST REMAIN WITHIN DIMENSIONS  |  | B-SIZE          |  | 4455                       |  |
| ANGULAR TOL ±   |  | ± 0.5°              |  | ±   |  | MATERIAL NUMBER   |  | CUSTOMER        |  | SHEET NUMBER               |  |
|   |  |                     |  |   |  | SEE CHART   |  | GENERAL MARKET  |  | 2 OF 15                    |  |

# KK 100 PCB ASSY 2-25 CKT 4455 SERIES

STANDARD PRODUCT

| Ckts | Assy Proc: RIGHT ANGLE |                     | Assy Proc: BOTTOM ENTRY |                      | Assy Proc: BOTTOM ENTRY |                     | Assy Proc: BOTTOM ENTRY |                     |
|------|------------------------|---------------------|-------------------------|----------------------|-------------------------|---------------------|-------------------------|---------------------|
|      | Material No            | Engineer Number     | Material No             | Engineer Number      | Material No             | Engineer Number     | Material No             | Engineer Number     |
| 2    | 22-16-2020             | A-4455-AZ02A(208)   | 22-14-2024              | A-4455-BH02D(P909)   | 22-17-2022              | A-4455-BH02D(565)   | 22-17-3022              | A-4455-BH02D(208)   |
| 3    | 22-16-2030             | A-4455-AZ 03 A(208) | 22-14-2034              | A-4455-BH 03 D(P909) | 22-17-2032              | A-4455-BH 03 D(565) | 22-17-3032              | A-4455-BH 03 D(208) |
| 4    | 22-16-2040             | A-4455-AZ 04 A(208) | 22-14-2044              | A-4455-BH 04 D(P909) | 22-17-2042              | A-4455-BH 04 D(565) | 22-17-3042              | A-4455-BH 04 D(208) |
| 5    | 22-16-2050             | A-4455-AZ 05 A(208) | 22-14-2054              | A-4455-BH 05 D(P909) | 22-17-2052              | A-4455-BH 05 D(565) | 22-17-3052              | A-4455-BH 05 D(208) |
| 6    | 22-16-2060             | A-4455-AZ 06 A(208) | 22-14-2064              | A-4455-BH 06 D(P909) | 22-17-2062              | A-4455-BH 06 D(565) | 22-17-3062              | A-4455-BH 06 D(208) |
| 7    | 22-16-2070             | A-4455-AZ 07 A(208) | 22-14-2074              | A-4455-BH 07 D(P909) | 22-17-2072              | A-4455-BH 07 D(565) | 22-17-3072              | A-4455-BH 07 D(208) |
| 8    | 22-16-2080             | A-4455-AZ 08 A(208) | 22-14-2084              | A-4455-BH 08 D(P909) | 22-17-2082              | A-4455-BH 08 D(565) | 22-17-3082              | A-4455-BH 08 D(208) |
| 9    | 22-16-2090             | A-4455-AZ 09 A(208) | 22-14-2094              | A-4455-BH 09 D(P909) | 22-17-2092              | A-4455-BH 09 D(565) | 22-17-3092              | A-4455-BH 09 D(208) |
| 10   | 22-16-2100             | A-4455-AZ 10 A(208) | 22-14-2104              | A-4455-BH 10 D(P909) | 22-17-2102              | A-4455-BH 10 D(565) | 22-17-3102              | A-4455-BH 10 D(208) |
| 11   | 22-16-2110             | A-4455-AZ 11 A(208) | 22-14-2114              | A-4455-BH 11 D(P909) | 22-17-2112              | A-4455-BH 11 D(565) | 22-17-3112              | A-4455-BH 11 D(208) |
| 12   | 22-16-2120             | A-4455-AZ 12 A(208) | 22-14-2124              | A-4455-BH 12 D(P909) | 22-17-2122              | A-4455-BH 12 D(565) | 22-17-3122              | A-4455-BH 12 D(208) |
| 13   | 22-16-2130             | A-4455-AZ 13 A(208) | 22-14-2134              | A-4455-BH 13 D(P909) | 22-17-2132              | A-4455-BH 13 D(565) | 22-17-3132              | A-4455-BH 13 D(208) |
| 14   | 22-16-2140             | A-4455-AZ 14 A(208) | 22-14-2144              | A-4455-BH 14 D(P909) | 22-17-2142              | A-4455-BH 14 D(565) | 22-17-3142              | A-4455-BH 14 D(208) |
| 15   | 22-16-2150             | A-4455-AZ 15 A(208) | 22-14-2154              | A-4455-BH 15 D(P909) | 22-17-2152              | A-4455-BH 15 D(565) | 22-17-3152              | A-4455-BH 15 D(208) |
| 16   | 22-16-2160             | A-4455-AZ 16 A(208) | 22-14-2164              | A-4455-BH 16 D(P909) | 22-17-2162              | A-4455-BH 16 D(565) | 22-17-3162              | A-4455-BH 16 D(208) |
| 17   | 22-16-2170             | A-4455-AZ 17 A(208) | 22-14-2174              | A-4455-BH 17 D(P909) | 22-17-2172              | A-4455-BH 17 D(565) | 22-17-3172              | A-4455-BH 17 D(208) |
| 18   | 22-16-2180             | A-4455-AZ 18 A(208) | 22-14-2184              | A-4455-BH 18 D(P909) |                         |                     | 22-17-3182              | A-4455-BH 18 D(208) |
| 19   | 22-16-2190             | A-4455-AZ 19 A(208) | 22-14-2194              | A-4455-BH 19 D(P909) |                         |                     | 22-17-3192              | A-4455-BH 19 D(208) |
| 20   | 22-16-2200             | A-4455-AZ 20 A(208) | 22-14-2204              | A-4455-BH 20 D(P909) | 22-17-2202              | A-4455-BH 20 D(565) | 22-17-3202              | A-4455-BH 20 D(208) |
| 21   |                        |                     |                         |                      |                         |                     |                         |                     |
| 22   |                        |                     |                         |                      |                         |                     |                         |                     |
| 23   | 22-16-2230             | A-4455-AZ 23 A(208) |                         |                      |                         |                     |                         |                     |
| 24   |                        |                     |                         |                      |                         |                     |                         |                     |
| 25   |                        |                     |                         |                      |                         |                     |                         |                     |

|   |  |                     |  |   |  |                   |  |   |  |  |  |
|---|--|---------------------|--|---|--|-------------------|--|---|--|--|--|
| THIS DRAWING CONTAINS INFORMATION THAT IS PROPRIETARY TO MOLEX ELECTRONIC TECHNOLOGIES, LLC AND SHOULD NOT BE USED WITHOUT WRITTEN PERMISSION |  |                     |  |   |  |                   |  |   |  |  |  |
| DIMENSION UNITS<br><b>MM/IN</b>   |  | SCALE<br><b>1:1</b> |  | CURRENT REV DESC: REMOVED OBSOLETE PART NUMBER AS PER PCN#512128. |  |                   |  | molex   |  |  |  |
| GENERAL TOLERANCES (UNLESS SPECIFIED)   |  |                     |  |   |  | EC NO: 716046     |  | KK 100 PCB ASSY<br>4455 SERIES DWG                  |  |  |  |
| 4 PLACES ±     ±  |  |                     |  |   |  | DRWN: SANTHN      |  |   |  |  |  |
| 3 PLACES ±     ± 0.01   |  |                     |  |   |  | 2022/07/22        |  | PRODUCT CUSTOMER DRAWING                            |  |  |  |
| 2 PLACES ± 0.25 ± 0.015   |  |                     |  |   |  | CHKD: GGA         |  |   |  |  |  |
| 1 PLACE ± 0.36 ±  |  |                     |  |   |  | 2022/07/29        |  | DOCUMENT NUMBER    DOC TYPE    DOC PART    REVISION |  |  |  |
| 0 PLACES ±     ±  |  |                     |  |   |  | APPR: GGA         |  |   |  |  |  |
| ANGULAR TOL ± 0.5°  |  |                     |  |   |  | INITIAL REVISION: |  | <b>SDA-4455</b> PSD    001    D18                   |  |  |  |
| DRAFT WHERE APPLICABLE MUST REMAIN WITHIN DIMENSIONS  |  |                     |  |   |  | DRWN: SAMIEC      |  |   |  |  |  |
| THIRD ANGLE PROJECTION  |  |                     |  |   |  | 1984/05/10        |  | MATERIAL NUMBER    CUSTOMER    SHEET NUMBER         |  |  |  |
| DRAWING    SERIES   |  |                     |  |   |  | 1984/05/10        |  |   |  |  |  |
| B-SIZE  |  |                     |  |   |  | 4455              |  | SEE CHART    GENERAL MARKET    3 OF 15              |  |  |  |

# KK 100 PCB ASSY 2-25 CKT 4455 SERIES

| Ckts | Assy Proc: TOP ENTRY |                      | Assy Proc: TOP ENTRY |                     | Assy Proc: TOP ENTRY |                     | Assy Proc: RIGHT ANGLE |                     |
|------|----------------------|----------------------|----------------------|---------------------|----------------------|---------------------|------------------------|---------------------|
|      | Material No          | Engineer Number      | Material No          | Engineer Number     | Material No          | Engineer Number     | Material No            | Engineer Number     |
| 2    | 22-02-2025           | A-4455-CZ02A(P909)   | 22-18-2023           | A-4455-CZ02A(565)   | 22-18-2021           | A-4455-CZ02A(208)   | 22-15-4025             | A-4455-AZ02B(P909)  |
| 3    | 22-02-2035           | A-4455-CZ 03A(P909)  | 22-18-2033           | A-4455-CZ 03 A(565) | 22-18-2031           | A-4455-CZ 03 A(208) | 22-15-4035             | A-4455-AZ 03B(P909) |
| 4    | 22-02-2045           | A-4455-CZ 04A(P909)  | 22-18-2043           | A-4455-CZ 04 A(565) | 22-18-2041           | A-4455-CZ 04 A(208) | 22-15-4045             | A-4455-AZ 04B(P909) |
| 5    | 22-02-2055           | A-4455-CZ 05A(P909)  | 22-18-2053           | A-4455-CZ 05 A(565) | 22-18-2051           | A-4455-CZ 05 A(208) | 22-15-4055             | A-4455-AZ 05B(P909) |
| 6    | 22-02-2065           | A-4455-CZ 06A(P909)  | 22-18-2063           | A-4455-CZ 06 A(565) | 22-18-2061           | A-4455-CZ 06 A(208) | 22-15-4065             | A-4455-AZ 06B(P909) |
| 7    | 22-02-2075           | A-4455-CZ 07A(P909)  | 22-18-2073           | A-4455-CZ 07 A(565) | 22-18-2071           | A-4455-CZ 07 A(208) | 22-15-4075             | A-4455-AZ 07B(P909) |
| 8    | 22-02-2085           | A-4455-CZ 08 A(P909) | 22-18-2083           | A-4455-CZ 08 A(565) | 22-18-2081           | A-4455-CZ 08 A(208) | 22-15-4085             | A-4455-AZ 08B(P909) |
| 9    | 22-02-2095           | A-4455-CZ 09 A(P909) | 22-18-2093           | A-4455-CZ 09 A(565) | 22-18-2091           | A-4455-CZ 09 A(208) | 22-15-4095             | A-4455-AZ 09B(P909) |
| 10   | 22-02-2105           | A-4455-CZ 10 A(P909) | 22-18-2103           | A-4455-CZ 10 A(565) | 22-18-2101           | A-4455-CZ 10 A(208) | 22-15-4105             | A-4455-AZ 10B(P909) |
| 11   | 22-02-2115           | A-4455-CZ 11 A(P909) | 22-18-2113           | A-4455-CZ 11 A(565) | 22-18-2111           | A-4455-CZ 11 A(208) | 22-15-4115             | A-4455-AZ 11B(P909) |
| 12   | 22-02-2125           | A-4455-CZ 12 A(P909) | 22-18-2123           | A-4455-CZ 12 A(565) | 22-18-2121           | A-4455-CZ 12 A(208) | 22-15-4125             | A-4455-AZ 12B(P909) |
| 13   | 22-02-2135           | A-4455-CZ 13 A(P909) | 22-18-2133           | A-4455-CZ 13 A(565) | 22-18-2131           | A-4455-CZ 13 A(208) | 22-15-4135             | A-4455-AZ 13B(P909) |
| 14   | 22-02-2145           | A-4455-CZ 14 A(P909) | 22-18-2143           | A-4455-CZ 14 A(565) | 22-18-2141           | A-4455-CZ 14 A(208) | 22-15-4145             | A-4455-AZ 14B(P909) |
| 15   | 22-02-2155           | A-4455-CZ 15 A(P909) |                      |                     | 22-18-2151           | A-4455-CZ 15 A(208) | 22-15-4155             | A-4455-AZ 15B(P909) |
| 16   | 22-02-2165           | A-4455-CZ 16 A(P909) |                      |                     | 22-18-2161           | A-4455-CZ 16 A(208) | 22-15-4165             | A-4455-AZ 16B(P909) |
| 17   | 22-02-2175           | A-4455-CZ 17 A(P909) |                      |                     | 22-18-2171           | A-4455-CZ 17 A(208) | 22-15-4175             | A-4455-AZ 17B(P909) |
| 18   | 22-02-2185           | A-4455-CZ 18 A(P909) | 22-18-2183           | A-4455-CZ 18 A(565) | 22-18-2181           | A-4455-CZ 18 A(208) | 22-15-4185             | A-4455-AZ 18B(P909) |
| 19   | 22-02-2195           | A-4455-CZ 19 A(P909) |                      |                     | 22-18-2191           | A-4455-CZ 19 A(208) | 22-15-4195             | A-4455-AZ 19B(P909) |
| 20   | 22-02-2205           | A-4455-CZ 20 A(P909) | 22-18-2203           | A-4455-CZ 20 A(565) | 22-18-2201           | A-4455-CZ 20 A(208) | 22-15-4205             | A-4455-AZ 20B(P909) |
| 21   |                      |                      |                      |                     |                      |                     | 22-15-4215             | A-4455-AZ 21B(P909) |
| 22   |                      |                      |                      |                     |                      |                     | 22-15-4225             | A-4455-AZ 22B(P909) |
| 23   |                      |                      |                      |                     |                      |                     | 22-15-4235             | A-4455-AZ 23B(P909) |
| 24   |                      |                      |                      |                     |                      |                     | 22-15-4245             | A-4455-AZ 24B(P909) |
| 25   |                      |                      |                      |                     |                      |                     | 22-15-4255             | A-4455-AZ 25B(P909) |

|   |                     |   |               |             |  |                |   |          |                          |
|---|---------------------|---|---------------|-------------|--|----------------|---|----------|--------------------------|
| THIS DRAWING CONTAINS INFORMATION THAT IS PROPRIETARY TO MOLEX ELECTRONIC TECHNOLOGIES, LLC AND SHOULD NOT BE USED WITHOUT WRITTEN PERMISSION |                     |   |               |             |  |                |   |          |                          |
| DIMENSION UNITS<br><b>MM/IN</b>   | SCALE<br><b>1:1</b> | CURRENT REV DESC: REMOVED OBSOLETE PART NUMBER AS PER PCN#512128. |               |             | molex                                  |                | KK 100 PCB ASSY<br>4455 SERIES DWG              |          |                          |
| GENERAL TOLERANCES (UNLESS SPECIFIED)   |                     | EC NO: 716046<br>DRWN: SANTHN<br>CHKD: GGA<br>APPR: GGA           |               |             | 2022/07/22<br>2022/07/29<br>2022/07/29 |                | PRODUCT CUSTOMER DRAWING                        |          |                          |
| 4 PLACES ±  | 3 PLACES ±          | 2 PLACES ±  | 1 PLACE ±     | 0 PLACES ±  | ANGULAR TOL ± 0.5°                     |                | INITIAL REVISION:<br>DRWN: SAMIEC<br>APPR: LENZ |          | 1984/05/10<br>1984/05/10 |
| DRAFT WHERE APPLICABLE MUST REMAIN WITHIN DIMENSIONS  |                     | THIRD ANGLE PROJECTION  | DRAWING       | SERIES      | MATERIAL NUMBER                        | CUSTOMER       | DOCUMENT NUMBER                                 | DOC TYPE | DOC PART                 |
|   |                     |   | <b>B-SIZE</b> | <b>4455</b> | SEE CHART                              | GENERAL MARKET | <b>SDA-4455</b>                                 | PSD      | 001                      |
|   |                     |   |               | 4 OF 15     | <b>D18</b>                             |                |   |          |                          |

# KK 100 PCB ASSY 2-25 CKT 4455 SERIES

| Ckts | Assy Proc: RIGHT ANGLE |                     | Assy Proc: RIGHT ANGLE |                 | Assy Proc: BOTTOM ENTRY |                     | Assy Proc: BOTTOM ENTRY |                 |
|------|------------------------|---------------------|------------------------|-----------------|-------------------------|---------------------|-------------------------|-----------------|
|      | Material No            | Engineer Number     | Material No            | Engineer Number | Material No             | Engineer Number     | Material No             | Engineer Number |
| 2    | 22-16-2024             | A-4455-AZ02B(565)   |                        |                 | 22-17-2021              | A-4455-BH02J(565)   |                         |                 |
| 3    | 22-16-2034             | A-4455-AZ 03 B(565) |                        |                 | 22-17-2031              | A-4455-BH 03 J(565) |                         |                 |
| 4    | 22-16-2044             | A-4455-AZ 04 B(565) |                        |                 | 22-17-2041              | A-4455-BH 04 J(565) |                         |                 |
| 5    | 22-16-2054             | A-4455-AZ 05 B(565) |                        |                 | 22-17-2051              | A-4455-BH 05 J(565) |                         |                 |
| 6    | 22-16-2064             | A-4455-AZ 06 B(565) |                        |                 | 22-17-2061              | A-4455-BH 06 J(565) |                         |                 |
| 7    | 22-16-2074             | A-4455-AZ 07 B(565) |                        |                 | 22-17-2071              | A-4455-BH 07 J(565) |                         |                 |
| 8    | 22-16-2084             | A-4455-AZ 08 B(565) |                        |                 | 22-17-2081              | A-4455-BH 08 J(565) |                         |                 |
| 9    | 22-16-2094             | A-4455-AZ 09 B(565) |                        |                 | 22-17-2091              | A-4455-BH 09 J(565) |                         |                 |
| 10   | 22-16-2104             | A-4455-AZ 10 B(565) |                        |                 | 22-17-2101              | A-4455-BH 10 J(565) |                         |                 |
| 11   | 22-16-2114             | A-4455-AZ 11 B(565) |                        |                 | 22-17-2111              | A-4455-BH 11 J(565) |                         |                 |
| 12   | 22-16-2124             | A-4455-AZ 12 B(565) |                        |                 | 22-17-2121              | A-4455-BH 12 J(565) |                         |                 |
| 13   | 22-16-2134             | A-4455-AZ 13 B(565) |                        |                 | 22-17-2131              | A-4455-BH 13 J(565) |                         |                 |
| 14   | 22-16-2144             | A-4455-AZ 14 B(565) |                        |                 | 22-17-2141              | A-4455-BH 14 J(565) |                         |                 |
| 15   | 22-16-2154             | A-4455-AZ 15 B(565) |                        |                 | 22-17-2151              | A-4455-BH 15 J(565) |                         |                 |
| 16   | 22-16-2164             | A-4455-AZ 16 B(565) |                        |                 | 22-17-2161              | A-4455-BH 16 J(565) |                         |                 |
| 17   | 22-16-2174             | A-4455-AZ 17 B(565) |                        |                 | 22-17-2171              | A-4455-BH 17 J(565) |                         |                 |
| 18   | 22-16-2184             | A-4455-AZ 18 B(565) |                        |                 | 22-17-2181              | A-4455-BH 18 J(565) |                         |                 |
| 19   | 22-16-2194             | A-4455-AZ 19 B(565) |                        |                 | 22-17-2191              | A-4455-BH 19 J(565) |                         |                 |
| 20   | 22-16-2204             | A-4455-AZ 20 B(565) |                        |                 | 22-17-2201              | A-4455-BH 20 J(565) |                         |                 |
| 21   | 22-16-2214             | A-4455-AZ 21 B(565) |                        |                 | 22-17-2211              | A-4455-BH 21 J(565) |                         |                 |
| 22   | 22-16-2224             | A-4455-AZ 22 B(565) |                        |                 | 22-17-2221              | A-4455-BH 22 J(565) |                         |                 |
| 23   | 22-16-2234             | A-4455-AZ 23 B(565) |                        |                 | 22-17-2231              | A-4455-BH 23 J(565) |                         |                 |
| 24   | 22-16-2244             | A-4455-AZ 24 B(565) |                        |                 | 22-17-2241              | A-4455-BH 24 J(565) |                         |                 |
| 25   |                        |                     |                        |                 | 22-17-2251              | A-4455-BH 25 J(565) |                         |                 |

|   |  |                     |  |   |  |                            |  |                                       |  |                        |  |
|---|--|---------------------|--|---|--|----------------------------|--|---------------------------------------|--|------------------------|--|
| THIS DRAWING CONTAINS INFORMATION THAT IS PROPRIETARY TO MOLEX ELECTRONIC TECHNOLOGIES, LLC AND SHOULD NOT BE USED WITHOUT WRITTEN PERMISSION |  |                     |  |   |  |                            |  |                                       |  |                        |  |
| DIMENSION UNITS<br><b>MM/IN</b>   |  | SCALE<br><b>1:1</b> |  | CURRENT REV DESC: REMOVED OBSOLETE PART NUMBER AS PER PCN#512128. |  |                            |  | molex                                 |  |                        |  |
| GENERAL TOLERANCES (UNLESS SPECIFIED)   |  |                     |  |   |  | EC NO: 716046              |  | KK 100 PCB ASSY<br>4455 SERIES DWG    |  |                        |  |
|   |  | MM                  |  | INCH  |  | DRWN: SANTHN<br>2022/07/22 |  |                                       |  |                        |  |
| 4 PLACES ±  |  |                     |  |   |  | CHKD: GGA<br>2022/07/29    |  | PRODUCT CUSTOMER DRAWING              |  |                        |  |
| 3 PLACES ±  |  |                     |  |   |  | APPR: GGA<br>2022/07/29    |  | DOCUMENT NUMBER                       |  |                        |  |
| 2 PLACES ±  |  | 0.25                |  | ± 0.015   |  | INITIAL REVISION:          |  | DOC TYPE DOC PART REVISION            |  |                        |  |
| 1 PLACE ±   |  | 0.36                |  | ±   |  | DRWN: SAMIEC<br>1984/05/10 |  | SDA-4455                              |  | PSD 001 D18            |  |
| 0 PLACES ±  |  |                     |  |   |  | APPR: LENZ<br>1984/05/10   |  | MATERIAL NUMBER CUSTOMER SHEET NUMBER |  |                        |  |
| ANGULAR TOL ±   |  | 0.5°                |  | ±   |  | THIRD ANGLE PROJECTION     |  | DRAWING                               |  | SERIES                 |  |
| DRAFT WHERE APPLICABLE<br>MUST REMAIN<br>WITHIN DIMENSIONS  |  |                     |  | B-SIZE  |  | 4455                       |  | SEE CHART                             |  | GENERAL MARKET 5 OF 15 |  |

# KK 100 PCB ASSY 2-25 CKT 4455 SERIES

| Ckts | Assy Proc: TOP ENTRY |                 | Assy Proc: TOP ENTRY |                     | Assy Proc: TOP ENTRY |                 | Assy Proc: RIGHT ANGLE |                     |
|------|----------------------|-----------------|----------------------|---------------------|----------------------|-----------------|------------------------|---------------------|
|      | Material No          | Engineer Number | Material No          | Engineer Number     | Material No          | Engineer Number | Material No            | Engineer Number     |
| 2    |                      |                 | 22-18-2022           | A-4455-CZ02B(565)   |                      |                 |                        |                     |
| 3    |                      |                 | 22-18-2032           | A-4455-CZ 03 B(565) |                      |                 |                        |                     |
| 4    |                      |                 | 22-18-2042           | A-4455-CZ 04 B(565) |                      |                 |                        |                     |
| 5    |                      |                 | 22-18-2052           | A-4455-CZ 05 B(565) |                      |                 |                        |                     |
| 6    |                      |                 | 22-18-2062           | A-4455-CZ 06 B(565) |                      |                 |                        |                     |
| 7    |                      |                 | 22-18-2072           | A-4455-CZ 07 B(565) |                      |                 | 22-15-2075             | A-4455-AA07A(P909)  |
| 8    |                      |                 | 22-18-2082           | A-4455-CZ 08 B(565) |                      |                 | 22-15-2085             | A-4455-AA 08A(P909) |
| 9    |                      |                 | 22-18-2092           | A-4455-CZ 09 B(565) |                      |                 | 22-15-2095             | A-4455-AA 09A(P909) |
| 10   |                      |                 | 22-18-2102           | A-4455-CZ 10 B(565) |                      |                 | 22-15-2105             | A-4455-AA 10A(P909) |
| 11   |                      |                 | 22-18-2112           | A-4455-CZ 11 B(565) |                      |                 | 22-15-2115             | A-4455-AA 11A(P909) |
| 12   |                      |                 | 22-18-2122           | A-4455-CZ 12 B(565) |                      |                 |                        |                     |
| 13   |                      |                 | 22-18-2132           | A-4455-CZ 13 B(565) |                      |                 | 22-15-2135             | A-4455-AA 13A(P909) |
| 14   |                      |                 | 22-18-2142           | A-4455-CZ 14 B(565) |                      |                 | 22-15-2145             | A-4455-AA 14A(P909) |
| 15   |                      |                 | 22-18-2152           | A-4455-CZ 15 B(565) |                      |                 | 22-15-2155             | A-4455-AA 15A(P909) |
| 16   |                      |                 | 22-18-2162           | A-4455-CZ 16 B(565) |                      |                 | 22-15-2165             | A-4455-AA 16A(P909) |
| 17   |                      |                 | 22-18-2172           | A-4455-CZ 17 B(565) |                      |                 | 22-15-2175             | A-4455-AA 17A(P909) |
| 18   |                      |                 | 22-18-2182           | A-4455-CZ 18 B(565) |                      |                 |                        |                     |
| 19   |                      |                 | 22-18-2192           | A-4455-CZ 19 B(565) |                      |                 | 22-15-2195             | A-4455-AA 19A(P909) |
| 20   |                      |                 | 22-18-2202           | A-4455-CZ 20 B(565) |                      |                 |                        |                     |
| 21   |                      |                 | 22-18-2212           | A-4455-CZ 21 B(565) |                      |                 | 22-15-2215             | A-4455-AA 21A(P909) |
| 22   |                      |                 | 22-18-2222           | A-4455-CZ 22 B(565) |                      |                 | 22-15-2225             | A-4455-AA 22A(P909) |
| 23   |                      |                 | 22-18-2232           | A-4455-CZ 23 B(565) |                      |                 |                        |                     |
| 24   |                      |                 | 22-18-2242           | A-4455-CZ 24 B(565) |                      |                 | 22-15-2245             | A-4455-AA 24A(P909) |
| 25   |                      |                 | 22-18-2252           | A-4455-CZ 25 B(565) |                      |                 | 22-15-2255             | A-4455-AA 25A(P909) |

|   |  |                        |  |   |  |                   |  |                                    |  |                      |  |            |  |
|---|--|------------------------|--|---|--|-------------------|--|------------------------------------|--|----------------------|--|------------|--|
| THIS DRAWING CONTAINS INFORMATION THAT IS PROPRIETARY TO MOLEX ELECTRONIC TECHNOLOGIES, LLC AND SHOULD NOT BE USED WITHOUT WRITTEN PERMISSION |  |                        |  |   |  |                   |  |                                    |  |                      |  |            |  |
| DIMENSION UNITS<br><b>MM/IN</b>   |  | SCALE<br><b>1:1</b>    |  | CURRENT REV DESC: REMOVED OBSOLETE PART NUMBER AS PER PCN#512128. |  |                   |  | molex                              |  |                      |  |            |  |
| GENERAL TOLERANCES (UNLESS SPECIFIED)   |  |                        |  |   |  | EC NO: 716046     |  | KK 100 PCB ASSY<br>4455 SERIES DWG |  |                      |  |            |  |
| 4 PLACES ±  |  | MM                     |  | INCH  |  | DRWN: SANTHN      |  |                                    |  |                      |  | 2022/07/22 |  |
| 3 PLACES ±  |  | 0.25                   |  | 0.015   |  | CHKD: GGA         |  |                                    |  |                      |  | 2022/07/29 |  |
| 2 PLACES ±  |  | 0.36                   |  | ±   |  | APPR: GGA         |  |                                    |  |                      |  | 2022/07/29 |  |
| 1 PLACE ±   |  | 0.5°                   |  | ANGULAR TOL ±   |  | INITIAL REVISION: |  | DOCUMENT NUMBER                    |  |                      |  |            |  |
| 0 PLACES ±  |  | THIRD ANGLE PROJECTION |  | DRAWING   |  | SERIES            |  | MATERIAL NUMBER                    |  | CUSTOMER             |  |            |  |
| DRAFT WHERE APPLICABLE MUST REMAIN WITHIN DIMENSIONS  |  | B-SIZE                 |  | 4455  |  | 1984/05/10        |  | 1984/05/10                         |  | SDA-4455 PSD 001 D18 |  |            |  |
| SHEET NUMBER  |  | 6 OF 15                |  | GENERAL MARKET  |  | SEE CHART         |  |                                    |  |                      |  |            |  |

# KK 100 PCB ASSY 2-25 CKT

## 4455 SERIES

| Ckts | Assy Proc: RIGHT ANGLE |                     | Assy Proc: RIGHT ANGLE |                     | Assy Proc: RIGHT ANGLE |                     | Assy Proc: RIGHT ANGLE |                     |
|------|------------------------|---------------------|------------------------|---------------------|------------------------|---------------------|------------------------|---------------------|
|      |                        | Hooks Cut:          | NO                     | Hooks Cut:          | NO                     | Hooks Cut:          | NO                     | Hooks Cut:          |
|      | Housing No:            | 4455-AN             | Housing No:            | 4455-BN             | Housing No:            | 4455-BN             | Housing No:            | 4455-NHH            |
|      | Terminal No:           | 4316-4(208)         | Terminal No:           | 4316-4(228)         | Terminal No:           | 4316-4(P909)        | Terminal No:           | 4316-4(P909)        |
|      | Dim C:                 | 3.35 / .132         | Dim C:                 | 3.35 / .132         | Dim C:                 | 3.35 / .132         | Dim C:                 | 3.35 / .132         |
|      | Plating:               | 208                 | Plating:               | 228                 | Plating:               | P909                | Plating:               | P909                |
|      | Packaging:             | PK-44646-001        | Packaging:             | PK-44646-002        | Packaging:             | PK-44646-002        | Packaging:             | PK-44646-001        |
|      | Voids:                 | NONE                | Voids:                 | NONE                | Voids:                 | NONE                | Voids:                 | NONE                |
|      | Material No            | Engineer Number     | Material No            | Engineer Number     | Material No            | Engineer Number     | Material No            | Engineer Number     |
| 2    |                        |                     |                        |                     | 22-15-4024             | A-4455-AB02A(P909)  |                        |                     |
| 3    |                        |                     |                        |                     | 22-15-4034             | A-4455-AB 03A(P909) |                        |                     |
| 4    |                        |                     |                        |                     | 22-15-4044             | A-4455-AB 04A(P909) |                        |                     |
| 5    |                        |                     |                        |                     | 22-15-4054             | A-4455-AB 05A(P909) |                        |                     |
| 6    |                        |                     | 50-34-8518             | A-4455-AB 06 A(228) | 22-15-4064             | A-4455-AB 06A(P909) |                        |                     |
| 7    |                        |                     |                        |                     | 22-15-4074             | A-4455-AB 07A(P909) |                        |                     |
| 8    |                        |                     |                        |                     | 22-15-4084             | A-4455-AB 08A(P909) |                        |                     |
| 9    | 22-16-2096             | A-4455-AA 09 A(208) |                        |                     | 22-15-4094             | A-4455-AB 09A(P909) |                        |                     |
| 10   |                        |                     |                        |                     |                        |                     | 22-15-2102             | A-4455-AE 10A(P909) |
| 11   |                        |                     |                        |                     | 22-15-4114             | A-4455-AB 11A(P909) |                        |                     |
| 12   |                        |                     |                        |                     | 22-15-4124             | A-4455-AB 12A(P909) |                        |                     |
| 13   |                        |                     |                        |                     | 22-15-4134             | A-4455-AB 13A(P909) |                        |                     |
| 14   |                        |                     |                        |                     | 22-15-4144             | A-4455-AB 14A(P909) |                        |                     |
| 15   |                        |                     |                        |                     | 22-15-4154             | A-4455-AB 15A(P909) |                        |                     |
| 16   |                        |                     |                        |                     | 22-15-4164             | A-4455-AB 16A(P909) |                        |                     |
| 17   |                        |                     |                        |                     | 22-15-4174             | A-4455-AB 17A(P909) |                        |                     |
| 18   | 22-16-2186             | A-4455-AA 18 A(208) |                        |                     |                        |                     |                        |                     |
| 19   | 22-16-2196             | A-4455-AA 19 A(208) |                        |                     | 22-15-4194             | A-4455-AB 19A(P909) |                        |                     |
| 20   | 22-16-2206             | A-4455-AA 20 A(208) |                        |                     | 22-15-4204             | A-4455-AB 20A(P909) |                        |                     |
| 21   | 22-16-2216             | A-4455-AA 21 A(208) |                        |                     | 22-15-4214             | A-4455-AB 21A(P909) |                        |                     |
| 22   | 22-16-2226             | A-4455-AA 22 A(208) |                        |                     | 22-15-4224             | A-4455-AB 22A(P909) |                        |                     |
| 23   | 22-16-2236             | A-4455-AA 23 A(208) |                        |                     | 22-15-4234             | A-4455-AB 23A(P909) |                        |                     |
| 24   |                        |                     |                        |                     | 22-15-4244             | A-4455-AB 24A(P909) |                        |                     |
| 25   |                        |                     |                        |                     | 22-15-4254             | A-4455-AB 25A(P909) | 22-15-2252             | A-4455-AE 25A(P909) |

|   |  |              |  |   |  |                 |  |                 |  |                                    |  |   |  |  |  |   |  |  |  |   |  |  |  |   |  |  |  |
|---|--|--------------|--|---|--|-----------------|--|-----------------|--|------------------------------------|--|---|--|--|--|---|--|--|--|---|--|--|--|---|--|--|--|
| THIS DRAWING CONTAINS INFORMATION THAT IS PROPRIETARY TO MOLEX ELECTRONIC TECHNOLOGIES, LLC AND SHOULD NOT BE USED WITHOUT WRITTEN PERMISSION |  |              |  |   |  |                 |  |                 |  |                                    |  |   |  |  |  |   |  |  |  |   |  |  |  |   |  |  |  |
| DIMENSION UNITS   |  | SCALE        |  | CURRENT REV DESC: REMOVED OBSOLETE PART NUMBER AS PER PCN#512128.   |  |                 |  |                 |  | molex                              |  |   |  |  |  |   |  |  |  |   |  |  |  |   |  |  |  |
| MM/IN   |  | 1:1          |  |   |  |                 |  |                 |  |                                    |  |   |  |  |  |   |  |  |  |   |  |  |  |   |  |  |  |
| GENERAL TOLERANCES (UNLESS SPECIFIED)   |  |              |  | EC NO: 716046<br>DRWN: SANTHN 2022/07/22<br>CHKD: GGA 2022/07/29<br>APPR: GGA 2022/07/29<br>INITIAL REVISION:<br>DRWN: SAMIEC 1984/05/10<br>APPR: LENZ 1984/05/10 |  |                 |  |                 |  | KK 100 PCB ASSY<br>4455 SERIES DWG |  |   |  |  |  |   |  |  |  |   |  |  |  |   |  |  |  |
| 4 PLACES ±  |  | ±            |  |   |  |                 |  |                 |  |                                    |  |   |  |  |  |   |  |  |  |   |  |  |  |   |  |  |  |
| 3 PLACES ±  |  | ± 0.01       |  |   |  |                 |  |                 |  |                                    |  |   |  |  |  |   |  |  |  |   |  |  |  |   |  |  |  |
| 2 PLACES ±  |  | 0.25 ± 0.015 |  |   |  |                 |  |                 |  |                                    |  |   |  |  |  |   |  |  |  |   |  |  |  |   |  |  |  |
| 1 PLACE ±   |  | 0.36 ±       |  |   |  |                 |  |                 |  |                                    |  |   |  |  |  |   |  |  |  |   |  |  |  |   |  |  |  |
| 0 PLACES ±  |  | ±            |  | DOCUMENT NUMBER<br><b>SDA-4455</b>  |  | DOC TYPE<br>PSD |  | DOC PART<br>001 |  | REVISION<br>D18                    |  |   |  |  |  |   |  |  |  |   |  |  |  |   |  |  |  |
| ANGULAR TOL ± 0.5°  |  |              |  |   |  |                 |  |                 |  |                                    |  |   |  |  |  |   |  |  |  |   |  |  |  |   |  |  |  |
| DRAFT WHERE APPLICABLE MUST REMAIN WITHIN DIMENSIONS  |  |              |  | THIRD ANGLE PROJECTION  |  | DRAWING         |  | SERIES          |  | MATERIAL NUMBER                    |  |   |  |  |  |   |  |  |  |   |  |  |  |   |  |  |  |
|   |  |              |  |   |  | B-SIZE          |  | 4455            |  | CUSTOMER<br>GENERAL MARKET         |  |   |  |  |  |   |  |  |  |   |  |  |  |   |  |  |  |
| DOCUMENT STATUS   |  |              |  | P1  |  | RELEASE DATE    |  | 2022/07/29      |  | 12:32:02                           |  |   |  |  |  |   |  |  |  |   |  |  |  |   |  |  |  |
| 7   |  |              |  | 6   |  |                 |  | 5               |  |                                    |  | 4 |  |  |  | 3 |  |  |  | 2 |  |  |  | 1 |  |  |  |

# KK 100 PCB ASSY 2-25 CKT 4455 SERIES

| Ckts | Assy Proc: RIGHT ANGLE |                      | Assy Proc: RIGHT ANGLE |                     | Assy Proc: RIGHT ANGLE |                     | Assy Proc: RIGHT ANGLE |                 |
|------|------------------------|----------------------|------------------------|---------------------|------------------------|---------------------|------------------------|-----------------|
|      | Material No            | Engineer Number      | Material No            | Engineer Number     | Material No            | Engineer Number     | Material No            | Engineer Number |
| 2    | 22-15-4022             | A-4455-AR02A(P909)   |                        |                     | 22-17-5023             | A-4455-AZ02B(228)   |                        |                 |
| 3    | 22-15-4032             | A-4455-AR 03 A(P909) |                        |                     | 22-17-5033             | A-4455-AZ 03 B(228) |                        |                 |
| 4    | 22-15-4042             | A-4455-AR 04 A(P909) |                        |                     | 22-17-5043             | A-4455-AZ 04 B(228) |                        |                 |
| 5    | 22-15-4052             | A-4455-AR 05 A(P909) |                        |                     |                        |                     |                        |                 |
| 6    | 22-15-4062             | A-4455-AR 06 A(P909) |                        |                     | 22-17-5063             | A-4455-AZ 06 B(228) |                        |                 |
| 7    | 22-15-4072             | A-4455-AR 07 A(P909) |                        |                     | 22-17-5073             | A-4455-AZ 07 B(228) |                        |                 |
| 8    | 22-15-4082             | A-4455-AR 08 A(P909) |                        |                     | 22-17-5083             | A-4455-AZ 08 B(228) |                        |                 |
| 9    | 22-15-4092             | A-4455-AR 09 A(P909) |                        |                     | 22-17-5093             | A-4455-AZ 09 B(228) |                        |                 |
| 10   | 22-15-4102             | A-4455-AR 10 A(P909) |                        |                     | 22-17-5103             | A-4455-AZ 10 B(228) |                        |                 |
| 11   | 22-15-4112             | A-4455-AR 11 A(P909) |                        |                     | 22-17-5113             | A-4455-AZ 11 B(228) |                        |                 |
| 12   | 22-15-4122             | A-4455-AR 12 A(P909) |                        |                     | 22-17-5123             | A-4455-AZ 12 B(228) |                        |                 |
| 13   | 22-15-4132             | A-4455-AR 13 A(P909) |                        |                     | 22-17-5133             | A-4455-AZ 13 B(228) |                        |                 |
| 14   | 22-15-4142             | A-4455-AR 14 A(P909) |                        |                     | 22-17-5143             | A-4455-AZ 14 B(228) |                        |                 |
| 15   | 22-15-4152             | A-4455-AR 15 A(P909) |                        |                     | 22-17-5153             | A-4455-AZ 15 B(228) |                        |                 |
| 16   | 22-15-4162             | A-4455-AR 16 A(P909) |                        |                     | 22-17-5163             | A-4455-AZ 16 B(228) |                        |                 |
| 17   | 22-15-4172             | A-4455-AR 17 A(P909) |                        |                     | 22-17-5173             | A-4455-AZ 17 B(228) |                        |                 |
| 18   | 22-15-4182             | A-4455-AR 18 A(P909) |                        |                     | 22-17-5183             | A-4455-AZ 18 B(228) |                        |                 |
| 19   | 22-15-4192             | A-4455-AR 19 A(P909) |                        |                     | 22-17-5193             | A-4455-AZ 19 B(228) |                        |                 |
| 20   | 22-15-4202             | A-4455-AR 20 A(P909) | 22-17-5201             | A-4455-AZ 20 A(228) | 22-17-5203             | A-4455-AZ 20 B(228) |                        |                 |
| 21   | 22-15-4212             | A-4455-AR 21 A(P909) |                        |                     | 22-17-5213             | A-4455-AZ 21 B(228) |                        |                 |
| 22   | 22-15-4222             | A-4455-AR 22 A(P909) |                        |                     | 22-17-5223             | A-4455-AZ 22 B(228) |                        |                 |
| 23   | 22-15-4232             | A-4455-AR 23 A(P909) |                        |                     | 22-17-5233             | A-4455-AZ 23 B(228) |                        |                 |
| 24   | 22-15-4242             | A-4455-AR 24 A(P909) |                        |                     | 22-17-5243             | A-4455-AZ 24 B(228) |                        |                 |
| 25   | 22-15-4252             | A-4455-AR 25 A(P909) |                        |                     | 22-17-5253             | A-4455-AZ 25 B(228) |                        |                 |

|   |  |                     |  |   |  |                        |  |              |  |                          |  |
|---|--|---------------------|--|---|--|------------------------|--|--------------|--|--------------------------|--|
| THIS DRAWING CONTAINS INFORMATION THAT IS PROPRIETARY TO MOLEX ELECTRONIC TECHNOLOGIES, LLC AND SHOULD NOT BE USED WITHOUT WRITTEN PERMISSION |  |                     |  |   |  |                        |  |              |  |                          |  |
| DIMENSION UNITS<br><b>MM/IN</b>   |  | SCALE<br><b>1:1</b> |  | CURRENT REV DESC: REMOVED OBSOLETE PART NUMBER AS PER PCN#512128. |  |                        |  | molex        |  |                          |  |
| GENERAL TOLERANCES (UNLESS SPECIFIED)   |  |                     |  |   |  | EC NO: 716046          |  | DRWN: SANTHN |  | 2022/07/22               |  |
| 4 PLACES ±  |  | MM                  |  | INCH  |  | CHKD: GGA              |  | 2022/07/29   |  | 2022/07/29               |  |
| 3 PLACES ±  |  | 0.25                |  | 0.015   |  | APPR: GGA              |  | 2022/07/29   |  | PRODUCT CUSTOMER DRAWING |  |
| 2 PLACES ±  |  | 0.36                |  | ±   |  | INITIAL REVISION:      |  | DRWN: SAMIEC |  | 1984/05/10               |  |
| 1 PLACE ±   |  | 0.5                 |  | °   |  | APPR: LENZ             |  | 1984/05/10   |  | DOCUMENT NUMBER          |  |
| ANGULAR TOL ±   |  | 0.5                 |  | °   |  | THIRD ANGLE PROJECTION |  | DRAWING      |  | SERIES                   |  |
| DRAFT WHERE APPLICABLE MUST REMAIN WITHIN DIMENSIONS  |  | B-SIZE              |  | 4455  |  | MATERIAL NUMBER        |  | CUSTOMER     |  | SHEET NUMBER             |  |
| SEE CHART   |  | GENERAL MARKET      |  | 8 OF 15   |  | SDA-4455               |  | PSD          |  | 001 D18                  |  |



# KK 100 PCB ASSY 2-25 CKT

## 4455 SERIES

| Ckts | Assy Proc: BOTTOM ENTRY |                   | Assy Proc: BOTTOM ENTRY |                     | Assy Proc: BOTTOM ENTRY |                   | Assy Proc: BOTTOM ENTRY |                   |
|------|-------------------------|-------------------|-------------------------|---------------------|-------------------------|-------------------|-------------------------|-------------------|
|      | Material No             | Engineer Number   | Material No             | Engineer Number     | Material No             | Engineer Number   | Material No             | Engineer Number   |
| 2    | 22-17-2024              | A-4455-BH02D(228) |                         |                     |                         |                   | 22-17-2027              | A-4455-BH02J(228) |
| 3    | 22-17-2034              | A-4455-BH03D(228) |                         |                     |                         |                   | 22-17-2037              | A-4455-BH03J(228) |
| 4    | 22-17-2044              | A-4455-BH04D(228) |                         |                     |                         |                   | 22-17-2047              | A-4455-BH04J(228) |
| 5    | 22-17-2054              | A-4455-BH05D(228) |                         |                     | 22-17-3056              | A-4455-BH05D(228) | 22-17-2057              | A-4455-BH05J(228) |
| 6    | 22-17-2064              | A-4455-BH06D(228) |                         |                     | 22-17-3066              | A-4455-BH06D(228) | 22-17-2067              | A-4455-BH06J(228) |
| 7    | 22-17-2074              | A-4455-BH07D(228) |                         |                     |                         |                   | 22-17-2077              | A-4455-BH07J(228) |
| 8    | 22-17-2084              | A-4455-BH08D(228) |                         |                     | 22-17-3086              | A-4455-BH08D(228) | 22-17-2087              | A-4455-BH08J(228) |
| 9    | 22-17-2094              | A-4455-BH09D(228) |                         |                     |                         |                   | 22-17-2097              | A-4455-BH09J(228) |
| 10   | 22-17-2104              | A-4455-BH10D(228) |                         |                     |                         |                   | 22-17-2107              | A-4455-BH10J(228) |
| 11   | 22-17-2114              | A-4455-BH11D(228) |                         |                     |                         |                   | 22-17-2117              | A-4455-BH11J(228) |
| 12   | 22-17-2124              | A-4455-BH12D(228) |                         |                     |                         |                   | 22-17-2127              | A-4455-BH12J(228) |
| 13   | 22-17-2134              | A-4455-BH13D(228) |                         |                     |                         |                   | 22-17-2137              | A-4455-BH13J(228) |
| 14   | 22-17-2144              | A-4455-BH14D(228) | 22-17-2140              | A-4455-BH 14 D(231) | 22-17-3146              | A-4455-BH14D(228) | 22-17-2147              | A-4455-BH14J(228) |
| 15   |                         |                   |                         |                     |                         |                   | 22-17-2157              | A-4455-BH15J(228) |
| 16   | 22-17-2164              | A-4455-BH16D(228) |                         |                     |                         |                   | 22-17-2167              | A-4455-BH16J(228) |
| 17   |                         |                   |                         |                     |                         |                   | 22-17-2177              | A-4455-BH17J(228) |
| 18   | 22-17-2184              | A-4455-BH18D(228) |                         |                     |                         |                   | 22-17-2187              | A-4455-BH18J(228) |
| 19   | 22-17-2194              | A-4455-BH19D(228) |                         |                     | 22-17-3196              | A-4455-BH19D(228) | 22-17-2197              | A-4455-BH19J(228) |
| 20   | 22-17-2204              | A-4455-BH20D(228) | 22-17-2200              | A-4455-BH 20 D(231) | 22-17-3206              | A-4455-BH20D(228) | 22-17-2207              | A-4455-BH20J(228) |
| 21   | 22-17-2214              | A-4455-BH21D(228) |                         |                     |                         |                   |                         |                   |
| 22   | 22-17-2224              | A-4455-BH22D(228) |                         |                     |                         |                   |                         |                   |
| 23   | 22-17-2234              | A-4455-BH23D(228) |                         |                     |                         |                   |                         |                   |
| 24   | 22-17-2244              | A-4455-BH24D(228) |                         |                     |                         |                   |                         |                   |
| 25   | 22-17-2254              | A-4455-BH25D(228) | 22-17-2250              | A-4455-BH 25 D(231) | 22-17-3256              | A-4455-BH25D(228) |                         |                   |

|   |                     |   |         |           |                                    |          |     |         |     |
|---|---------------------|---|---------|-----------|------------------------------------|----------|-----|---------|-----|
| THIS DRAWING CONTAINS INFORMATION THAT IS PROPRIETARY TO MOLEX ELECTRONIC TECHNOLOGIES, LLC AND SHOULD NOT BE USED WITHOUT WRITTEN PERMISSION |                     |   |         |           |                                    |          |     |         |     |
| DIMENSION UNITS<br><b>MM/IN</b>   | SCALE<br><b>1:1</b> | CURRENT REV DESC: REMOVED OBSOLETE PART NUMBER AS PER PCN#512128. |         |           | molex                              |          |     |         |     |
| GENERAL TOLERANCES (UNLESS SPECIFIED)   |                     | EC NO: 716046   |         |           | KK 100 PCB ASSY<br>4455 SERIES DWG |          |     |         |     |
| 4 PLACES ±  |                     | DRWN: SANTHN 2022/07/22   |         |           |                                    |          |     |         |     |
| 3 PLACES ±  |                     | CHKD: GGA 2022/07/29  |         |           | PRODUCT CUSTOMER DRAWING           |          |     |         |     |
| 2 PLACES ± 0.25 ± 0.015   |                     | APPR: GGA 2022/07/29  |         |           | DOCUMENT NUMBER                    |          |     |         |     |
| 1 PLACE ± 0.36 ±  |                     | INITIAL REVISION:   |         |           | SDA-4455                           |          |     |         |     |
| 0 PLACES ±  |                     | DRWN: SAMIEC 1984/05/10   |         |           | PSD                                |          | 001 |         | D18 |
| ANGULAR TOL ± 0.5°  |                     | APPR: LENZ 1984/05/10   |         |           | SHEET NUMBER                       |          |     |         |     |
| DRAFT WHERE APPLICABLE MUST REMAIN WITHIN DIMENSIONS  |                     | THIRD ANGLE PROJECTION  | DRAWING | SERIES    | MATERIAL NUMBER                    | CUSTOMER |     | 9 OF 15 |     |
|   |                     | B-SIZE  | 4455    | SEE CHART | GENERAL MARKET                     |          |     |         |     |

# KK 100 PCB ASSY 2-25 CKT 4455 SERIES

| Ckts | Assy Proc: TOP ENTRY |                     | Assy Proc: TOP ENTRY |                     | Assy Proc: TOP ENTRY |                     | Assy Proc: TOP ENTRY |                     |
|------|----------------------|---------------------|----------------------|---------------------|----------------------|---------------------|----------------------|---------------------|
|      |                      | Hooks Cut:          | YES                  | Hooks Cut:          | YES                  | Hooks Cut:          | YES                  | Hooks Cut:          |
|      | Housing No:          | 4455-NR             | Housing No:          | 4455-N              | Housing No:          | 4455-N              | Housing No:          | 4455-BN             |
|      | Terminal No:         | 4316-4(208)         | Terminal No:         | 4316-4(565)         | Terminal No:         | 4316-4(P909)        | Terminal No:         | 4316-4(P909)        |
|      | Dim C:               | 3.35 / .132         | Dim C:               | 3.35 / .132         | Dim C:               | 3.35 / .132         | Dim C:               | 3.35 / .132         |
|      | Plating:             | 208                 | Plating:             | 565                 | Plating:             | P909                | Plating:             | P909                |
|      | Packaging:           | PK-44646-003        | Packaging:           | PK-44646-003        | Packaging:           | PK-44646-003        | Packaging:           | PK-44646-002        |
|      | Voids:               | NO                  | Voids:               | NO                  | Voids:               | NO                  | Voids:               | NO                  |
|      |                      |                     |                      |                     |                      |                     |                      |                     |
|      | Material No          | Engineer Number     | Material No          | Engineer Number     | Material No          | Engineer Number     | Material No          | Engineer Number     |
| 2    |                      |                     | 22-18-2026           | A-4455-CY02A(565)   | 22-02-7023           | A-4455-CY02A(P909)  | 22-15-4028           | A-4455-CB02A(P909)  |
| 3    |                      |                     | 22-18-2036           | A-4455-CY 03 A(565) | 22-02-7033           | A-4455-CY 03A(P909) | 22-15-4038           | A-4455-CB 03A(P909) |
| 4    |                      |                     | 22-18-2046           | A-4455-CY 04 A(565) | 22-02-7043           | A-4455-CY 04A(P909) | 22-15-4048           | A-4455-CB 04A(P909) |
| 5    | 22-18-2057           | A-4455-CP 05 A(208) |                      |                     | 22-02-7053           | A-4455-CY 05A(P909) | 22-15-4058           | A-4455-CB 05A(P909) |
| 6    |                      |                     | 22-18-2066           | A-4455-CY 06 A(565) | 22-02-7063           | A-4455-CY 06A(P909) | 22-15-4068           | A-4455-CB 06A(P909) |
| 7    |                      |                     |                      |                     | 22-02-7073           | A-4455-CY 07A(P909) | 22-15-4078           | A-4455-CB 07A(P909) |
| 8    |                      |                     |                      |                     | 22-02-7083           | A-4455-CY 08A(P909) | 22-15-4088           | A-4455-CB 08A(P909) |
| 9    |                      |                     |                      |                     | 22-02-7093           | A-4455-CY 09A(P909) | 22-15-4098           | A-4455-CB 09A(P909) |
| 10   |                      |                     |                      |                     | 22-02-7103           | A-4455-CY 10A(P909) | 22-15-4108           | A-4455-CB 10A(P909) |
| 11   |                      |                     |                      |                     | 22-02-7113           | A-4455-CY 11A(P909) | 22-15-4118           | A-4455-CB 11A(P909) |
| 12   |                      |                     | 22-18-2126           | A-4455-CY 12 A(565) | 22-02-7123           | A-4455-CY 12A(P909) | 22-15-4128           | A-4455-CB 12A(P909) |
| 13   |                      |                     |                      |                     | 22-02-7133           | A-4455-CY 13A(P909) | 22-15-4138           | A-4455-CB 13A(P909) |
| 14   |                      |                     | 22-18-2146           | A-4455-CY 14 A(565) | 22-02-7143           | A-4455-CY 14A(P909) | 22-15-4148           | A-4455-CB 14A(P909) |
| 15   |                      |                     | 22-18-2156           | A-4455-CY 15 A(565) | 22-02-7153           | A-4455-CY 15A(P909) | 22-15-4158           | A-4455-CB 15A(P909) |
| 16   |                      |                     | 22-18-2166           | A-4455-CY 16 A(565) | 22-02-7163           | A-4455-CY 16A(P909) | 22-15-4168           | A-4455-CB 16A(P909) |
| 17   |                      |                     | 22-18-2176           | A-4455-CY 17 A(565) | 22-02-7173           | A-4455-CY 17A(P909) | 22-15-4178           | A-4455-CB 17A(P909) |
| 18   |                      |                     | 22-18-2186           | A-4455-CY 18 A(565) | 22-02-7183           | A-4455-CY 18A(P909) |                      |                     |
| 19   |                      |                     | 22-18-2196           | A-4455-CY 19 A(565) | 22-02-7193           | A-4455-CY 19A(P909) | 22-15-4198           | A-4455-CB 19A(P909) |
| 20   |                      |                     | 22-18-2206           | A-4455-CY 20 A(565) | 22-02-7203           | A-4455-CY 20A(P909) | 22-15-4208           | A-4455-CB 20A(P909) |
| 21   |                      |                     | 22-18-2216           | A-4455-CY 21 A(565) | 22-02-7213           | A-4455-CY 21A(P909) | 22-15-4218           | A-4455-CB 21A(P909) |
| 22   |                      |                     | 22-18-2226           | A-4455-CY 22 A(565) | 22-02-7223           | A-4455-CY 22A(P909) | 22-15-4228           | A-4455-CB 22A(P909) |
| 23   |                      |                     | 22-18-2236           | A-4455-CY 23 A(565) | 22-02-7233           | A-4455-CY 23A(P909) | 22-15-4238           | A-4455-CB 23A(P909) |
| 24   |                      |                     | 22-18-2246           | A-4455-CY 24 A(565) |                      |                     | 22-15-4248           | A-4455-CB 24A(P909) |
| 25   |                      |                     | 22-18-2256           | A-4455-CY 25 A(565) |                      |                     | 22-15-4258           | A-4455-CB 25A(P909) |

|   |                     |   |  |  |                                    |         |          |                 |                |              |
|---|---------------------|---|--|--|------------------------------------|---------|----------|-----------------|----------------|--------------|
| THIS DRAWING CONTAINS INFORMATION THAT IS PROPRIETARY TO MOLEX ELECTRONIC TECHNOLOGIES, LLC AND SHOULD NOT BE USED WITHOUT WRITTEN PERMISSION |                     |   |  |  |                                    |         |          |                 |                |              |
| DIMENSION UNITS<br><b>MM/IN</b>   | SCALE<br><b>1:1</b> | CURRENT REV DESC: REMOVED OBSOLETE PART NUMBER AS PER PCN#512128. |  |  | molex                              |         |          |                 |                |              |
| GENERAL TOLERANCES (UNLESS SPECIFIED)   |                     |   |  |  | KK 100 PCB ASSY<br>4455 SERIES DWG |         |          |                 |                |              |
|   |                     |   |  |  | PRODUCT CUSTOMER DRAWING           |         |          |                 |                |              |
|   |                     |   |  |  | DOCUMENT NUMBER                    |         | DOC TYPE |                 | DOC PART       | REVISION     |
|   |                     |   |  |  | SDA-4455                           |         | PSD      | 001             | D18            |              |
| DRWN: SAMIEC 1984/05/10<br>APPR: LENZ 1984/05/10  |                     |   |  |  | THIRD ANGLE PROJECTION             | DRAWING | SERIES   | MATERIAL NUMBER | CUSTOMER       | SHEET NUMBER |
| DRAFT WHERE APPLICABLE<br>MUST REMAIN WITHIN DIMENSIONS   |                     |   |  |  |                                    | B-SIZE  | 4455     | SEE CHART       | GENERAL MARKET | 10 OF 15     |

# KK 100 PCB ASSY 2-25 CKT 4455 SERIES

| Ckts | Assy Proc: TOP ENTRY |                     | Assy Proc: TOP ENTRY |                     | Assy Proc: TOP ENTRY |                     | Assy Proc: TOP ENTRY     |                     |
|------|----------------------|---------------------|----------------------|---------------------|----------------------|---------------------|--------------------------|---------------------|
|      | Material No          | Engineer Number     | Material No          | Engineer Number     | Material No          | Engineer Number     | Material No              | Engineer Number     |
| 2    | 22-65-3020           | A-4455-CR02A(P909)  |                      |                     | 22-18-7023           | A-4455-CY02A(208)   | 22-18-7021               | A-4455-CY02B(228)   |
| 3    | 22-65-3030           | A-4455-CR 03A(P909) |                      |                     | 22-18-7033           | A-4455-CY 03 A(208) | 22-18-7031<br>38-00-1478 | A-4455-CY 03 B(228) |
| 4    | 22-65-3040           | A-4455-CR 04A(P909) |                      |                     | 22-18-7043           | A-4455-CY 04 A(208) | 22-18-7041               | A-4455-CY 04 B(228) |
| 5    | 22-65-3050           | A-4455-CR 05A(P909) |                      |                     | 22-18-7053           | A-4455-CY 05 A(208) | 22-18-7051               | A-4455-CY 05 B(228) |
| 6    | 22-65-3060           | A-4455-CR 06A(P909) |                      |                     | 22-18-7063           | A-4455-CY 06 A(208) | 22-18-7061               | A-4455-CY 06 B(228) |
| 7    | 22-65-3070           | A-4455-CR 07A(P909) |                      |                     | 22-18-7073           | A-4455-CY 07 A(208) | 22-18-7071               | A-4455-CY 07 B(228) |
| 8    | 22-65-3080           | A-4455-CR 08A(P909) |                      |                     | 22-18-7083           | A-4455-CY 08 A(208) | 22-18-7081               | A-4455-CY 08 B(228) |
| 9    | 22-65-3090           | A-4455-CR 09A(P909) |                      |                     | 22-18-7093           | A-4455-CY 09 A(208) | 22-18-7091               | A-4455-CY 09 B(228) |
| 10   | 22-65-3100           | A-4455-CR 10A(P909) |                      |                     | 22-18-7103           | A-4455-CY 10 A(208) | 22-18-7101               | A-4455-CY 10 B(228) |
| 11   | 22-65-3110           | A-4455-CR 11A(P909) |                      |                     | 22-18-7113           | A-4455-CY 11 A(208) | 22-18-7111               | A-4455-CY 11 B(228) |
| 12   | 22-65-3120           | A-4455-CR 12A(P909) | 22-18-2124           | A-4455-CZ 12 B(228) | 22-18-7123           | A-4455-CY 12 A(208) | 22-18-7121               | A-4455-CY 12 B(228) |
| 13   | 22-65-3130           | A-4455-CR 13A(P909) |                      |                     | 22-18-7133           | A-4455-CY 13 A(208) | 22-18-7131               | A-4455-CY 13 B(228) |
| 14   | 22-65-3140           | A-4455-CR 14A(P909) |                      |                     | 22-18-7143           | A-4455-CY 14 A(208) | 22-18-7141               | A-4455-CY 14 B(228) |
| 15   | 22-65-3150           | A-4455-CR 15A(P909) |                      |                     | 22-18-7153           | A-4455-CY 15 A(208) | 22-18-7151               | A-4455-CY 15 B(228) |
| 16   | 22-65-3160           | A-4455-CR 16A(P909) | 22-18-2164           | A-4455-CZ 16 B(228) | 22-18-7163           | A-4455-CY 16 A(208) | 22-18-7161               | A-4455-CY 16 B(228) |
| 17   | 22-65-3170           | A-4455-CR 17A(P909) |                      |                     | 22-18-7173           | A-4455-CY 17 A(208) | 22-18-7171               | A-4455-CY 17 B(228) |
| 18   | 22-65-3180           | A-4455-CR 18A(P909) |                      |                     | 22-18-7183           | A-4455-CY 18 A(208) | 22-18-7181               | A-4455-CY 18 B(228) |
| 19   | 22-65-3190           | A-4455-CR 19A(P909) | 22-18-2194           | A-4455-CZ 19 B(228) | 22-18-7193           | A-4455-CY 19 A(208) | 22-18-7191               | A-4455-CY 19 B(228) |
| 20   | 22-65-3200           | A-4455-CR 20A(P909) |                      |                     | 22-18-7203           | A-4455-CY 20 A(208) | 22-18-7201               | A-4455-CY 20 B(228) |
| 21   | 22-65-3210           | A-4455-CR 21A(P909) |                      |                     | 22-18-7213           | A-4455-CY 21 A(208) | 22-18-7211               | A-4455-CY 21 B(228) |
| 22   | 22-65-3220           | A-4455-CR 22A(P909) |                      |                     | 22-18-7223           | A-4455-CY 22 A(208) | 22-18-7221               | A-4455-CY 22 B(228) |
| 23   | 22-65-3230           | A-4455-CR 23A(P909) |                      |                     | 22-18-7233           | A-4455-CY 23 A(208) | 22-18-7231               | A-4455-CY 23 B(228) |
| 24   | 22-65-3240           | A-4455-CR 24A(P909) |                      |                     | 22-18-7243           | A-4455-CY 24 A(208) |                          |                     |
| 25   | 22-65-3250           | A-4455-CR 25A(P909) |                      |                     | 22-18-7253           | A-4455-CY 25 A(208) | 22-18-7251               | A-4455-CY 25 B(228) |

|   |  |                     |  |   |  |                    |  |                        |  |              |  |
|---|--|---------------------|--|---|--|--------------------|--|------------------------|--|--------------|--|
| THIS DRAWING CONTAINS INFORMATION THAT IS PROPRIETARY TO MOLEX ELECTRONIC TECHNOLOGIES, LLC AND SHOULD NOT BE USED WITHOUT WRITTEN PERMISSION |  |                     |  |   |  |                    |  |                        |  |              |  |
| DIMENSION UNITS<br><b>MM/IN</b>   |  | SCALE<br><b>1:1</b> |  | CURRENT REV DESC: REMOVED OBSOLETE PART NUMBER AS PER PCN#512128. |  |                    |  | molex                  |  |              |  |
| GENERAL TOLERANCES (UNLESS SPECIFIED)   |  |                     |  |   |  | EC NO: 716046      |  | DRWN: SANTHN           |  | 2022/07/22   |  |
| 4 PLACES ±  |  |                     |  |   |  | DRWN: GGA          |  | CHKD: GGA              |  | 2022/07/29   |  |
| 3 PLACES ±  |  |                     |  |   |  | APPR: GGA          |  | APPR: GGA              |  | 2022/07/29   |  |
| 2 PLACES ± 0.25 ± 0.015   |  |                     |  |   |  | INITIAL REVISION:  |  | DRWN: SAMIEC           |  | 1984/05/10   |  |
| 1 PLACE ± 0.36 ±  |  |                     |  |   |  | DRWN: LENZ         |  | APPR: LENZ             |  | 1984/05/10   |  |
| 0 PLACES ±  |  |                     |  |   |  | ANGULAR TOL ± 0.5° |  | THIRD ANGLE PROJECTION |  | DRAWING      |  |
| DRAFT WHERE APPLICABLE MUST REMAIN WITHIN DIMENSIONS  |  |                     |  |   |  | SERIES             |  | MATERIAL NUMBER        |  | CUSTOMER     |  |
|   |  |                     |  |   |  | B-SIZE             |  | 4455                   |  | SEE CHART    |  |
|   |  |                     |  |   |  | 11 OF 15           |  | GENERAL MARKET         |  | SHEET NUMBER |  |

# KK 100 PCB ASSY 2-25 CKT 4455 SERIES

| Ckts | Assy Proc: RIGHT ANGLE |                    | Assy Proc: BOTTOM ENTRY |                    | Assy Proc: RIGHT ANGLE |                      | Assy Proc: RIGHT ANGLE |                     |
|------|------------------------|--------------------|-------------------------|--------------------|------------------------|----------------------|------------------------|---------------------|
|      | Material No            | Engineer Number    | Material No             | Engineer Number    | Material No            | Engineer Number      | Material No            | Engineer Number     |
| 2    | 38-00-1332             | A-4455-AZ02C(P909) | 38-00-1392              | A-4455-BH02F(P909) |                        |                      |                        |                     |
| 3    | 38-00-1333             | A-4455-AZ03C(P909) | 38-00-1393              | A-4455-BH03F(P909) |                        |                      |                        |                     |
| 4    | 38-00-1334             | A-4455-AZ04C(P909) | 38-00-1394              | A-4455-BH04F(P909) |                        |                      |                        |                     |
| 5    | 38-00-1335             | A-4455-AZ05C(P909) | 38-00-1395              | A-4455-BH05F(P909) |                        |                      |                        |                     |
| 6    | 38-00-1336             | A-4455-AZ06C(P909) | 38-00-1396              | A-4455-BH06F(P909) |                        |                      |                        |                     |
| 7    | 38-00-1337             | A-4455-AZ07C(P909) | 38-00-1397              | A-4455-BH07F(P909) | 22-14-2079             | A-4455-AA07B(P909)   | 22-14-2077             | A-4455-AA07A(565)   |
| 8    | 38-00-1338             | A-4455-AZ08C(P909) | 38-00-1398              | A-4455-BH08F(P909) | 22-14-2089             | A-4455-AA 08 B(P909) | 22-14-2087             | A-4455-AA 08 A(565) |
| 9    | 38-00-1339             | A-4455-AZ09C(P909) | 38-00-1399              | A-4455-BH09F(P909) | 22-14-2099             | A-4455-AA 09 B(P909) | 22-14-2097             | A-4455-AA 09 A(565) |
| 10   | 38-00-1340             | A-4455-AZ10C(P909) | 38-00-1400              | A-4455-BH10F(P909) | 22-14-2109             | A-4455-AA 10 B(P909) | 22-14-2107             | A-4455-AA 10 A(565) |
| 11   | 38-00-1341             | A-4455-AZ11C(P909) | 38-00-1401              | A-4455-BH11F(P909) | 22-14-2119             | A-4455-AA 11 B(P909) | 22-14-2117             | A-4455-AA 11 A(565) |
| 12   | 38-00-1342             | A-4455-AZ12C(P909) | 38-00-1402              | A-4455-BH12F(P909) | 22-14-2129             | A-4455-AA 12 B(P909) | 22-14-2127             | A-4455-AA 12 A(565) |
| 13   | 38-00-1343             | A-4455-AZ13C(P909) | 38-00-1403              | A-4455-BH13F(P909) | 22-14-2139             | A-4455-AA 13 B(P909) | 22-14-2137             | A-4455-AA 13 A(565) |
| 14   | 38-00-1344             | A-4455-AZ14C(P909) | 38-00-1404              | A-4455-BH14F(P909) | 22-14-2149             | A-4455-AA 14 B(P909) | 22-14-2147             | A-4455-AA 14 A(565) |
| 15   | 38-00-1345             | A-4455-AZ15C(P909) | 38-00-1405              | A-4455-BH15F(P909) | 22-14-2159             | A-4455-AA 15 B(P909) | 22-14-2157             | A-4455-AA 15 A(565) |
| 16   | 38-00-1346             | A-4455-AZ16C(P909) | 38-00-1406              | A-4455-BH16F(P909) | 22-14-2169             | A-4455-AA 16 B(P909) | 22-14-2167             | A-4455-AA 16 A(565) |
| 17   | 38-00-1347             | A-4455-AZ17C(P909) | 38-00-1407              | A-4455-BH17F(P909) | 22-14-2179             | A-4455-AA 17 B(P909) | 22-14-2177             | A-4455-AA 17 A(565) |
| 18   | 38-00-1348             | A-4455-AZ18C(P909) | 38-00-1408              | A-4455-BH18F(P909) | 22-14-2189             | A-4455-AA 18 B(P909) | 22-14-2187             | A-4455-AA 18 A(565) |
| 19   | 38-00-1349             | A-4455-AZ19C(P909) | 38-00-1409              | A-4455-BH19F(P909) | 22-14-2199             | A-4455-AA 19 B(P909) | 22-14-2197             | A-4455-AA 19 A(565) |
| 20   | 38-00-1350             | A-4455-AZ20C(P909) | 38-00-1410              | A-4455-BH20F(P909) | 22-14-2209             | A-4455-AA 20 B(P909) | 22-14-2207             | A-4455-AA 20 A(565) |
| 21   |                        |                    |                         |                    | 22-14-2219             | A-4455-AA 21 B(P909) | 22-14-2217             | A-4455-AA 21 A(565) |
| 22   |                        |                    |                         |                    | 22-14-2229             | A-4455-AA 22 B(P909) | 22-14-2227             | A-4455-AA 22 A(565) |
| 23   |                        |                    |                         |                    | 22-14-2239             | A-4455-AA 23 B(P909) | 22-14-2237             | A-4455-AA 23 A(565) |
| 24   |                        |                    |                         |                    | 22-14-2249             | A-4455-AA 24 B(P909) | 22-14-2247             | A-4455-AA 24 A(565) |
| 25   |                        |                    |                         |                    | 22-14-2259             | A-4455-AA 25 B(P909) | 22-14-2257             | A-4455-AA 25 A(565) |

|   |       |   |       |   |  |                 |  |                |  |              |  |  |
|---|-------|---|-------|---|--|-----------------|--|----------------|--|--------------|--|--|
| THIS DRAWING CONTAINS INFORMATION THAT IS PROPRIETARY TO MOLEX ELECTRONIC TECHNOLOGIES, LLC AND SHOULD NOT BE USED WITHOUT WRITTEN PERMISSION |       |   |       |   |  |                 |  |                |  |              |  |  |
| DIMENSION UNITS   | SCALE | CURRENT REV DESC: REMOVED OBSOLETE PART NUMBER AS PER PCN#512128. |       |   |  |                 |  |                |  |              |  |  |
| MM/IN   | 1:1   | <b>molex</b>  |       |   |  |                 |  |                |  |              |  |  |
| GENERAL TOLERANCES (UNLESS SPECIFIED)   |       | KK 100 PCB ASSY<br>4455 SERIES DWG                                |       |   |  |                 |  |                |  |              |  |  |
|   |       | PRODUCT CUSTOMER DRAWING  |       |   |  |                 |  |                |  |              |  |  |
| 4 PLACES  | ±     |   |       | EC NO: 716046<br>DRWN: SANTHN<br>CHKD: GGA<br>APPR: GGA |  |                 |  |                |  |              |  | 2022/07/22<br>2022/07/29<br>2022/07/29 |
| 3 PLACES  | ±     |   | 0.01  | INITIAL REVISION:                                       |  |                 |  |                |  |              |  | 2022/07/29                             |
| 2 PLACES  | ±     | 0.25  | 0.015 | DRWN: SAMIEC<br>APPR: LENZ                              |  |                 |  |                |  |              |  | 1984/05/10<br>1984/05/10               |
| 1 PLACE   | ±     | 0.36  |       | DOCUMENT NUMBER   |  |                 |  |                |  |              |  | 2022/07/29                             |
| 0 PLACES  | ±     |   |       | SDA-4455  |  |                 |  |                |  |              |  | PSD 001 D18                            |
| ANGULAR TOL ± 0.5°  |       | THIRD ANGLE PROJECTION  |       |   |  |                 |  |                |  |              |  |  |
| DRAFT WHERE APPLICABLE MUST REMAIN WITHIN DIMENSIONS  |       | DRAWING   |       | SERIES  |  | MATERIAL NUMBER |  | CUSTOMER       |  | SHEET NUMBER |  |  |
|   |       | B-SIZE  |       | 4455  |  | SEE CHART       |  | GENERAL MARKET |  | 12 OF 15     |  |  |

# KK 100 PCB ASSY 2-25 CKT

## 4455 SERIES

| Ckts | Assy Proc: RIGHT ANGLE |                      | Assy Proc: RIGHT ANGLE |                     | Assy Proc: TOP ENTRY |                    | Assy Proc: TOP ENTRY |                      |
|------|------------------------|----------------------|------------------------|---------------------|----------------------|--------------------|----------------------|----------------------|
|      | Material No            | Engineer Number      | Material No            | Engineer Number     | Material No          | Engineer Number    | Material No          | Engineer Number      |
| 2    |                        |                      | 22-16-3028             | A-4455-AB02A(565)   | 38-00-1422           | A-4455-CZ02C(P909) |                      |                      |
| 3    |                        |                      | 22-16-3038             | A-4455-AB 03 A(565) | 38-00-1423           | A-4455-CZ03C(P909) |                      |                      |
| 4    |                        |                      | 22-16-3048             | A-4455-AB 04 A(565) | 38-00-1424           | A-4455-CZ04C(P909) |                      |                      |
| 5    |                        |                      | 22-16-3058             | A-4455-AB 05 A(565) | 38-00-1425           | A-4455-CZ05C(P909) |                      |                      |
| 6    |                        |                      | 22-16-3068             | A-4455-AB 06 A(565) | 38-00-1426           | A-4455-CZ06C(P909) | 22-02-3068           | A-4455-CW06A(P909)-2 |
| 7    | 22-14-3617             | A-4455-AA07T(P909)   | 22-16-3078             | A-4455-AB 07 A(565) | 38-00-1427           | A-4455-CZ07C(P909) | 50-29-0004           | A-4455-CW07A(P909)-2 |
| 8    | 22-14-3618             | A-4455-AA 08 T(P909) | 22-16-3088             | A-4455-AB 08 A(565) | 38-00-1428           | A-4455-CZ08C(P909) |                      |                      |
| 9    | 22-14-3619             | A-4455-AA 09 T(P909) | 22-16-3098             | A-4455-AB 09 A(565) | 38-00-1429           | A-4455-CZ09C(P909) |                      |                      |
| 10   | 22-14-3711             | A-4455-AA 10 T(P909) | 22-16-3108             | A-4455-AB 10 A(565) | 38-00-1430           | A-4455-CZ10C(P909) |                      |                      |
| 11   | 22-14-3712             | A-4455-AA 11 T(P909) | 22-16-3118             | A-4455-AB 11 A(565) | 38-00-1431           | A-4455-CZ11C(P909) |                      |                      |
| 12   | 22-14-3713             | A-4455-AA 12 T(P909) | 22-16-3128             | A-4455-AB 12 A(565) | 38-00-1432           | A-4455-CZ12C(P909) |                      |                      |
| 13   | 22-14-3714             | A-4455-AA 13 T(P909) | 22-16-3138             | A-4455-AB 13 A(565) | 38-00-1433           | A-4455-CZ13C(P909) |                      |                      |
| 14   | 22-14-3715             | A-4455-AA 14 T(P909) | 22-16-3148             | A-4455-AB 14 A(565) | 38-00-1434           | A-4455-CZ14C(P909) |                      |                      |
| 15   | 22-14-3716             | A-4455-AA 15 T(P909) | 22-16-3158             | A-4455-AB 15 A(565) | 38-00-1435           | A-4455-CZ15C(P909) |                      |                      |
| 16   | 22-14-3717             | A-4455-AA 16 T(P909) | 22-16-3168             | A-4455-AB 16 A(565) | 38-00-1436           | A-4455-CZ16C(P909) |                      |                      |
| 17   | 22-14-3718             | A-4455-AA 17 T(P909) | 22-16-3178             | A-4455-AB 17 A(565) | 38-00-1437           | A-4455-CZ17C(P909) |                      |                      |
| 18   | 22-14-3719             | A-4455-AA 18 T(P909) | 22-16-3188             | A-4455-AB 18 A(565) | 38-00-1438           | A-4455-CZ18C(P909) |                      |                      |
| 19   | 22-14-3811             | A-4455-AA 19 T(P909) | 22-16-3198             | A-4455-AB 19 A(565) | 38-00-1439           | A-4455-CZ19C(P909) |                      |                      |
| 20   | 22-14-3812             | A-4455-AA 20 T(P909) | 22-16-3208             | A-4455-AB 20 A(565) | 38-00-1440           | A-4455-CZ20C(P909) |                      |                      |
| 21   | 22-14-3813             | A-4455-AA 21 T(P909) | 22-16-3218             | A-4455-AB 21 A(565) |                      |                    |                      |                      |
| 22   | 22-14-3814             | A-4455-AA 22 T(P909) | 22-16-3228             | A-4455-AB 22 A(565) |                      |                    |                      |                      |
| 23   | 22-14-3815             | A-4455-AA 23 T(P909) | 22-16-3238             | A-4455-AB 23 A(565) |                      |                    |                      |                      |
| 24   | 22-14-3816             | A-4455-AA 24 T(P909) | 22-16-3248             | A-4455-AB 24 A(565) |                      |                    |                      |                      |
| 25   |                        |                      | 22-16-3258             | A-4455-AB 25 A(565) |                      |                    |                      |                      |

|   |  |                     |  |   |  |                         |  |                                    |        |           |                |              |
|---|--|---------------------|--|---|--|-------------------------|--|------------------------------------|--------|-----------|----------------|--------------|
| THIS DRAWING CONTAINS INFORMATION THAT IS PROPRIETARY TO MOLEX ELECTRONIC TECHNOLOGIES, LLC AND SHOULD NOT BE USED WITHOUT WRITTEN PERMISSION |  |                     |  |   |  |                         |  |                                    |        |           |                |              |
| DIMENSION UNITS<br><b>MM/IN</b>   |  | SCALE<br><b>1:1</b> |  | CURRENT REV DESC: REMOVED OBSOLETE PART NUMBER AS PER PCN#512128. |  |                         |  | molex                              |        |           |                |              |
| GENERAL TOLERANCES (UNLESS SPECIFIED)   |  |                     |  |   |  | EC NO: 716046           |  | KK 100 PCB ASSY<br>4455 SERIES DWG |        |           |                |              |
| 4 PLACES ± 0.25 ± 0.015   |  |                     |  |   |  | DRWN: SANTHN 2022/07/22 |  |                                    |        |           |                |              |
| 3 PLACES ± 0.25 ± 0.015   |  |                     |  |   |  | CHKD: GGA 2022/07/29    |  | PRODUCT CUSTOMER DRAWING           |        |           |                |              |
| 2 PLACES ± 0.25 ± 0.015   |  |                     |  |   |  | APPR: GGA 2022/07/29    |  | DOCUMENT NUMBER                    |        |           |                |              |
| 1 PLACE ± 0.36 ± 0.015  |  |                     |  |   |  | INITIAL REVISION:       |  | SDA-4455                           |        | DOC TYPE  | DOC PART       | REVISION     |
| 0 PLACES ± 0.36 ± 0.015   |  |                     |  |   |  | DRWN: SAMIEC 1984/05/10 |  | PSD                                |        | 001       | D18            |              |
| ANGULAR TOL ± 0.5°  |  |                     |  |   |  | APPR: LENZ 1984/05/10   |  | MATERIAL NUMBER                    |        | CUSTOMER  |                | SHEET NUMBER |
| DRAFT WHERE APPLICABLE MUST REMAIN WITHIN DIMENSIONS  |  |                     |  |   |  | THIRD ANGLE PROJECTION  |  | DRAWING                            | SERIES | SEE CHART | GENERAL MARKET | 13 OF 15     |

# KK 100 PCB ASSY 2-25 CKT 4455 SERIES

| Ckts | Assy Proc: TOP ENTRY |                     | Assy Proc: TOP ENTRY |                      | Assy Proc: BOTTOM ENTRY |                       | Assy Proc: BOTTOM ENTRY |                      |
|------|----------------------|---------------------|----------------------|----------------------|-------------------------|-----------------------|-------------------------|----------------------|
|      | Material No          | Engineer Number     | Material No          | Engineer Number      | Material No             | Engineer Number       | Material No             | Engineer Number      |
| 2    |                      |                     |                      |                      |                         |                       |                         |                      |
| 3    |                      |                     |                      |                      |                         |                       |                         |                      |
| 4    |                      |                     |                      |                      |                         |                       |                         |                      |
| 5    | 50-29-1553           | A-4455-CY 05B(P909) |                      |                      |                         |                       |                         |                      |
| 6    | 50-29-1554           | A-4455-CY 06B(P909) | 22-15-5065           | A-4455-CY06A(P909)-2 |                         |                       |                         |                      |
| 7    |                      |                     |                      |                      |                         |                       |                         |                      |
| 8    |                      |                     |                      |                      |                         |                       |                         |                      |
| 9    |                      |                     |                      |                      |                         |                       |                         |                      |
| 10   |                      |                     |                      |                      |                         |                       |                         |                      |
| 11   |                      |                     |                      |                      | 50-36-1881              | A-4455-BH11D(P909)-10 |                         |                      |
| 12   |                      |                     |                      |                      |                         |                       |                         |                      |
| 13   |                      |                     |                      |                      |                         |                       | 26-01-3099              | A-4455-BH13D(208)-51 |
| 14   |                      |                     |                      |                      |                         |                       |                         |                      |
| 15   |                      |                     |                      |                      |                         |                       |                         |                      |
| 16   |                      |                     |                      |                      |                         |                       |                         |                      |
| 17   |                      |                     |                      |                      |                         |                       |                         |                      |
| 18   |                      |                     |                      |                      |                         |                       |                         |                      |
| 19   |                      |                     |                      |                      |                         |                       |                         |                      |
| 20   |                      |                     |                      |                      |                         |                       |                         |                      |
| 21   |                      |                     |                      |                      |                         |                       |                         |                      |
| 22   |                      |                     |                      |                      |                         |                       |                         |                      |
| 23   |                      |                     |                      |                      |                         |                       |                         |                      |
| 24   |                      |                     |                      |                      |                         |                       |                         |                      |
| 25   |                      |                     |                      |                      |                         |                       |                         |                      |

|   |       |   |         |        |                                    |                |  |  |  |
|---|-------|---|---------|--------|------------------------------------|----------------|--|--|--|
| THIS DRAWING CONTAINS INFORMATION THAT IS PROPRIETARY TO MOLEX ELECTRONIC TECHNOLOGIES, LLC AND SHOULD NOT BE USED WITHOUT WRITTEN PERMISSION |       |   |         |        |                                    |                |  |  |  |
| DIMENSION UNITS   | SCALE | CURRENT REV DESC: REMOVED OBSOLETE PART NUMBER AS PER PCN#512128. |         |        | molex                              |                |  |  |  |
| MM/IN   | 1:1   |   |         |        | KK 100 PCB ASSY<br>4455 SERIES DWG |                |  |  |  |
| GENERAL TOLERANCES (UNLESS SPECIFIED)   |       | EC NO: 716046   |         |        | PRODUCT CUSTOMER DRAWING           |                |  |  |  |
| 4 PLACES ±  | ±     | DRWN: SANTHN 2022/07/22   |         |        | DOCUMENT NUMBER                    |                |  |  |  |
| 3 PLACES ±  | ±     | CHKD: GGA 2022/07/29  |         |        | SDA-4455                           |                |  |  |  |
| 2 PLACES ±  | ±     | APPR: GGA 2022/07/29  |         |        | PSD 001 D18                        |                |  |  |  |
| 1 PLACE ±   | ±     | INITIAL REVISION:   |         |        | SHEET NUMBER                       |                |  |  |  |
| 0 PLACES ±  | ±     | DRWN: SAMIEC 1984/05/10   |         |        | 14 OF 15                           |                |  |  |  |
| ANGULAR TOL ±   | ±     | APPR: LENZ 1984/05/10   |         |        |                                    |                |  |  |  |
| DRAFT WHERE APPLICABLE MUST REMAIN WITHIN DIMENSIONS  |       | THIRD ANGLE PROJECTION  | DRAWING | SERIES | MATERIAL NUMBER                    | CUSTOMER       |  |  |  |
|   |       |   | B-SIZE  | 4455   | SEE CHART                          | GENERAL MARKET |  |  |  |

# KK 100 PCB ASSY 2-25 CKT 4455 SERIES

| Ckts | Material No | Engineer Number       | Material No | Engineer Number    | Material No | Engineer Number     | Material No | Engineer Number     |
|------|-------------|-----------------------|-------------|--------------------|-------------|---------------------|-------------|---------------------|
| 2    |             |                       |             |                    |             |                     |             |                     |
| 3    |             |                       | 46999-0585  | A-4455-CG03A(P909) |             |                     | 22-02-2031  | A-4455-CY 03A(P909) |
| 4    |             |                       | 46999-0583  | A-4455-CG04A(P909) |             |                     |             |                     |
| 5    |             |                       |             |                    |             |                     |             |                     |
| 6    |             |                       | 46999-0584  | A-4455-CG06A(P909) |             |                     |             |                     |
| 7    |             |                       |             |                    |             |                     |             |                     |
| 8    |             |                       |             |                    | 46999-0599  | A-4455-CP 08A(P909) |             |                     |
| 9    |             |                       |             |                    |             |                     |             |                     |
| 10   |             |                       |             |                    |             |                     |             |                     |
| 11   |             |                       |             |                    |             |                     |             |                     |
| 12   |             |                       |             |                    |             |                     |             |                     |
| 13   |             |                       |             |                    |             |                     |             |                     |
| 14   |             |                       | 46999-0586  | A-4455-CG14A(P909) |             |                     |             |                     |
| 15   |             |                       |             |                    |             |                     |             |                     |
| 16   |             |                       |             |                    |             |                     |             |                     |
| 17   | 46999-0582  | A-4455-AB17A(P909)-51 |             |                    |             |                     |             |                     |
| 18   |             |                       |             |                    |             |                     |             |                     |
| 19   |             |                       |             |                    |             |                     |             |                     |
| 20   |             |                       |             |                    |             |                     |             |                     |
| 21   |             |                       |             |                    |             |                     |             |                     |
| 22   |             |                       |             |                    |             |                     |             |                     |
| 23   |             |                       |             |                    |             |                     |             |                     |
| 24   |             |                       |             |                    |             |                     |             |                     |
| 25   |             |                       |             |                    |             |                     |             |                     |

|   |                |   |  |  |  |  |  |  |  |
|---|----------------|---|--|--|--|--|--|--|--|
| THIS DRAWING CONTAINS INFORMATION THAT IS PROPRIETARY TO MOLEX ELECTRONIC TECHNOLOGIES, LLC AND SHOULD NOT BE USED WITHOUT WRITTEN PERMISSION |                |   |  |  |  |  |  |  |  |
| DIMENSION UNITS   | SCALE          | CURRENT REV DESC: REMOVED OBSOLETE PART NUMBER AS PER PCN#512128. |  |  | molex  |  |  |  |  |
| MM/IN   | 1:1            |   |  |  |  |  |  |  |  |
| GENERAL TOLERANCES (UNLESS SPECIFIED)   |                | EC NO: 716046<br>DRWN: SANTHN<br>CHKD: GGA<br>APPR: GGA           |  |  | 2022/07/22<br>2022/07/29<br>2022/07/29               |  |  |  |  |
| 4 PLACES  | ± 0.25 ± 0.015 |   |  |  |  |  |  |  |  |
| 3 PLACES  | ± 0.25 ± 0.015 | INITIAL REVISION:<br>DRWN: SAMIEC<br>APPR: LENZ                   |  |  | 1984/05/10<br>1984/05/10                             |  |  |  |  |
| 2 PLACES  | ± 0.25 ± 0.015 |   |  |  |  |  |  |  |  |
| 1 PLACE   | ± 0.36 ± 0.015 | THIRD ANGLE PROJECTION  |  |  | DRAWING SERIES MATERIAL NUMBER CUSTOMER SHEET NUMBER |  |  |  |  |
| 0 PLACES  | ± 0.36 ± 0.015 |   |  |  |  |  |  |  |  |
| ANGULAR TOL ± 0.5°  |                |   |  |  | B-SIZE 4455 SEE CHART GENERAL MARKET 15 OF 15        |  |  |  |  |

|                          |          |          |          |
|--------------------------|----------|----------|----------|
| PRODUCT CUSTOMER DRAWING |          |          |          |
| DOCUMENT NUMBER          | DOC TYPE | DOC PART | REVISION |
| SDA-4455                 | PSD      | 001      | D18      |