

CDBV3-70/S/C/A-G

Reverse Voltage: 70 Volts

Forward Current: 70 mA

RoHS Device

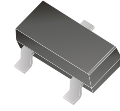

Features

- Design for mounting on small surface.
- High speed switching application, circuit protection.
- Low turn-on voltage.
- High breakdown voltage.
- Guard ring protected.

Mechanical data

- Case: SOT-323, molded plastic.
- Terminals: Solder plated, solderable per MIL-STD-750, method 2026.
- Weight: 0.006 grams(approx.).

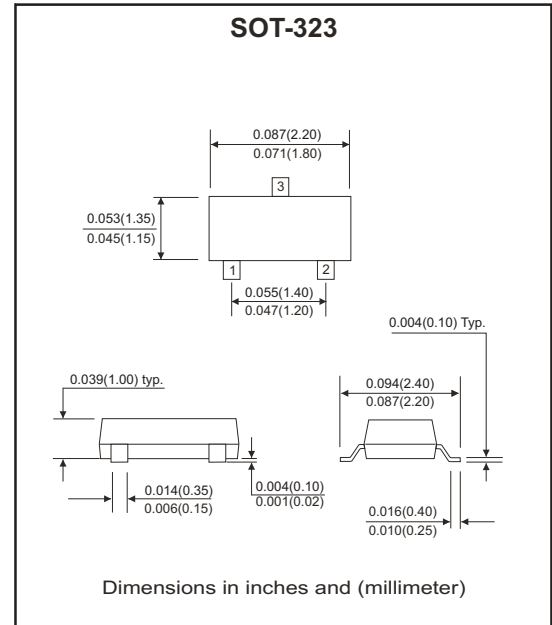

Circuit diagram

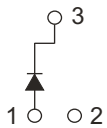

CDBV3-70-G
Marking : K73

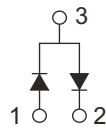

CDBV3-70S-G
Marking : K74

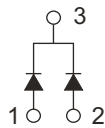

CDBV3-70C-G
Marking : K75

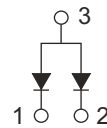

CDBV3-70A-G
Marking : K76

Maximum Ratings (at Ta=25°C unless otherwise noted)

Parameter	Symbol	Value	Unit
Peak repetitive peak reverse voltage Reverse voltage	V_{RRM} V_R	70	V
RMS reverse voltage	$V_{R(RMS)}$	50	V
Forward current	I_F	70	mA
Non-Repetitive peak forward surge current @t=1μs	I_{FS}	100	mA
Power dissipation	P_D	200	mW
Junction temperature range	T_J	-40~150	°C
Storage temperature range	T_{STG}	-65 to +150	°C

Electrical Characteristics (at $T_a=25^\circ\text{C}$ unless otherwise noted)

Parameter	Symbol	Conditions	Min.	Max.	Unit
Reverse breakdown voltage	$V_{(BR)R}$	$I_R=10\mu\text{A}$	70		V
Reverse voltage leakage current	I_R	$V_R=50\text{V}$		100	nA
Forward voltage	V_F	$I_F=1\text{mA}$ $I_F=15\text{mA}$		410 1000	mV
Diode capacitance	C_D	$V_R=0\text{V}, f=1\text{MHz}$		2	pF
Reverse recovery time	T_{rr}	$I_F=I_R=10\text{mA}, R_L=100\Omega$		5	nS

RATING AND CHARACTERISTIC CURVES (CDBV3-70/S/C/A-G)

Fig.1 - Forward Characteristics

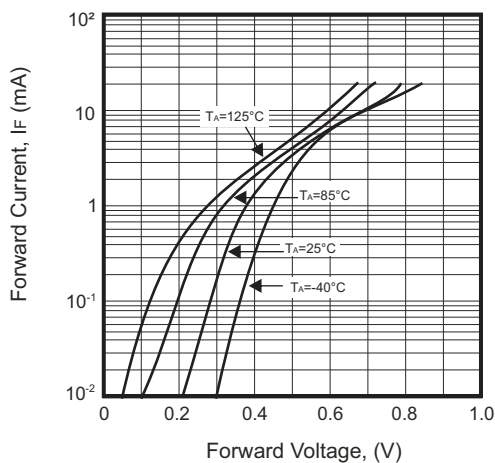

Fig.2 - Leakage Current

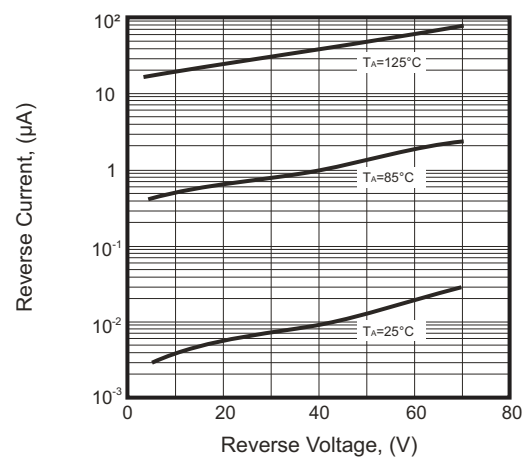

Fig.4 - Power Derating Curve

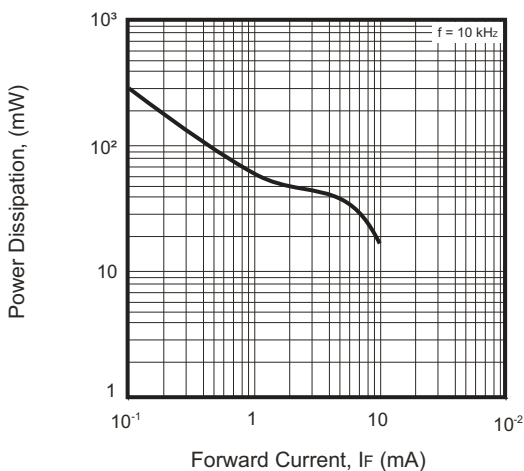
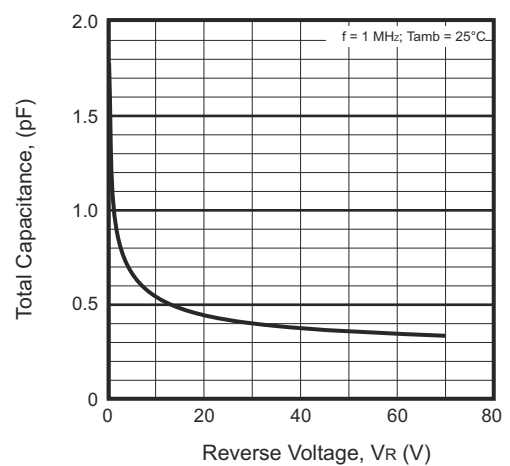
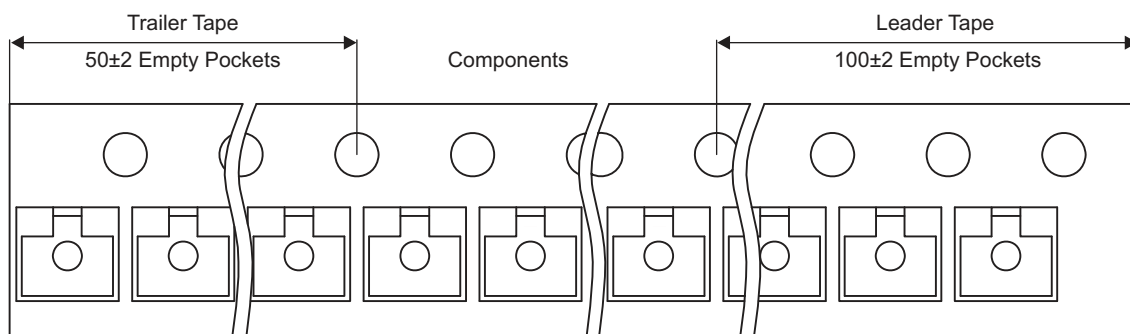
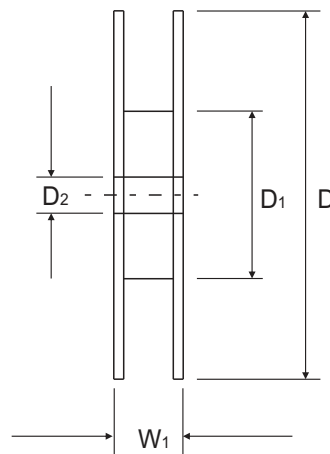
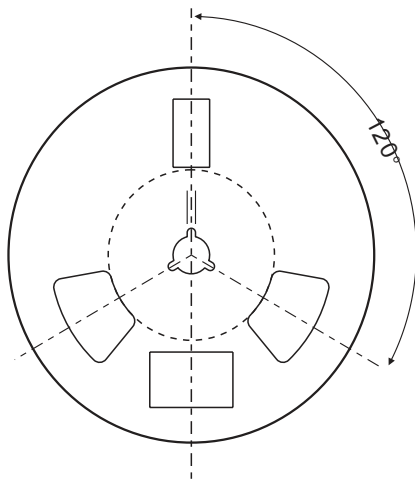
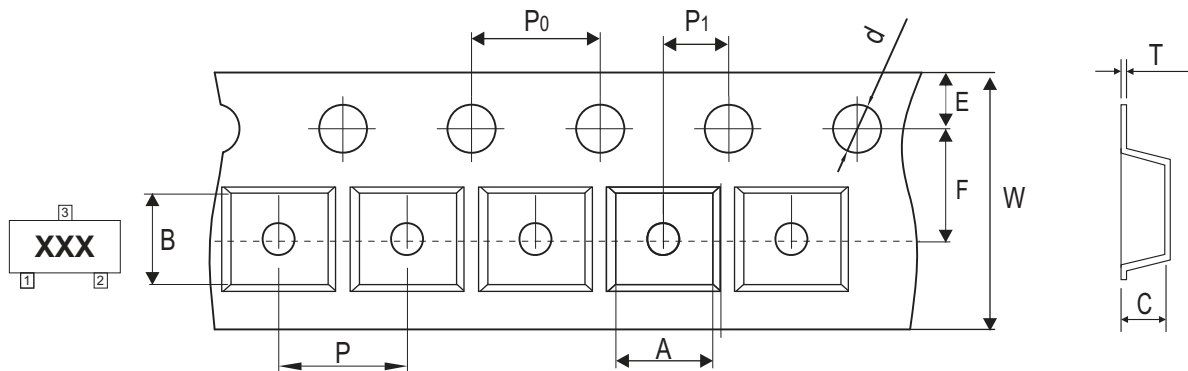

Fig.3 - Total Capacitance



Reel Taping Specification



SOT-323	SYMBOL	A	B	C	d	D	D ₁	D ₂
	(mm)	2.40 ± 0.10	2.50 ± 0.10	1.15 ± 0.10	1.50 ± 0.10	178 ± 1.00	54.00 ± 0.50	13.00 ± 0.50
	(inch)	0.094 ± 0.004	0.098 ± 0.004	0.045 ± 0.004	0.059 ± 0.004	7.008 ± 0.039	2.126 ± 0.020	0.512 ± 0.020

SOT-323	SYMBOL	E	F	P	P ₀	P ₁	W	W ₁
	(mm)	1.75 ± 0.10	3.50 ± 0.05	4.00 ± 0.10	4.00 ± 0.10	2.00 ± 0.05	8.00 + 0.30 - 0.10	12.00 ± 1.0
	(inch)	0.069 ± 0.004	0.138 ± 0.002	0.157 ± 0.004	0.157 ± 0.004	0.079 ± 0.002	0.315 + 0.012 - 0.004	0.472 ± 0.039

Company reserves the right to improve product design, functions and reliability without notice.

Marking Code

Part Number	Marking Code
CDBV3-70-G	K73
CDBV3-70S-G	K74
CDBV3-70C-G	K75
CDBV3-70A-G	K76

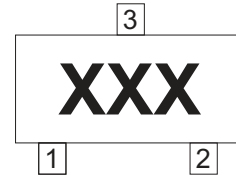

xxx = Product type marking code

Suggested PAD Layout

SIZE	SOT-323	
	(mm)	(inch)
A	0.70	0.028
B	0.90	0.035
C	0.65	0.026
D	1.90	0.075
E	2.80	0.110

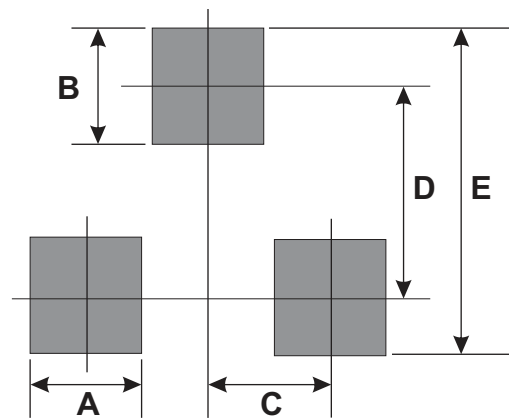

Standard Packaging

Case Type	REEL PACK	
	REEL (pcs)	Reel Size (inch)
SOT-323	3,000	7