







T1/E1/CEPT/ISDN-PRI INTERFACE MODULES



Dual Surface Mount Transformer Modules, 1500 Vrms, Extended Temperature Range



-  RoHS peak reflow temperature rating 245°C
-  Optimized for enhanced EMC performance
-  Extended temperature range
-  Dual SMT package contains transformers with common mode chokes on both transmit and receive channels
-  Models matched to leading transceiver ICs
-  Patented Interlock Base construction for high reliability
-  UL1950 approved

Electrical Specifications @ 25°C

RoHS Compliant Part Number	Turns Ratio ² (Pri:Sec ± 2%)	Secondary OCL @ 25°C (mH MIN)	LL (µH MAX)	Cw/w (pF MAX)	DCR Pri (Ω MAX)	Package/ Schematic	Primary Pins
EXTENDED TEMPERATURE RANGE MODELS¹ – OPERATING TEMPERATURE -40°C TO +85°C							
T1212NL	1CT:1CT & 1CT:2CT	1.20	.60	35	.90	AN/1	1-3, 4-6
T1215NL	1CT:1.41CT & 1CT:1.41CT	1.20	.60	30	.70	AN/1	1-3, 4-6
T1217NL	1CT:2.42CT & 1CT:2.42CT	1.20	.60	25	.60	AN/1	1-3, 4-6
T1219NL	1CT:2.4CT & 1CT:1CT	1.20	.60	35	.90	AN/1	1-3, 4-6

- Extended Temperature Range Models** — For extended temperature range transformers (-40°C to +85°C operating temperature range), OCL (Open Circuit Inductance) is specified at both -40°C and +25°C. At -40°C, OCL is 600 µH minimum. All other parameters are specified at +25°C only. Standard temperature range is 0°C to +70°C.
- Turns ratio** is specified primary:secondary (CT = Center Tap).
- Standard packaging** for the surface mount package is anti-static tubes. Optional Tape & Reel packaging can be ordered by adding a “T” suffix to the part number, (i.e. T1212NLT).

Mechanical

Schematic

AN

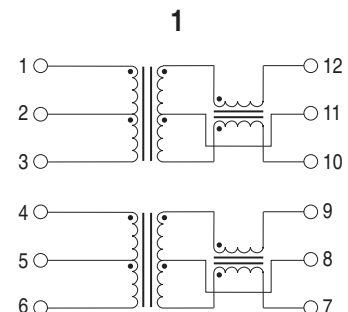
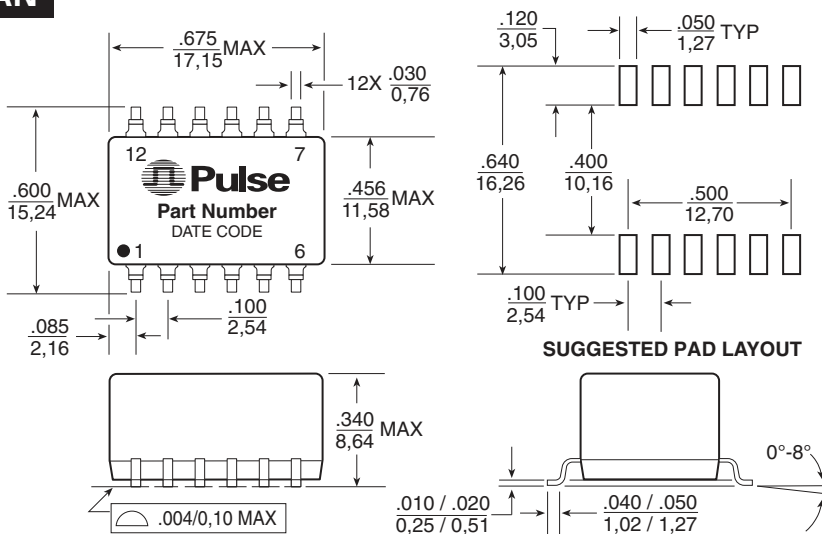

Dimensions: $\frac{\text{Inches.}}{\text{mm}}$ Unless otherwise specified, all tolerances are $\pm \frac{.010}{0,25}$

Weight 4.0 grams
Tape & Reel 250/reel
Tube 30/tube

T1/E1/CEPT/ISDN-PRI INTERFACE MODULES

Dual Surface Mount Transformer Modules, 1500 Vrms, Extended Temperature Range



Application Notes

1. **ET Product** — All coils have an ET product of 10 V-µsec minimum.
2. **Flammability** — Materials used in these products are recognized as UL94-VO approved. Products meet the requirements of IEC 695-2-2 (Needle Flame Test).
3. **Balance Characteristics** — The transformers meet the requirements for longitudinal balance of FCC part 68.
4. **Common Mode Rejection Ratio** — the CMRR for all transformers is better than 50 dB at 1 MHz.
5. **Crosstalk Attenuation** — In the packages which contain transmit and receive transformers side by side, sufficient crosstalk attenuation is achieved by the inherent characteristics of the toroid cores as well as by their proper positioning. The crosstalk attenuation is typically 65 dB or better.
6. **Return Loss** — ITU-T G.703 and the European national regulatory documents specify minimum return loss levels. The transformers will allow these limits to be complied within the situations where they are applicable.
7. **Surge Voltage Capability** — All transformers and chokes meet surge voltage tests according to the most stringent regulatory documents, when used with the proper voltage and current suppression devices:
 - Metallic Voltage: 800 V peak, 10/560 µsec
 - Longitudinal Voltage: 2,400 V peak, 10/700 µsec
8. **Isolation Voltage** — 100% of transformers are tested during production to the specified isolation voltage level.
9. **General Information** — The transformers are specifically designed for use in 1.544 Mbps (T1), 2.048 Mbps (CEPT) and ISDN Primary Rate Interface (PRI) applications. They are matched to the majority of the line interface transceiver ICs currently available. Use of the proper transformer allows the interface circuit to comply with ITU-T G.703 and other standards regarding pulse waveform, return loss, and balance.
10. **Transformer Selection Guide** — Please contact Pulse Application Engineering or see our website for the latest Pulse Transformer Selection Guide.

Frequency	50-100 KHz	100 KHz-2 MHz	2-3 MHz
Return Loss			
XMIT	9 dB	15 dB	11 dB
RCV	12 dB	18 dB	14 dB

For More Information:

Pulse Worldwide Headquarters

12220 World Trade Dr.
San Diego, CA 92128
U.S.A.

www.pulseeng.com

Tel: 858 674 8100
Fax: 858 674 8262

Pulse Europe

Einsteinstrasse 1
D-71083 Herrenberg
Germany

Tel: 49 7032 7806 0
Fax: 49 7032 7806 135

Pulse China Headquarters

B402, Shenzhen Academy of
Aerospace Technology Bldg.
10th Kejinan Rd.
High-Tech Zone
Nanshan District
Shenzhen, PR China 518057

Tel: 86 755 33966678
Fax: 86 755 33966700

Pulse North China

Room 2704/2705
Super Ocean Finance Ctr.
2067 Yan An Rd. West
Shanghai 200336
China

Tel: 86 21 62787060
Fax: 86 2162786973

Pulse South Asia

135 Joo Seng Rd.
#03-02
PM Industrial Bldg.
Singapore 368363

Tel: 65 6287 8998
Fax: 65 6287 8998

Pulse North Asia

3F, No. 198
Zhongyuan Rd.
Zhongli City
Taoyuan County 320
Taiwan R. O. C.

Tel: 886 3 4356768
Fax: FRE 886 3 4356820
Pulse: 886 3 4356823

Performance warranty of products offered on this data sheet is limited to the parameters specified. Data is subject to change without notice. Other brand and product names mentioned herein may be trademarks or registered trademarks of their respective owners.

© Copyright, 2009. Pulse Engineering, Inc. All rights reserved.