

## 2-line ESD protection for high speed lines

Datasheet - production data

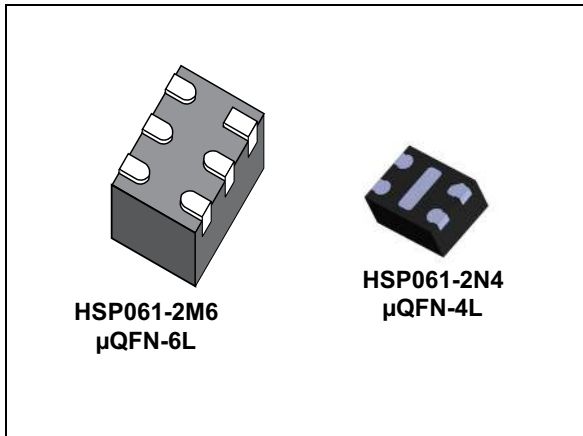
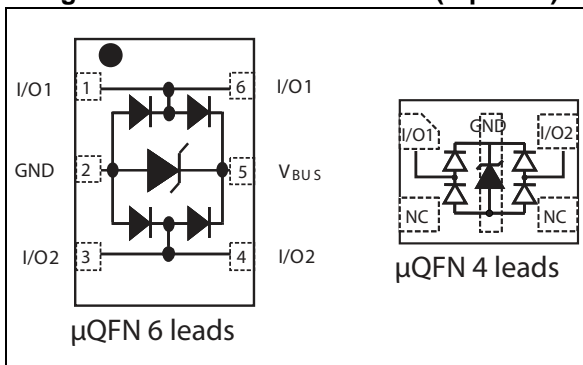

Figure 1. Functional schematic (top view)



### Features

- Flow-through routing to keep signal integrity
- Ultralarge bandwidth: 6 GHz
- Ultralow capacitance: 0.6 pF
- Low leakage current: 100 nA at 25 °C
- Extended operating junction temperature range: -40 °C to 150 °C
- RoHS compliant

### Benefits

- High ESD robustness of the equipment
- Suitable for high density boards

### Complies with following standards

- MIL-STD 883G Method 3015-7 Class 3B:
  - 8 kV
- IEC 61000-4-2 level 4:
  - 15 kV (air discharge)
  - 8 kV (contact discharge)

### Applications

The HSP061-2 series is designed to protect against electrostatic discharge on sub micron technology circuits driving:

- HDMI 1.3 and 1.4
- Digital Video Interface
- Display Port
- USB 3.0
- Serial ATA
- Ethernet
- HMI

### Description

The HSP061-2 is a 2-channel ESD array with a rail-to-rail architecture designed specifically for the protection of high speed differential lines.

The ultralow variation of the capacitance ensures very low influence on signal-skew. The large bandwidth makes it compatible with 5 Gbps.

The HSP061-2M6 is packaged in μQFN-6L (1.45 x 1.0 mm) with a 500 μm pitch. The HSP061-2N4 is packaged in μQFN-4L (1.0 x 0.8 mm) with a 400 μm pitch.

# 1 Characteristics

**Table 1. Absolute maximum ratings  $T_{amb} = 25\text{ }^{\circ}\text{C}$**

| Symbol    | Parameter   |                                 | Value       | Unit               |
|-----------|---|---------------------------------|-------------|--------------------|
| $V_{PP}$  | Peak pulse voltage                                  | IEC 61000-4-2 contact discharge | 8           | kV                 |
|           |   | IEC 61000-4-2 air discharge     | 15          |                    |
| $I_{pp}$  | Repetitive peak pulse current (8/20 $\mu\text{s}$ ) |                                 | 3           | A                  |
| $T_j$     | Operating junction temperature range                |                                 | -40 to +150 | $^{\circ}\text{C}$ |
| $T_{stg}$ | Storage temperature range                           |                                 | -65 to +150 | $^{\circ}\text{C}$ |
| $T_L$     | Maximum lead temperature for soldering during 10 s  |                                 | 260         | $^{\circ}\text{C}$ |

**Table 2. Electrical characteristics  $T_{amb} = 25\text{ }^{\circ}\text{C}$**

| Symbol                 | Parameter                                      | Test conditions   | Min.       | Typ. | Max. | Unit |
|------------------------|--|---|------------|------|------|------|
| $V_{BR}$               | Breakdown voltage                              | $I_R = 1\text{ mA}$   | 6          |      |      | V    |
| $I_{RM}$               | Leakage current                                | $V_{RM} = 3\text{ V}$   |            |      | 100  | nA   |
| $V_{CL}$               | Clamping voltage                               | IEC 61000-4-2, +8 kV contact ( $I_{PP} = 30\text{ A}$ ), measured at 30 ns              |            | 18   |      | V    |
| $C_{I/O - GND}$        | Capacitance (input/output to ground)           | $V_{I/O} = 0\text{ V}$ , $F = 200\text{ to }3000\text{ MHz}$ , $V_{OSC} = 30\text{ mV}$ |            | 0.6  | 0.85 | pF   |
| $\Delta C_{I/O - GND}$ | Capacitance variation (input/output to ground) | $V_{I/O} = 0\text{ V}$ , $F = 200\text{ to }3000\text{ MHz}$ , $V_{OSC} = 30\text{ mV}$ |            | 0.03 | 0.13 | pF   |
| $f_C$                  | Cut-off frequency                              | -3 dB   | HSP061-2M6 | 5.5  |      | GHz  |
|                        |  |   | HSP061-2N4 | 6    |      |      |

Figure 2. Leakage current versus junction temperature (typical values)

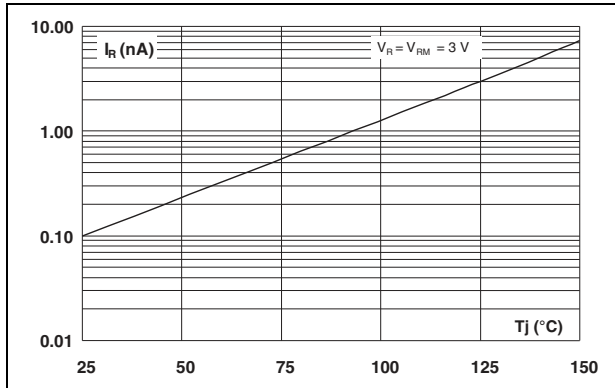

Figure 3. S21 attenuation measurement (HSP061-2M6)

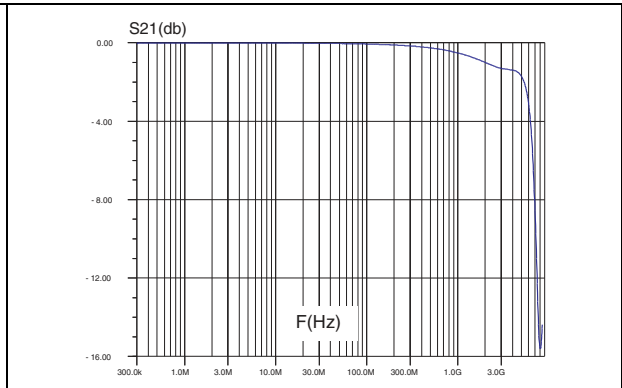

Figure 4. S21 attenuation measurement (HSP061-2N4)

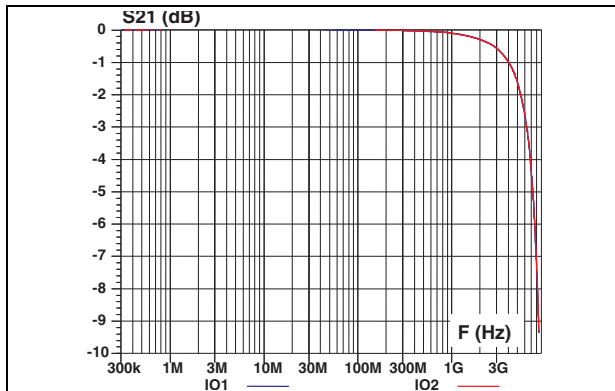
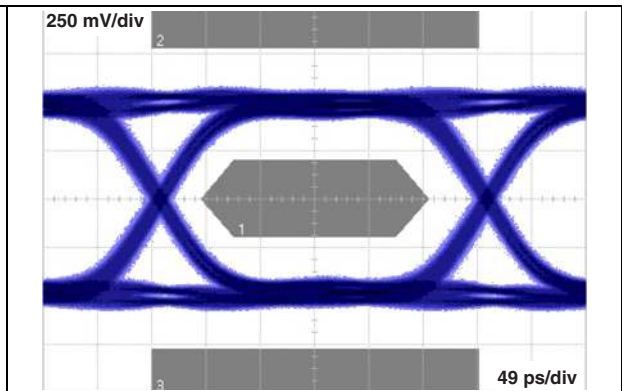

Figure 5. Eye diagram - HDMI mask at 3.4 Gbps per channel<sup>(1)</sup> (HSP061-2M6)



1. HDMI specification conditions. This information can be provided for other applications. Please contact your local ST office.

Figure 6. Eye diagram - HDMI mask at 3.4 Gbps per channel<sup>(1)</sup> (HSP061-2N4)

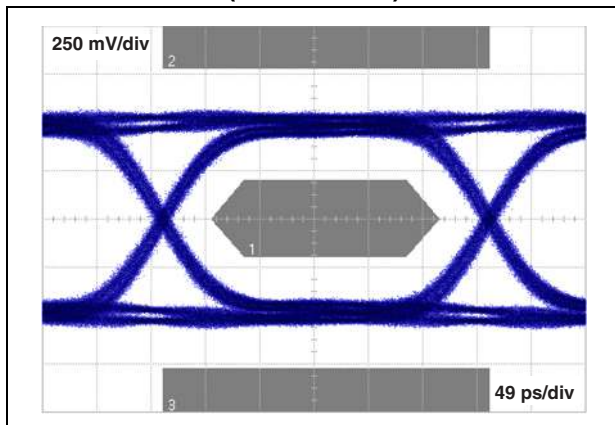

Figure 7. ESD response to IEC 61000-4-2 (+8 kV contact discharge)

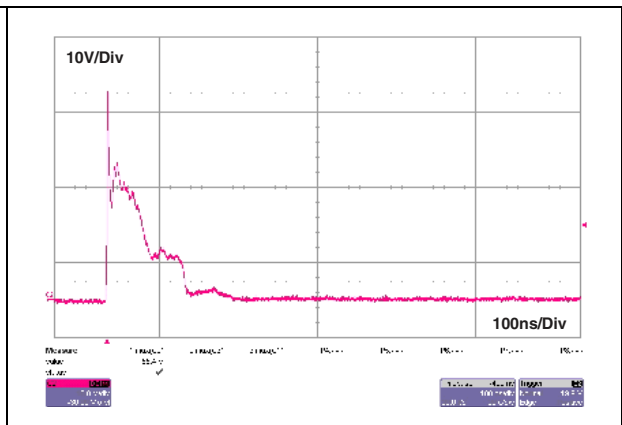
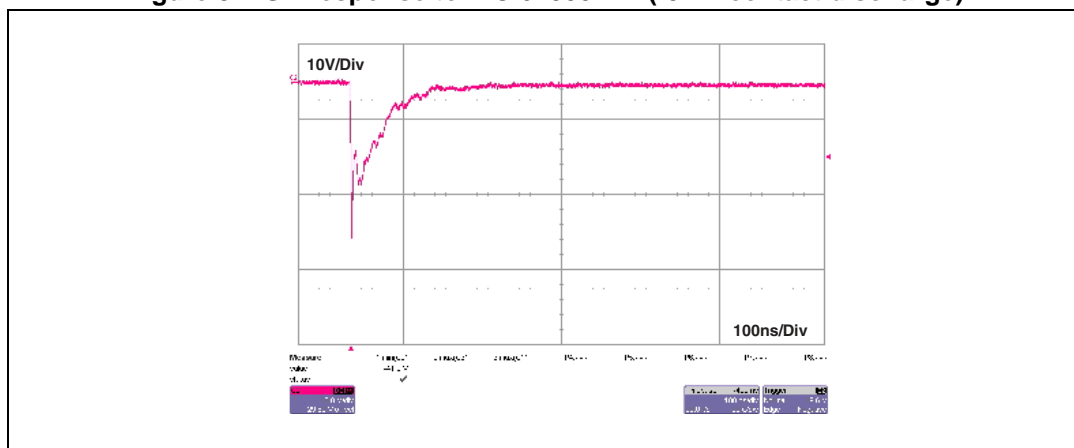

Figure 8. ESD response to IEC 61000-4-2 (-8 kV contact discharge)



## 2 Package information

- Epoxy meets UL94, V0
- Lead-free package

In order to meet environmental requirements, ST offers these devices in different grades of ECOPACK<sup>®</sup> packages, depending on their level of environmental compliance. ECOPACK<sup>®</sup> specifications, grade definitions and product status are available at: [www.st.com](http://www.st.com). ECOPACK<sup>®</sup> is an ST trademark.

## 2.1 $\mu$ QFN 1.45x1.00 6L package information

Table 3.  $\mu$ QFN 1.45x1.00 6L dimensions

| Ref. | Dimensions  |      |      |        |       |       |
|------|-------------|------|------|--------|-------|-------|
|      | Millimeters |      |      | Inches |       |       |
|      | Min.        | Typ. | Max. | Min.   | Typ.  | Max.  |
| A    | 0.50        | 0.55 | 0.60 | 0.020  | 0.022 | 0.024 |
| A1   | 0.00        | 0.02 | 0.05 | 0.000  | 0.001 | 0.002 |
| b    | 0.18        | 0.25 | 0.30 | 0.007  | 0.010 | 0.012 |
| D    |             | 1.45 |      |        | 0.057 |       |
| E    |             | 1.00 |      |        | 0.039 |       |
| e    |             | 0.50 |      |        | 0.020 |       |
| K    | 0.20        |      |      | 0.008  |       |       |
| L    | 0.30        | 0.35 | 0.40 | 0.012  | 0.014 | 0.016 |

Figure 9. Footprint recommendations dimensions in mm (inches)

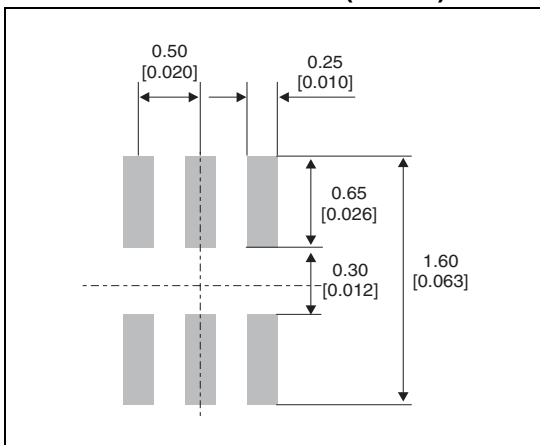
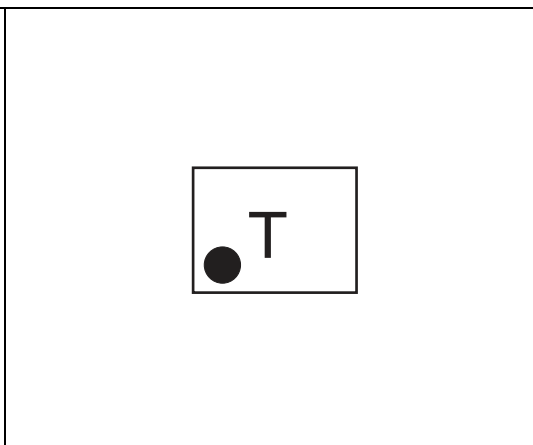

Figure 10. Marking for  $\mu$ QFN 1.45x1.00 6L



*Note:* Product marking may be rotated by 90° for assembly plant differentiation. In no case should this product marking be used to orient the component for its placement on a PCB. Only pin 1 mark is to be used for this purpose.

## 2.2 $\mu$ QFN-4L package information

Table 4.  $\mu$ QFN-4L dimensions

| Ref. | Dimensions  |      |      |        |       |       |
|------|-------------|------|------|--------|-------|-------|
|      | Millimeters |      |      | Inches |       |       |
|      | Min.        | Typ. | Max. | Min.   | Typ.  | Max.  |
| A    | 0.45        | 0.50 | 0.55 | 0.018  | 0.020 | 0.022 |
| A1   | 0.00        | 0.02 | 0.05 | 0.000  | 0.001 | 0.002 |
| b    | 0.15        | 0.20 | 0.25 | 0.006  | 0.008 | 0.010 |
| D    | 0.75        | 0.80 | 0.85 | 0.030  | 0.031 | 0.033 |
| D2   | 0.55        | 0.6  | 0.65 | 0.022  | 0.024 | 0.026 |
| e    | 0.35        | 0.40 | 0.45 | 0.014  | 0.016 | 0.018 |
| E    | 0.95        | 1.00 | 1.05 | 0.037  | 0.039 | 0.041 |
| E2   | 0.15        | 0.20 | 0.25 | 0.006  | 0.008 | 0.010 |
| k    | 0.17        | 0.20 | 0.23 | 0.007  | 0.008 | 0.009 |
| L    | 0.15        | 0.20 | 0.25 | 0.006  | 0.008 | 0.010 |

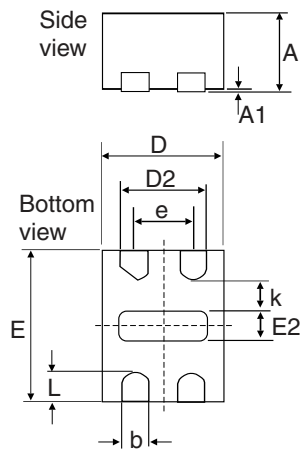
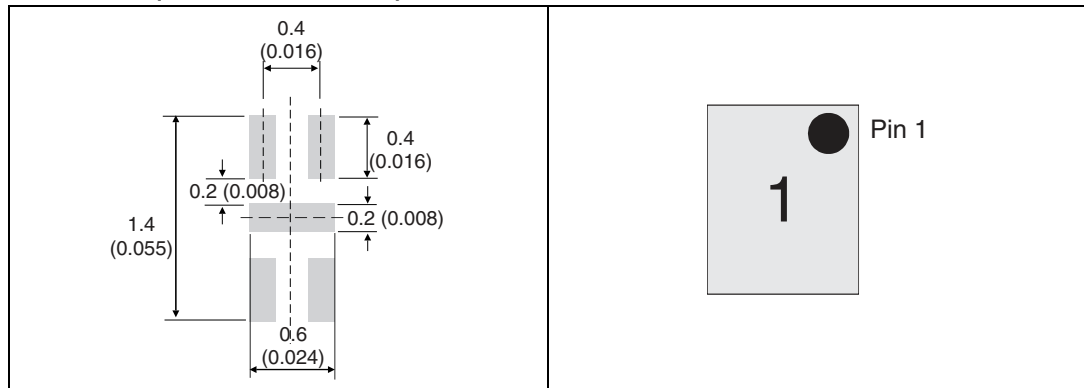

Figure 11. Footprint recommendations (dimensions in mm)

Figure 12. Marking for  $\mu$ QFN-4L



**Note:** Product marking may be rotated by 90° for assembly plant differentiation. In no case should this product marking be used to orient the component for its placement on a PCB. Only pin 1 mark is to be used for this purpose.

### 3 Recommendation on PCB assembly

#### 3.1 Stencil opening design

1. General recommendation on stencil opening design
  - a) Stencil opening dimensions: L (Length), W (Width), T (Thickness).

Figure 13. Stencil opening dimensions

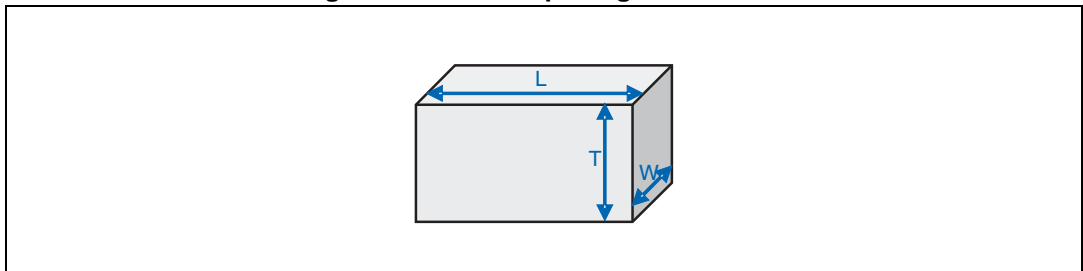

- b) General design rule
  - Stencil thickness (T) = 75 ~ 125 μm
  - Aspect Ratio =  $\frac{W}{T} \geq 1.5$
  - Aspect Area =  $\frac{L \times W}{2T(L + W)} \geq 0.66$

2. Reference design
  - a) Stencil opening thickness: 100 μm
  - b) Stencil opening for leads: Opening to footprint ratio is 90%.

Figure 14. Recommended stencil window position for μQFN-6L

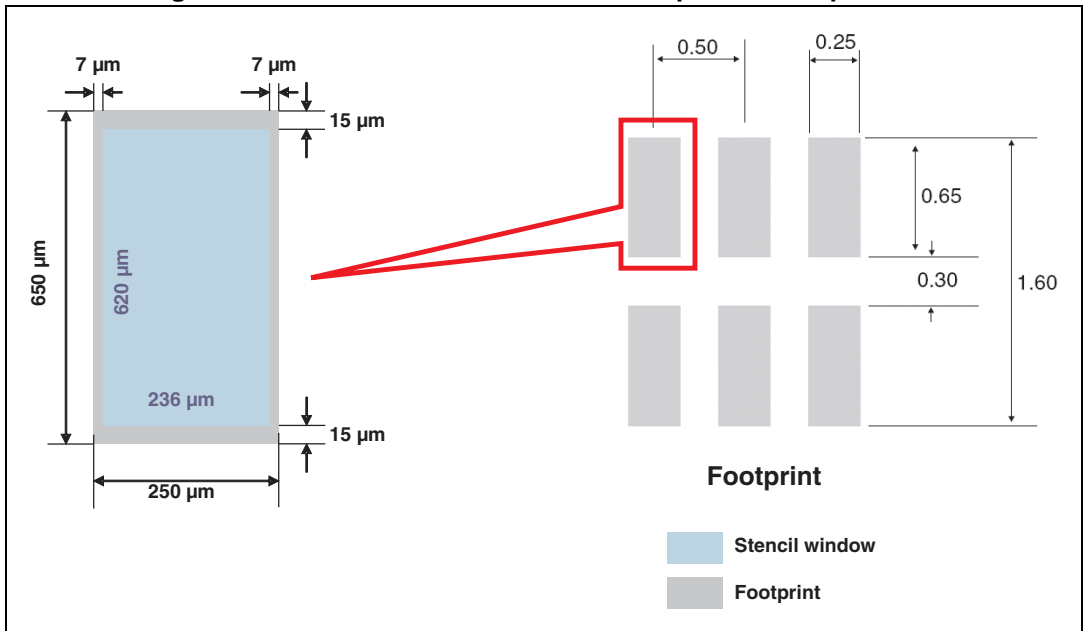
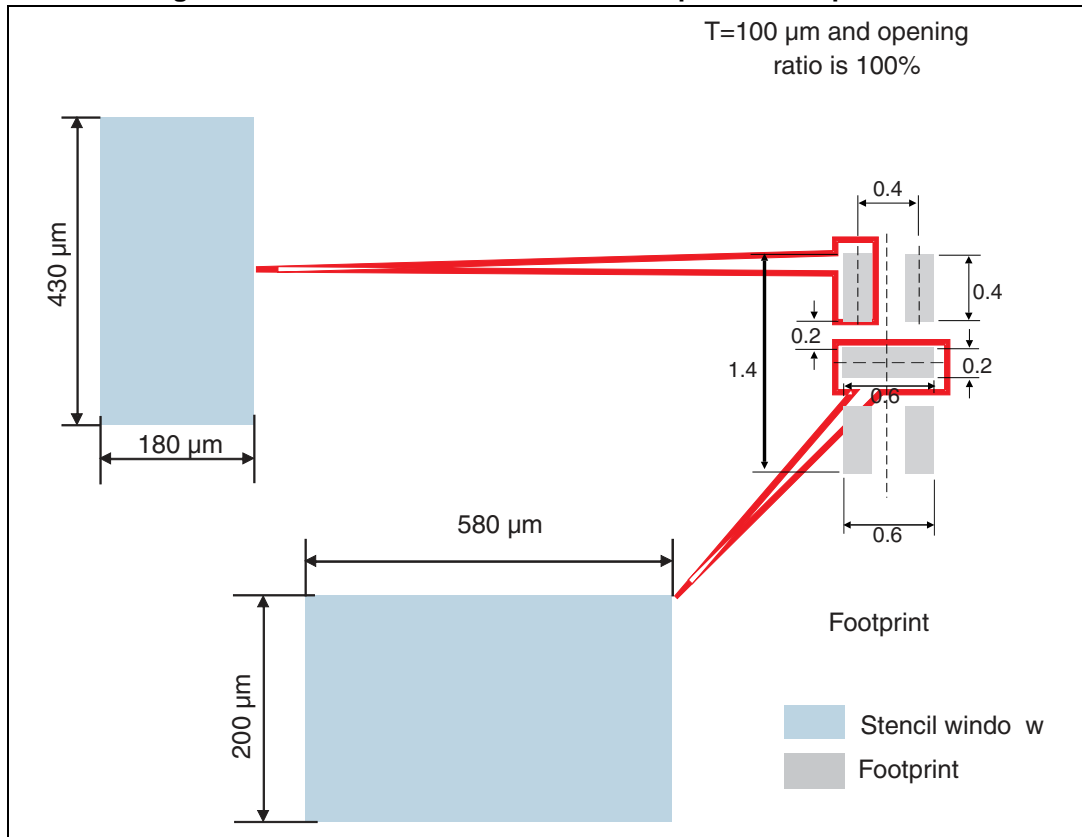



Figure 15. Recommended stencil window position for  $\mu$ QFN-4L

### 3.2 Solder paste

1. Halide-free flux qualification ROL0 according to ANSI/J-STD-004.
2. "No clean" solder paste is recommended.
3. Offers a high tack force to resist component movement during high speed.
4. Solder paste with fine particles: powder particle size is 20-45  $\mu$ m.

### 3.3 Placement

1. Manual positioning is not recommended.
2. It is recommended to use the lead recognition capabilities of the placement system, not the outline centering.
3. Standard tolerance of  $\pm 0.05$  mm is recommended.
4. 3.5 N placement force is recommended. Too much placement force can lead to squeezed out solder paste and cause solder joints to short. Too low placement force

can lead to insufficient contact between package and solder paste that could cause open solder joints or badly centered packages.

5. To improve the package placement accuracy, a bottom side optical control should be performed with a high resolution tool.
6. For assembly, a perfect supporting of the PCB (all the more on flexible PCB) is recommended during solder paste printing, pick and place and reflow soldering by using optimized tools.

### 3.4 PCB design preference

1. To control the solder paste amount, the closed via is recommended instead of open vias.
2. The position of tracks and open vias in the solder area should be well balanced. The symmetrical layout is recommended, in case any tilt phenomena caused by asymmetrical solder paste amount due to the solder flow away.

### 3.5 Reflow profile

Figure 16. ST ECOPACK® recommended soldering reflow profile for PCB mounting

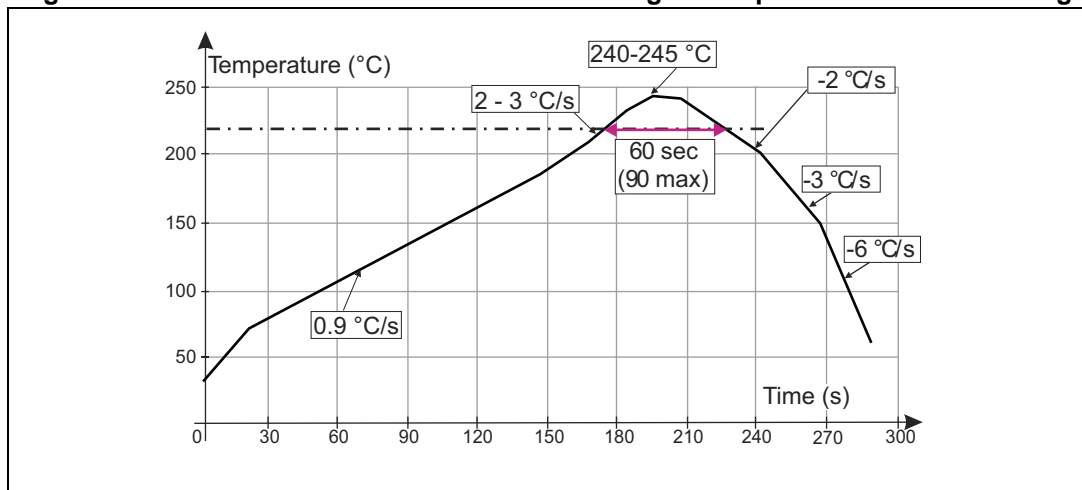

Note: Minimize air convection currents in the reflow oven to avoid component movement. Maximum soldering profile corresponds to the latest IPC/JEDEC J-STD-020.

## 4 Ordering information

Figure 17. Ordering information scheme

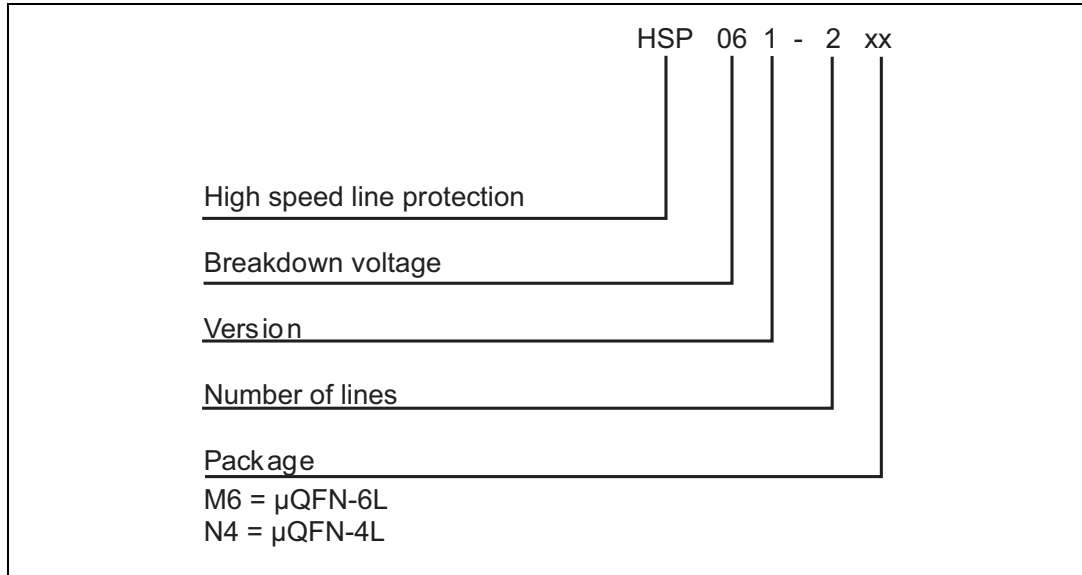

Table 5. Ordering information

| Order code | Marking          | Package | Weight  | Base qty | Delivery mode      |
|------------|------------------|---------|---------|----------|--------------------|
| HSP061-2M6 | T <sup>(1)</sup> | μQFN-6L | 2.3 mg  | 3000     | Tape and reel (7") |
| HSP061-2N4 | 1 <sup>(1)</sup> | μQFN-4L | 1.17 mg | 10000    | Tape and reel (7") |

1. The marking can be rotated by multiple of 90° to differentiate assembly location

## 5 Revision history

Table 6. Document revision history

| Date        | Revision | Changes   |
|-------------|----------|---|
| 07-Feb-2012 | 1        | Initial release.  |
| 19-Mar-2014 | 2        | Minor text changes.   |
| 13-Oct-2015 | 3        | Removed device in SOT-666.<br>Updated document accordingly. |

**IMPORTANT NOTICE – PLEASE READ CAREFULLY**

STMicroelectronics NV and its subsidiaries ("ST") reserve the right to make changes, corrections, enhancements, modifications, and improvements to ST products and/or to this document at any time without notice. Purchasers should obtain the latest relevant information on ST products before placing orders. ST products are sold pursuant to ST's terms and conditions of sale in place at the time of order acknowledgement.

Purchasers are solely responsible for the choice, selection, and use of ST products and ST assumes no liability for application assistance or the design of Purchasers' products.

No license, express or implied, to any intellectual property right is granted by ST herein.

Resale of ST products with provisions different from the information set forth herein shall void any warranty granted by ST for such product.

ST and the ST logo are trademarks of ST. All other product or service names are the property of their respective owners.

Information in this document supersedes and replaces information previously supplied in any prior versions of this document.

© 2015 STMicroelectronics – All rights reserved