

## STRADELLA-T2

IESNA Type II (medium) beam applicable for European P-class standard pedestrian lighting and M-class roads

### SPECIFICATION:

Dimensions	13.9 x 13.9 mm
Height	5 mm
Fastening	glue, pin
ROHS compliant	yes ⓘ

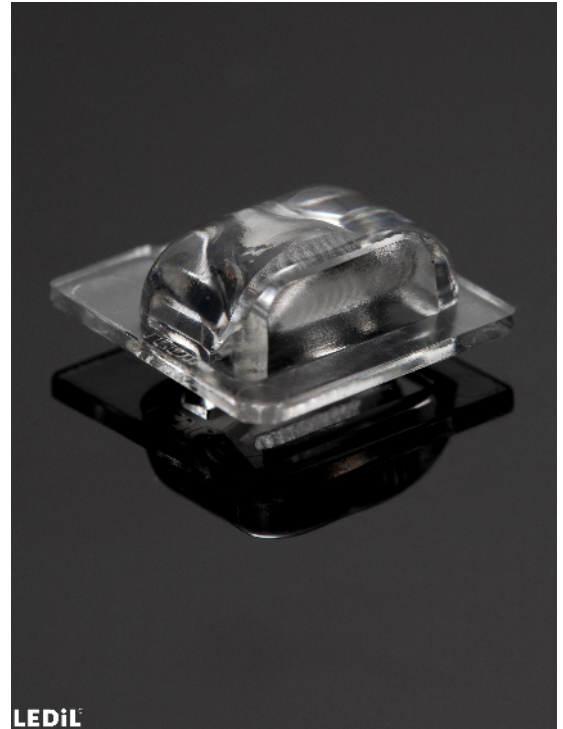

### MATERIALS:

Component	Type	Material	Colour	Finish
STRADELLA-T2	Single lens	PMMA	clear	

### ORDERING INFORMATION:

Component	Qty in box	MOQ	MPQ	Box weight (kg)
C14502_STRADELLA-T2 » Box size: 480 x 250 x 390 mm	16000	1000	1000	9.8

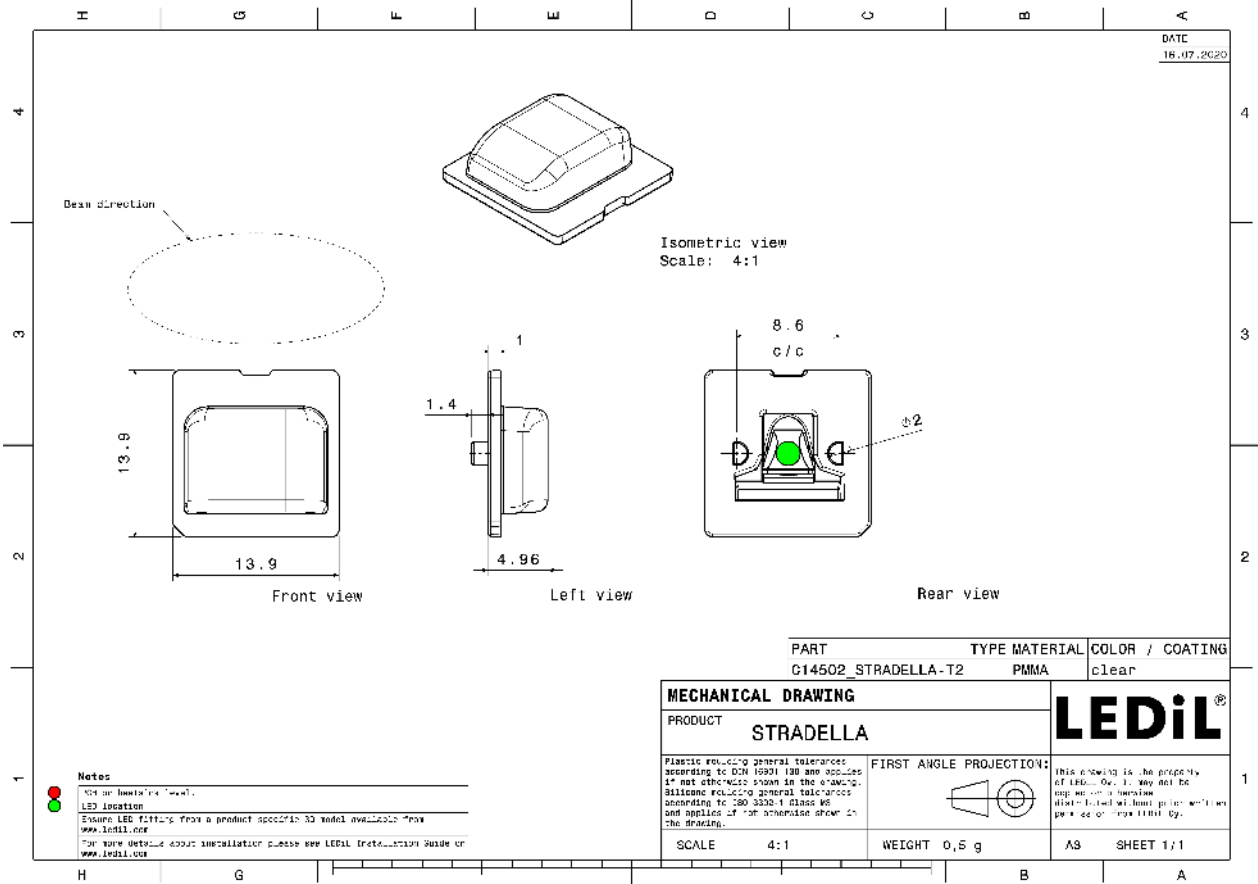

See also our general installation guide: [www.ledil.com/installation\\_guide](http://www.ledil.com/installation_guide)

### OPTICAL RESULTS (MEASURED):

#### CREE → LED

LED J Series 3030  
 FWHM / FWTM Asymmetric  
 Efficiency 97 %  
 Peak intensity 0.8 cd/lm  
 LEDs/each optic 1  
 Light colour White  
 Required components:

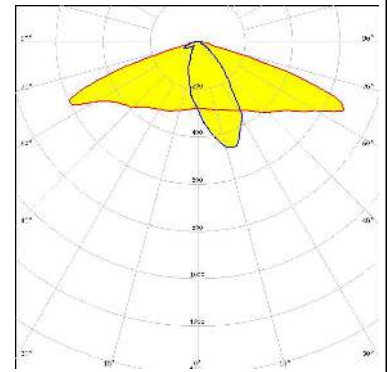

#### CREE → LED

LED XP-G2  
 FWHM / FWTM Asymmetric  
 Efficiency 94 %  
 Peak intensity 0.8 cd/lm  
 LEDs/each optic 1  
 Light colour White  
 Required components:

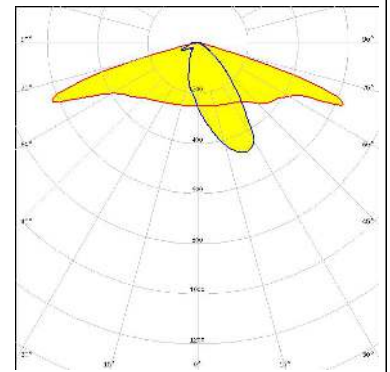

#### CREE → LED

LED XP-G3  
 FWHM / FWTM Asymmetric  
 Efficiency 94 %  
 Peak intensity 0.8 cd/lm  
 LEDs/each optic 1  
 Light colour White  
 Required components:

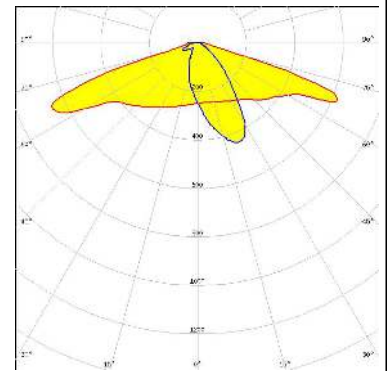

#### CREE → LED

LED XT-E  
 FWHM / FWTM Asymmetric  
 Efficiency 94 %  
 Peak intensity 0.8 cd/lm  
 LEDs/each optic 1  
 Light colour White  
 Required components:

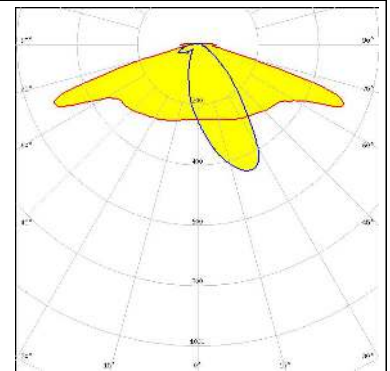





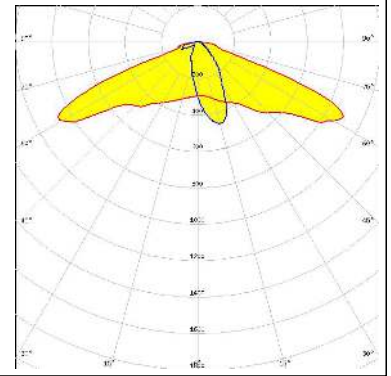

## OPTICAL RESULTS (MEASURED):

### SAMSUNG

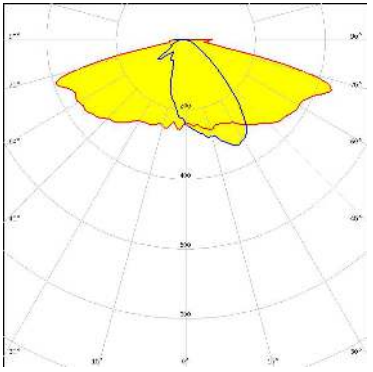
LED LH181B  
FWHM / FWTM Asymmetric  
Efficiency 94 %  
Peak intensity 1 cd/lm  
LEDs/each optic 1  
Light colour White  
Required components:

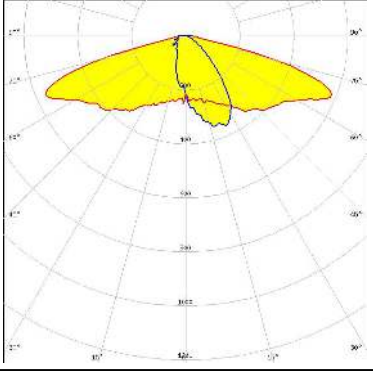

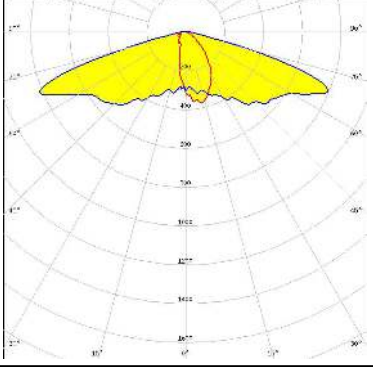

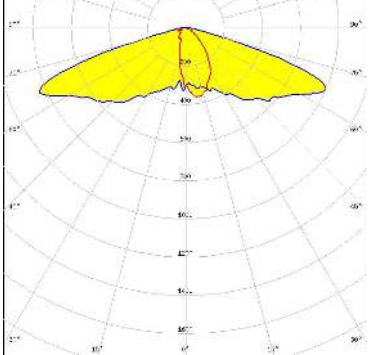

#### OPTICAL RESULTS (SIMULATED):

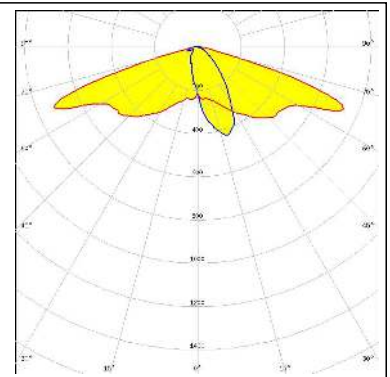
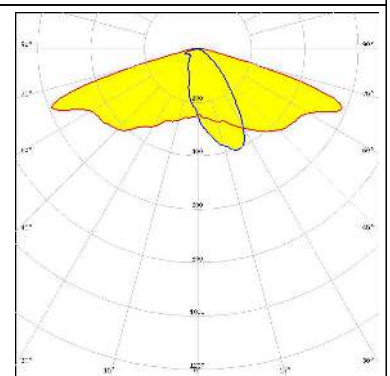
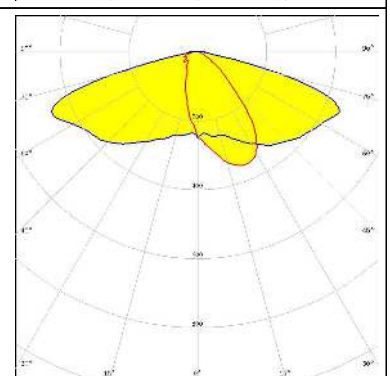
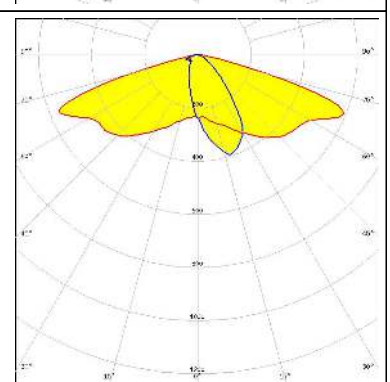
	<p>LED XP-G2 HE            FWHM / FWTM Asymmetric            Efficiency 93 %            Peak intensity 0.5 cd/lm            LEDs/each optic 1            Light colour White            Required components:</p>	
	<p>LED NVSxx19B/NVSxx19C            FWHM / FWTM Asymmetric            Efficiency 94 %            Peak intensity 0.6 cd/lm            LEDs/each optic 1            Light colour White            Required components:</p>	
	<p>LED Duris S5 (2 chip)            FWHM / FWTM Asymmetric            Efficiency 97 %            Peak intensity 0.8 cd/lm            LEDs/each optic 1            Light colour White            Required components:</p>	
	<p>LED Duris S5 (Single chip)            FWHM / FWTM Asymmetric            Efficiency 96 %            Peak intensity 0.9 cd/lm            LEDs/each optic 1            Light colour White            Required components:</p>	

#### OPTICAL RESULTS (SIMULATED):

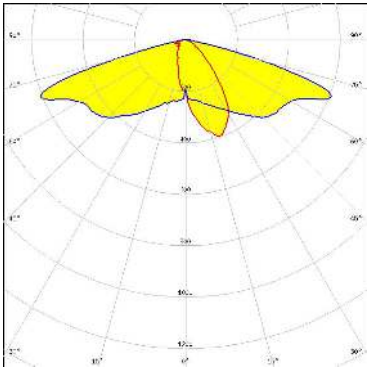
<p><b>OSRAM</b> Opto Semiconductors</p> <p>LED: OSCONIQ C 2424</p> <p>FWHM / FWTM: Asymmetric</p> <p>Efficiency: 97 %</p> <p>Peak intensity: 0.9 cd/lm</p> <p>LEDs/each optic: 1</p> <p>Light colour: White</p> <p>Required components:</p>	
<p><b>OSRAM</b> Opto Semiconductors</p> <p>LED: OSCONIQ P 3737 (2W version)</p> <p>FWHM / FWTM: Asymmetric</p> <p>Efficiency: 94 %</p> <p>Peak intensity: 0.7 cd/lm</p> <p>LEDs/each optic: 1</p> <p>Light colour: White</p> <p>Required components:</p>	
<p><b>SAMSUNG</b></p> <p>LED: LH351B</p> <p>FWHM / FWTM: Asymmetric</p> <p>Efficiency: 93 %</p> <p>Peak intensity: 0.5 cd/lm</p> <p>LEDs/each optic: 1</p> <p>Light colour: White</p> <p>Required components:</p>	
<p><b>SAMSUNG</b></p> <p>LED: LM301B</p> <p>FWHM / FWTM: Asymmetric</p> <p>Efficiency: 96 %</p> <p>Peak intensity: 0.7 cd/lm</p> <p>LEDs/each optic: 1</p> <p>Light colour: White</p> <p>Required components:</p>	

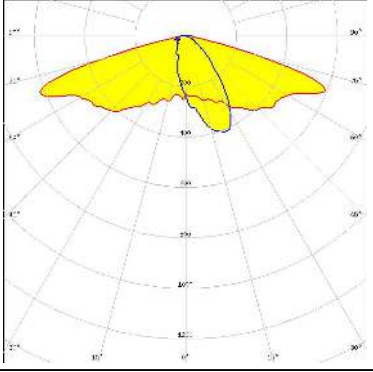
### OPTICAL RESULTS (SIMULATED):

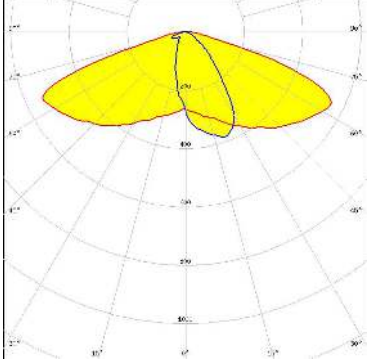
<p> SEOUL SEMICONDUCTOR</p> <p>LED: SEOUL DC 3030</p> <p>FWHM / FWTM: Asymmetric</p> <p>Efficiency: 96 %</p> <p>Peak intensity: 0.7 cd/lm</p> <p>LEDs/each optic: 1</p> <p>Light colour: White</p> <p>Required components:</p>	
<p> SEOUL SEMICONDUCTOR</p> <p>LED: Z5M1/Z5M2</p> <p>FWHM / FWTM: Asymmetric</p> <p>Efficiency: 94 %</p> <p>Peak intensity: 0.7 cd/lm</p> <p>LEDs/each optic: 1</p> <p>Light colour: White</p> <p>Required components:</p>	
<p> SEOUL SEMICONDUCTOR</p> <p>LED: Z5M4</p> <p>FWHM / FWTM: Asymmetric</p> <p>Efficiency: 96 %</p> <p>Peak intensity: 0.6 cd/lm</p> <p>LEDs/each optic: 1</p> <p>Light colour: White</p> <p>Required components:</p>	

### GENERAL INFORMATION:

NOTE: The typical beam angle will be changed by different color, chip size and chip position tolerance. The typical total beam angle is the full angle measured where the luminous intensity is half of the peak value.

### MATERIALS:

As part of our continuous research and improvement processes, and to ensure the best possible quality and availability of our products, LEDiL reserves the right to change material grades without notice.

### PRODUCT DATA USER AGREEMENT AND DISCLAIMER:

The measured data in the provided downloadable LEDiL Product Datasheets and Mechanical 2D-Drawings is rounded and provided as reference for planning. LEDiL Oy's optical specifications have been verified by conducting performance testing of the products in accordance with the company's quality system. The reported data are averaged results of multiple measurements with typical variation. LEDiL Oy reserves the right to without prior notification make changes and improvements to its products.

LEDiL Oy assumes neither warranty, nor guarantee nor any other liability of any kind for the contents and correctness of the provided data. The provided data has been generated with highest diligence but the provided data may in reality not represent the complete possible variation range of all intrinsic parameters. Therefore, in certain cases a deviation from the provided data could occur.

LEDiL Oy reserves the right to undertake technical changes of its products without further notification which could lead to changes in the provided data. LEDiL Oy assumes no liability of any kind for the possible deviation from any provided data or any other damage resulting from the usage of the provided data.

The user agrees to this disclaimer and user agreement with the download or usage of the provided files.

#### LEDiL Oy

Joensuunkatu 13  
FI-24240 SALO  
Finland

#### LEDiL Inc.

228 West Page Street  
Suite D  
Sycamore IL 60178  
USA

#### Ledil Optics Technology (Shenzhen) Co., Ltd.

# 405 , Block B  
Casic Motor Building  
Shenzhen 518057  
P.R.CHINA

#### Local sales and technical support

[www.ledil.com/  
where\\_to\\_buy](http://www.ledil.com/where_to_buy)

#### Shipping locations

Salo, Finland  
Hong Kong, China

#### Distribution Partners

[www.ledil.com/  
where\\_to\\_buy](http://www.ledil.com/where_to_buy)