

# TPS5120-Q1

## DUAL OUTPUT, TWO-PHASE SYNCHRONOUS BUCK DC/DC CONTROLLER

SGLS225B – JANUARY 2004 – REVISED APRIL 2008

- Qualified for Automotive Applications
- Independent Dual-Outputs Operate 180° Out of Phase
- Wide Input Voltage Range: 4.5-V – 28-V
- Adjustable Output Voltage Down to 0.9 V
- Pin-Selectable PWM/SKIP Mode for High Efficiency Under Light Loads
- Synchronous Buck Operation Allows up to 95% Efficiency
- Separate Standby Control and Overcurrent Protection For Each Channel
- Programmable Short-Circuit Protection
- Low Supply (1 mA) and Shutdown (1 nA) Current
- Power Good Output
- High-Speed Error Amplifiers
- Sequencing Easily Achieved by Selecting Softstart Capacitor Values.
- 5-V Linear Regulator Power Internal IC Circuitry
- 30-Pin TSSOP Packaging
- Gate Leakage Test Passing Level is 50 V

DBT PACKAGE  
(TOP VIEW)

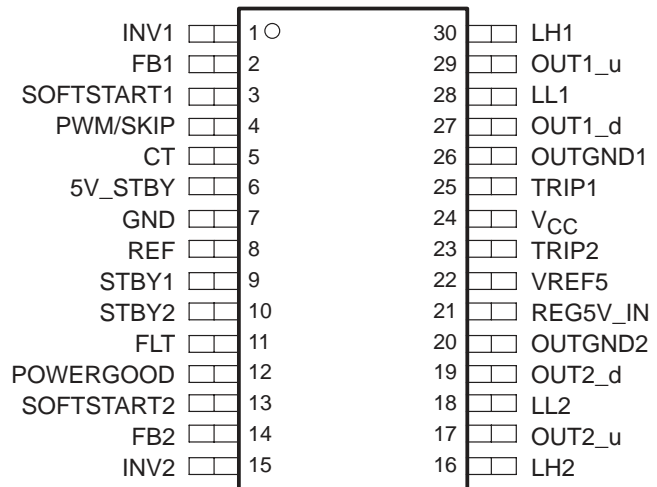

### description

The TPS5120 is a dual channel, high-efficiency synchronous buck controller where the outputs run 180 degrees out of phase, which lowers the input current ripple, thereby reducing the input capacitance cost. The PWM/SKIP pin allows the operating mode to switch from PWM mode to skip mode under light load conditions. The skip mode enables a lower operating frequency and shortens the pulse width to the low-side MOSFET, increasing the efficiency under light load conditions. These two modes, along with synchronous-rectifier drivers, dead time, and very low quiescent current, allow power to be conserved and the battery life to be extended under all load conditions. The 1.5 A (typical) high-side and low-side MOSFET drivers on-chip are designed to drive less expensive N-channel MOSFETs. The resistorless current protection and fixed high-side driver voltage simplify the power supply design and reduce the external parts count. Each channel is independent, offering a separate controller, overcurrent protection, and standby control. Sequencing is flexible and can be tailored by choosing different softstart capacitor values. Other features, such as undervoltage lockout, power good, overvoltage, undervoltage, and programmable short-circuit protection promote system reliability.

### ORDERING INFORMATION†

| T <sub>A</sub> | PACKAGE‡       |
|----------------|----------------|
|                | TSSOP (DBT)    |
| -40°C to 125°C | TPS5120QDBTRQ1 |

† For the most current package and ordering information, see the Package Option Addendum at the end of this document, or see the TI web site at <http://www.ti.com>.

‡ Package drawings, thermal data, and symbolization are available at <http://www.ti.com/packaging>.



Please be aware that an important notice concerning availability, standard warranty, and use in critical applications of Texas Instruments semiconductor products and disclaimers thereto appears at the end of this data sheet.

PRODUCTION DATA information is current as of publication date. Products conform to specifications per the terms of Texas Instruments standard warranty. Production processing does not necessarily include testing of all parameters.



POST OFFICE BOX 655303 • DALLAS, TEXAS 75265

Copyright © 2008 Texas Instruments Incorporated

# TPS5120-Q1 DUAL OUTPUT, TWO-PHASE SYNCHRONOUS BUCK DC/DC CONTROLLER

SGLS225B – JANUARY 2004 – REVISED APRIL 2008

## typical design

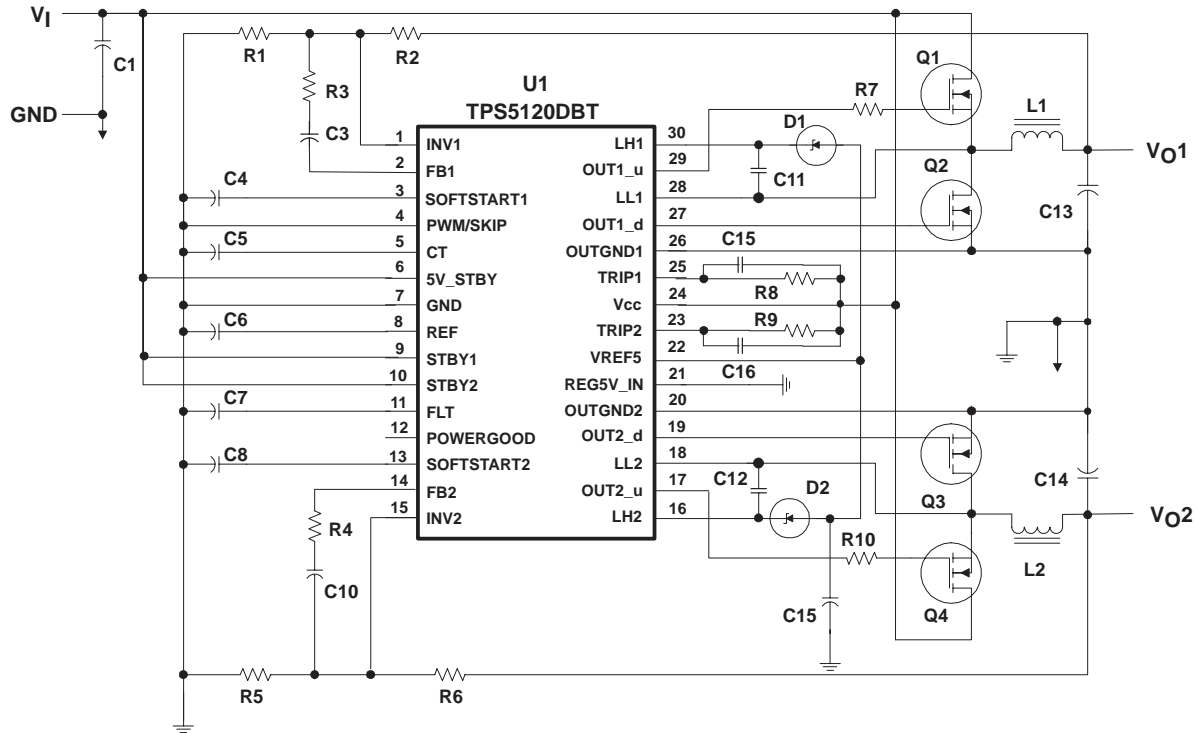

Figure 1. EVM Typical Design

# TPS5120-Q1

## DUAL OUTPUT, TWO-PHASE SYNCHRONOUS BUCK DC/DC CONTROLLER

SGLS225B – JANUARY 2004 – REVISED APRIL 2008

### functional block diagram

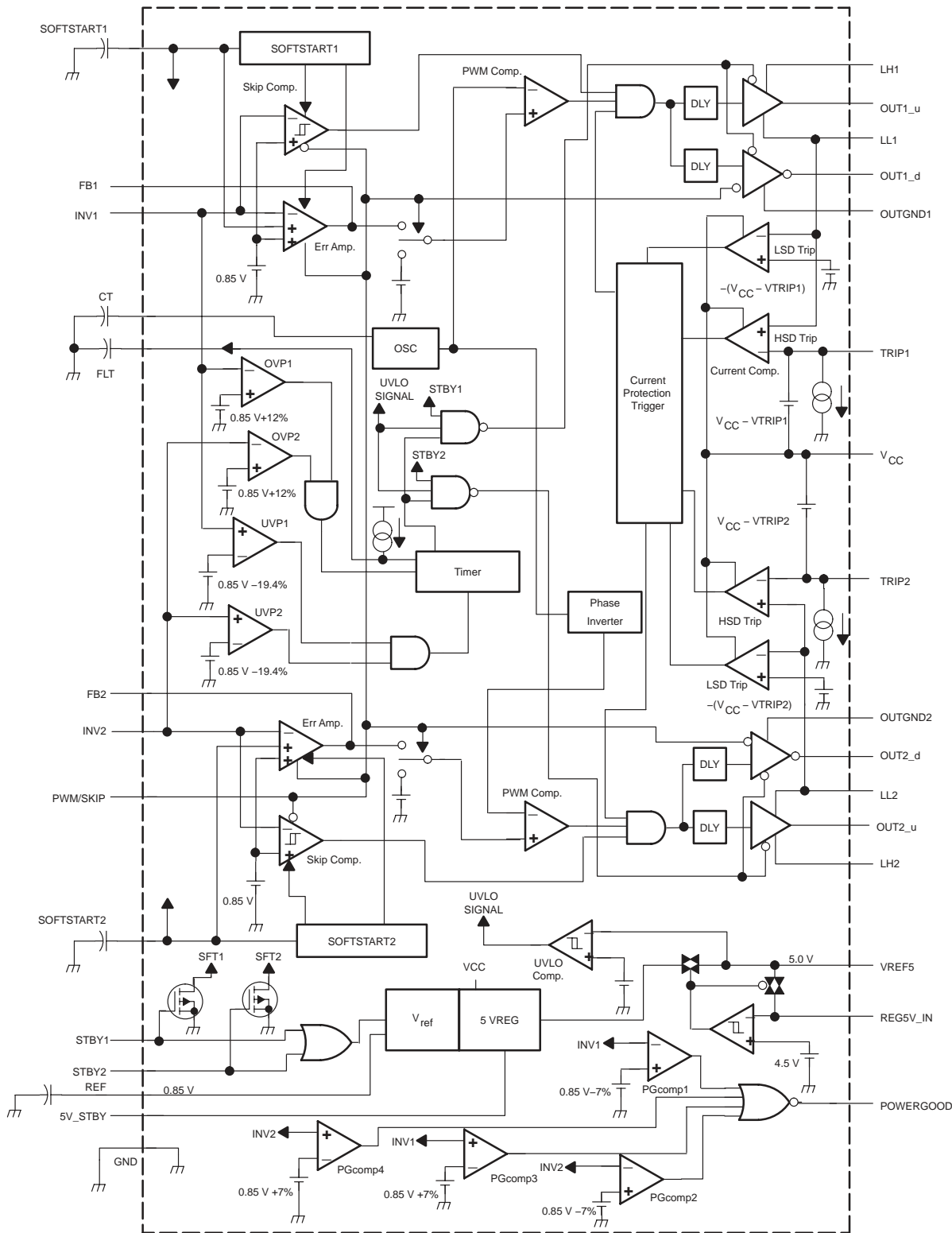

# TPS5120-Q1

## DUAL OUTPUT, TWO-PHASE SYNCHRONOUS BUCK DC/DC CONTROLLER

SGLS225B – JANUARY 2004 – REVISED APRIL 2008

### Terminal Functions

| TERMINAL NAME | NO. | I/O | DESCRIPTION   |
|---------------|-----|-----|---|
| CT            | 5   | I/O | External capacitor from CT to GND for adjusting the triangle oscillator   |
| FB1           | 2   | O   | Feedback output of CH1 error amplifier  |
| FB2           | 14  | O   | Feedback output of CH2 error amplifier  |
| GND           | 7   |     | Control GND   |
| INV1          | 1   | I   | Inverting input of the CH1 error amplifier, skip comparator, and OVP1/UVP1 comparator   |
| INV2          | 15  | I   | Inverting input of the CH2 error amplifier, skip comparator, and OVP2/UVP2 comparator   |
| LH1           | 30  | I/O | Bootstrap capacitor connection for CH1 high-side gate drive   |
| LH2           | 16  | I/O | Bootstrap capacitor connection for CH2 high-side gate drive   |
| LL1           | 28  | I/O | Bootstrap this pin low for CH1 high-side gate driving return and output current protection. Connect this pin to the junction of the high-side and low-side FETs for a floating drive configuration.   |
| LL2           | 18  | I/O | Bootstrap this pin low for CH2 high-side gate driving return and output current protection. Connect this pin to the junction of the high-side and low-side FETs for a floating drive configuration.   |
| OUT1_d        | 27  | O   | Gate drive output for CH1 low-side gate drive   |
| OUT2_d        | 19  | O   | Gate drive output for CH2 low-side gate drive   |
| OUT1_u        | 29  | O   | Gate drive output for CH1 high-side switching FETs  |
| OUT2_u        | 17  | O   | Gate drive output for CH2 high-side switching FETs  |
| OUTGND1       | 26  |     | Ground for CH1 FET drivers  |
| OUTGND2       | 20  |     | Ground for CH2 FET drivers  |
| POWERGOOD     | 12  | O   | Power good open-drain output. When low, POWERGOOD reports an output fail condition. PG comparators monitor both SMPS's over voltage and UVLO of VREF5. The threshold is $\pm 7\%$ . When the SMPS starts up, the POWERGOOD pin's output goes high. POWERGOOD also monitors VREF5's UVLO output.   |
| PWM/SKIP      | 4   | I   | PWM/SKIP mode select pin. The PWM/SKIP pin is used to change the output's operating mode. If this terminal is lower than 0.5 V, it works in PWM mode. When a minimum voltage of 2 V is applied, the device operates in skip mode. In light load condition (< 0.2 A), the skip mode gives a short pulse to the low-side FETs instead of a full pulse. With this control, switching frequency is lowered and switching loss is reduced. Also, the output capacitor energy discharging through the output inductor and low-side FETs is stopped. Therefore, TPS5120 achieves a higher efficiency in light load conditions. |
| REF           | 8   | O   | 0.85-V reference voltage output. The 0.85-V reference voltage is used for setting the output voltage and the voltage protection. This reference voltage is dropped down from a 5-V regulator.   |
| REG5V_IN      | 21  | I   | External 5-V input  |
| FLT           | 11  | I/O | Fault latch timer pin. An external capacitor is connected between FLT and GND to set the FLT enable time up.  |
| SOFTSTART1    | 3   | I/O | External capacitor from SOFTSTART1 to GND for CH1 softstart control. Separate soft-start terminals make it possible to set the start-up time of each output independently.  |
| SOFTSTART2    | 13  | I/O | External capacitor from SOFTSTART2 to GND for CH2 softstart control. Separate soft-start terminals make it possible to set the start-up time of each output independently.  |
| STBY1         | 9   | I   | Standby control for CH1. SMPS1 can be switched into standby mode separately by grounding the STBY1 pin.   |
| STBY2         | 10  | I   | Standby control for CH2. SMPS2 can be switched into standby mode separately by grounding the STBY2 pin.   |
| TRIP1         | 25  | I   | External resistor connection for CH1 output current control   |
| TRIP2         | 23  | I   | External resistor connection for CH2 output current control   |
| VCC           | 24  |     | Supply voltage input  |
| VREF5         | 22  | O   | 5-V internal regulator output   |
| 5V_STBY       | 6   | I   | 5-V linear regulator control  |



## detailed description

### switching-mode power supply (SMPS) 1, 2

The TPS5120 includes dual SMPS controllers that operate 180° out of phase and at the same frequency. Both channels have standby and softstart.

### 5-V regulator

An internal linear voltage regulator is used for the high-side driver bootstrap voltage and source of VREF (0.85 V). When the 5-V regulator is disconnected from the MOSFET drivers, it is only used for the source of VREF. Since the input voltage range is from 4.5 V to 28 V, this feature offers a fixed voltage for the bootstrap voltage so that the drive design is much easier. It is also used for powering the low-side driver. The tolerance is 4%. The 5-V regulator is disabled when STBY1, STBY2, and 5V\_STBY are all set low.

### 5-V switch

If the internal 5-V switch senses the 5-V input from the REG5V\_IN pin, the internal 5-V linear regulator is disconnected from the MOSFET drivers. The external 5 V is then used for both the low-side driver and the high-side bootstrap, thus, increasing the efficiency.

### error amplifier

Each channel has its own error amplifier to regulate the output voltage of the synchronous buck converter. It is used in the PWM mode for the high output current condition (> 0.2 A). The unity gain bandwidth is 2.5 MHz. This decreases the amplifier delay during fast load transients and contributes to a fast transient response.

### skip comparator

In skip mode, each channel has its own hysteretic comparator to regulate the output voltage of the synchronous buck converter. The hysteresis is set internally and is typically set at 9 mV. The delay from the comparator input to the driver output is typically 1.2 μs.

### low-side driver

The low-side driver is designed to drive low  $r_{ds(on)}$  N-channel MOSFETs. The maximum drive voltage is 5 V from VREF5. The current rating of the driver is typically 1.5 A at source and sink.

### high-side driver

The high-side driver is designed to drive low  $r_{ds(on)}$  N-channel MOSFETs. The current rating of the driver is 1.2 A at source and sink. When configured as a floating driver, the bias voltage to the driver is developed from VREF5, limiting the maximum drive voltage between OUTx\_u and LLx to 5 V. The maximum voltage that can be applied between LHx and OUTGND is 33 V.

### deadtime

Deadtime prevents shoot through current from flowing through the main power FETs during switching transitions by actively controlling the turnon time of the MOSFETs drivers.

### current protection

Overcurrent protection is achieved by comparing the drain-to-source voltage of the high-side and low-side MOSFET devices to a set-point voltage. This voltage is set using an external resistor between V<sub>CC</sub> and the TRIP1 or TRIP2 terminals. If the drain-to-source voltage up exceeds the set-point voltage during high-side conduction, the current limit circuit terminates the high-side driver pulse. If the set-point voltage is exceeded during low-side conduction, the low-side pulse is extended through the next cycle. Together this action has the effect of decreasing the output voltage until the undervoltage protection circuit is activated and the fault latch is set and both the high and low-side MOSFET drivers are shut off.

# TPS5120-Q1

## DUAL OUTPUT, TWO-PHASE SYNCHRONOUS BUCK DC/DC CONTROLLER

SGLS225B – JANUARY 2004 – REVISED APRIL 2008

---

### detailed description (continued)

#### overvoltage protection

For overvoltage protection (OVP), the TPS5120 monitors INV pin voltage. When the INV voltage is higher than 0.95 V (+12%), the OVP comparator output goes high and the FLT timer starts to charge an external capacitor connected to FLT. After a set time, the FLT circuit latches the MOSFET drivers off.

#### undervoltage protection

For undervoltage protection (UVP), the TPS5120 monitors INV pin voltage. When the INV voltage is lower than 0.68 V (–19.4%), the OVP comparator output goes high, and the FLT timer starts to charge an external capacitor connected to FLT. Also, when the current comparator triggers the OCP, the UVP comparator detects the under voltage output and starts the FLT capacitor charge. After a set time, the FLT circuit latches off all of the MOSFET drivers.

#### FLT

When an OVP or UVP comparator output goes high, the FLT circuit starts to charge the FLT capacitor. If the FLT pin voltage goes beyond a constant level, the TPS5120 latches the MOSFET drivers. At this time, the state of MOSFET is different depending on the OVP alert and the UVP alert. Also, the enable time used to latch the MOSFET driver is decided by the capacity of the FLT capacitor. The charging constant current value is also different depending on whether it is an OVP alert or a UVP alert. The difference is shown in the following equation:

$$\text{FLT source current (OVP)} = \text{FLT source current (UVP)} \times 5$$

#### shutdown

The TPS5120 can be shut down by grounding STBY1, STBY2, and 5V\_STBY. The shutdown current is as low as 1  $\mu$ A.

#### UVLO

When the input voltage goes up to about 4 V, the TPS5120 is operational. When the input voltage is lower than the turnon value, the device is turned off. The typical hysteresis voltage is 40 mV.

#### phase Inverter

Phase inverter controls the phase of SMPS1 and SMPS 2. SMPS1 operates in phase with the OSC. SMPS2 operates 180° out of phase from SMPS1. This allows smaller input capacitors to be used.

#### oscillator

The TPS5120 has a triangle oscillator generator internal to the IC. The oscillation frequency is set by the size of the capacitor connected to the CT pin. The voltage amplitude is 0.43 V ~ 1.17 V.



# TPS5120-Q1

## DUAL OUTPUT, TWO-PHASE SYNCHRONOUS BUCK DC/DC CONTROLLER

SGLS225B – JANUARY 2004 – REVISED APRIL 2008

**Table 1. Logic Chart**

| 5V_STBY | STBY1 | STBY2 | SMPS1   | SMPS2   | 5 V REGULATOR | POWERGOOD |
|---------|-------|-------|---------|---------|---------------|-----------|
| L       | L     | L     | Disable | Disable | Disable       | Disable   |
| L       | L     | H     | Disable | Enable  | Enable        | Active†   |
| L       | H     | L     | Enable  | Disable | Enable        | Active†   |
| L       | H     | H     | Enable  | Enable  | Enable        | Active    |
| H       | L     | L     | Disable | Disable | Enable        | L         |
| H       | L     | H     | Disable | Enable  | Enable        | Active†   |
| H       | H     | L     | Enable  | Disable | Enable        | Active†   |
| H       | H     | H     | Enable  | Enable  | Enable        | Active    |

† PG is set high during a softstart.

### POWERGOOD timing sequence

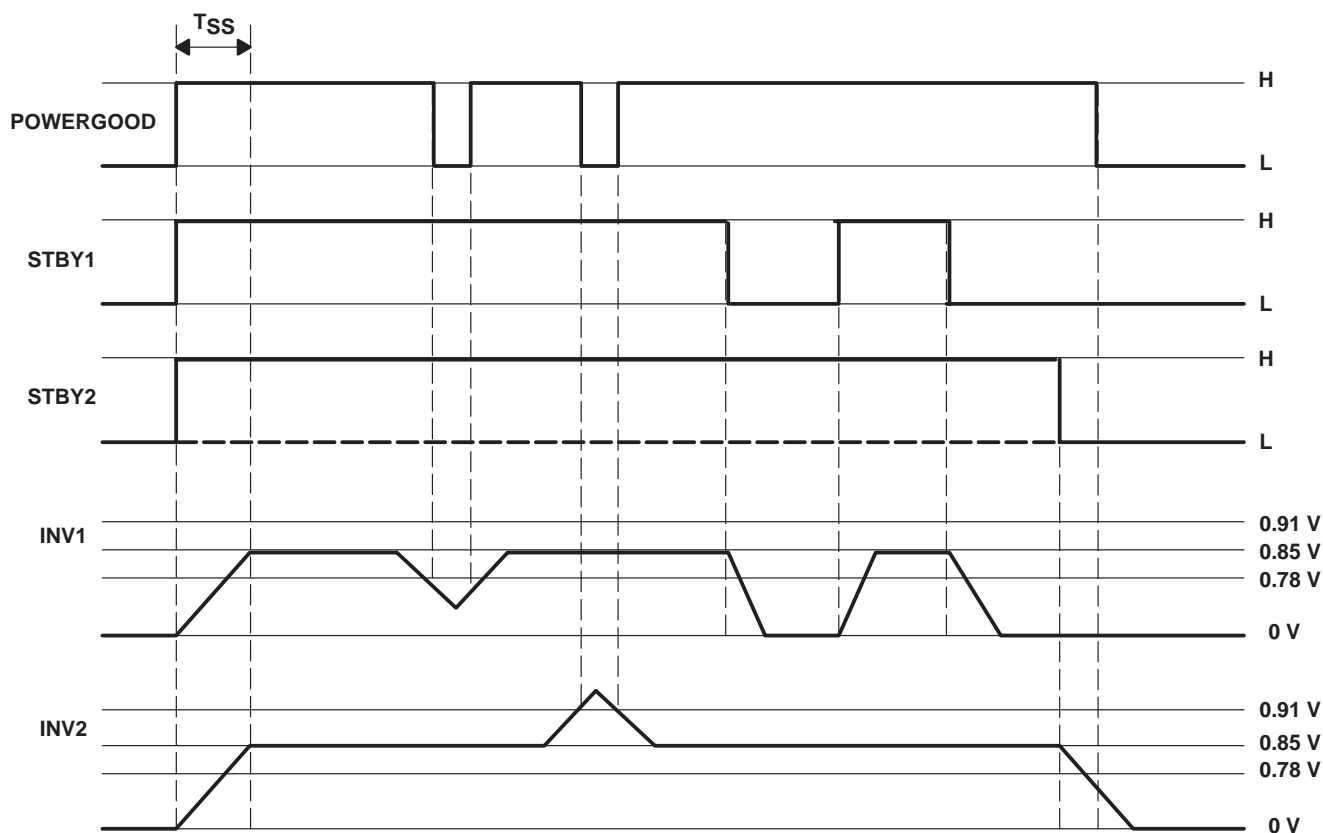

During a softstart, this channel's powergood comparator output is fixed low (POWERGOOD output is high).

# TPS5120-Q1

## DUAL OUTPUT, TWO-PHASE SYNCHRONOUS BUCK DC/DC CONTROLLER

SGLS225B – JANUARY 2004 – REVISED APRIL 2008

### absolute maximum ratings over operating free-air temperature (unless otherwise noted)†

|  |                |
|--|----------------|
| Supply voltage, $V_{CC}$ (see Note 1)  | –0.3 V to 30 V |
| Input voltage: INV1, INV2, CT, PWM/SKIP, REG5V_IN, SOFTSTART1, SOFTSTART2, . . . . | –0.3 V to 7 V  |
| FLT, POWERGOOD   | –0.3 V to 7 V  |
| STBY1, STBY2, 5V_STBY, TRIP1, TRIP2  | –0.3 V to 30 V |
| Output voltage: LL1, LL2   | –1.0 V to 30 V |
| OUT1_u, OUT2_u   | –1.0 V to 35 V |
| LH1, LH2   | –0.3 V to 35 V |
| OUT1_d, OUT2_d, 5V_OUT, FB1, FB2   | –0.3 V to 7 V  |
| REF  | –0.3 V to 3 V  |
| OUT1_u, LH1 to LL1   | –0.3 V to 7 V  |
| OUT2_u, LH2 to LL2   | –0.3 V to 7 V  |
| Power dissipation ( $T_A \leq 25^\circ\text{C}$ ), $P_D$                           | 874 mW         |
| Gate Leakage Test Results  | $\pm 50$ V     |
| Operating junction temperature range, $T_J$  | –40°C to 125°C |
| Storage temperature range, $T_{stg}$   | –55°C to 150°C |

† Stresses beyond those listed under “absolute maximum ratings” may cause permanent damage to the device. These are stress ratings only, and functional operation of the device at these or any other conditions beyond those indicated under “recommended operating conditions” is not implied. Exposure to absolute-maximum-rated conditions for extended periods may affect device reliability.

- NOTES: 1. All voltage values are with respect to the network ground terminal unless otherwise noted.  
 2. This rating is specified at duty = 10% on output rise and fall each pulse. Each pulse width (rise and fall) for the peak current should not exceed 2  $\mu\text{s}$ .  
 3. See Dissipation Rating Table for free-air temperature range above 25°C.

DISSIPATION RATING TABLE

| PACKAGE | $T_A \leq 25^\circ\text{C}$ | DERATING FACTOR                | POWER DISSIPATION        |
|---------|-----------------------------|--------------------------------|--------------------------|
|         | POWER RATING                | ABOVE $T_A = 25^\circ\text{C}$ | $T_A = 85^\circ\text{C}$ |
| DBT     | 874 mW                      | 6.993 mW/°C                    | 454 mW                   |

### recommended operating conditions

|   |   | MIN  | NOM | MAX | UNIT |
|---|---|------|-----|-----|------|
| Supply voltage, $V_{CC}$                    |   | 4.5  |     | 28  | V    |
| Input voltage, $V_I$                        | INV1, INV2, CT, PWM/SKIP, SOFTSTART1, SOFTSTART2, FLT |      |     | 6   | V    |
|   | REG5V_IN, POWERGOOD                                   | –0.1 |     | 5.5 |      |
|   | STBY1, STBY2, 5V_STBY                                 |      |     | 28  |      |
|   | OUT1_u, OUT2_u, LH1, LH2                              |      |     | 33  |      |
|   | TRIP1, TRIP2  | –0.1 |     | 28  |      |
| Oscillator frequency, $f_{osc}$             |   |      | 300 | 500 | kHz  |
| Operating junction temperature range, $T_J$ |   | –40  |     | 125 | °C   |





# TPS5120-Q1

## DUAL OUTPUT, TWO-PHASE SYNCHRONOUS BUCK DC/DC CONTROLLER

SGLS225B – JANUARY 2004 – REVISED APRIL 2008

electrical characteristics over recommended free-air temperature range,  $V_{CC} = 7\text{ V}$  (unless otherwise noted)

### reference voltage

| PARAMETER      |                             | TEST CONDITIONS  | MIN   | TYP  | MAX  | UNIT |
|----------------|-----------------------------|--|-------|------|------|------|
| $V_{ref}$      | Reference voltage           |  |       | 0.85 |      | V    |
| $V_{ref(tol)}$ | Reference voltage tolerance | $T_A = 25^\circ\text{C}$ , $I = 50\ \mu\text{A}$                         | -1%   |      | 1%   |      |
|                |                             | $T_J = -20^\circ\text{C}$ to $125^\circ\text{C}$ , $I = 50\ \mu\text{A}$ | -1.5% |      | 1.5% |      |
|                |                             | $T_J = -40^\circ\text{C}$ to $125^\circ\text{C}$ , $I = 50\ \mu\text{A}$ | -2%   |      | 2%   |      |
| $R_{(egin)}$   | Line regulation             | $V_{CC} = 4.5\text{ V}$ to $28\text{ V}$ , $I = 50\ \mu\text{A}$         |       | 0.05 | 3    | mV   |
| $R_{(egl)}$    | Load regulation             | $I = 0.1\ \mu\text{A}$ to $1\text{ mA}$                                  |       | 0.15 | 5    | mV   |

### oscillator

| PARAMETER |                           | TEST CONDITIONS   | MIN | TYP  | MAX | UNIT |
|-----------|---------------------------|---|-----|------|-----|------|
| $f_{osc}$ | Frequency                 | PWM mode, $C_T = 44\text{ pF}$ , $T_A = 25^\circ\text{C}$ |     | 300  |     | kHz  |
| $V_{OH}$  | High level output voltage | DC  | 1   | 1.1  | 1.2 | V    |
|           |                           | $f_{osc} = 300\text{ kHz}$                                |     | 1.17 |     |      |
| $V_{OL}$  | Low level output voltage  | DC  | 0.4 | 0.5  | 0.6 | V    |
|           |                           | $f_{osc} = 300\text{ kHz}$                                |     | 0.43 |     |      |

### error amplifier

| PARAMETER   |                        | TEST CONDITIONS          | MIN | TYP | MAX | UNIT |
|-------------|------------------------|--------------------------|-----|-----|-----|------|
| $V_{IO}$    | Input offset voltage   | $T_A = 25^\circ\text{C}$ |     | 2   | 10  | mV   |
|             | Open-loop voltage gain |                          | 50  |     |     | dB   |
|             | Unity-gain bandwidth   |                          |     | 2.5 |     | MHz  |
| $I_{(snk)}$ | Output sink current    | $V_O = 1\text{ V}$       | 0.3 | 0.7 |     | mA   |
| $I_{(src)}$ | Output source current  | $V_O = 1\text{ V}$       | 0.2 | 0.9 |     | mA   |

### skip comparator

| PARAMETER |                   | TEST CONDITIONS | MIN | TYP | MAX | UNIT |
|-----------|-------------------|-----------------|-----|-----|-----|------|
| $V_{hys}$ | Hysteresis window | SKIP mode       |     | 9   |     | mV   |

### duty control

| PARAMETER |                    | TEST CONDITIONS             | MIN | TYP | MAX | UNIT |
|-----------|--------------------|-----------------------------|-----|-----|-----|------|
| DUTY      | Maximum duty cycle | 300 kHz, $V_I = 0\text{ V}$ |     | 83% |     |      |

### control

| PARAMETER |                          | TEST CONDITIONS   | MIN | TYP | MAX | UNIT |
|-----------|--------------------------|-------------------|-----|-----|-----|------|
| $V_{IH}$  | High-level input voltage | STBY1, STBY2      | 2.2 |     |     | V    |
|           |                          | PWM/SKIP, 5V_STBY | 2.2 |     |     |      |
| $V_{IL}$  | Low-level input voltage  | STBY1, STBY2      |     |     | 0.3 | V    |
|           |                          | PWM/SKIP, 5V_STBY |     |     | 0.3 |      |

### 5-V internal switch

| PARAMETER     |            | TEST CONDITIONS | MIN | TYP | MAX | UNIT |
|---------------|------------|-----------------|-----|-----|-----|------|
| $V_{(TO\_H)}$ | Threshold  |                 | 4.2 |     | 4.8 | V    |
| $V_{(TO\_L)}$ |            |                 | 4.1 |     | 4.7 |      |
| $V_{hys}$     | Hysteresis |                 | 30  |     | 200 | mV   |



# TPS5120-Q1

## DUAL OUTPUT, TWO-PHASE SYNCHRONOUS BUCK DC/DC CONTROLLER

SGLS225B – JANUARY 2004 – REVISED APRIL 2008

electrical characteristics over recommended free-air temperature range,  $V_{CC} = 7\text{ V}$  (unless otherwise noted) (continued)

### 5-V regulator

| PARAMETER     |                              | TEST CONDITIONS   | MIN | TYP | MAX | UNIT |
|---------------|------------------------------|---|-----|-----|-----|------|
| $V_O$         | Output voltage               | $I_O = 0\text{ mA to }50\text{ mA}$ ,<br>$T_A = 25^\circ\text{C}$ | 4.8 |     | 5.2 | V    |
| $R_{(egin)}$  | Line regulation              | $V_{CC} = 5.5\text{ V to }28\text{ V}$ ,<br>$I = 10\text{ mA}$    |     |     | 20  | mV   |
| $R_{(egl)}$   | Load regulation              | $I = 1\text{ mA to }10\text{ mA}$ ,<br>$V_{CC} = 5.5\text{ V}$    |     |     | 40  | mV   |
| $I_{OS}$      | Short circuit output current | $5V_{REG} = 0\text{ V}$ ,<br>$T_A = 25^\circ\text{C}$             | 65  |     |     | mA   |
| $V_{(TO\_H)}$ | UVLO threshold voltage       | 5V_OUT voltage  | 3.6 |     | 4.2 | V    |
| $V_{(TO\_L)}$ |                              |   | 3.5 |     | 4.1 |      |
| $V_{hys}$     | Hysteresis                   | 5V_OUT voltage  | 20  |     | 150 | mV   |

### output drivers

| PARAMETER    |                      | TEST CONDITIONS          | MIN  | TYP  | MAX  | UNIT          |
|--------------|----------------------|--------------------------|------|------|------|---------------|
|              | OUT_u sink current   | $V_O = 3\text{ V}$       |      | 1.2  |      | A             |
|              | OUT_u source current | $V_O = 2\text{ V}$       |      | -1.5 |      | A             |
|              | OUT_d sink current   | $V_O = 3\text{ V}$       |      | 1.5  |      | A             |
|              | OUT_d source current | $V_O = 2\text{ V}$       |      | -1.5 |      | A             |
| $I_{(TRIP)}$ | TRIP pin current     | $T_A = 25^\circ\text{C}$ | 11.5 | 13   | 14.5 | $\mu\text{A}$ |

### soft start

| PARAMETER     |                               | TEST CONDITIONS | MIN | TYP | MAX | UNIT          |
|---------------|-------------------------------|-----------------|-----|-----|-----|---------------|
| $I_{(SOFT)}$  | Soft start current            |                 | 1.6 | 2.3 | 2.9 | $\mu\text{A}$ |
| $V_{(TO\_H)}$ | Threshold voltage (SKIP mode) |                 |     | 3.7 |     | V             |
| $V_{(TO\_L)}$ |                               |                 |     | 2.5 |     |               |

### output voltage monitor

| PARAMETER |  | TEST CONDITIONS | MIN  | TYP  | MAX  | UNIT          |
|-----------|--|-----------------|------|------|------|---------------|
|           | OVP comparator threshold                   |                 | 0.91 | 0.95 | 0.99 | V             |
|           | UVP comparator threshold                   |                 | 0.64 | 0.68 | 0.72 | V             |
|           | PG comparator 1, 2 threshold               |                 | 0.75 | 0.78 | 0.81 | V             |
|           | PG comparator 3, 4 threshold               |                 | 0.88 | 0.91 | 0.94 | V             |
|           | PG propagation delay from INV to POWERGOOD | Turnon          |      | 13   |      | $\mu\text{s}$ |
|           |  | Turnoff         |      | 1.2  |      |               |
|           | Timer latch current source                 | UVP protection  | 1.5  | 2.3  | 3.1  | $\mu\text{A}$ |
|           |  | OVP protection  | 8    | 11.5 | 15   |               |

### supply current

| PARAMETER   |                  | TEST CONDITIONS   | MIN | TYP   | MAX | UNIT          |
|-------------|------------------|---|-----|-------|-----|---------------|
| $I_{CC}$    | Supply current   | $T_A = 25^\circ\text{C}$ , $CT = 0\text{ V}$ , $INV = 0\text{ V}$ |     | 1.1   | 1.5 | mA            |
| $I_{CC(S)}$ | Shutdown current | STBY 1, STBY2, 5V_STBY = 0 V                                      |     | 0.001 | 10  | $\mu\text{A}$ |



# TPS5120-Q1

## DUAL OUTPUT, TWO-PHASE SYNCHRONOUS BUCK DC/DC CONTROLLER

SGLS225B – JANUARY 2004 – REVISED APRIL 2008

### TYPICAL CHARACTERISTICS

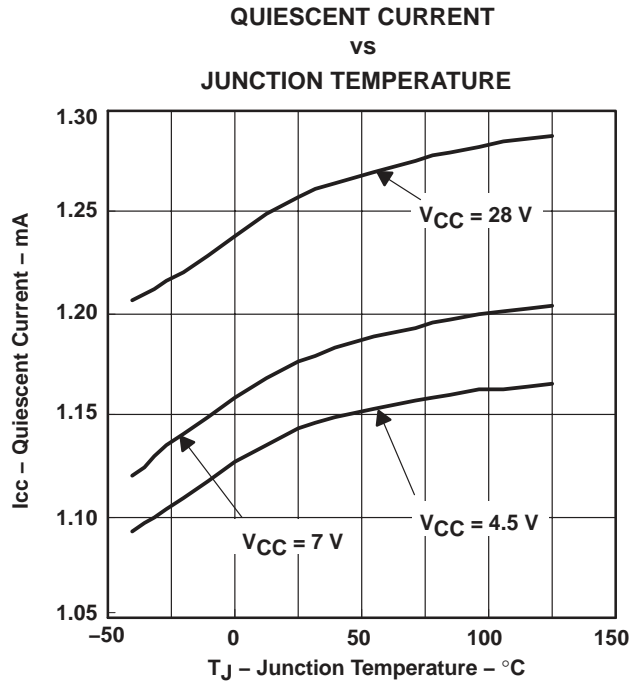

Figure 2

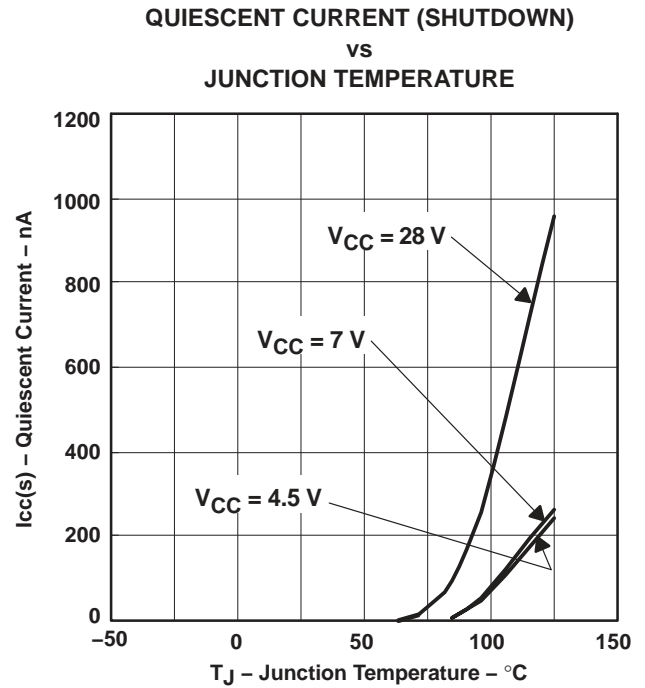

Figure 3

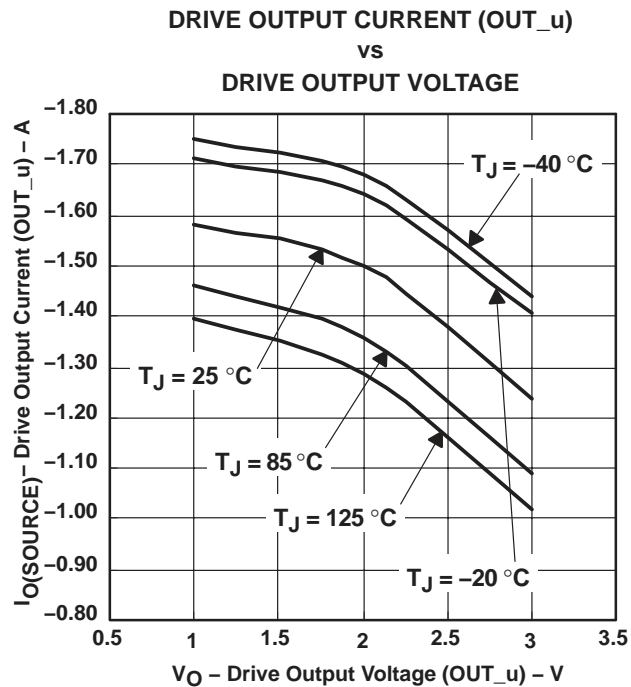

Figure 4

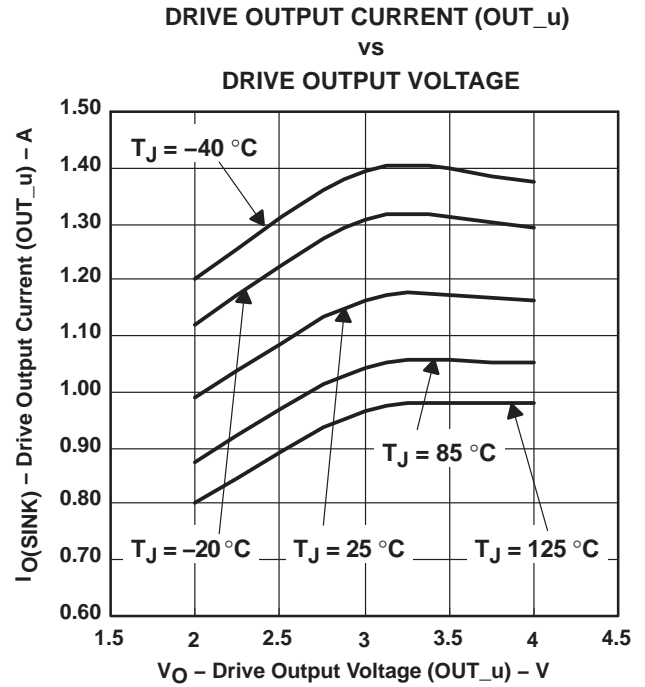

Figure 5

# TPS5120-Q1

## DUAL OUTPUT, TWO-PHASE SYNCHRONOUS BUCK DC/DC CONTROLLER

SGLS225B – JANUARY 2004 – REVISED APRIL 2008

### TYPICAL CHARACTERISTICS

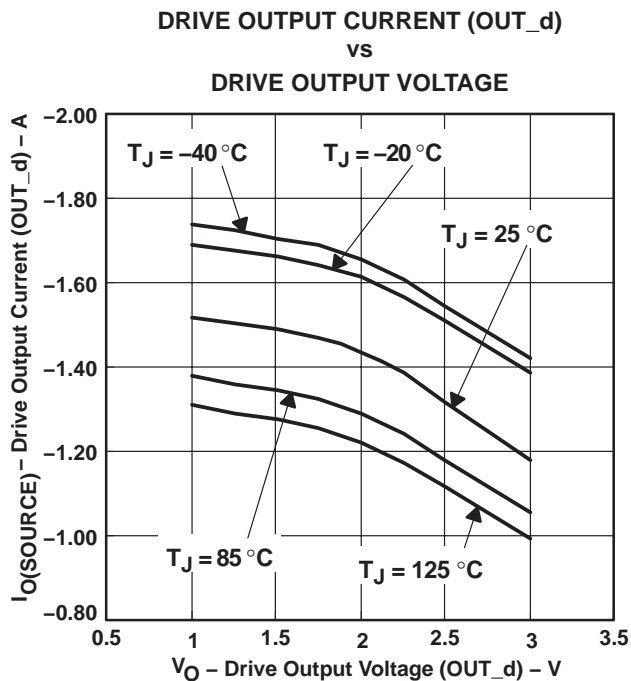

Figure 6

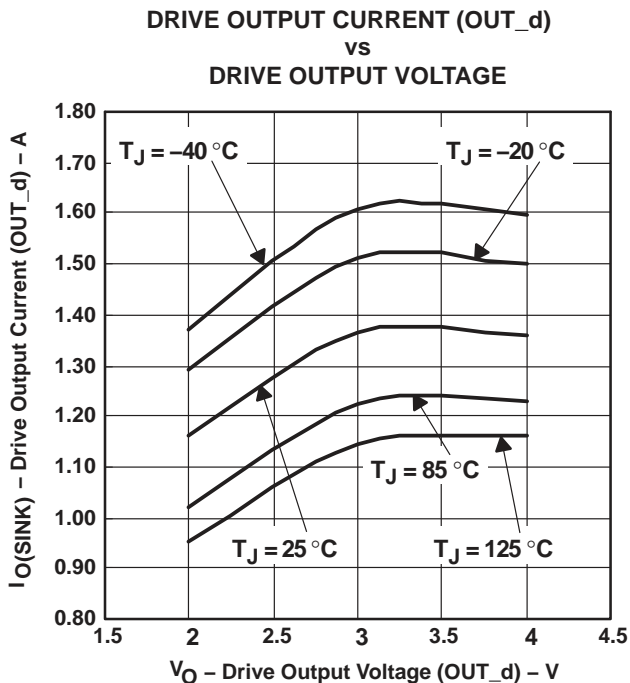

Figure 7

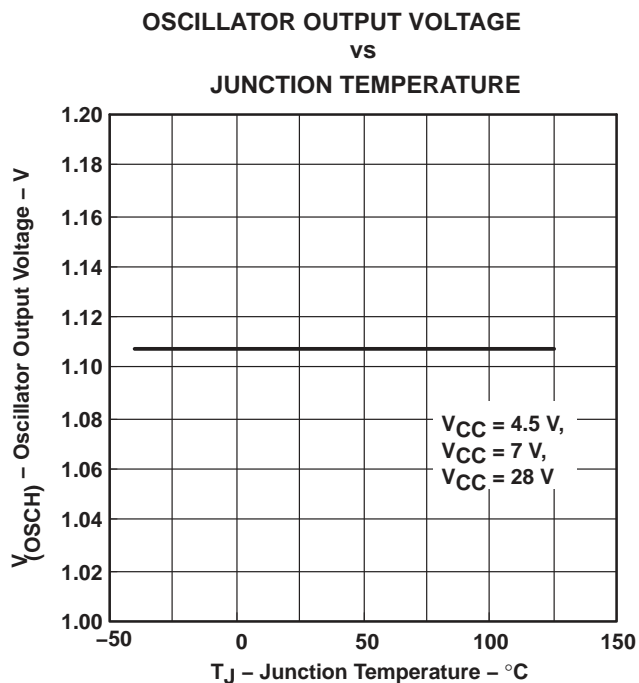

Figure 8

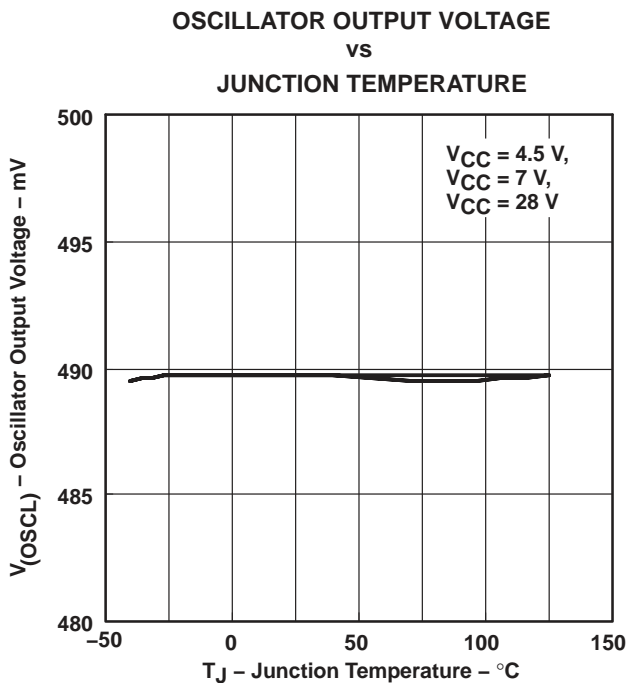

Figure 9



**TYPICAL CHARACTERISTICS**

**ERROR AMPLIFIER INPUT OFFSET VOLTAGE  
vs  
JUNCTION TEMPERATURE**

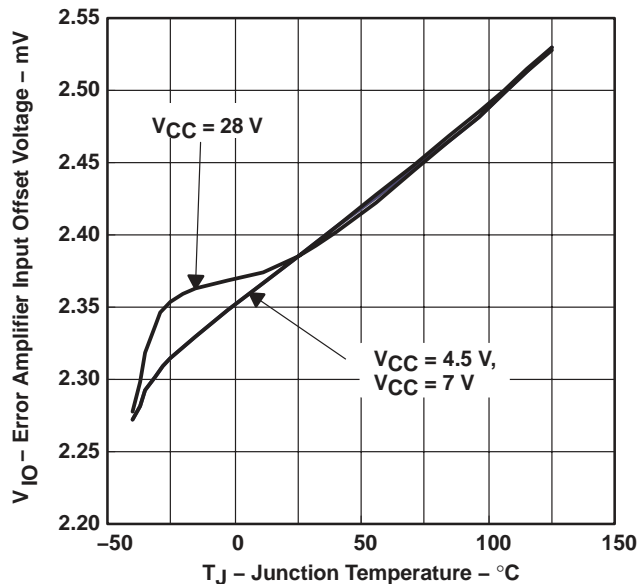

Figure 10

**ERROR AMPLIFIER OUTPUT VOLTAGE  
vs  
JUNCTION TEMPERATURE**

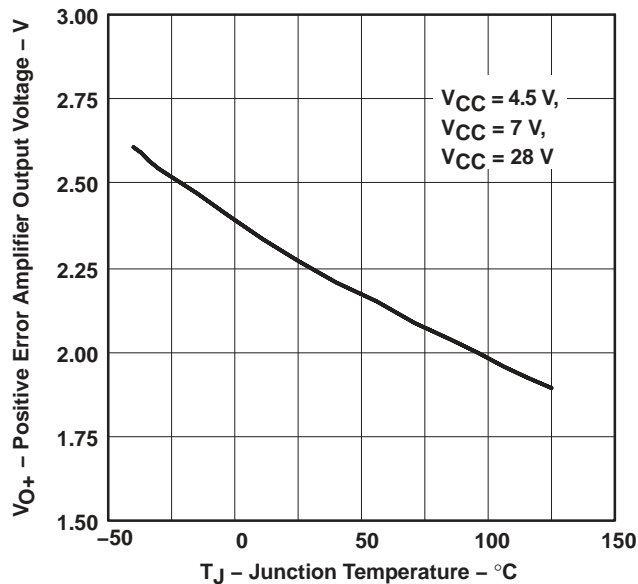

Figure 11

**ERROR AMPLIFIER OUTPUT VOLTAGE  
vs  
JUNCTION TEMPERATURE**

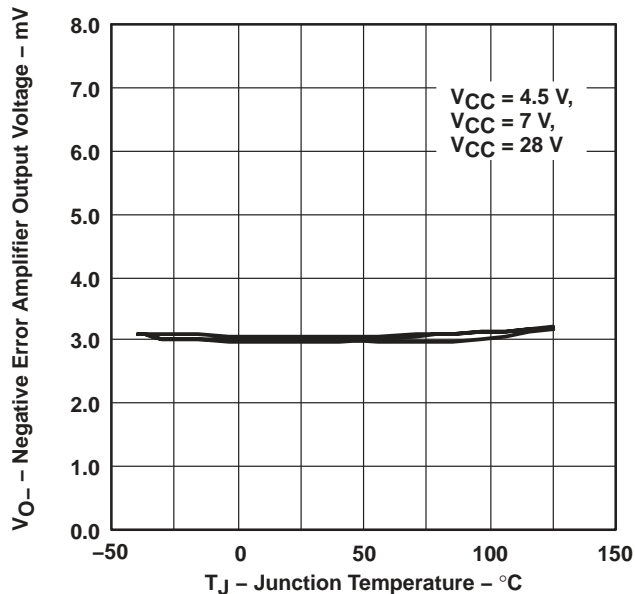

Figure 12

**SKIP COMPARATOR HYSTERESIS VOLTAGE  
vs  
JUNCTION TEMPERATURE**

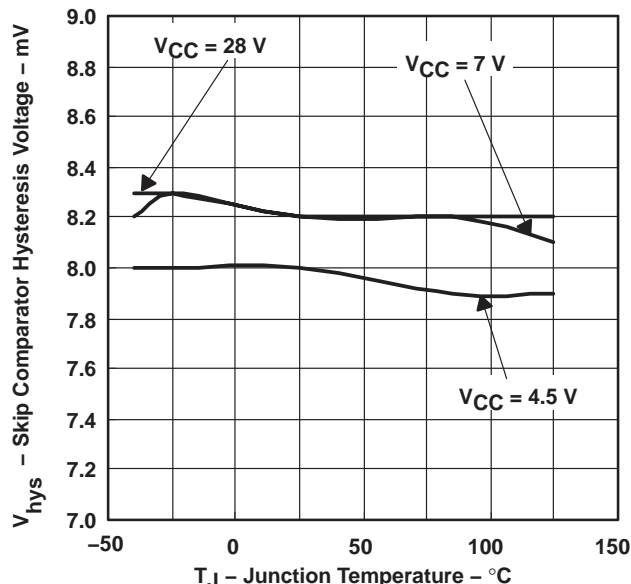

Figure 13

# TPS5120-Q1

## DUAL OUTPUT, TWO-PHASE SYNCHRONOUS BUCK DC/DC CONTROLLER

SGLS225B – JANUARY 2004 – REVISED APRIL 2008

### TYPICAL CHARACTERISTICS

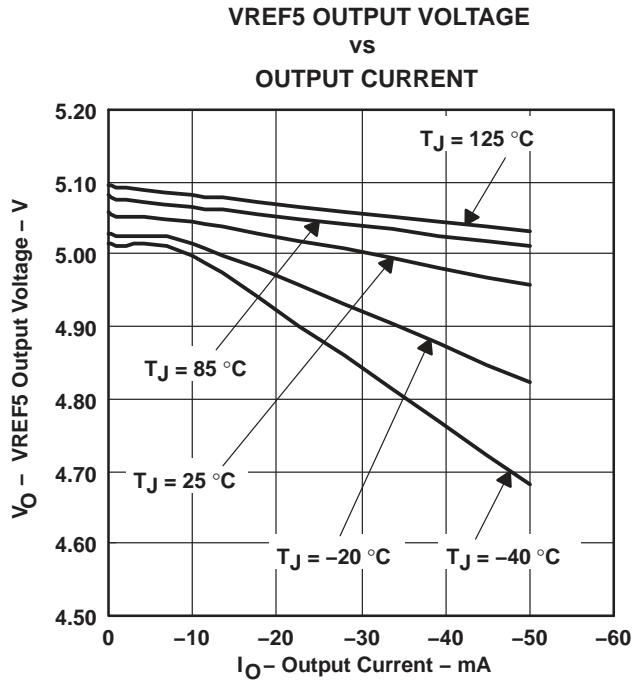

Figure 14

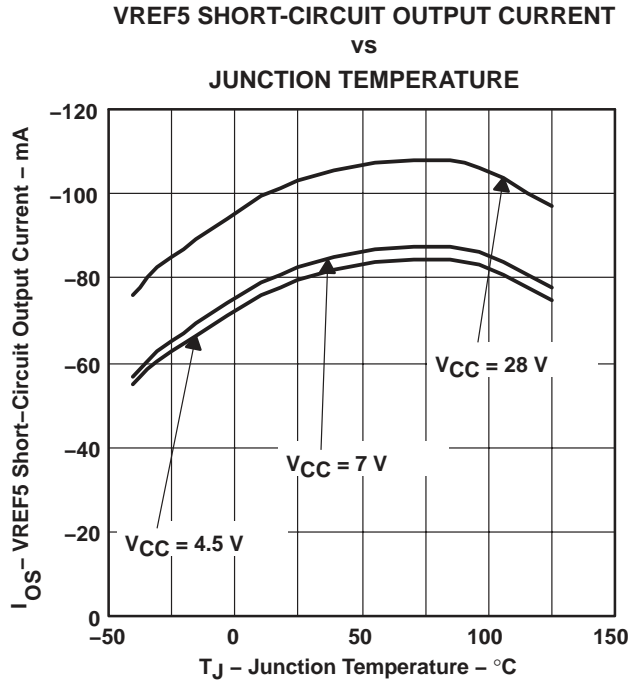

Figure 15

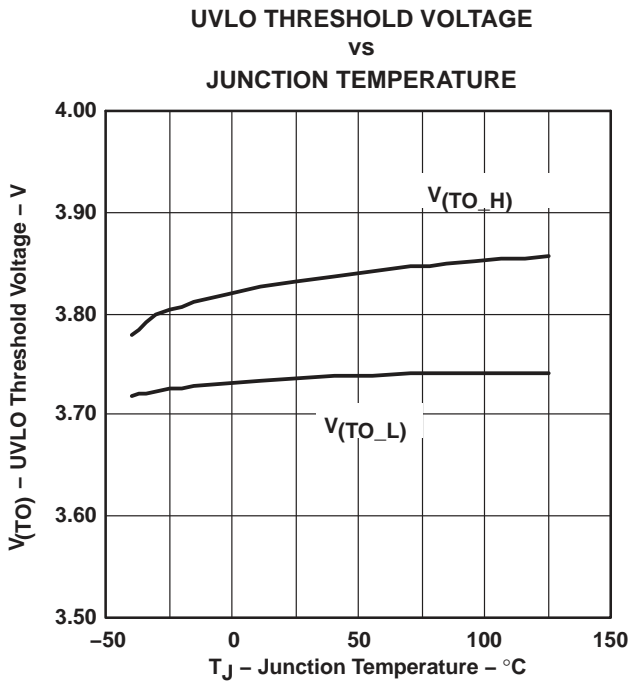

Figure 16

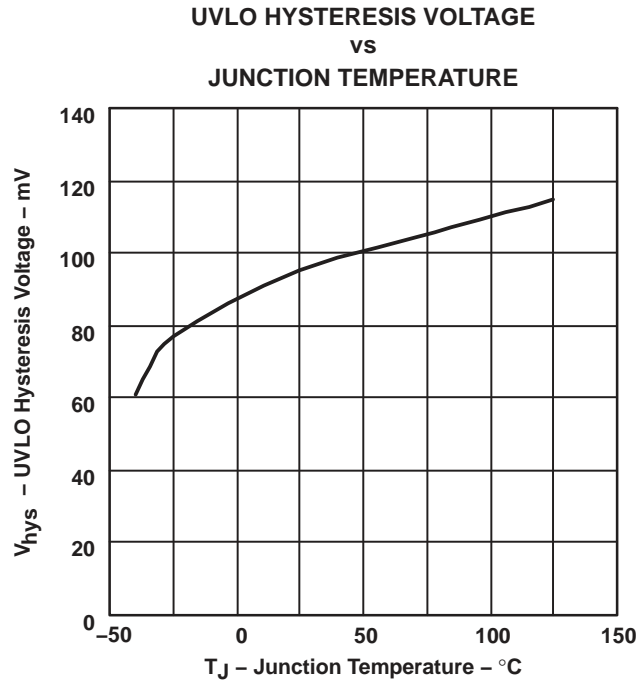
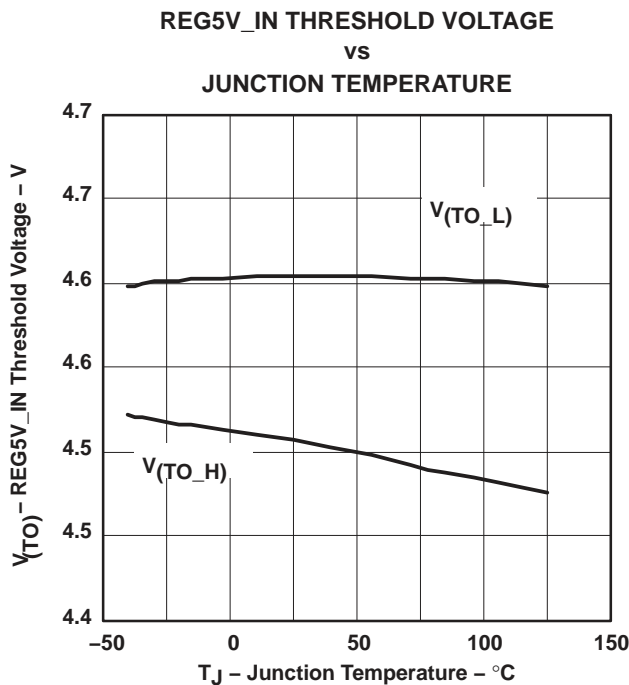

Figure 17



**TYPICAL CHARACTERISTICS**



**Figure 18**

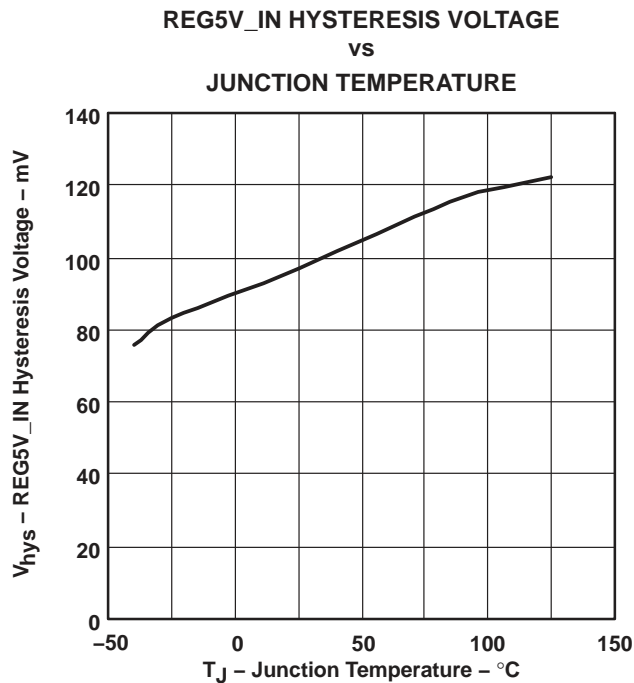

**Figure 19**

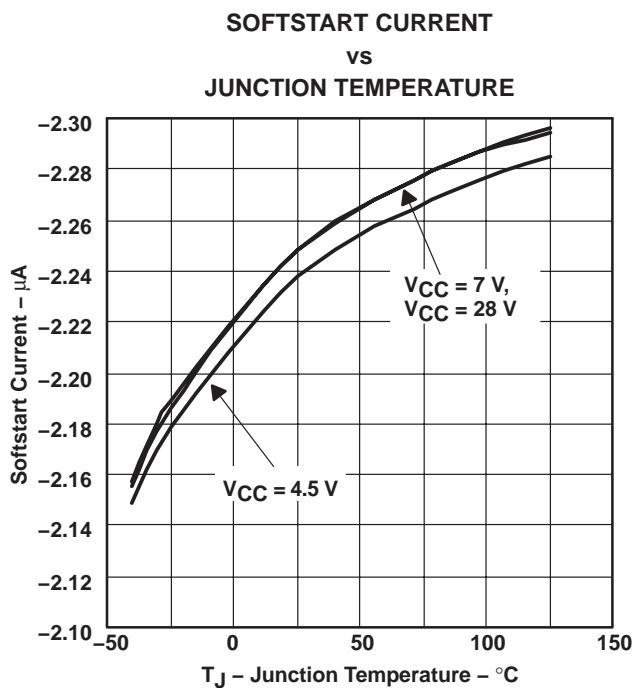

**Figure 20**

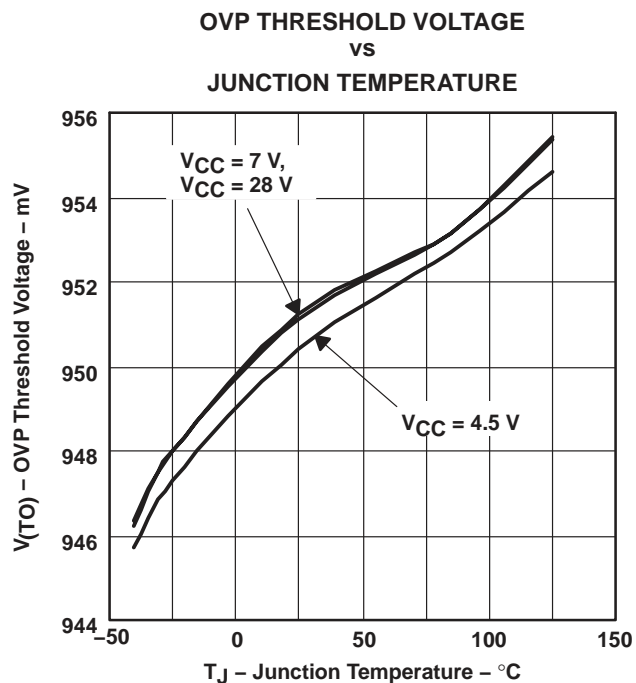

**Figure 21**

# TPS5120-Q1

## DUAL OUTPUT, TWO-PHASE SYNCHRONOUS BUCK DC/DC CONTROLLER

SGLS225B – JANUARY 2004 – REVISED APRIL 2008

### TYPICAL CHARACTERISTICS

**POWERGOOD THRESHOLD VOLTAGE**  
vs  
**JUNCTION TEMPERATURE**

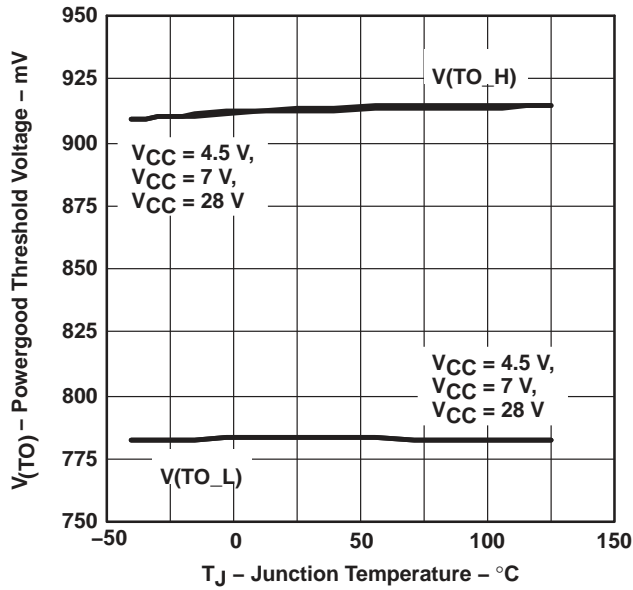

**Figure 22**

**SCP (OVP) SOURCE CURRENT**  
vs  
**JUNCTION TEMPERATURE**

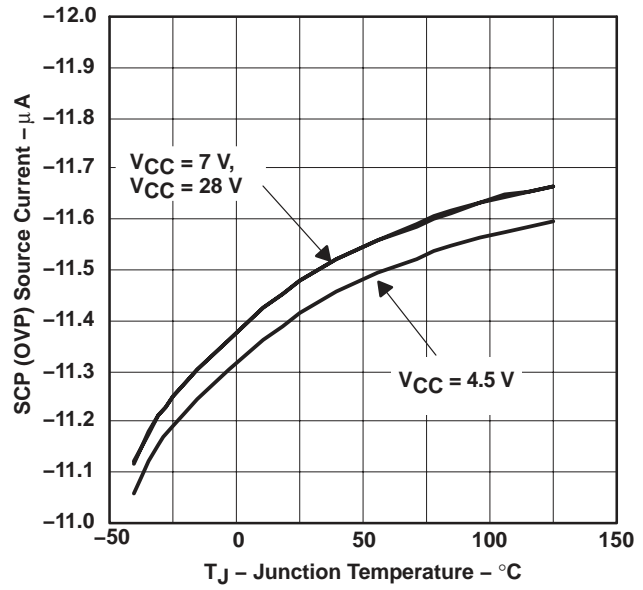

**Figure 23**

**SCP (OVP) SOURCE CURRENT**  
vs  
**JUNCTION TEMPERATURE**

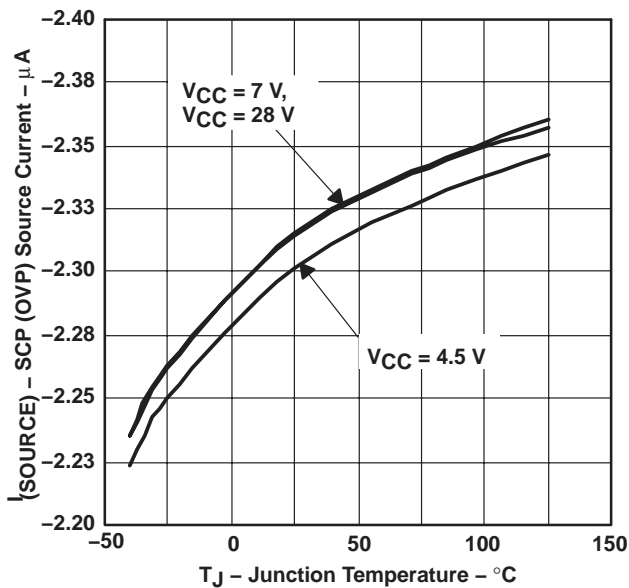

**Figure 24**

**TRIP SINK CURRENT**  
vs  
**TRIP INPUT VOLTAGE**

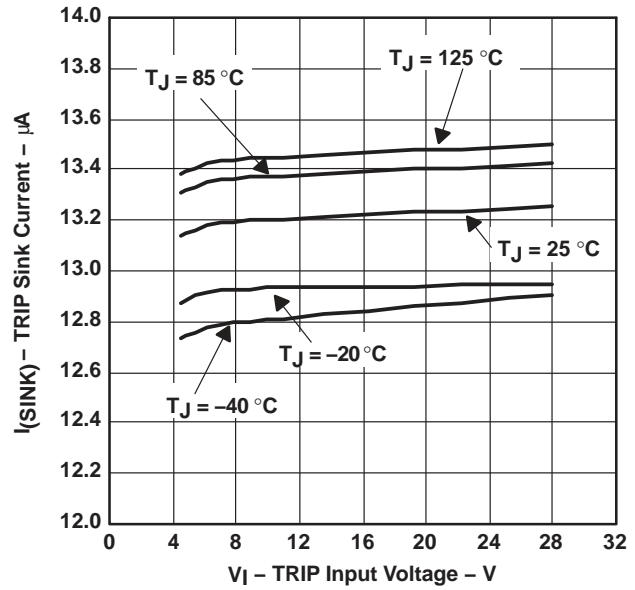

**Figure 25**





# TPS5120-Q1

## DUAL OUTPUT, TWO-PHASE SYNCHRONOUS BUCK DC/DC CONTROLLER

SGLS225B – JANUARY 2004 – REVISED APRIL 2008

### TYPICAL CHARACTERISTICS

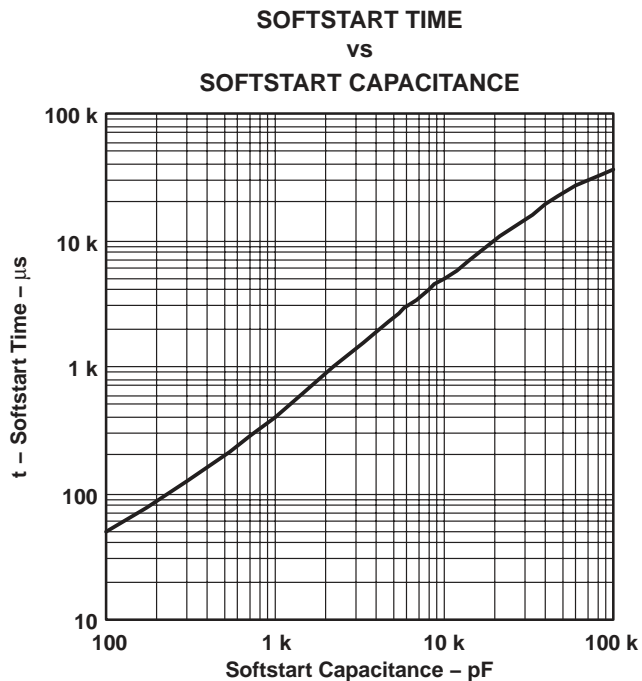
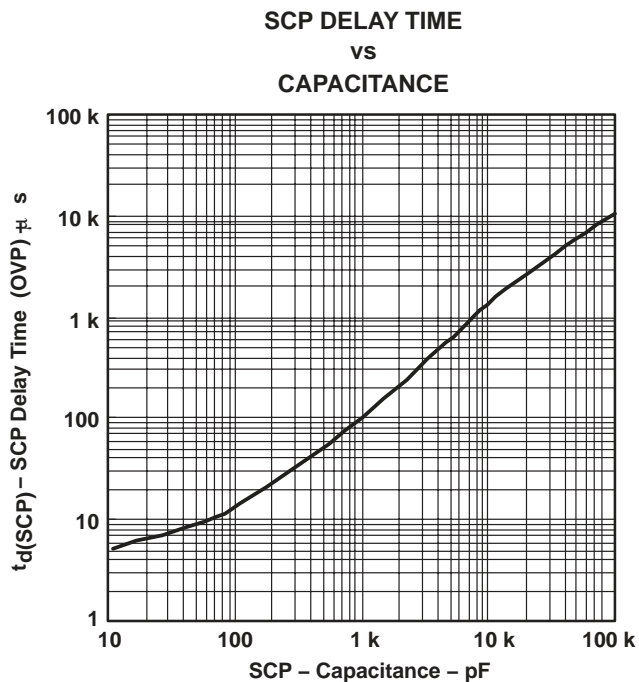
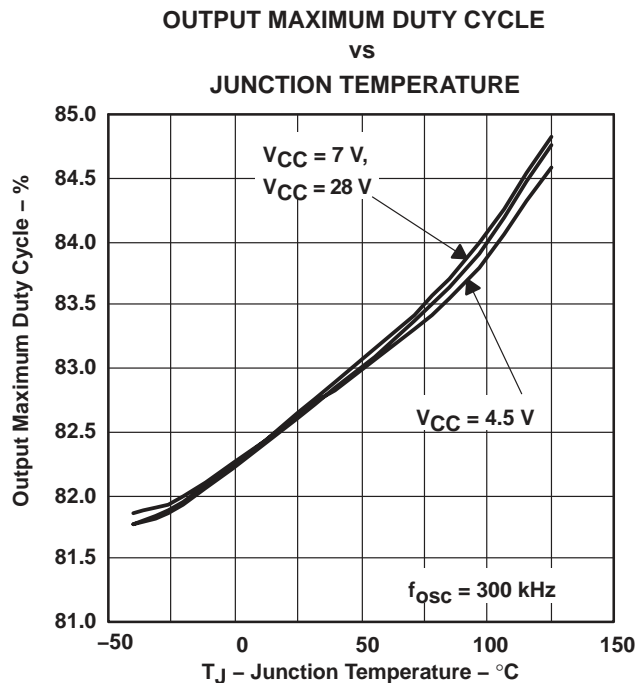
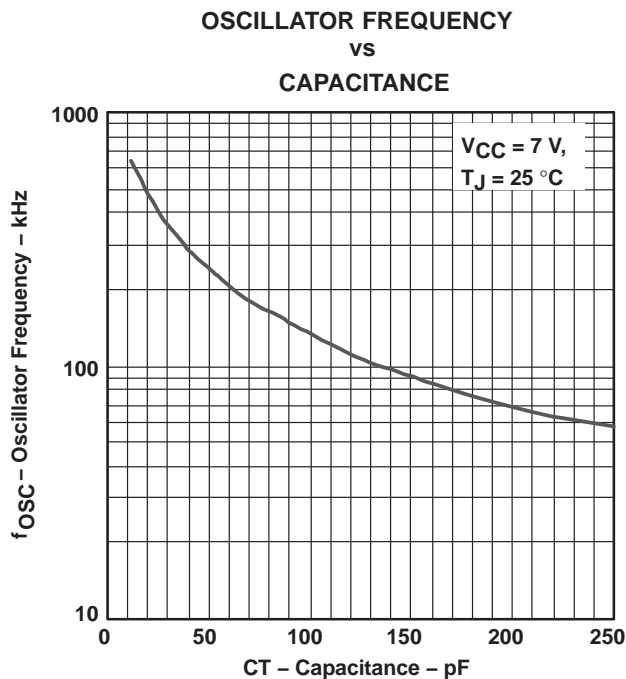

# TPS5120-Q1

## DUAL OUTPUT, TWO-PHASE SYNCHRONOUS BUCK DC/DC CONTROLLER

SGLS225B – JANUARY 2004 – REVISED APRIL 2008

### TYPICAL CHARACTERISTICS

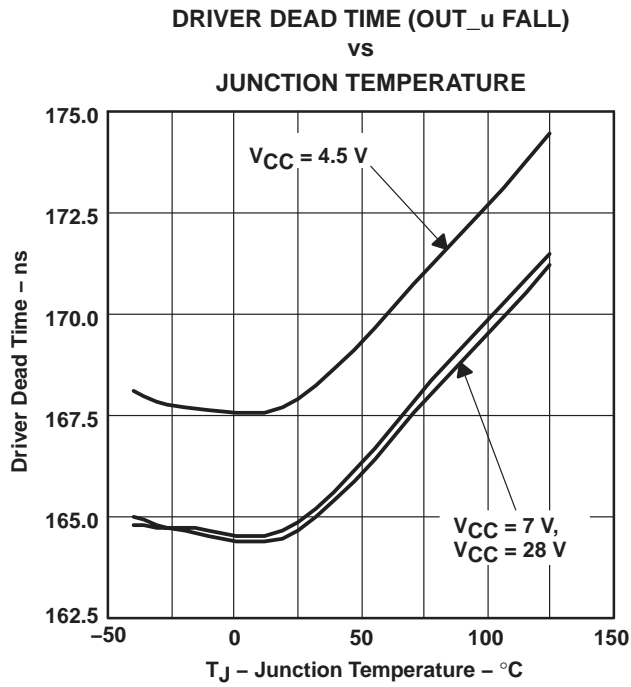

Figure 30

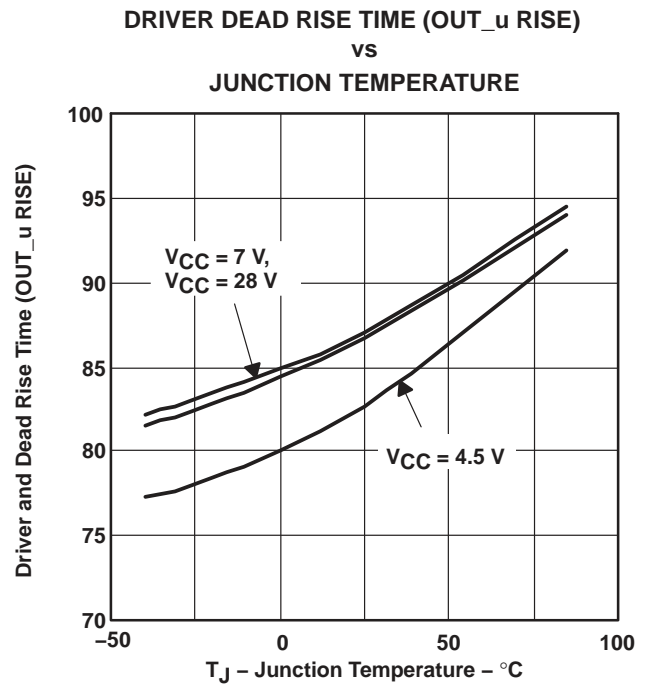

Figure 31

**PACKAGING INFORMATION**

| Orderable Device | Status<br>(1) | Package Type | Package Drawing | Pins | Package Qty | Eco Plan<br>(2) | Lead finish/<br>Ball material<br>(6) | MSL Peak Temp<br>(3) | Op Temp (°C) | Device Marking<br>(4/5) | Samples |
|------------------|---------------|--------------|-----------------|------|-------------|-----------------|--------------------------------------|----------------------|--------------|-------------------------|---------|
| TPS5120QDBTRQ1G4 | ACTIVE        | TSSOP        | DBT             | 30   | 2000        | RoHS & Green    | NIPDAU                               | Level-2-260C-1 YEAR  | -40 to 125   | TPS5120Q1               | Samples |

(1) The marketing status values are defined as follows:

**ACTIVE:** Product device recommended for new designs.

**LIFEBUY:** TI has announced that the device will be discontinued, and a lifetime-buy period is in effect.

**NRND:** Not recommended for new designs. Device is in production to support existing customers, but TI does not recommend using this part in a new design.

**PREVIEW:** Device has been announced but is not in production. Samples may or may not be available.

**OBSELETE:** TI has discontinued the production of the device.

(2) **RoHS:** TI defines "RoHS" to mean semiconductor products that are compliant with the current EU RoHS requirements for all 10 RoHS substances, including the requirement that RoHS substance do not exceed 0.1% by weight in homogeneous materials. Where designed to be soldered at high temperatures, "RoHS" products are suitable for use in specified lead-free processes. TI may reference these types of products as "Pb-Free".

**RoHS Exempt:** TI defines "RoHS Exempt" to mean products that contain lead but are compliant with EU RoHS pursuant to a specific EU RoHS exemption.

**Green:** TI defines "Green" to mean the content of Chlorine (Cl) and Bromine (Br) based flame retardants meet JS709B low halogen requirements of <=1000ppm threshold. Antimony trioxide based flame retardants must also meet the <=1000ppm threshold requirement.

(3) MSL, Peak Temp. - The Moisture Sensitivity Level rating according to the JEDEC industry standard classifications, and peak solder temperature.

(4) There may be additional marking, which relates to the logo, the lot trace code information, or the environmental category on the device.

(5) Multiple Device Markings will be inside parentheses. Only one Device Marking contained in parentheses and separated by a "-" will appear on a device. If a line is indented then it is a continuation of the previous line and the two combined represent the entire Device Marking for that device.

(6) Lead finish/Ball material - Orderable Devices may have multiple material finish options. Finish options are separated by a vertical ruled line. Lead finish/Ball material values may wrap to two lines if the finish value exceeds the maximum column width.

**Important Information and Disclaimer:**The information provided on this page represents TI's knowledge and belief as of the date that it is provided. TI bases its knowledge and belief on information provided by third parties, and makes no representation or warranty as to the accuracy of such information. Efforts are underway to better integrate information from third parties. TI has taken and continues to take reasonable steps to provide representative and accurate information but may not have conducted destructive testing or chemical analysis on incoming materials and chemicals. TI and TI suppliers consider certain information to be proprietary, and thus CAS numbers and other limited information may not be available for release.

In no event shall TI's liability arising out of such information exceed the total purchase price of the TI part(s) at issue in this document sold by TI to Customer on an annual basis.

**OTHER QUALIFIED VERSIONS OF TPS5120-Q1 :**

- Catalog : [TPS5120](#)
- Enhanced Product : [TPS5120-EP](#)

NOTE: Qualified Version Definitions:

- Catalog - TI's standard catalog product
- Enhanced Product - Supports Defense, Aerospace and Medical Applications

**TAPE AND REEL INFORMATION**

**QUADRANT ASSIGNMENTS FOR PIN 1 ORIENTATION IN TAPE**

\*All dimensions are nominal

| Device           | Package Type | Package Drawing | Pins | SPQ  | Reel Diameter (mm) | Reel Width W1 (mm) | A0 (mm) | B0 (mm) | K0 (mm) | P1 (mm) | W (mm) | Pin1 Quadrant |
|------------------|--------------|-----------------|------|------|--------------------|--------------------|---------|---------|---------|---------|--------|---------------|
| TPS5120QDBTRQ1G4 | TSSOP        | DBT             | 30   | 2000 | 330.0              | 16.4               | 6.95    | 8.3     | 1.6     | 8.0     | 16.0   | Q1            |

**TAPE AND REEL BOX DIMENSIONS**

\*All dimensions are nominal

| Device           | Package Type | Package Drawing | Pins | SPQ  | Length (mm) | Width (mm) | Height (mm) |
|------------------|--------------|-----------------|------|------|-------------|------------|-------------|
| TPS5120QDBTRQ1G4 | TSSOP        | DBT             | 30   | 2000 | 350.0       | 350.0      | 43.0        |

# PACKAGE OUTLINE

**DBT0030A**

**TSSOP - 1.2 mm max height**

SMALL OUTLINE PACKAGE

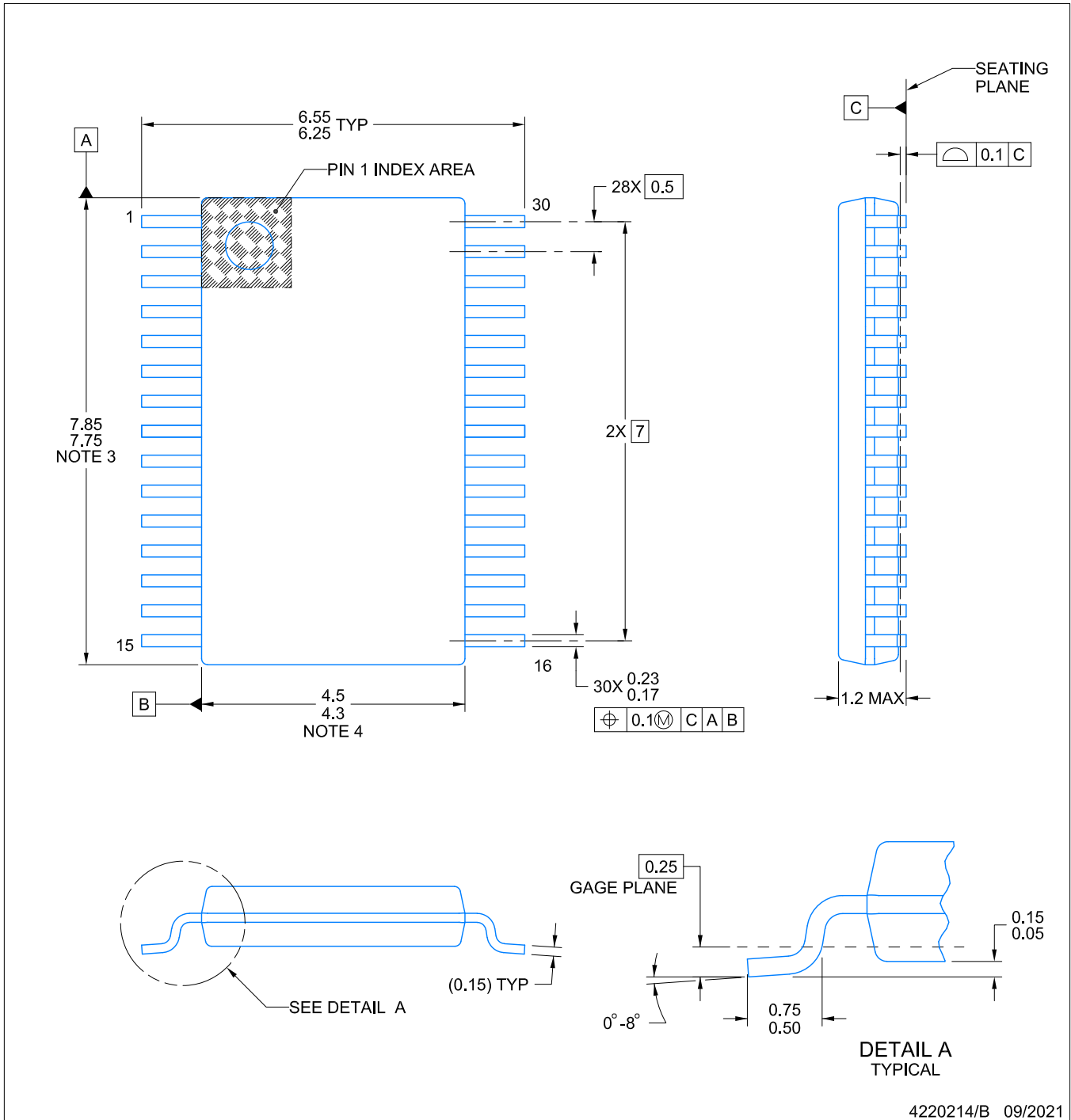

4220214/B 09/2021

**NOTES:**

1. All linear dimensions are in millimeters. Any dimensions in parenthesis are for reference only. Dimensioning and tolerancing per ASME Y14.5M.
2. This drawing is subject to change without notice.
3. This dimension does not include mold flash, protrusions, or gate burrs. Mold flash, protrusions, or gate burrs shall not exceed 0.15 mm per side.
4. This dimension does not include interlead flash. Interlead flash shall not exceed 0.25 mm per side.
5. Reference JEDEC registration MO-153.

# EXAMPLE BOARD LAYOUT

DBT0030A

TSSOP - 1.2 mm max height

SMALL OUTLINE PACKAGE

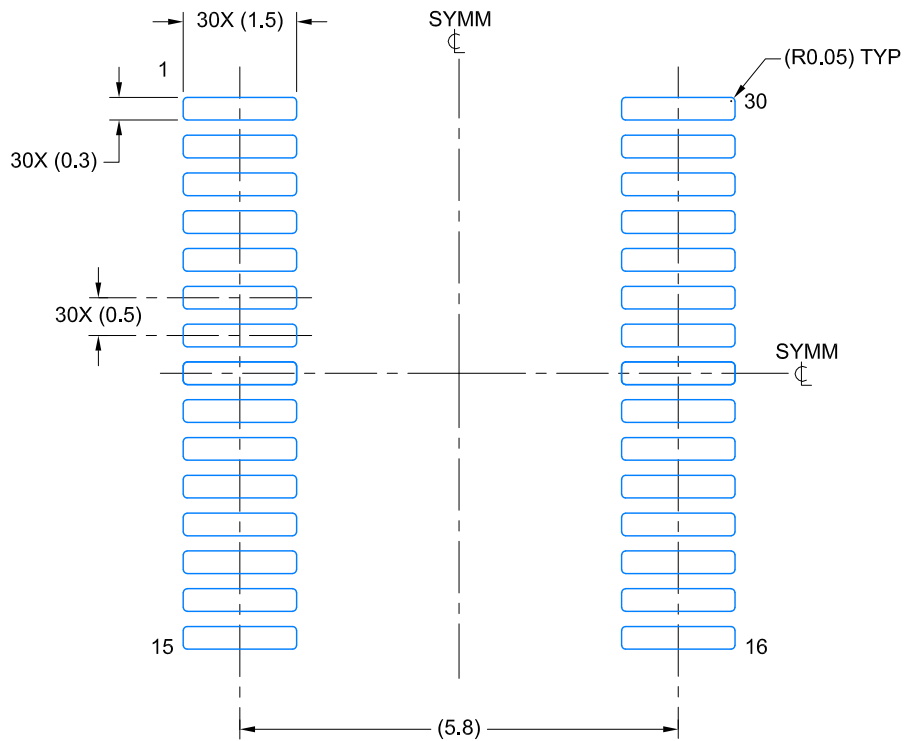

LAND PATTERN EXAMPLE  
EXPOSED METAL SHOWN  
SCALE: 10X

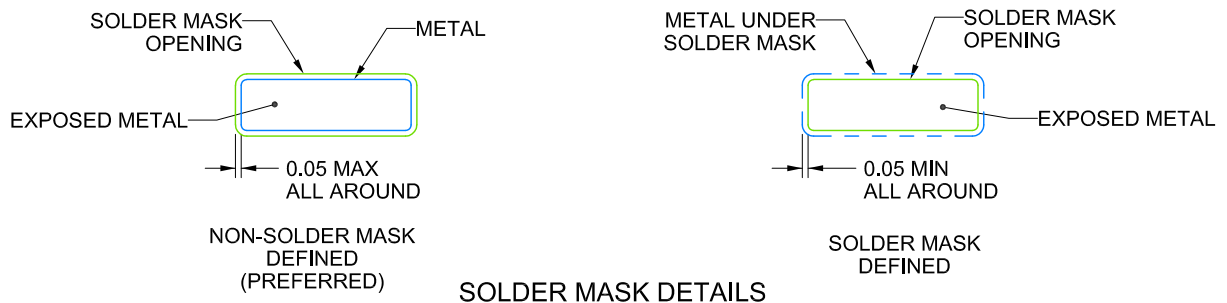

SOLDER MASK DETAILS

4220214/B 09/2021

NOTES: (continued)

6. Publication IPC-7351 may have alternate designs.

7. Solder mask tolerances between and around signal pads can vary based on board fabrication site.



# EXAMPLE STENCIL DESIGN

DBT0030A

TSSOP - 1.2 mm max height

SMALL OUTLINE PACKAGE

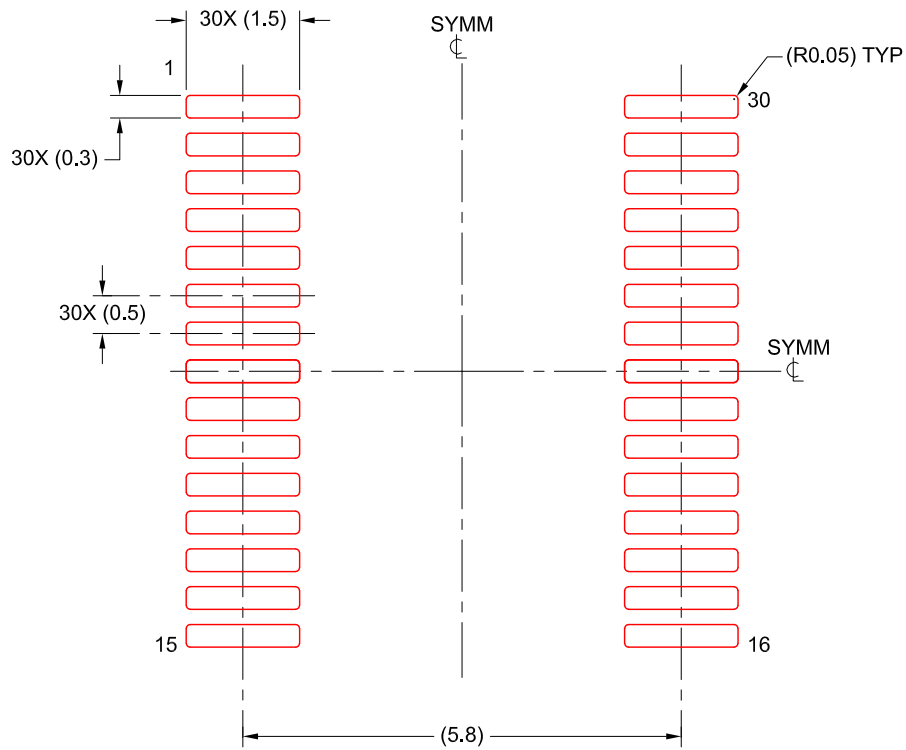

SOLDER PASTE EXAMPLE  
BASED ON 0.125 mm THICK STENCIL  
SCALE: 10X

4220214/B 09/2021

NOTES: (continued)

8. Laser cutting apertures with trapezoidal walls and rounded corners may offer better paste release. IPC-7525 may have alternate design recommendations.
9. Board assembly site may have different recommendations for stencil design.

## IMPORTANT NOTICE AND DISCLAIMER

TI PROVIDES TECHNICAL AND RELIABILITY DATA (INCLUDING DATA SHEETS), DESIGN RESOURCES (INCLUDING REFERENCE DESIGNS), APPLICATION OR OTHER DESIGN ADVICE, WEB TOOLS, SAFETY INFORMATION, AND OTHER RESOURCES "AS IS" AND WITH ALL FAULTS, AND DISCLAIMS ALL WARRANTIES, EXPRESS AND IMPLIED, INCLUDING WITHOUT LIMITATION ANY IMPLIED WARRANTIES OF MERCHANTABILITY, FITNESS FOR A PARTICULAR PURPOSE OR NON-INFRINGEMENT OF THIRD PARTY INTELLECTUAL PROPERTY RIGHTS.

These resources are intended for skilled developers designing with TI products. You are solely responsible for (1) selecting the appropriate TI products for your application, (2) designing, validating and testing your application, and (3) ensuring your application meets applicable standards, and any other safety, security, regulatory or other requirements.

These resources are subject to change without notice. TI grants you permission to use these resources only for development of an application that uses the TI products described in the resource. Other reproduction and display of these resources is prohibited. No license is granted to any other TI intellectual property right or to any third party intellectual property right. TI disclaims responsibility for, and you will fully indemnify TI and its representatives against, any claims, damages, costs, losses, and liabilities arising out of your use of these resources.

TI's products are provided subject to [TI's Terms of Sale](#) or other applicable terms available either on [ti.com](https://www.ti.com) or provided in conjunction with such TI products. TI's provision of these resources does not expand or otherwise alter TI's applicable warranties or warranty disclaimers for TI products.

TI objects to and rejects any additional or different terms you may have proposed.

Mailing Address: Texas Instruments, Post Office Box 655303, Dallas, Texas 75265  
Copyright © 2023, Texas Instruments Incorporated