

NOTES:

1. ROHS COMPLIANT
2. STORAGE TEMPERATURE: -50°C TO +125°C
3. COMPLIANCE TO J-STD:
 - A. J-STD-002: SOLDERABILITY AT 245°C REFLOW PROFILE
 - B. J-STD-020: LEVEL 1, NO MOISTURE SENSITIVE
 - C. J-STD-075: R7, 245°C MAXIMUM THROUGH REFLOW SOLDER
4. TO ORDER TAPE & REEL PACKAGING ADD A "T" SUFFIX TO THE PART NUMBER(i.e HX1112QNL BECOMES HX1112QNL T).

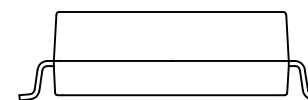
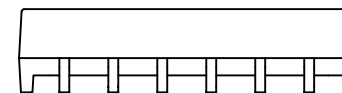
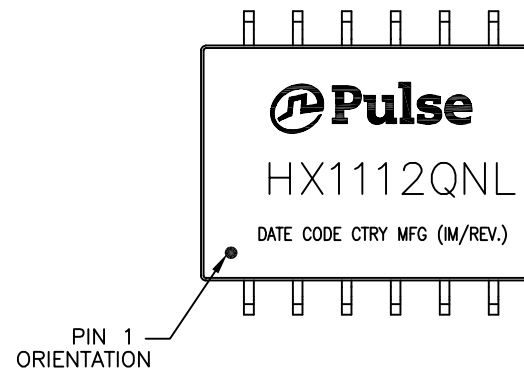

FINAL OUTLINE

© Copyright, 2015. Pulse Electronics Corp. All rights reserved. Pulse confidential & proprietary. (12/09/15)

| PRODUCT DESCRIPTION | TLA DRAWING | PS DRAWING | SHEET | PART NO. | DATASHEET REV. |
|------------------------|--------------|---------------|--------|-----------|----------------|
| MDL,SIN,100D,1:1,SM,TU | HX1112QNL-P1 | PS-0023.002-A | 1 OF 3 | HX1112QNL | A |

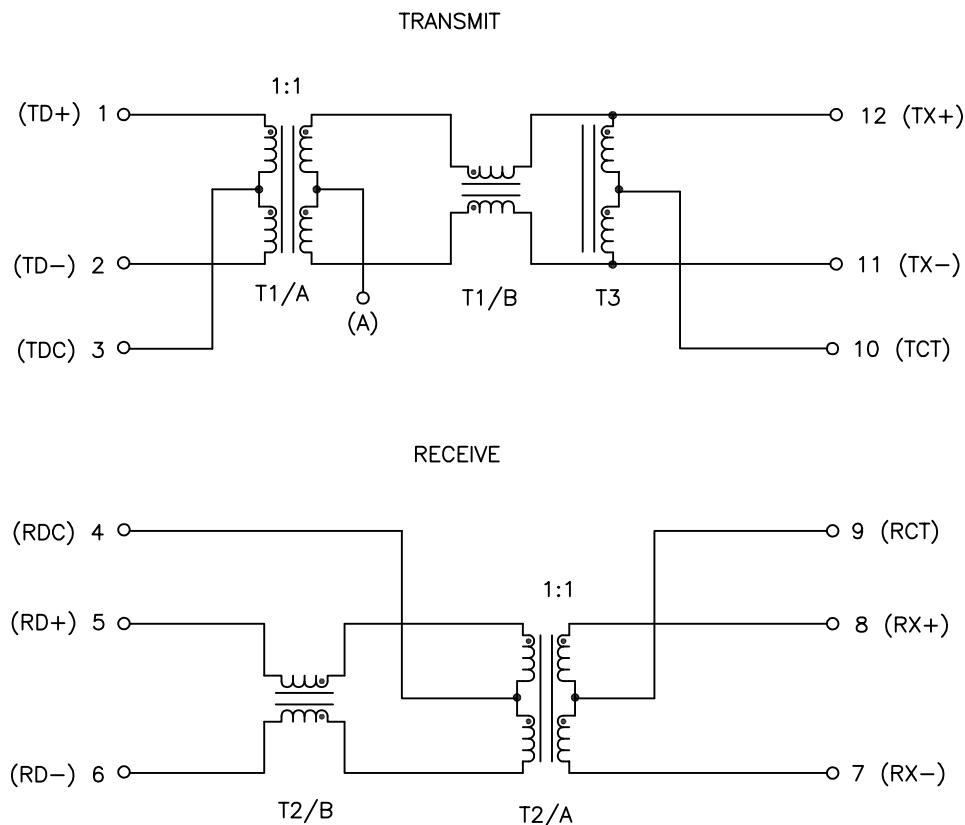

SCHEMATIC

ELECTRICAL CHARACTERISTICS AT +25°C UNLESS OTHER SPECIFIED
(FOR REFERENCE ONLY. USED FOR CUSTOMER INFORMATION.)

| PARAMETER | SPECIFICATIONS | | |
|--|--|--|--|
| OPERATION TEMP | -40°C ~ +85°C | | |
| TURNS RATIO | 1 : 1 ±2% | | |
| POLARITY | PER SCHEMATIC | | |
| INSERTION LOSS | 100 KHz | 1-100 MHz | 125 MHz |
| | -1.2 dB MAX | -1.0 dB MAX | -3.0 dB MAX |
| RETURN LOSS (Z OUT = 100 OHM ±15%) | .1-40 MHz | | 40-100 MHz |
| | -16 dB MIN | | -10+20*LOG ₁₀ (f/80 MHz) dB MIN |
| | -18 dB MIN (100 OHMs) | | |
| INDUCTANCE (OCL) (MEDIA SIDE, -40°C-85°C) | 350 uH MIN (MEASURED AT 100 KHz, 100 mVRMS) (AND WITH 8 mA DC BIAS) | | |
| CROSSTALK, ADJACENT CHANNELS | 1 MHz | 10-100 MHz | |
| | -50 dB MIN | -33+20*LOG ₁₀ (f/50) dB MIN | |
| COMMON MODE REJECTION RATIO | 0.1-100 MHz | | |
| | -30 dB MIN | | |
| DC RESISTANCE, 1/2 WINDING | .65 OHMS MAX | | |
| DC RESISTANCE IMBALANCE | ±.065 OHMS MAX (CENTER TAP SYMMETRY) | | |
| INPUT - OUTPUT ISOLATION | 1500 VRMS MIN @ 60 SECONDS | | |

NOTE: f IS FREQUENCY IN MHz.

© Copyright, 2015. Pulse Electronics Corp. All rights reserved. Pulse confidential & proprietary. (12/09/15)

| PRODUCT DESCRIPTION | TLA DRAWING | PS DRAWING | SHEET | PART NO. | DATASHEET REV. |
|------------------------|--------------|---------------|--------|-----------|----------------|
| MDL,SIN,100D,1:1,SM,TU | HX1112QNL-P1 | PS-0023.002-A | 2 OF 3 | HX1112QNL | A |

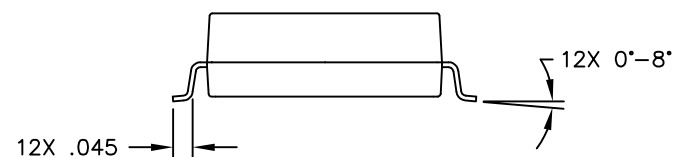
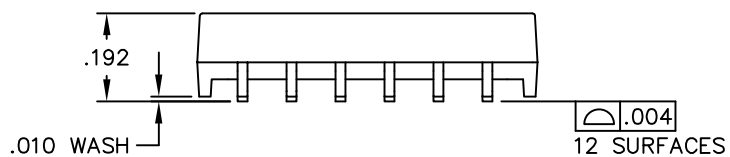
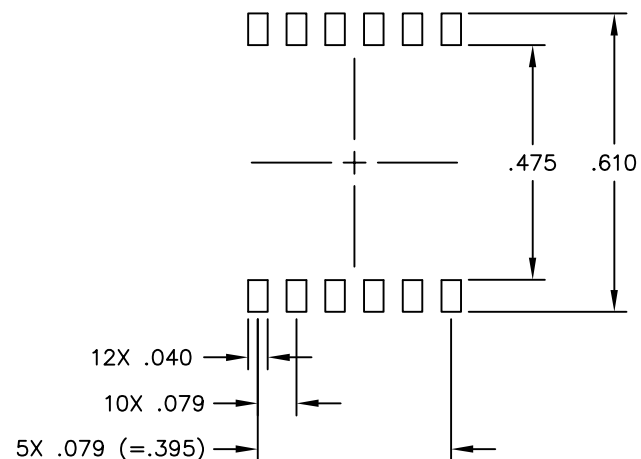
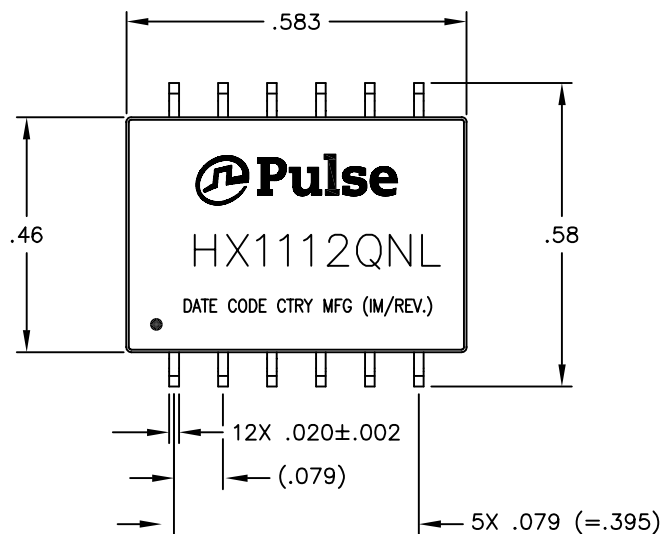

DIMENSIONS ARE IN INCHES WITH THE FOLLOWING
TOLERANCES:
.XX= ±.01
.XXX= ±.005

© Copyright, 2015. Pulse Electronics Corp. All rights reserved. Pulse confidential & proprietary. (12/09/15)

| PRODUCT DESCRIPTION | TLA DRAWING | PS DRAWING | SHEET | PART NO. | DATASHEET REV. |
|------------------------|--------------|---------------|--------|-----------|----------------|
| MDL,SIN,100D,1:1,SM,TU | HX1112QNL-P1 | PS-0023.002-A | 3 OF 3 | HX1112QNL | A |