



## ABSTRACT

TI's DLP® technology offers a fully programmable and high-resolution solution for automotive dynamic ground projection (DGP) applications. With nearly half a million addressable pixels per module using a WVGA (864 × 480) input resolution, DLP technology exceeds the resolution of existing ground projections technologies. Dynamic ground projection technology, with the ability to display any static or video pattern within the same module, can re-invent consumers' perceptions on small projector lighting by providing new, innovative lighting capabilities. Examples include automotive light “carpets” that can illuminate the surrounding area outside a vehicle or project vehicle information such as the EV charge level and range remaining, tire pressure warnings, traffic warnings, turn signaling, check engine light warning, gas level/range, etc. from a side mirror. Ground illumination has other enhancement features to help cars communicate with drivers and pedestrians, including corner lighting, reverse lighting, vehicle customization, and parking indicators.

The DLP3021LEQ1EVM is the DLP3021-Q1 Light Engine Evaluation Module (EVM) that allows for accelerated evaluation of the DLP3021-Q1 chipset with the inclusion of a DLP3021-Q1 light engine. This module brings together a set of components including the DLP3021-Q1 DMD, the FPGA based DMD controller, and the TPS65100 PMIC to provide an efficient system for evaluation of dynamic ground projection technology. When combined with a computer for GUI control, the evaluation module can be used in a laboratory setting to demonstrate features such as:

## Table of Contents

<b>1 Trademarks</b> .....	3
<b>2 DLP3021-Q1 Electronics EVM Overview</b> .....	4
2.1 Introduction.....	4
2.2 What is in the DLP3021-Q1 Light Engine EVM.....	4
2.3 Non-Optical Specifications.....	9
<b>3 Quick Start</b> .....	11
3.1 Kit Assembly Instructions.....	11
3.2 Software Installation.....	12
3.3 Power-Up.....	12
3.4 Select Display Content.....	12
3.5 LED Driver.....	13
<b>4 Optics and Mechanics</b> .....	15
<b>5 Software</b> .....	16
5.1 DLP Composer.....	16
5.2 DLP Control Program.....	23
5.3 MSP430 Example Code.....	26
<b>6 Revision History</b> .....	27

## List of Figures

Figure 2-1. DLP3021LEQ1EVM Block Diagram.....	5
Figure 2-2. DLP3021LEQ1EVM Unit.....	5
Figure 2-3. Operating Mode Switches: Electronics Board S1-A and S1-B Switches .....	6
Figure 2-4. Operating Mode Switches: SPI Adapter Board S1 and S2 Switches.....	6
Figure 2-5. Cables Included in DLP3021LEQ1EVM for FTDI.....	9
Figure 2-6. LED Driver Timing Specifications.....	10
Figure 3-1. Cable Connections.....	11
Figure 3-2. Assembled DLP3021-Q1 Light Engine EVM with FTDI.....	11
Figure 3-3. Host Mute Operating Mode LED Status.....	12
Figure 3-4. Successful FTDI Cable Connection Established in GUI.....	13

Figure 5-1. DLP Composer - Default Register Configuration.....	16
Figure 5-2. DLP Composer - Illumination.....	17
Figure 5-3. DLP Composer - Sequence Set.....	17
Figure 5-4. DLP Composer - Degamma Curves.....	18
Figure 5-5. DLP Composer - Image/Video.....	19
Figure 5-6. DLP Composer - Flash Blocks.....	20
Figure 5-7. DLP Composer - Flash Programming.....	22
Figure 5-8. Flash Programming Operating Mode LED Status.....	22
Figure 5-9. DLP Composer - Connections.....	23
Figure 5-10. DLP Control Program - Connection.....	24
Figure 5-11. DLP Control Program - Scripting.....	24
Figure 5-12. DLP Control Program - Scripting Reference.....	25
Figure 5-13. DLP Control Program - Registers.....	25
Figure 5-14. DLP Composer - Commands.....	26
Figure 5-15. MSP430G2553-Q1 Code Composer Example Project for DGP EVM.....	27

### List of Tables

Table 2-1. DLP3021LEQ1 EVM Operating Mode Switch Positions.....	7
Table 2-2. Light Engine Performance Specifications.....	8
Table 2-3. DLP3021LEQ1EVM Cables.....	8
Table 2-4. Electrical Specifications.....	9
Table 2-5. LED Driver Timing Specifications.....	10
Table 3-1. FTDI C232HM MPSSE Cable to SPI Adapter Board Connections.....	11
Table 3-2. LED PWM Drive Current Conversion Reference.....	14
Table 5-1. Top Level Flash Structure.....	20
Table 5-2. Flash Information Block.....	21

## 1 Trademarks

DLP is a registered trademark of Texas Instruments. All other trademarks are the property of their respective owners.

## 2 DLP3021-Q1 Electronics EVM Overview

This user's guide presents an overview of the DLP3021-Q1 electronics EVM, a general description of the main features and functions, and quick start procedure for out-of-box evaluation. TI recommends users to first read the *Dynamic Ground Projection Application Requirements (DLPA116)* and *DLP3021-Q1 Dynamic Ground Projection System Design (DLPA086)* reports to become familiar with the terminology, variables, application considerations, and system design requirements for dynamic ground projection as they relate to the DLP3021-Q1 chipset.

### 2.1 Introduction

The DLP3021LEQ1EVM Evaluation Module (EVM) is a complete electronic and optical subsystem designed to control and interface with the DLP3021-Q1 chipset. The DLP3021-Q1 interfaces with an FPGA based DMD controller. This chipset is combined with illumination and projection optics, and RGB LEDs to create a projector that offers brightness of up to 30 lumens with full motion video playback in a small volume form factor. The DLP3021LEQ1EVM is not a production design, and is intended for evaluation only.

### 2.2 What is in the DLP3021-Q1 Light Engine EVM

The DLP3021-Q1 Light Engine EVM consists of three subsystems and two boards:

- DLP3021LEQ1EVM board:
  - Formatter — Includes the DLP3021-Q1 DMD, FPGA based DMD controller, the MSP430G2553 MCU, external flash memory, and the TPS65100-Q1 PMIC.
  - Illumination Driver — Includes illumination drivers and FETs.
  - Light Engine — Compact light engine designed to display images from the formatter.
- FTDI C232HM-DDHSL-0 USB to MPSSE serial cable for 3.3V logical level SPI communication with the FPGA based DMD controller and external flash memory. The Cheetah™ USB-to-SPI interface can be used as a faster alternative for USB-to-SPI communication, but must be purchased separately.
- SPI Adapter board — intermediate board between the FTDI USB-to-SPI cable and DLP3021LEQ1EVM electronics board required for *Host Mute* and *Flash Programming* operating modes. Includes toggle switches to change the operating mode of the EVM.

Figure 2-1 shows the block diagram of the DLP3021LEQ1EVM.

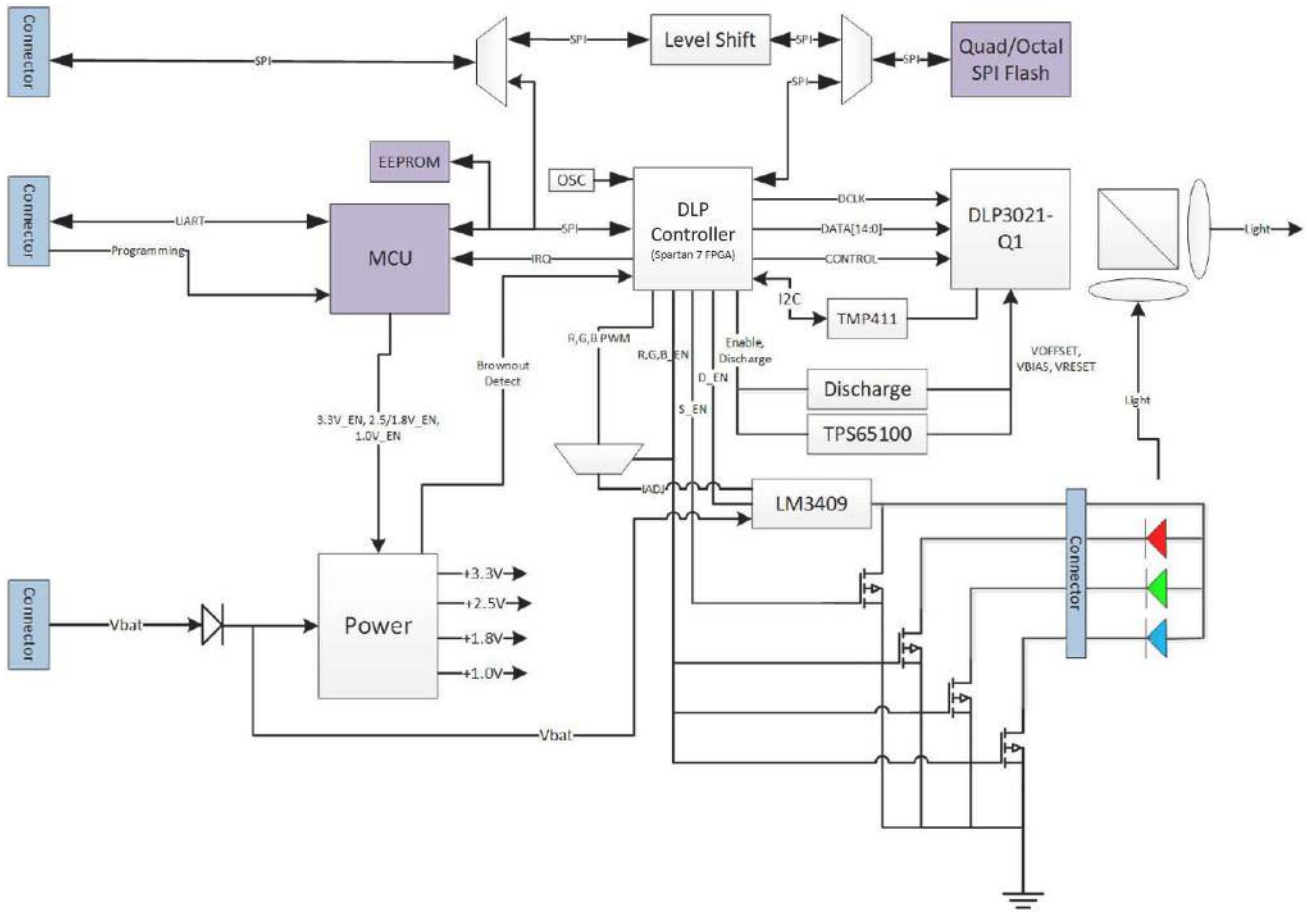



**Figure 2-1. DLP3021LEQ1EVM Block Diagram**

Figure 2-2 shows the assembled DLP3021LEQ1EVM Unit.



**Figure 2-2. DLP3021LEQ1EVM Unit**

<p style="text-align: center;"><b>CAUTION</b></p> <p>Projection Lamp May be harmful to the eyes. Do not stare at the operating lamp.</p> 	<p style="text-align: center;"><b>CAUTION</b></p> <p>Hot Surface Contact may cause burns. Do not touch.</p> 
--	--

### 2.2.1 Formatter Subsystem

The formatter subsystem converts and translates image/video data stored in external flash memory through the FPGA based DMD controller into the Double Data Rate (DDR) interface format compatible with the DLP3021-Q1 data bus. The EVM offers two operating modes to specify what and how the image/video content is to be displayed: in a closed-loop stand-alone mode using the on-board MSP430 MCU, or through an external controller (such as the FTDI USB-to-SPI cable or Cheetah™ SPI Host Adapter) for GUI operation.

A DIP two-position switch at S1 on the DLP3021L1Q1EVM allows the user to physically set the operating mode of the formatter subsystem. The SPI Adapter board also has two physical switches (S1 and S2) to set the same operating modes. [Figure 2-3](#) and [Figure 2-4](#) show the default S1 switch state for *Host Control* operating mode for stand-alone operation, and the default switch state for *Host Mute* operating mode when the SPI Adapter Board is connected.

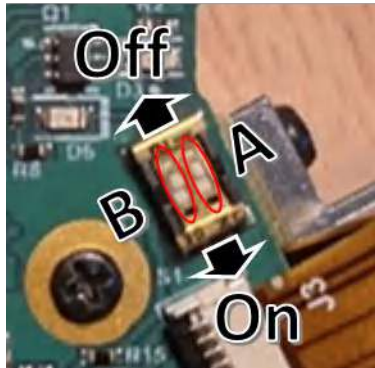

**Figure 2-3. Operating Mode Switches: Electronics Board S1-A and S1-B Switches**

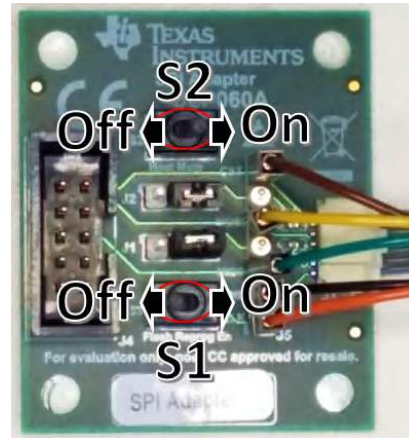

**Figure 2-4. Operating Mode Switches: SPI Adapter Board S1 and S2 Switches**

See [Table 2-1](#) for the switch positions required of each operating mode.

**Table 2-1. DLP3021LEQ1 EVM Operating Mode Switch Positions**

Operating Mode	DLP3021LEQ1EVM		SPI Adapter Board		LED State
	S1-A	S1-B	S1	S2	
Host Mute	Off	On	Off	On	Blue=ON, Amber=OFF, Green=ON
Local Host Control	Off	Off	Off	Off	Blue=OFF, Amber=OFF, Green=ON
FPGA Programming	On	On	On	On	Blue=ON, Amber=ON, Green=ON
Undefined	On	Off	On	Off	Blue=OFF, Amber=ON, Green=OFF

A brief description of each operating mode is provided as follows:

**Host Mute:** This mode allows direct read/writes to the DMD controller parameters. This is the recommended operation mode of the EVM for initial development and debug purposes. The FTDI cable and SPI Adapter board are required to run the EVM in this mode and bypass the MSP430G2553-Q1 MCU on-board host controller. The DLP Control Program is the GUI used to configure the DMD control parameters in this mode.

**Local Host Control:** This mode allows the MSP430G2553-Q1 MCU on-board host controller to locally read/write to the DMD controller. No additional hardware or GUI is required to run the EVM in this mode because command execution by the MCU automatically starts after the EVM is powered-up. This mode is recommended for demonstration purposes or system testing to emulate the end-product module. The SPI Adapter board and FTDI cable are not required for this operation mode.

**FPGA Programming:** This mode allows the DMD controller to be reprogrammed using the DLP Composer GUI. The FTDI cable and SPI Adapter board are required to run the EVM in this mode because the flash program binary is uploaded from the PC to EVM through the FTDI cable. The light engine will be disabled so that no content is displayed while the EVM is in this mode. See [Section 5.1.7](#) for details on Flash Programming.

**Undefined:** This mode is unsupported by the EVM and should not be used.

To allow the SPI Adapter board to set the operating mode, TI recommends the DLP3021LEQ1EVM electronics board S1 switches always be set to *Local Host Control* mode. This is because the On-state of either board will always override the Off-state of the other board. This setup will enable the use the more easily accessible S1 and S2 toggle switches of the SPI Adapter board to set the operating modes. When the SPI Adapter board is detached, the EVM will automatically start-up in the Local Host Control mode to allow the MSP430 to configure and run the EVM without intervention from an external controller such as the FTDI cable. When switching between operating modes, TI recommends that the EVM be fully power cycled to reset and apply the most recently set operating mode.

### 2.2.2 Illumination Subsystem

The illumination subsystem includes the LED driver circuit and RGB LEDs. The FPGA has three PWM outputs which typically correspond to red, green, and blue illumination colors. The PWM duty cycles can be adjusted to set a reference voltage to an external illumination driver circuit as needed to balance colors and adjust output brightness. Typical illumination configurations for the DLP3021Q1EVM:

- Optimal Color: PWM=450 with duty cycles of Red=30%, Green=45%, Blue=25%
- High Brightness: PWM=450 with duty cycles of Red=24.9%, Green=62.4%, Blue=12.7%

The PWM is a 10-bit value that is initialized to the Default Register Configuration value of DLP Composer, but can be modified in real-time during display operation. The duty cycle of each RGB can only be configured in DLP Composer as part of a list of Sequence Settings.

### 2.2.3 Light Engine

The light engine included with the DLP3021LEQ1EVM can expect to achieve the specifications listed in [Table 2-2](#).

**Table 2-2. Light Engine Performance Specifications**

PARAMETER		MIN	NOM	MAX	UNIT
Peak Lux at 1.76 m (measured at center of image)	Optimal Color <sup>1</sup>	White		135	Lux
		Black		0.35	
	High Brightness <sup>2</sup>	White		178	
		Black		0.47	
Full On/Full Off Contrast (average)	Optimal Color <sup>1</sup>		233		
	High Brightness <sup>2</sup>		286		
Field of View (FOV), Horizontal × Vertical			18.3 × 10.4		Degrees
<sup>1</sup> : LED PWM=1023; duty cycles: R34%, G40.8%, B25.2% <sup>2</sup> : LED PWM=1023; duty cycles: R24.9%, G62.4%, B12.7%					

### 2.2.4 Cables

The DLP3021LEQ1EVM kit contains the following cables shown in [Figure 2-5](#).

**Table 2-3. DLP3021LEQ1EVM Cables**

NAME	REFERENCE	QUANTITY
FTDI USB-to-SPI Cable	A	1
Host SPI Adapter Cable	B	1
Input Power Cable	C	1
DMD Signal Flex PCB Cable <sup>(1)</sup>	D	1
LED Driver Flex PCB Cable <sup>(1)</sup>	E	1
Cheetah™ SPI Host Adapter <sup>(2)</sup>	F	0
USB Type-A to Type-B Cable for Cheetah™ <sup>(2)</sup>	G	0
MSP-FET MSP MCU Programmer and Debugger <sup>(2)</sup>	H	0
<sup>(1)</sup> = Connected locally at DLP3021LEQ1EVM board <sup>(2)</sup> = Sold separately and not required for evaluation.		



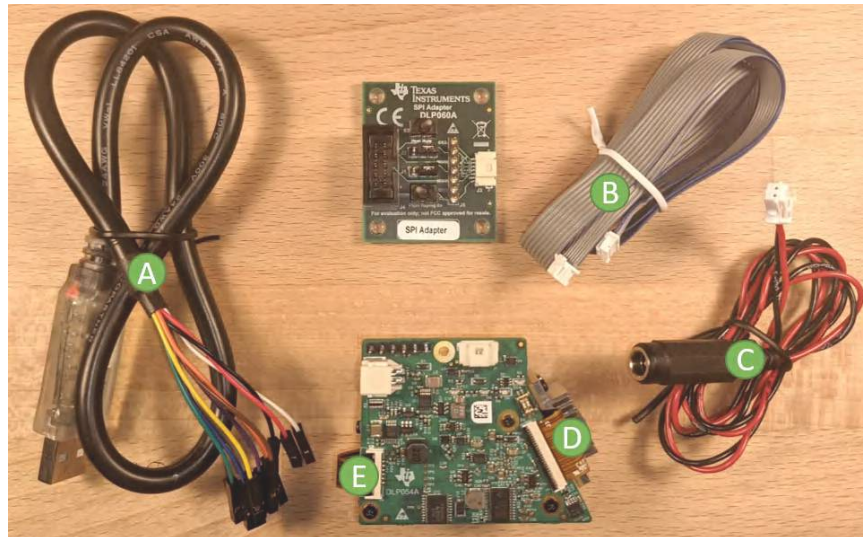

Figure 2-5. Cables Included in DLP3021LEQ1EVM for FTDI

## 2.3 Non-Optical Specifications

### 2.3.1 Electrical Specifications

Table 2-4. Electrical Specifications

PARAMETER	MIN	NOM	MAX	UNIT
<b>INPUT</b>				
Voltage	10.5	12	18	V
Power (PWM Enabled)		2.64		W
Power (PWM Disabled)		0.96		W
<b>LED DRIVER OUTPUT TO LOAD</b>				
Voltage (Per LED Channel)		3.3 <sup>(2)</sup>		V
Current (Per LED Channel)		0.5 <sup>(2)</sup>	1.2 <sup>(1)</sup>	A
Power (Sum of All LED Channels)		1.65 <sup>(2)</sup>		W
<b>TEMPERATURE</b>				
Operating DMD Temperature	-40		105 <sup>(3)</sup>	°C
<sup>(1)</sup> : Though the LED driver of the EVM is capable of driving above 1 A per channel, TI does not recommend driving beyond 500 mA for extended periods to prevent damage to the EVM due to individual component temperature ratings and thermal management limitations. <sup>(2)</sup> : Values based on DLP3021LEQ1EVM LED Part Numbers at 500-mA driver: <ul style="list-style-type: none"> <li>• Green: Osram LCG H9RM-LXMX-1</li> <li>• Red and Blue: Osram LE BR Q7WM-TGTI-24+JXJZ-23</li> </ul> <sup>(3)</sup> : Some components are only rated to 85°C.				

### 2.3.2 Component Temperature Ratings

The board and most of the board components are rated to operate between -40°C to 105°C, including the DLP3021-Q1, MSP430 MCU, and FPGA DMD controller. Some components on board, such as switches, connectors, and indicator LEDs, do not meet this temperature rating. Please refer to the EVM bill of materials to review the temperature specifications of all components used in the EVM design.

### 2.3.3 LED Driver Design

The DLP3021-Q1 chipset, used with LED illumination, includes illumination modulation based on the LM3904-Q1 P-FET buck controller for high-power LEDs. This illumination modulation turns off the light output

during micromirror reset, which improves system contrast. For the system timing specifications of the DLP3021LEQ1EVM, see [Figure 2-6](#).

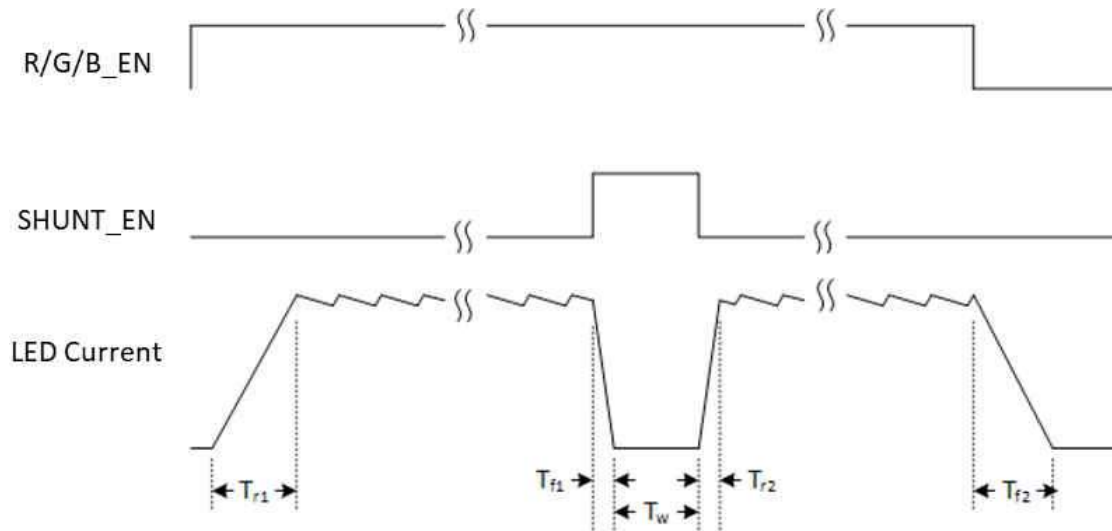

**Figure 2-6. LED Driver Timing Specifications**

The timing specifications are shown in [Table 2-5](#).

**Table 2-5. LED Driver Timing Specifications**

PARAMETER	VALUE
$T_{r1}, T_{f2}$	$< 50 \mu\text{s}$
$T_{f1}, T_{r2}$	$< 2 \mu\text{s}$
$T_w$	minimum = $1 \mu\text{s}$

### 2.3.4 Video Specification

In this architecture, video content is compressed and stored in external flash memory. Low speed SPI commands are sent from the MSP430 MCU in Local Host Control operating mode or FTDI interface in Host Mute operating mode to the DMD controller to indicate what image/video content to read from the external 2Gb flash memory. Storing the image/video content in memory removes the need for a high-speed video interface to the module which improves compatibility with typical vehicle infrastructures. It also decreases overall system size and cost by removing graphics generation and interfaces. The controller decompresses each bit plane of the video data ( $608 \times 684$  resolution) and displays them on the DMD in rapid succession to create the full video image at a frame rate of 25 Hz. A frame rate of 25 Hz is recommended due to memory constraints, but the DLP3021-Q1 can support a maximum frame rate of 60 Hz. Due to the diamond format of the DMD pixels, the output image has an effective resolution of  $864 \times 480$ . The controller synchronizes the DMD bit plane data with the RGB enable timing for the LED color controller and driver circuit.

### 3 Quick Start

Use the following instruction to setup your DLP3021-Q1 Light EVM and PC.

#### 3.1 Kit Assembly Instructions

The DLP3021-Q1 Light Engine EVM electronics board is shipped as a fully assembled unit. A diagram of all cable connections is shown in [Figure 3-1](#). The complete light engine assembly is shown in [Figure 3-2](#).

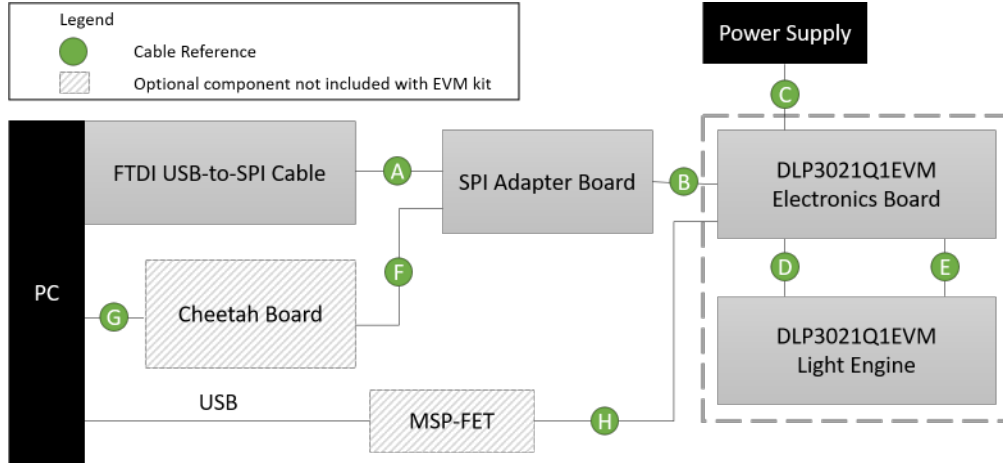

**Figure 3-1. Cable Connections**

**Table 3-1. FTDI C232HM MPSSE Cable to SPI Adapter Board Connections**

FTDI Wire Signal (Pin)	FTDI Wire Color	SPI Adapter Board FTDI Header Pin
TCK (2)	Orange	J5-1
GND (10)	Black	J5-2
TDO (4)	Green	J5-3
TDI (3)	Yellow	J5-5
TMS (5)	Brown	J5-7



**Figure 3-2. Assembled DLP3021-Q1 Light Engine EVM with FTDI**

## 3.2 Software Installation

Download and install the following software from TI:

- DLP3021-Q1 Composer Project and FPGA Configuration (*DLPC135*): <https://www.ti.com/lit/zip/dlpc135>
- DLP Control Program for the DLP3021-Q1 DMD (*DLPC136*): <https://www.ti.com/lit/zip/dlpc136>
- DLP Composer for DLP3021-Q1 (*DLPC137*): <https://www.ti.com/lit/zip/dlpc137>
- MSP430 Example Code (*DLPC138*): <https://www.ti.com/lit/zip/dlpc138>

Download and install the following from third-parties:

- The C232HM MPSSE cable requires USB device drivers, available free from <http://www.ftdichip.com>. The D2XX driver is used with application software to directly access the FT232H in the cable through a DLL.
- Optional: Total Phase Cheetah™ USB adapter: <http://www.totalphase.com/products/usb-drivers/windows>

## 3.3 Power-Up

Follow these steps to properly supply power to the EVM:

1. Connect the input power cable to a power supply that meets input power specifications defined in [Section 2.3.1](#). A 12-V supply with a 0.5-A limit is recommended for out-of-box evaluation. The red cable for the V+ terminal and black cable for the V– terminal.
2. Set the operation mode switches to the *Local Host Control* operating mode as defined in [Section 2.2.1](#). The EVM is already flash programmed with TI demo image/video content when shipped for out-of-box evaluation.
3. Turn on the supply power, and the EVM will immediately begin to display content.

## 3.4 Select Display Content

Follow these steps to run the DGP software to change the display content and settings:

1. Turn off the supply power.
2. Set the operation mode switches to the *Host Mute* operating mode as defined in [Section 2.2.1](#).
3. Turn on the supply power. [Figure 3-3](#) shows the LED status of the EVM when in the *Host Mute* operation mode.

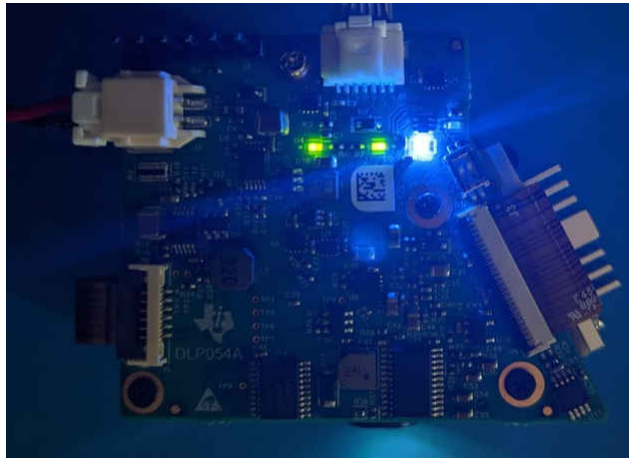

**Figure 3-3. Host Mute Operating Mode LED Status**

4. At start-up in *Host Mute* operation mode, the default content projected will be a static image of vertical color bars.
5. Confirm the FTDI cable is connected to the PC. While running DLP Control Program, click on the *Connection* list. If the FTDI cable is not already connected, click the *Connect* button. Note, the Connection settings must be a clock rate of 5 MHz and timeout of 500 ms.

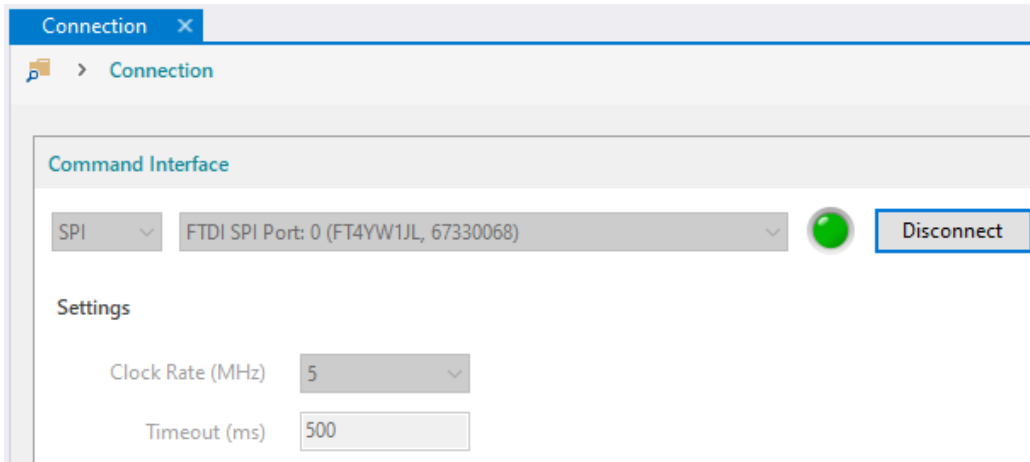

**Figure 3-4. Successful FTDI Cable Connection Established in GUI**

6. Python scripts can be run from the *Scripting* window. The script shown below can be used to select one of the pre-programmed test patterns of the DLP3021-Q1 DGP composer project. Press the green button to run the script, and the projected content will toggle between a static image and video.

7. 

```
from dgp.commands import *
#-----
#Uncomment one static test pattern
#-----
#WriteVideoStartAddress1(0x85980) # Color Bars
#WriteVideoStartAddress1(0x95F64) # Color Bars Gradient
#WriteVideoStartAddress1(0xC2734) # Solid Black
#WriteVideoStartAddress1(0xD3830) # Solid Red
#WriteVideoStartAddress1(0xE3E14) # Solid Green
#WriteVideoStartAddress1(0xF43F8) # Solid Blue
#WriteVideoStartAddress1(0x1049DC) # Solid White
#WriteVideoStartAddress1(0x114FC0) # Black to White Gradient
#WriteVideoStartAddress1(0x1546C8) # Checkerboard
#WriteVideoStartAddress1(0x179F3C) # MTF Chart
WriteVideoStartAddress1(0x1A2280) # Bird
WriteVideoConfiguration1(0,30)
#-----
#Uncomment the desired video test pattern
#-----
WriteVideoStartAddress2(0x20A98C) # Race Car
WriteVideoConfiguration2(220,0)
#-----
# Configure and run video control
#-----
VideoControl = VideoControl()
VideoControl.Play = True
VideoControl.Stop = False
VideoControl.Autostop = False
VideoControl.BufPtr = 0
VideoControl.LoopConfigs = True
VideoControl.ToggleConfigs = True
WriteVideoControl(VideoControl)
```

8. Before closing the GUI, click the *Disconnect* button in the *Connection* window to properly disconnect the FTDI cable interface. If the EVM is power cycled, repeat steps *c* and *d* to select and display content again.

### 3.5 LED Driver

The LED brightness can be controlled through PWM output from DMD controller. Using the DLP Control Program "General" tab, the PWM input text boxes (RPWM DC, GPWM DC, and BPWM DC) control the current through each LED driver channel. Note that the PWM control may exceed the maximum current specification of some LEDs in certain LED configurations. [Table 3-2](#) provides reference conversions from PWM level to drive current for commonly used current levels.

**Table 3-2. LED PWM Drive Current Conversion Reference**

PWM LEVEL (10-bit)	DRIVER CURRENT (mA)
0	≈ 0 <sup>(1)</sup>
128	142
256	284
384	426
450	500
512	568
640	710
768	852
896	995
1024	1137

<sup>(1)</sup> = Some current will continue to flow through the LED with a PWM level of 0 and light output may still be visible. To fully remove LED current, the DMD controller must be set to disable the PWM outputs.

**Note**

The RGB LEDs included with the DLP3021LEQ1EVM have maximum continuous forward current ratings of 0.5 A, and maximum forward current pulsed ratings of up to 1 A.

## **4 Optics and Mechanics**

Both optics and recommended heat sinks (DMD and LED) are included with the DLP3021-Q1 Light Engine EVM. These heat sinks have been designed to operate the DLP3021-Q1 DMD and LEDs within their data sheet specifications.



## 5 Software

### 5.1 DLP Composer

DLP Composer for DLP3021-Q1 is a software tool that allows users to configure and generate firmware flash data for the DMD controller of the EVM. In the case of the DLP3021LEQ1EVM, the firmware file generated is specific to the FPGA based DMD controller, and loaded into external SPI flash memory. The DMD controller executes commands to read image/video content from the SPI flash memory, and processes the content into the Data Rate (DDR) interface format compatible with the DLP3021-Q1 data bus. The image/video content must be flashed into the external SPI flash memory prior to running the GUI. Image/video content cannot be uploaded or streamed in real-time to the DMD controller.

The DLP Composer DGP process is explained with more detail in the *DLP3021-Q1 Dynamic Ground Projection System Design (DLPA086)* report.

#### 5.1.1 Default Register Configuration

This page determines the default start-up conditions of select DMD controller registers. Certain registers enable read and write permissions during typical operation to allow settings to be changed after flash programming, while certain registers only allow read permissions after flash programming during typical operation. See the *DLP3021-Q1 FPGA User's Guide (DLPU100)* for details on each register.

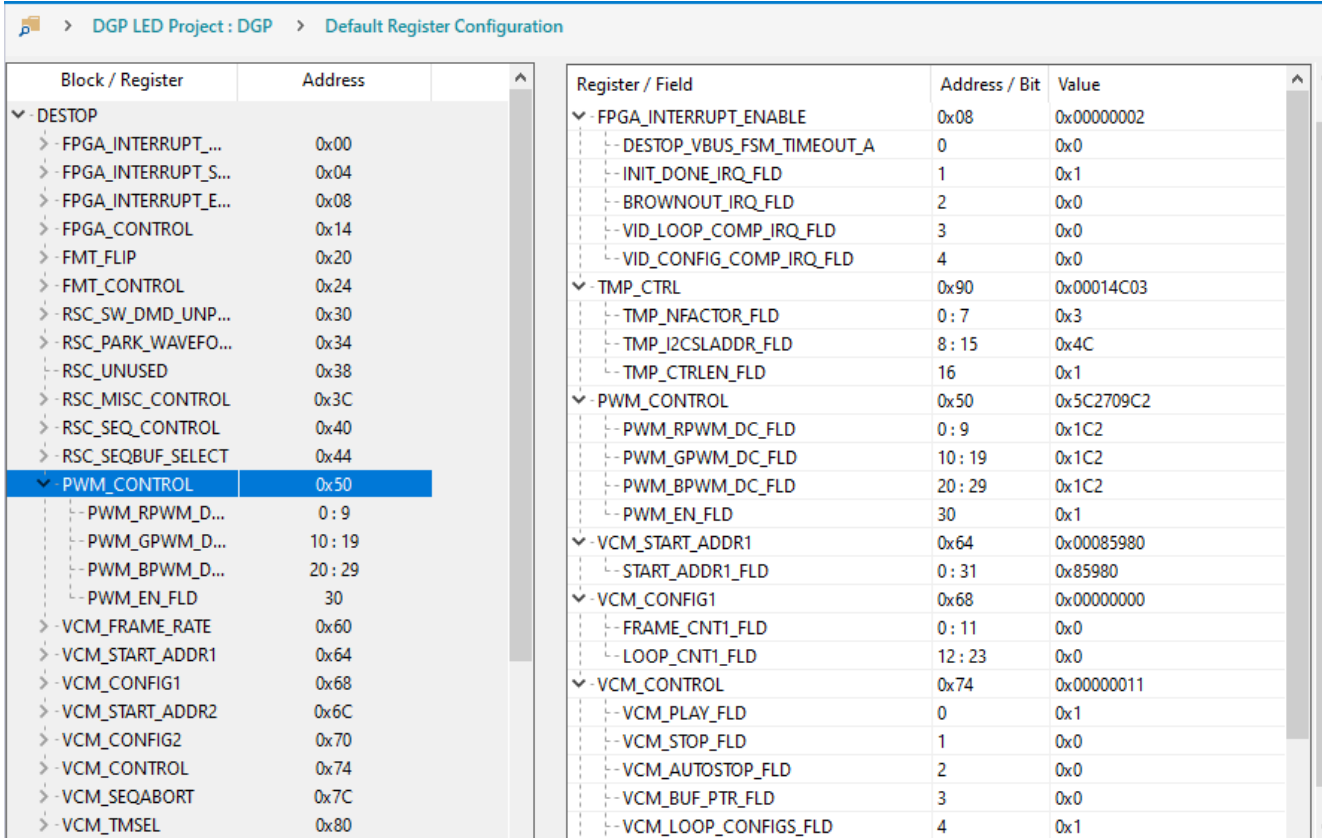

Block / Register	Address	Register / Field	Address / Bit	Value
DESTOP		FPGA_INTERRUPT_ENABLE	0x08	0x00000002
> -FPGA_INTERRUPT_...	0x00	-- DESTOP_VBUS_FSM_TIMEOUT_A	0	0x0
> -FPGA_INTERRUPT_S...	0x04	-- INIT_DONE_IRQ_FLD	1	0x1
> -FPGA_INTERRUPT_E...	0x08	-- BROWNOUT_IRQ_FLD	2	0x0
> -FPGA_CONTROL	0x14	-- VID_LOOP_COMP_IRQ_FLD	3	0x0
> -FMT_FLIP	0x20	-- VID_CONFIG_COMP_IRQ_FLD	4	0x0
> -FMT_CONTROL	0x24			
> -RSC_SW_DMD_UNP...	0x30	▼ TMP_CTRL	0x90	0x00014C03
> -RSC_PARK_WAVEFO...	0x34	-- TMP_NFACTOR_FLD	0 : 7	0x3
-- RSC_UNUSED	0x38	-- TMP_I2CSLADDR_FLD	8 : 15	0x4C
> -RSC_MISC_CONTROL	0x3C	-- TMP_CTRLLEN_FLD	16	0x1
> -RSC_SEQ_CONTROL	0x40	▼ PWM_CONTROL	0x50	0x5C2709C2
> -RSC_SEQBUF_SELECT	0x44	-- PWM_RPWM_DC_FLD	0 : 9	0x1C2
▼ PWM_CONTROL	0x50	-- PWM_GPWM_DC_FLD	10 : 19	0x1C2
-- PWM_RPWM_D...	0 : 9	-- PWM_BPWM_DC_FLD	20 : 29	0x1C2
-- PWM_GPWM_D...	10 : 19	-- PWM_EN_FLD	30	0x1
-- PWM_BPWM_D...	20 : 29	▼ VCM_START_ADDR1	0x64	0x00085980
-- PWM_EN_FLD	30	-- START_ADDR1_FLD	0 : 31	0x85980
> -VCM_FRAME_RATE	0x60	▼ VCM_CONFIG1	0x68	0x00000000
> -VCM_START_ADDR1	0x64	-- FRAME_CNT1_FLD	0 : 11	0x0
> -VCM_CONFIG1	0x68	-- LOOP_CNT1_FLD	12 : 23	0x0
> -VCM_START_ADDR2	0x6C	▼ VCM_CONTROL	0x74	0x00000011
> -VCM_CONFIG2	0x70	-- VCM_PLAY_FLD	0	0x1
> -VCM_CONTROL	0x74	-- VCM_STOP_FLD	1	0x0
> -VCM_SEQABORT	0x7C	-- VCM_AUTOSTOP_FLD	2	0x0
> -VCM_TMSEL	0x80	-- VCM_BUF_PTR_FLD	3	0x0
		-- VCM_LOOP_CONFIGS_FLD	4	0x1

Figure 5-1. DLP Composer - Default Register Configuration

Key settings to configure on this page include:

- whether or not content should be displayed immediately after power-up.
- the ready state default display content immediately after power-up.
- the PWM and duty cycle of each LED driver, and the PWM enable state.



### 5.1.2 Illumination

This page allows the DMD controller to introduce additional enable delay, disable delay, and fall margin to the LED illumination transition states. Though not always required, some LEDs or applications may require this additional delay for power budget optimization, more precise LED on/off timing, calibration, dimming, or other LED driver related countermeasures. To prioritize brightness, the delays should be disabled or kept as short as possible.

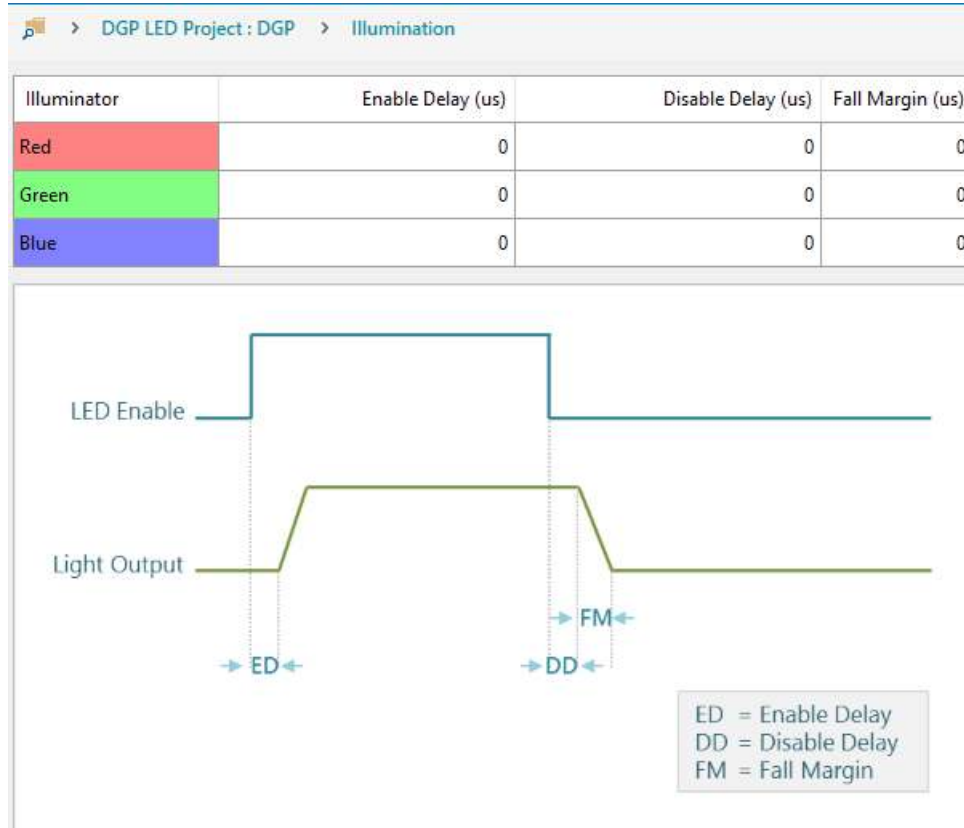

Figure 5-2. DLP Composer - Illumination

### 5.1.3 Sequence Set

The sequence sets determine the frame rate and duty cycle partition of each RGB color. The recommended frame rate is 25 Hz. Ideally, the duty cycle of the three color (red, green, and blue) would be split equally at 33% each; however, a larger green duty cycle is recommended to achieve a higher brightness output.

	Build	Sequence Set Name	Frame Rate (Hz)	Red Duty Cycle	Green Duty Cycle	Blue Duty Cycle	Description
0	<input checked="" type="checkbox"/>	baseline	25	34	40.8	25.2	
1	<input checked="" type="checkbox"/>	high brightness	25	24.9	62.4	12.7	
*	<input type="checkbox"/>						

Figure 5-3. DLP Composer - Sequence Set

The TI created project will include two sequences: baseline and high brightness. TI recommends using the baseline sequence for optimal color, and only using the high brightness sequence to maximize the lumens output.

The duty cycling of each color is made possible through the use of a multiplexer with active channel selection by the PWM\_SEL\_0 and PWM\_SEL\_1 pins of the FPGA. This, in combination with the overall LED driver, PWM

of each color, and shunt enable, gives the ability to select different current limits for each of the colors, which is important for color calibration and dimming the image for thermal derating.

#### 5.1.4 Degamma Curves

This page allows the use to select one of five different gamma profile curves that apply identically to all three RGB channels:

- *enhanced.dgm* – Enhanced: More bits allocated to low light levels where steps in brightness are more noticeable to human perception. Recommended for full range of brightness intensities.
- *enhphoto.dgm* – Enhanced Photo: Same as Enhanced with a more linear mapping in the high brightness range.
- *linear.dgm* – Linear: Pass through of input to out pixel intensity where pixel intensity remains unchanged. Recommended for high brightness content.
- *maxbright.dgm* – Same as enhanced, but steeper slope to reach high brightness content saturation sooner. Recommended for binary content that is a combination of very low and high brightness content as middle range resolution is reduced.
- *photo.dgm* – Photo: More bits allocated to low and medium light levels. Recommended for content where high brightness is less of a priority.

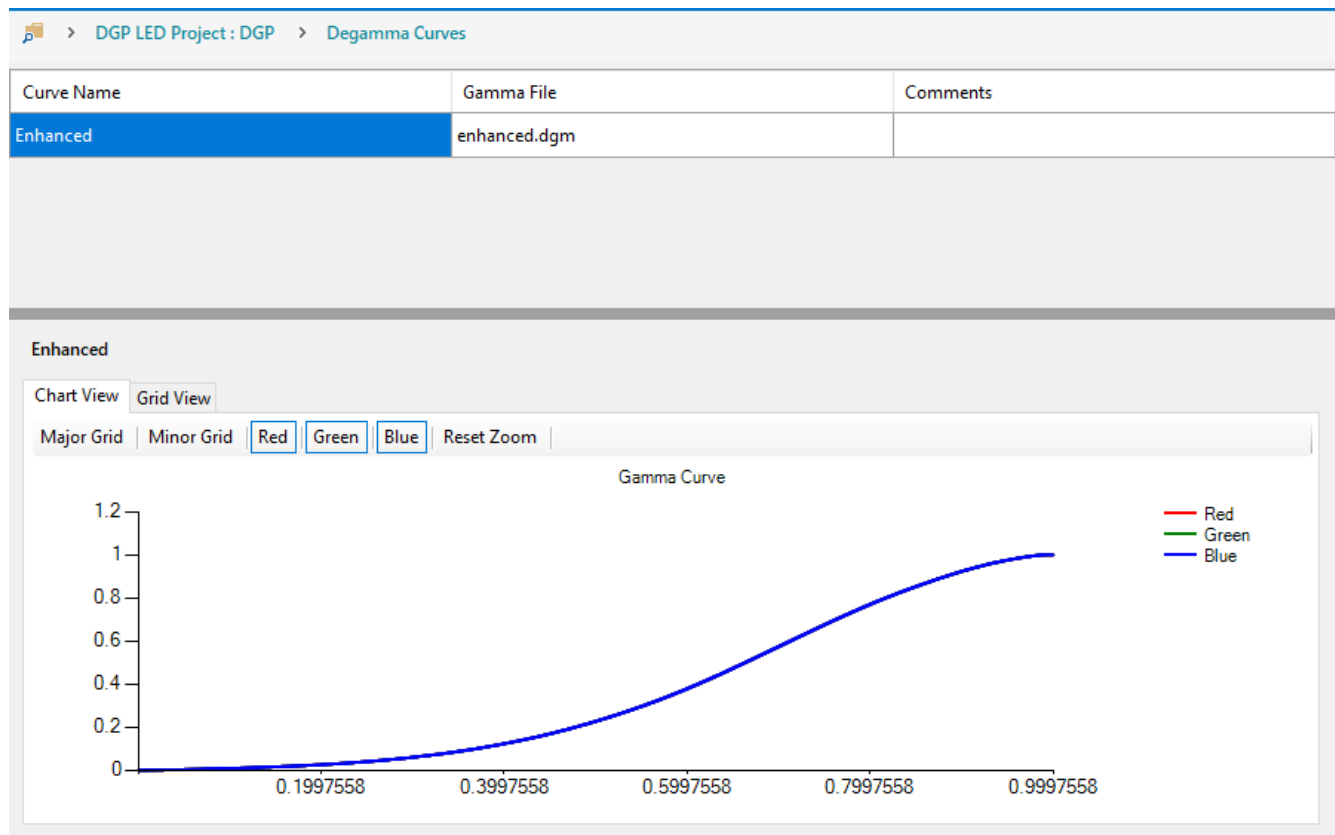

**Figure 5-4. DLP Composer - Degamma Curves**

Gamma correction is a method of adjusting the mapping of input to output pixel intensity levels that is generally used to account for visual perception of brightness. This process is common to most display and camera systems. The human visual system does not perceive light intensity linearly. Humans are more capable of perceiving fine brightness differences in low light intensity levels than they are in bright intensity levels. Therefore, source video content is typically gamma encoded to optimize bit allocation by providing more bits to low light levels where steps in brightness will be most noticeable. Then, the display will apply a corresponding de-gamma curve to decode the input bits into corresponding display brightness.

See the *DLP5531-Q1 Chipset Video Processing for Light Control Applications (DLPA101)* for additional details on the effects of gamma curves.

### 5.1.5 Image/Video

This page allows the user to select the image/video content that is to be programmed into the SPI flash memory. For the content to be a selectable option, the image/video file must be available in the following directory DLP Composer project: “(dgp\_project\_root)\Inputs\Videos”. Check the *Build* check box for the content to be included or excluded from the firmware build.

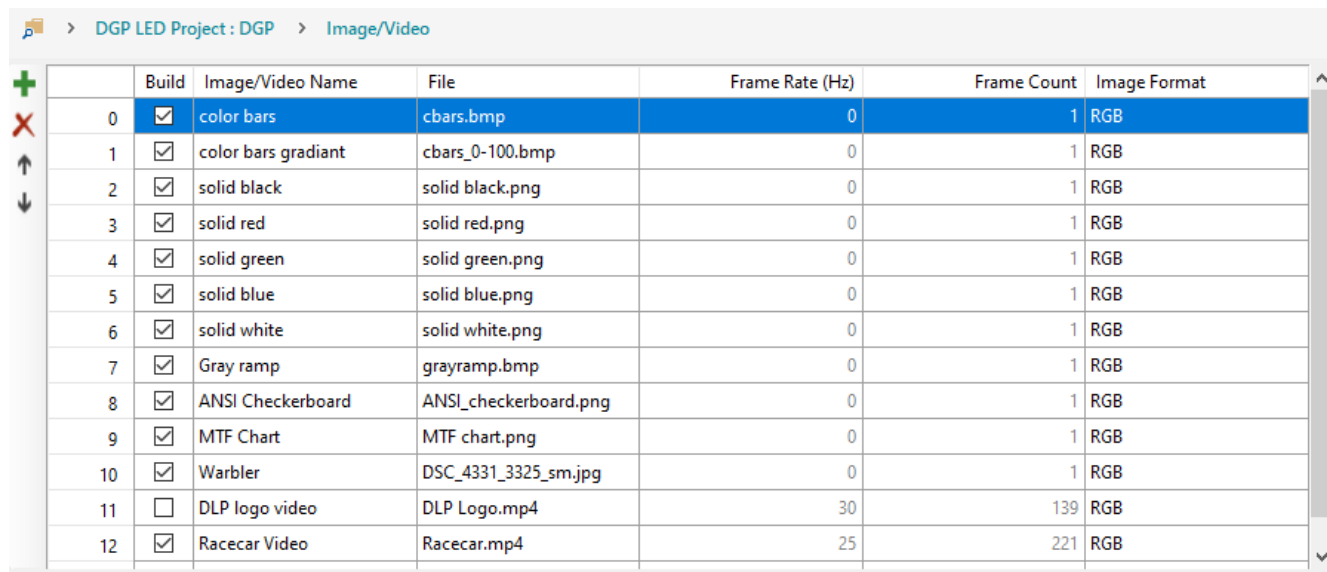

	Build	Image/Video Name	File	Frame Rate (Hz)	Frame Count	Image Format
0	<input checked="" type="checkbox"/>	color bars	cbars.bmp	0	1	RGB
1	<input checked="" type="checkbox"/>	color bars gradient	cbars_0-100.bmp	0	1	RGB
2	<input checked="" type="checkbox"/>	solid black	solid black.png	0	1	RGB
3	<input checked="" type="checkbox"/>	solid red	solid red.png	0	1	RGB
4	<input checked="" type="checkbox"/>	solid green	solid green.png	0	1	RGB
5	<input checked="" type="checkbox"/>	solid blue	solid blue.png	0	1	RGB
6	<input checked="" type="checkbox"/>	solid white	solid white.png	0	1	RGB
7	<input checked="" type="checkbox"/>	Gray ramp	grayramp.bmp	0	1	RGB
8	<input checked="" type="checkbox"/>	ANSI Checkerboard	ANSI_checkerboard.png	0	1	RGB
9	<input checked="" type="checkbox"/>	MTF Chart	MTF chart.png	0	1	RGB
10	<input checked="" type="checkbox"/>	Warbler	DSC_4331_3325_sm.jpg	0	1	RGB
11	<input type="checkbox"/>	DLP logo video	DLP Logo.mp4	30	139	RGB
12	<input checked="" type="checkbox"/>	Racecar Video	Racecar.mp4	25	221	RGB

**Figure 5-5. DLP Composer - Image/Video**

This EVM allows users to store approximately twenty seconds of full-color content in the 2-Gb SPI flash device. However, content duration can be increased by optimizing content and setting the correct illumination (RGB or single color) to match the type of content being displayed. The video content must be in .MP4 format to be compatible with DLP Composer.

### 5.1.6 Flash Blocks

The flash memory for the DGP system is divided into five major blocks. Creation of the flash binary is handled entirely by DLP Composer. The FPGA Configuration for the Xilinx XA7S15-1CPGA196Q Spartan®-7 FPGA is already compiled and included with the example project provided by Texas Instruments.

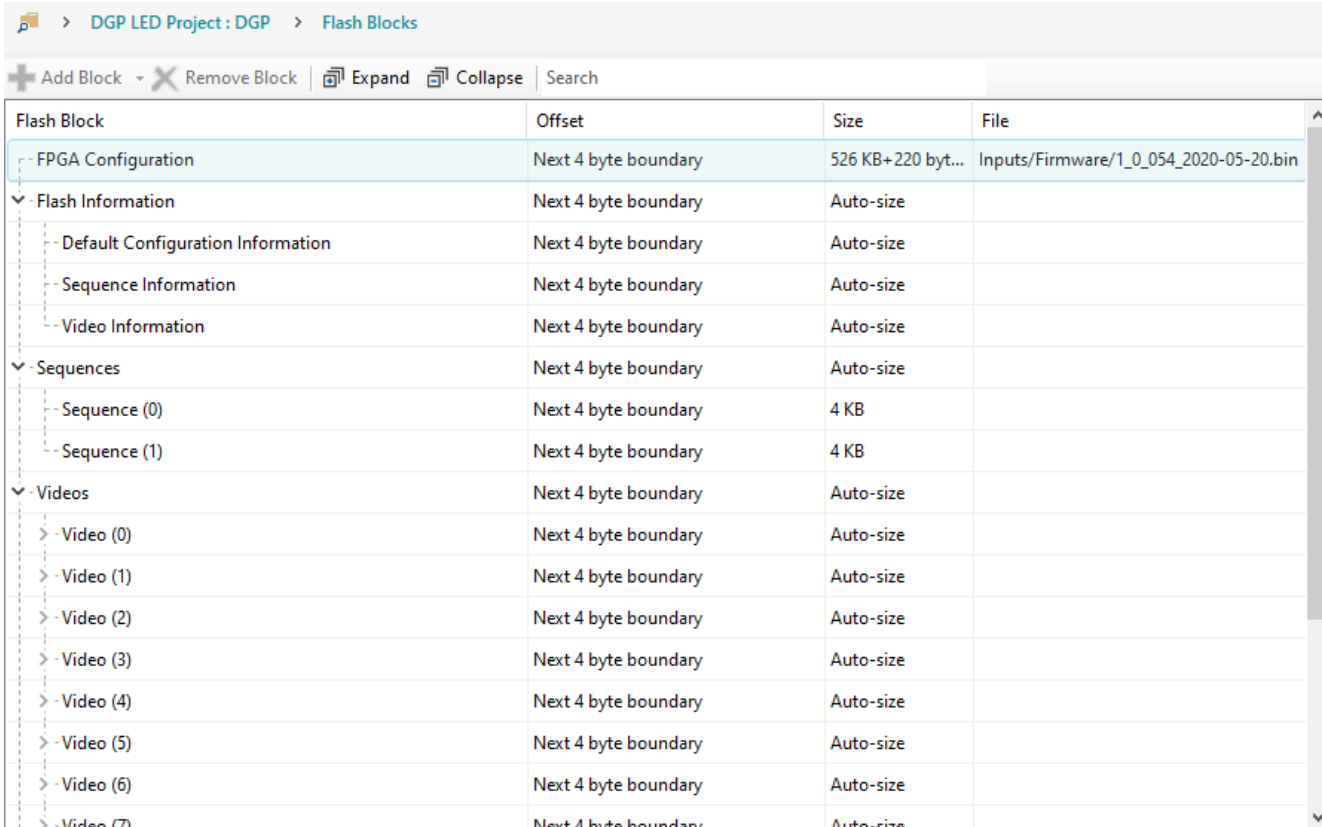

The screenshot shows the 'Flash Blocks' section in the DLP Composer. It features a toolbar with 'Add Block', 'Remove Block', 'Expand', 'Collapse', and 'Search' buttons. Below the toolbar is a table listing the flash blocks with columns for 'Flash Block', 'Offset', 'Size', and 'File'. The blocks are organized into a tree structure with expandable/collapsible icons.

Flash Block	Offset	Size	File
FPGA Configuration	Next 4 byte boundary	526 KB+220 byt...	Inputs/Firmware/1_0_054_2020-05-20.bin
Flash Information	Next 4 byte boundary	Auto-size	
-- Default Configuration Information	Next 4 byte boundary	Auto-size	
-- Sequence Information	Next 4 byte boundary	Auto-size	
-- Video Information	Next 4 byte boundary	Auto-size	
Sequences	Next 4 byte boundary	Auto-size	
-- Sequence (0)	Next 4 byte boundary	4 KB	
-- Sequence (1)	Next 4 byte boundary	4 KB	
Videos	Next 4 byte boundary	Auto-size	
> -Video (0)	Next 4 byte boundary	Auto-size	
> -Video (1)	Next 4 byte boundary	Auto-size	
> -Video (2)	Next 4 byte boundary	Auto-size	
> -Video (3)	Next 4 byte boundary	Auto-size	
> -Video (4)	Next 4 byte boundary	Auto-size	
> -Video (5)	Next 4 byte boundary	Auto-size	
> -Video (6)	Next 4 byte boundary	Auto-size	
> -Video (7)	Next 4 byte boundary	Auto-size	

**Figure 5-6. DLP Composer - Flash Blocks**

**Table 5-1. Top Level Flash Structure**

DATA	ADDRESS	LENGTH
FPGA Configuration	0x0	0x838DC
Flash Information	0x83900	Variable
Default Configuration (Defconfig)	Variable	Variable
Sequence 1	Variable	0x1000
Sequence 2	Variable	0x1000
Sequence ...	Variable	0x1000
Sequence n	Variable	0x1000
Video / Image 1	Variable	Variable
Video / Image 2	Variable	Variable
Video / Image ...	Variable	Variable
Video / Image n	Variable	Variable

### FPGA Configuration

The FPGA configuration block is always located at address 0x0, and is always a fixed size of 0x838DC bytes. This size is derived from the Xilinx XA7S15 specification for maximum configuration length. See the Xilinx UG470 ([https://www.xilinx.com/support/documentation/user\\_guides/ug470\\_7Series\\_Config.pdf](https://www.xilinx.com/support/documentation/user_guides/ug470_7Series_Config.pdf)) for additional details.

### Flash Information

The flash information block provides metadata regarding the contents of the flash. This is intended to allow an external MCU or software tool understand the contents of the flash. For example, it defines the locations of the

videos within flash so that they can be loaded dynamically by an MCU, such as the MSP430G2553-Q1 on the EVM. The flash information block is divided into four main sections as shown in [Table 5-2](#). Information such as the number of sequences is provided so that software can navigate the flash block and determine the correct offset for the data of interest. The number of sequence and video entries in the information block is variable, but each entry is a fixed size.

**Table 5-2. Flash Information Block**

Offset (HEX)	0	1	2	3
00	Major	Minor	Patch	
04	"D"	"E"	"F"	"C"
08	Block Address			
0C	Count (Number of Register Writes)			
10	"S"	"E"	"Q"	"L"
14	Size (of Sequence Block)			
18	Count (Number of Sequences)			
1C	Sequence 0 Address			
20	Seq 0 Red Duty Cycle		Seq 0 Green Duty Cycle	
24	Seq 0 Blue Duty Cycle		Seq 0 Frame Rate	
28	Sequence 1 Address			
2C	Seq 1 Red Duty Cycle		Seq 1 Red Duty Cycle	
30	Seq 1 Blue Duty Cycle		Seq 1 Blue Duty Cycle	
34	Sequence ... Address			
38	Seq ... Red Duty Cycle		Seq ... Red Duty Cycle	
3C	Seq ... Blue Duty Cycle		Seq ... Blue Duty Cycle	
Variable	"V"	"I"	"D"	"E"
Variable	Size (of Video Block)			
Variable	Count (Number of Videos)			
Variable	Video 0 Address			
Variable	Video 0 Frame Rate		Video 0 Frame Count	
Variable	Video 1 Address			
Variable	Video 1 Frame Rate		Video 1 Frame Rate	
Variable	Video ... Address			
Variable	Video ... Frame Rate		Video ... Frame Rate	

### Sequences

Sequences are generated by DLP Composer based on the duty cycle selection. Each sequence entry is reserved 4kB in flash.

### Videos

Videos and still image content are an input to a dynamic ground projection project in DLP Composer. Composer takes the content, scales it, converts it to a sequence of DMD native format bit-planes, and compresses it using run length encoding (RLE) for storage in flash. When a video or still image is to be shown, the FPGA decompresses each bit-plane and displays in the order and with the timings specified by the sequence.

### Default Configuration

The default configuration block is the set of values for each of the FPGA registers. This information is loaded by the FPGA after the completion of the FPGA configuration. These values supersede the power-on default values

described in the *DLP3021-Q1 FPGA User's Guide*. Default configuration values can be set using DLP Composer on the *Default Register Configuration* page.

### 5.1.7 Flash Programming

Once the DLP Composer project is configured as desired, use the *Flash Programming* page to program and verify the flash binary onto the SPI flash memory of the EVM.

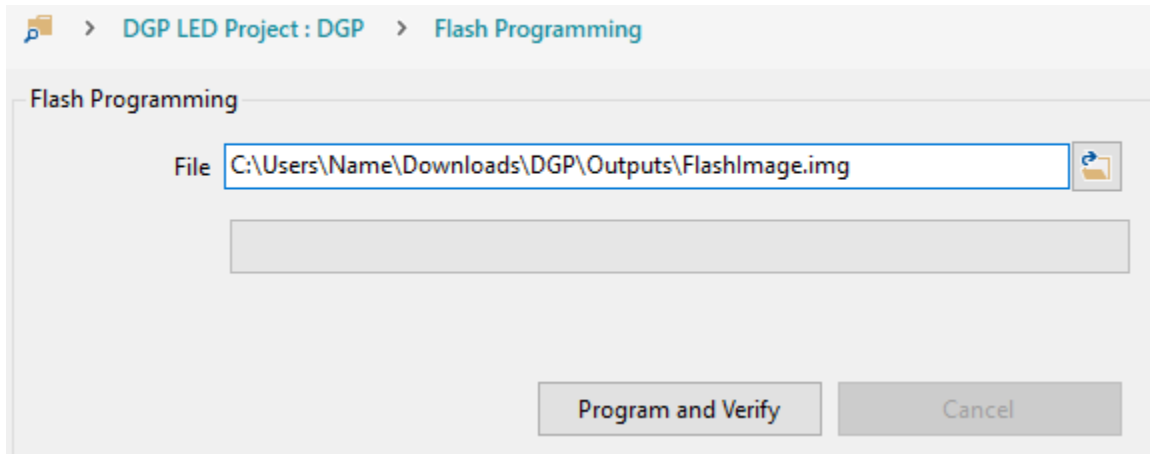

**Figure 5-7. DLP Composer - Flash Programming**

Follow these steps to flash program the EVM:

1. Start with the EVM powered-off.
2. Set the SPI Adapter board to the *Flash Programming* operating mode.
3. Connect the FTDI cable interface to the SPI Adapter Board and PC.
4. Power-on the EVM. [Figure 5-8](#) shows the LED status of the EVM when in the *Flash Programming* operation mode.

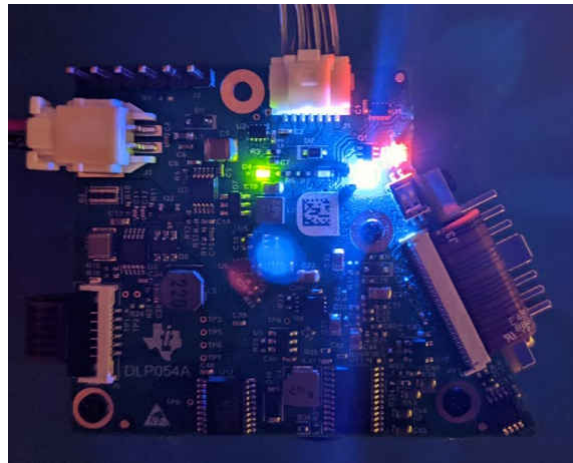

**Figure 5-8. Flash Programming Operating Mode LED Status**

5. Import and open the DLP3021LEQ1EVM DGP project in DLP Composer.
6. Navigate to the Connections tab. Set to *SPI* and *FTDI SPI Port*, then click the *Connect* button. The virtual green LED should illuminate to indicate a successful connection as shown in [Figure 5-9](#).

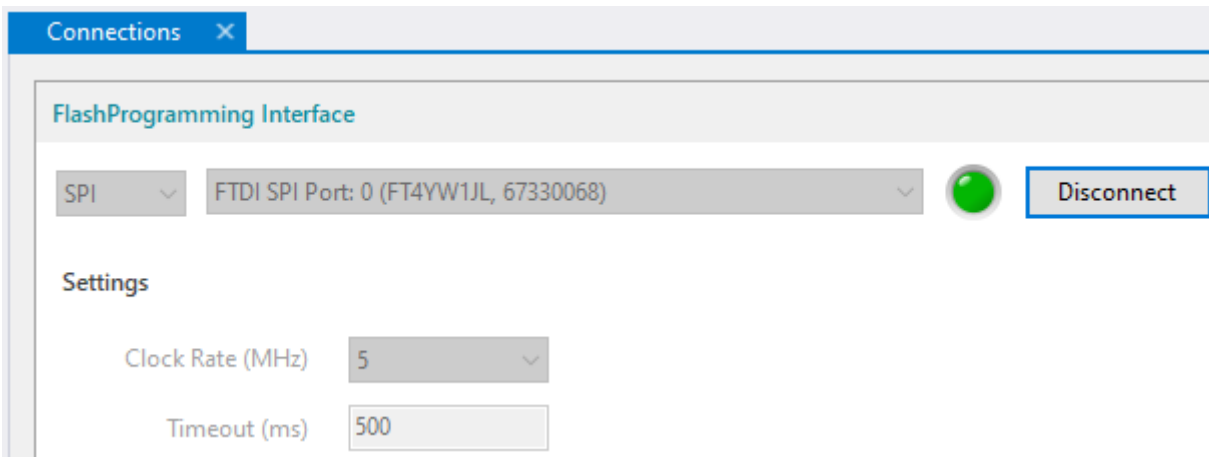

**Figure 5-9. DLP Composer - Connections**

7. Build the DLP Composer project using the *Project* → *Build* from the menu bar. Ensure the build is completed and successful before proceeding. Note, the build time will vary and can take up to several minutes depending on the size of the image/video content block.
8. Navigate to the *Flash Programming* page, and browse to select the flash image file from the following directory: “(dgp\_project\_root)\Outputs\FlashImage.img”.
9. Click the *Program and Verify* button to flash program the EVM. Note, the flash programming time will vary and can take up to several minutes depending on the size of the image/video content block.

## 5.2 DLP Control Program

DLP Control Program for the DLP3021-Q1 allows users to use the FTDI cable to issue commands to the FPGA via SPI to read/write registers, enable video playback, change videos, read DMD temperature via the TMP411, or adjust current levels to the LEDs.

To change the DLP Control Program window and pages for DLP3021LEQ1EVM support, navigate to *Product* → *Dynamic Ground Projection for Automotive* in the menu bar.

### 5.2.1 Connection

The first step in running the GUI requires the user to establish connection to the FTDI cable. The GUI will attempt to automatically connect to the FTDI cable at start-up. To manually connect the FTDI cable, navigate to the *Connection* page. With the FTDI cable selected from the drop-down interface list, click the *Connect* button. Note, the Connection settings must be a clock rate of 5 MHz and timeout of 500 ms. When using the Cheetah™ interface, the clock rate can be increased to 16 MHz in SPI Mode 0 and MSB first bit order.

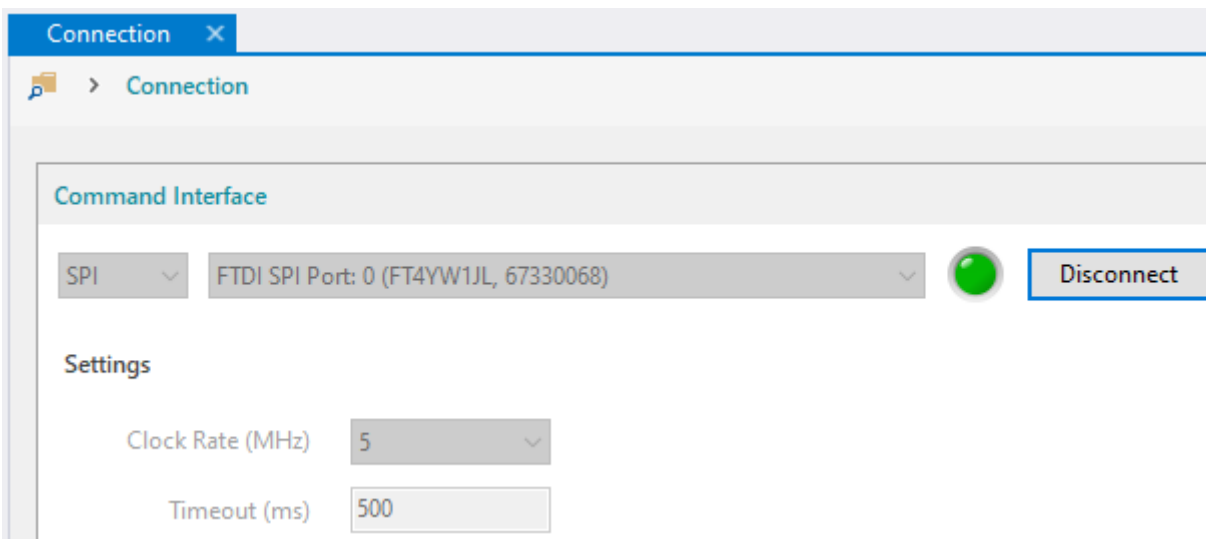

**Figure 5-10. DLP Control Program - Connection**

### Note

The FTDI cable must be disconnected/released from DLP Composer if DLP Composer was previously used to flash program the EVM. The FTDI cable cannot be shared simultaneously between DLP Composer and DLP Control Program.

## 5.2.2 Scripting

The Scripting page allows for the automated execution of a custom list of SPI-to-FPGA commands to sweep and run a variety of tests. The scripting terminal uses the Python programming language. For example, the Python script can be used to cycle through all the image/video content in a loop for demo purposes.

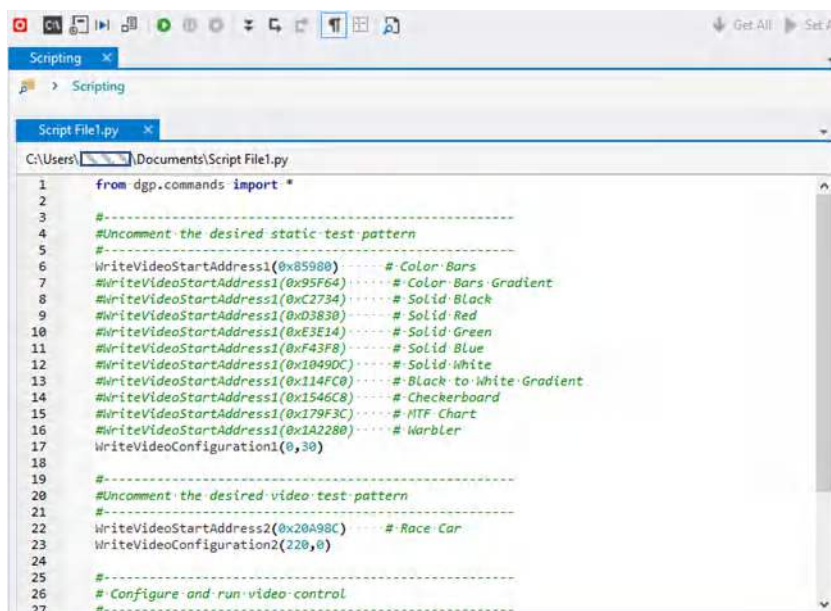
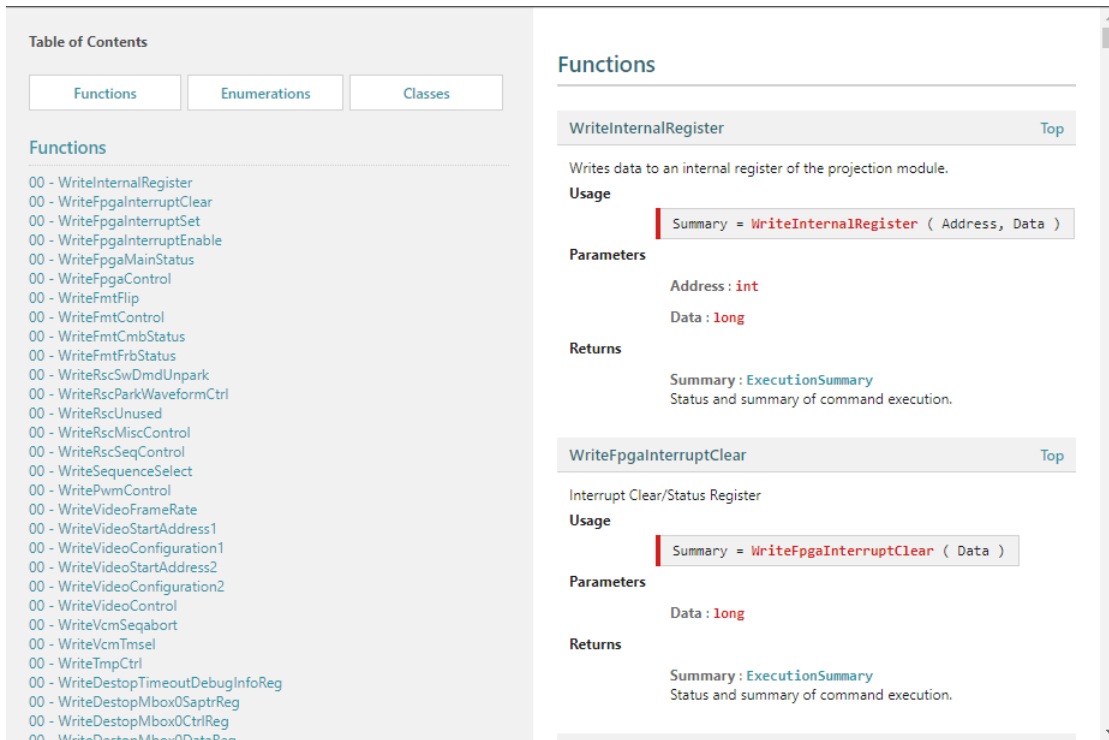

**Figure 5-11. DLP Control Program - Scripting**

To run the Python script, click the green *Run Script* button at the top of the page. If the Python script is not programmed to automatically end, the script can be stopped at any point by clicking the red *Stop Script* button at the top of the page.



For a list of the available functions that the Python script tool can call, navigate to *Help* → *Scripting Reference* in the menu bar to open the Scripting Reference manual. Each function includes a description and the input/output parameter details.



**Figure 5-12. DLP Control Program - Scripting Reference**

### 5.2.3 Registers

The Registers page allows users to perform individual read/writes of the block, register, or bit fields of the FPGA registers.

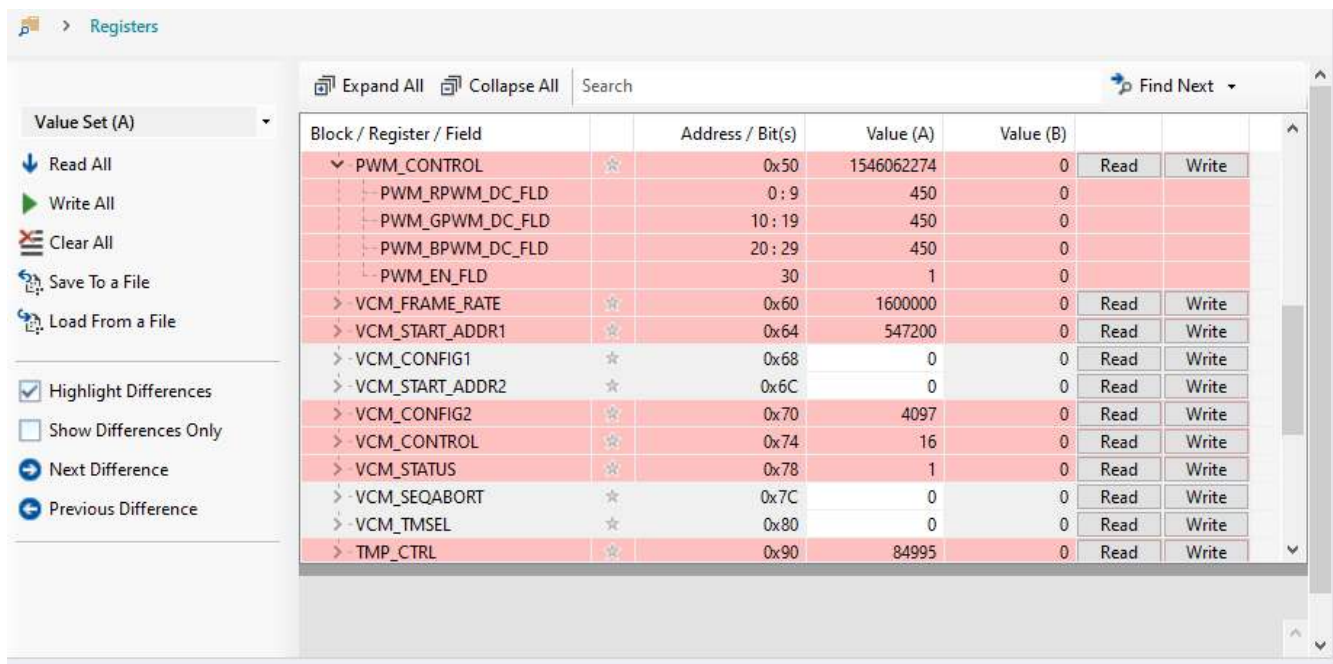

**Figure 5-13. DLP Control Program - Registers**

## 5.2.4 Commands

The commands page allows users to read/write settings in a grouped format. To read the currently set values, click the *Get* button. For commands that enable writes, update the command fields, then click the *Set* button for the values to immediately take effect.

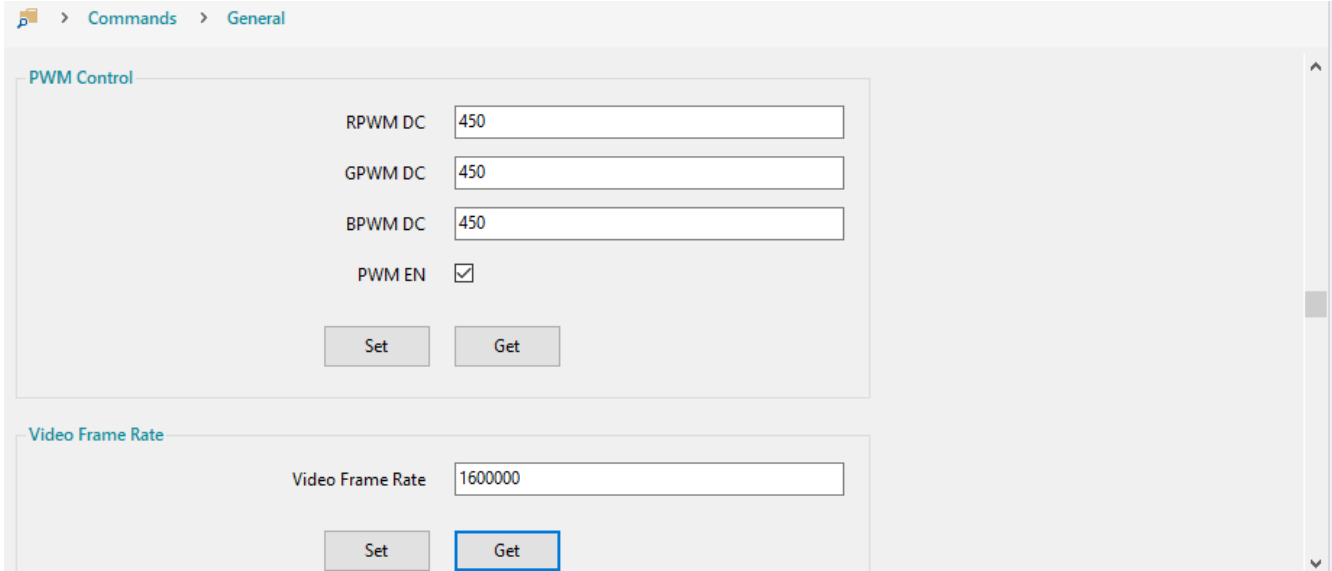

The screenshot shows the 'Commands' page in the DLP Composer software, specifically the 'General' tab. It features two main sections: 'PWM Control' and 'Video Frame Rate'. The 'PWM Control' section includes three input fields for 'RPWM DC', 'GPWM DC', and 'BPWM DC', all set to the value '450'. Below these is a checkbox for 'PWM EN' which is checked. At the bottom of this section are 'Set' and 'Get' buttons. The 'Video Frame Rate' section has a single input field for 'Video Frame Rate' set to '1600000', with 'Set' and 'Get' buttons below it. The 'Get' button in the Video Frame Rate section is highlighted with a blue border.

**Figure 5-14. DLP Composer - Commands**

## 5.3 MSP430 Example Code

When power is applied to the system, the FPGA configuration is loaded to the FPGA. Depending on the default configuration, the FPGA begins loading bit-planes to the DMD and sequencing the LED enables for each bit plane loaded. Alternatively, a microcontroller such as the MSP430G2553-Q1 on the EVM, can issue commands to the FPGA via SPI to enable video playback, change videos, read DMD temperature via the TMP411, or adjust current levels to the LEDs. The *MSP430 Example Code (DLPC138)* is a Code Composer Studio example project available for users to edit and refer to for a custom *Local Host Control* operation mode implementation.

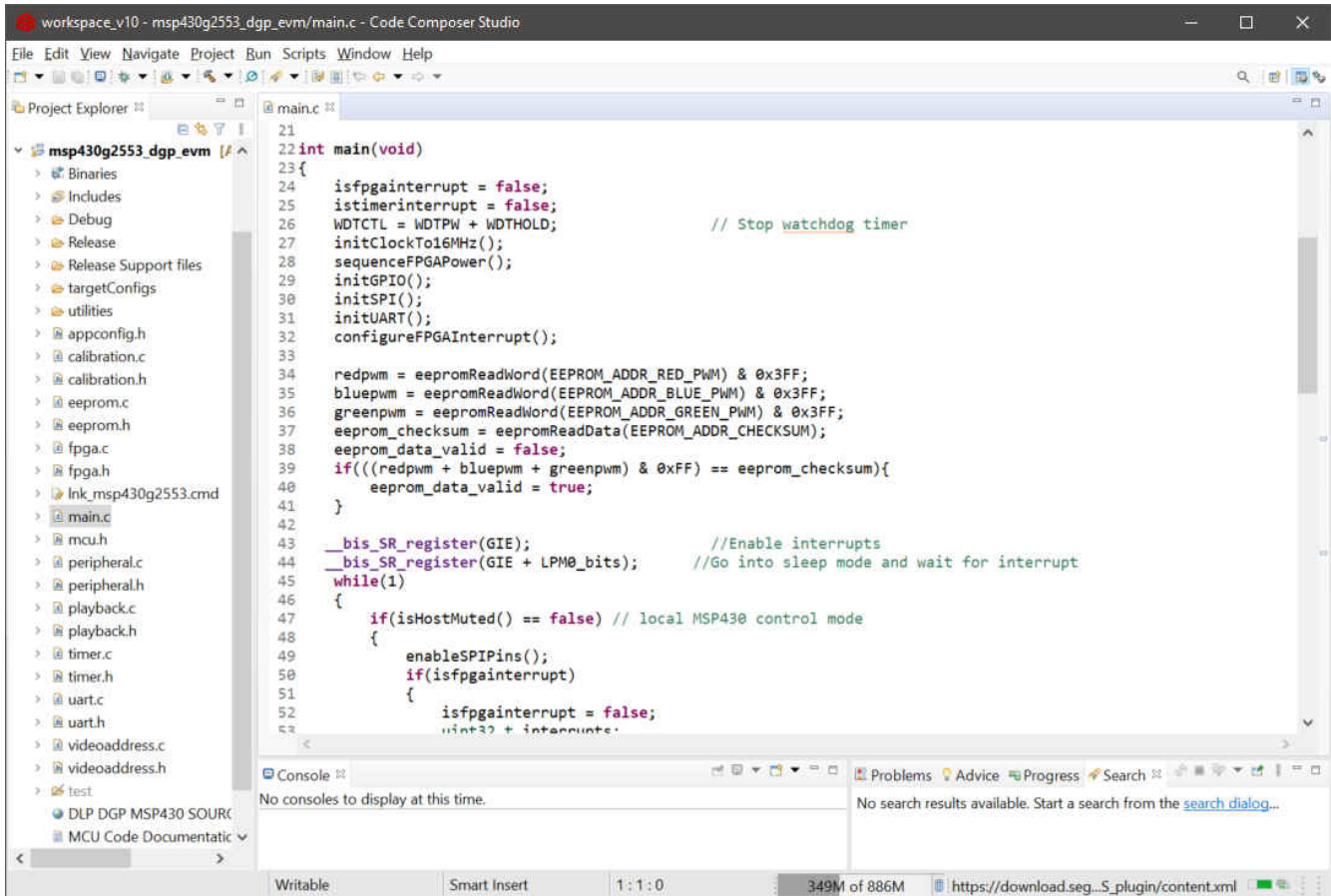

Figure 5-15. MSP430G2553-Q1 Code Composer Example Project for DGP EVM

## 6 Revision History

NOTE: Page numbers for previous revisions may differ from page numbers in the current version.

Changes from Revision * (March 2021) to Revision A (October 2021)	Page
• Changed footnote 1 from "LED PWM = 450" to "LED PWM = 1023" in <a href="#">Table 2-2</a> .....	8
• Changed footnote 2 from "LED PWM = 450" to "LED PWM = 1023" in <a href="#">Table 2-2</a> .....	8
• Changed Full On/Full Off Contrast from "measured at center of image" to "average" in <a href="#">Table 2-2</a> .....	8
• Changed Field of View from "14 × 7" to "18.3 × 10.4" in <a href="#">Table 2-2</a> .....	8
• Corrected script from "VideoControl.ToggleConfigs = TrueWrite" to "VideoControl.ToggleConfigs = True" in <a href="#">Select Display Content</a> .....	12
• Corrected script from "VideoControl(VideoControl)" to "WriteVideoControl(VideoControl)" in <a href="#">Select Display Content</a> .....	12

## IMPORTANT NOTICE AND DISCLAIMER

TI PROVIDES TECHNICAL AND RELIABILITY DATA (INCLUDING DATA SHEETS), DESIGN RESOURCES (INCLUDING REFERENCE DESIGNS), APPLICATION OR OTHER DESIGN ADVICE, WEB TOOLS, SAFETY INFORMATION, AND OTHER RESOURCES "AS IS" AND WITH ALL FAULTS, AND DISCLAIMS ALL WARRANTIES, EXPRESS AND IMPLIED, INCLUDING WITHOUT LIMITATION ANY IMPLIED WARRANTIES OF MERCHANTABILITY, FITNESS FOR A PARTICULAR PURPOSE OR NON-INFRINGEMENT OF THIRD PARTY INTELLECTUAL PROPERTY RIGHTS.

These resources are intended for skilled developers designing with TI products. You are solely responsible for (1) selecting the appropriate TI products for your application, (2) designing, validating and testing your application, and (3) ensuring your application meets applicable standards, and any other safety, security, regulatory or other requirements.

These resources are subject to change without notice. TI grants you permission to use these resources only for development of an application that uses the TI products described in the resource. Other reproduction and display of these resources is prohibited. No license is granted to any other TI intellectual property right or to any third party intellectual property right. TI disclaims responsibility for, and you will fully indemnify TI and its representatives against, any claims, damages, costs, losses, and liabilities arising out of your use of these resources.

TI's products are provided subject to [TI's Terms of Sale](#) or other applicable terms available either on [ti.com](http://ti.com) or provided in conjunction with such TI products. TI's provision of these resources does not expand or otherwise alter TI's applicable warranties or warranty disclaimers for TI products.

TI objects to and rejects any additional or different terms you may have proposed.

Mailing Address: Texas Instruments, Post Office Box 655303, Dallas, Texas 75265  
Copyright © 2022, Texas Instruments Incorporated