

ITEM NO.	PART NUMBER	DESCRIPTION	QTY.	COMPONENT NOTES
1	TLY-13	NEMA 5-15P	1	PVC, black
2	30-01362	Wire, 3C, 14 AWG, UL SJT, 300V, 105C, 9.25 mm, VW-1, PVC	1	

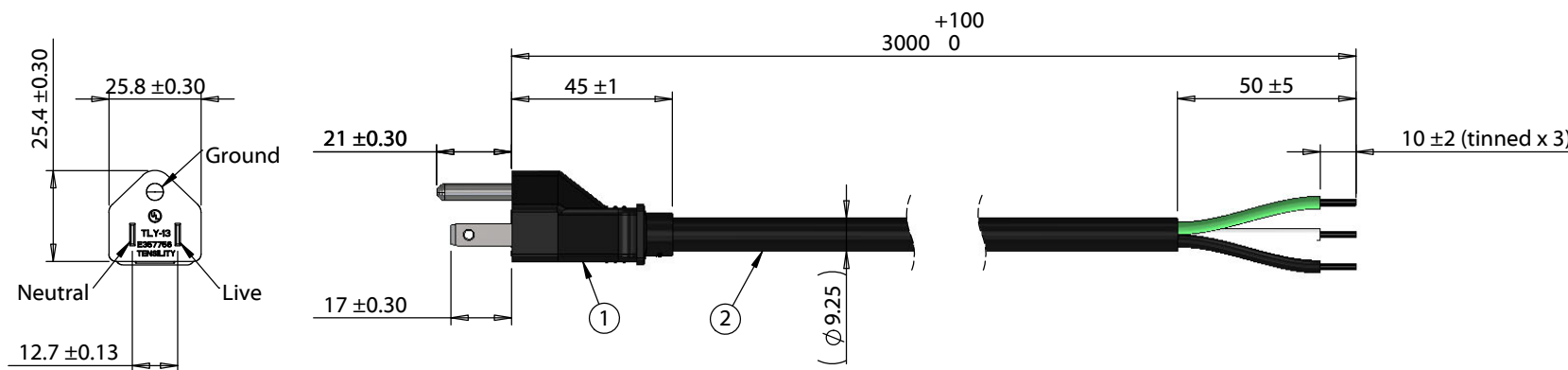

**Notes:**  
Cable rated for 18 A, 125 Vac

Wiring Diagram	
TLY-13	wire color
Live	black
Neutral	white
Ground	green

Revision:	Date:	Description:	Prepared:	Notes:	<h1>TENSILITY</h1> tel 1.541.323.3228 800 877.670.7118 fax 1.541.323.4202 web tensility.com
A	5/19/2020	Initial release	AG <small>Digitally signed by AG Date: 2020.05.19 10:19:23 -07'00'</small>		
			Verified:	Function test: no open, no short circuit, no intermittent	Size:
			AW <small>Digitally signed by AW Date: 2020.05.20 16:21:05 -07'00'</small>	Description:	A
			Dimensions are in millimeters. Tolerances: X: ± 0.5 mm X.X: ± 0.3 mm X.XX: ± 0.05 mm	Ac cord, 3000 mm, U.S., Nema 5-15P plug, TLY-13 to 10 mm tinned, 14 AWG, SJT wire, 30-01362	Part number: 11-00122
					Scale: 1:2
					Sheet 1 of 1

5

4

3

2

1