

SHAPE OF 4CKTS

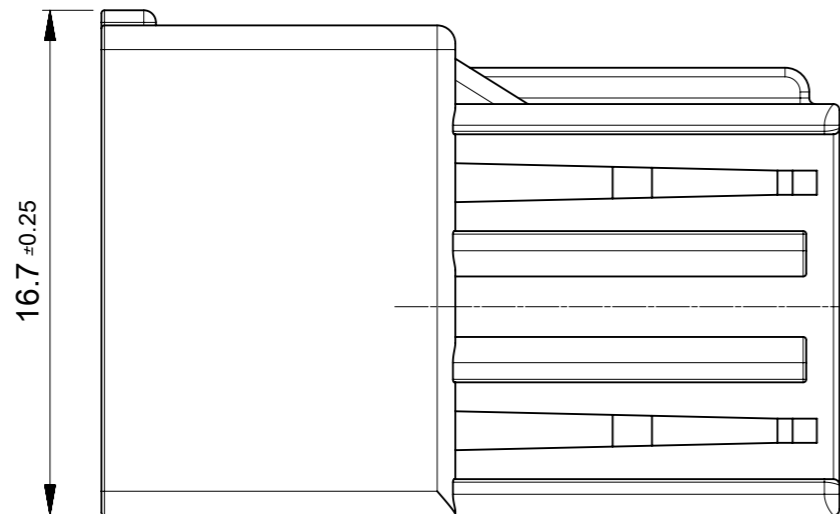

ターミナル嵌合状態図
TERMINAL MATING DRAWING

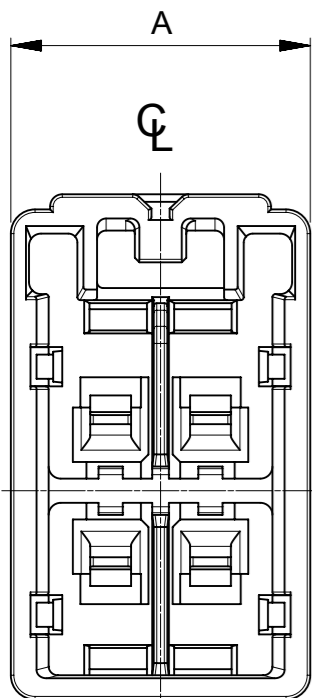
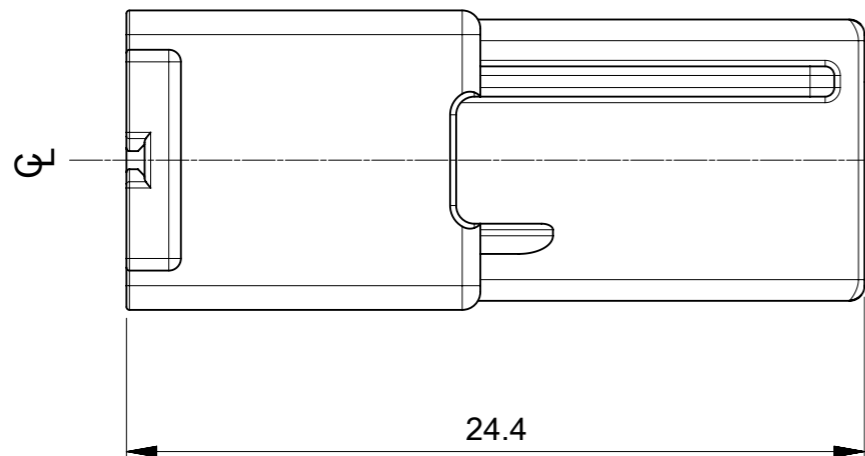
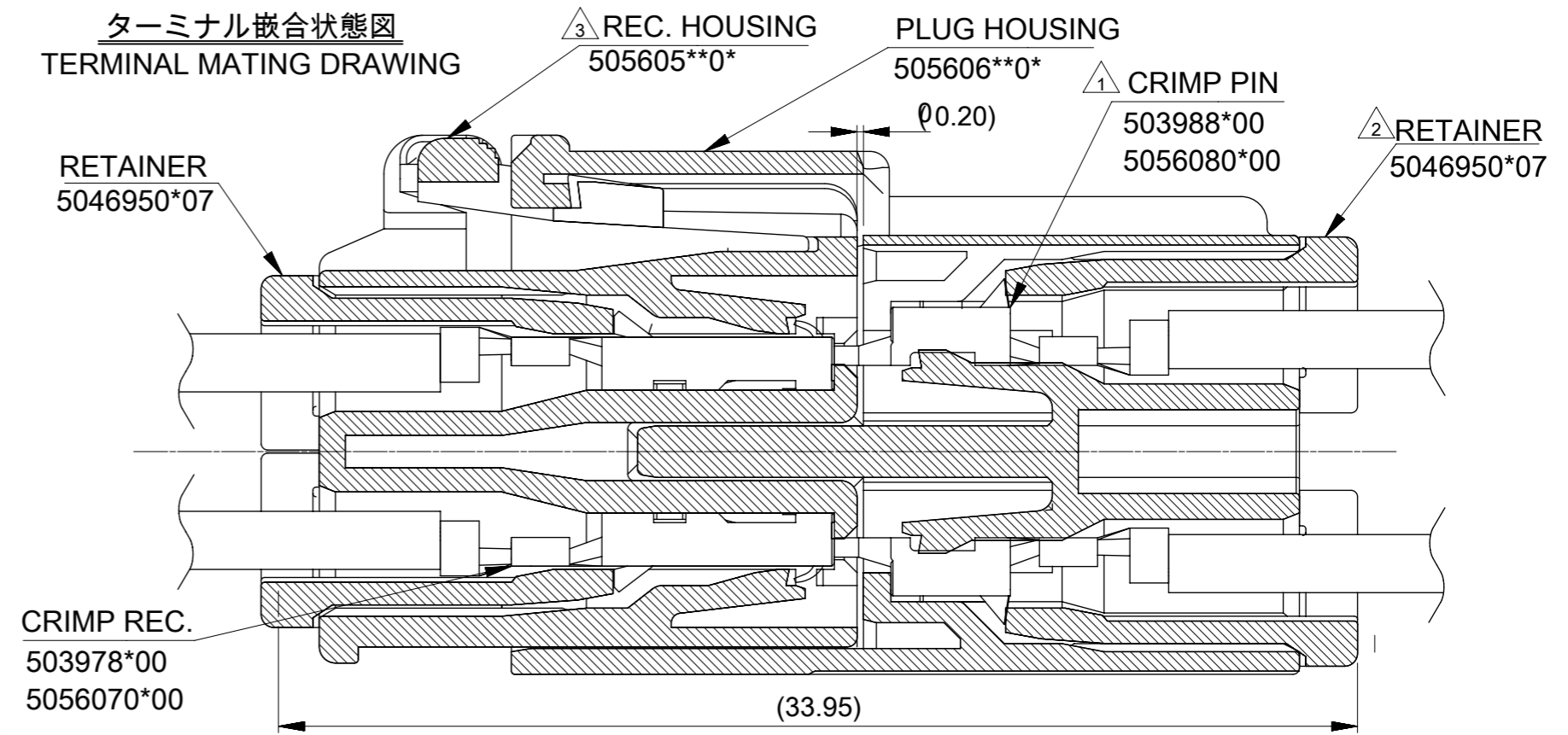

注記
NOTES

- ① 適合ターミナル:50398,505608 シリーズ。
APPLICABLE TERMINAL: 50398,505608 SERIES.
- ② 適合リテーナー : 504695 シリーズ。
APPLICABLE RETAINER:504695 SERIES.
- ③ 嵌合相手:505605 シリーズ。
MATE WITH : 505605 SERIES.
- 4. 材質 : POLYESTER(PBT),UL94V-0
MATERIAL:POLYESTER(PBT),UL94V-0

5. MATERIAL NO. は以下の内容を示す。
MATERIAL NO.

505606 **0*	色	
極数	CTK	COLOR
	0.	自然色 NATURAL
	1.	黒 BLACK
	2.	赤 RED
	3.	黄 YELLOW

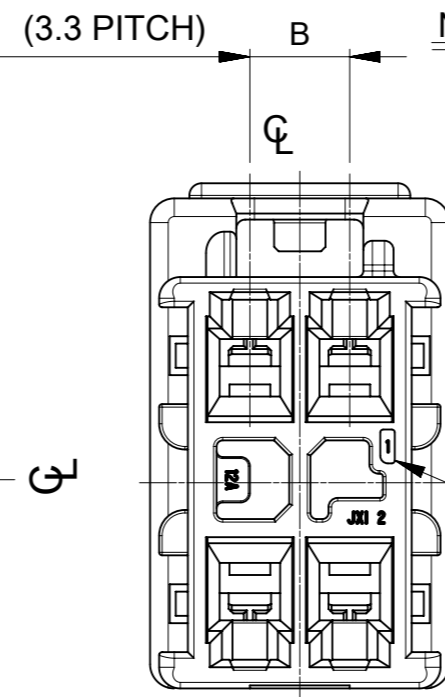

16.5	23.1	12	505606120*	505606**0*
13.2	19.8	10	505606100*	
9.9	16.5	8	505606080*	
6.6	13.2	6	505606060*	
3.3	9.9	4	505606040*	
(B)	A	極数 CTK.	BAG PACKAGE	MODEL NO.
			オーダー番号	ORDER NO.

THIS DRAWING CONTAINS INFORMATION THAT IS PROPRIETARY TO MOLEX ELECTRONIC TECHNOLOGIES, LLC AND SHOULD NOT BE USED WITHOUT WRITTEN PERMISSION

EC NO: 168281 DRWN: NITO CHK'D: SAKIYAMA APPR: TKANEKO	2017/11/21	2017/11/22	GENERAL TOLERANCES (UNLESS SPECIFIED) ANGULAR TOL ± 3.0 ° 4 PLACES ± 0.2 3 PLACES ± 0.2 2 PLACES ± 0.2 1 PLACE ± 0.2 0 PLACES ± 0.2 DRAFT WHERE APPLICABLE MUST REMAIN WITHIN DIMENSIONS	DIMENSION UNITS	SCALE	<p>CP 3.3 W/W DUAL ROW PLUG HOUSING</p> <p>PRODUCT CUSTOMER DRAWING</p>	
	DRWN BY	DATE		mm	4:1		
	QHE31	2016/11/01		CHK'D BY	DATE		
	SAKIYAMA	2017/02/08		APPR BY	DATE		
	TKANEKO	2017/02/08		DRAWING SIZE	THIRD ANGLE PROJECTION		
C	REV	A3		SERIES	MATERIAL NUMBER	CUSTOMER	
				505606	5056060000	GENERAL	
				DOCUMENT NUMBER	DOC TYPE	DOC PART	SHEET NUMBER
				5056060000	PSD	000	1 OF 2

MATING
KEY TYPE & COLOR

REFERENCE 4 CKTS

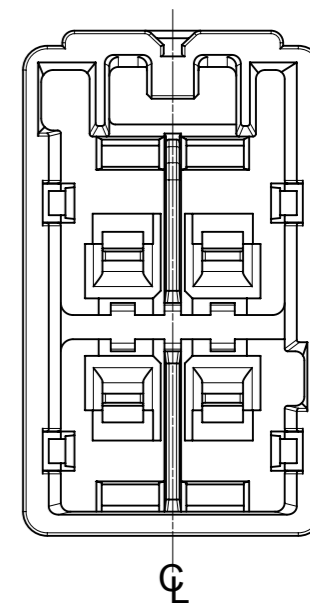
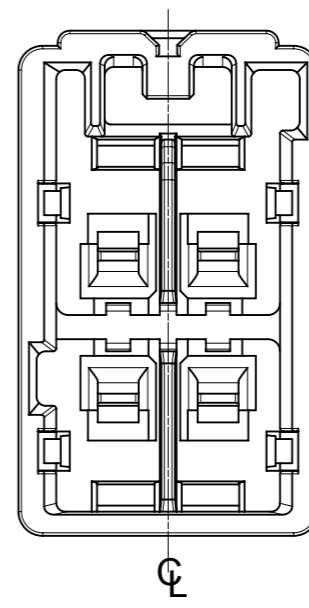
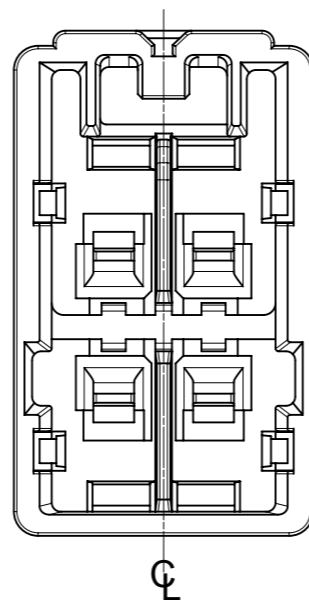
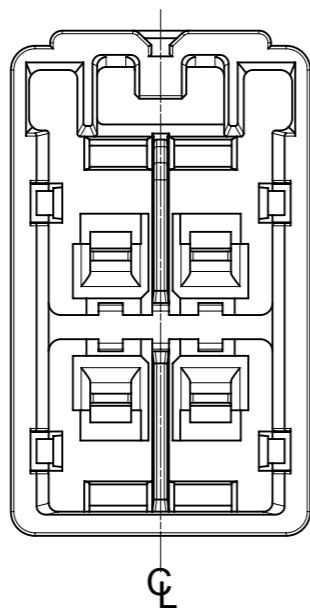

KEY TYPE : 1 COLOR : NATURAL
MATERIAL NO. : 5056060400

KEY TYPE : 2 COLOR : BLACK
MATERIAL NO. : 5056060401

KEY TYPE : 3 COLOR : RED
MATERIAL NO. : 5056060402

KEY TYPE : 4 COLOR : YELLOW
MATERIAL NO. : 5056060403

505605120*	5046950607	12	5056061203	5056061202	5056061201	5056061200
505605100*	5046950507	10	5056061003	5056061002	5056061001	5056061000
505605080*	5046950407	8	5056060803	5056060802	5056060801	5056060800
505605060*	5046950307	6	5056060603	5056060602	5056060601	5056060600
505605040*	5046950207	4	5056060403	5056060402	5056060401	5056060400
MATE WITH	CONFORTABLE-RETAINER	極数 CKT.	YELLOW	RED	BLACK	NATURAL
BAG PACKAGE						
オーダー番号 ORDER NO.						

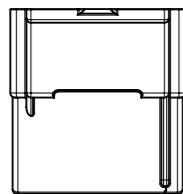
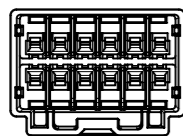

CKT1 MARK

VIEW OF 4,6,8,10,12CKTS
(SCALE 1:1)

THIS DRAWING CONTAINS INFORMATION THAT IS PROPRIETARY TO MOLEX ELECTRONIC TECHNOLOGIES, LLC AND SHOULD NOT BE USED WITHOUT WRITTEN PERMISSION

EC NO: 168281 DRWN: NITO CHK'D: SAKIYAMA APPR: TKANEKO	2017/11/21	GENERAL TOLERANCES (UNLESS SPECIFIED)	DIMENSION UNITS	SCALE	molex [®]			
	2017/11/22		mm	4:1				
			ANGULAR TOL ± 3.0 °	DRWN BY		DATE		
			4 PLACES ± 0.2	QHE31		2016/11/01		
	3 PLACES ± 0.2		CHK'D BY	DATE	CP 3.3 W/W DUAL ROW PLUG HOUSING			
	2 PLACES ± 0.2		SAKIYAMA	2017/02/08				
	1 PLACE ± 0.2		APPR BY	DATE	PRODUCT CUSTOMER DRAWING			
	0 PLACES ± 0.2		TKANEKO	2017/02/08				
	DRAFT WHERE APPLICABLE MUST REMAIN WITHIN DIMENSIONS		DRAWING SIZE	THIRD ANGLE PROJECTION	SERIES	MATERIAL NUMBER	CUSTOMER	
			A3		505606	5056060000	GENERAL	
					DOCUMENT NUMBER	DOC TYPE	DOC PART	SHEET NUMBER
					5056060000	PSD	000	2 OF 2