



LED Display Product Data Sheet LTC-2721E

Spec No.: DS-30-95-189

Effective Date: 07/20/2000

Revision: -

LITE-ON DCC

RELEASE

BNS-OD-FC001/A4

FEATURES

- * 0.28 inch (7.0 mm) DIGIT HEIGHT.
- * CONTINUOUS UNIFORM SEGMENTS.
- * LOW POWER REQUIREMENT.
- * EXCELLENT CHARACTERS APPEARANCE.
- * HIGH BRIGHTNESS & HIGH CONTRAST.
- * WIDE VIEWING ANGLE.
- * SOLID STATE RELIABILITY.
- * CATEGORIZED FOR LUMINOUS INTENSITY.

DESCRIPTION

The LTC-2721E is a 0.28 inch (7.0 mm) digit height triple digit seven-segment display. This device utilizes red orange LED chips, which are made from GaAsP on a transparent GaP substrate, and has a gray face and white segments.

DEVICE

| PART NO. | DESCRIPTION |
|-----------------|--|
| Red Orange | Multiplex Common Cathode Rt. Hand Decimal |
| LTC-2721E | |

PACKAGE DIMENSIONS

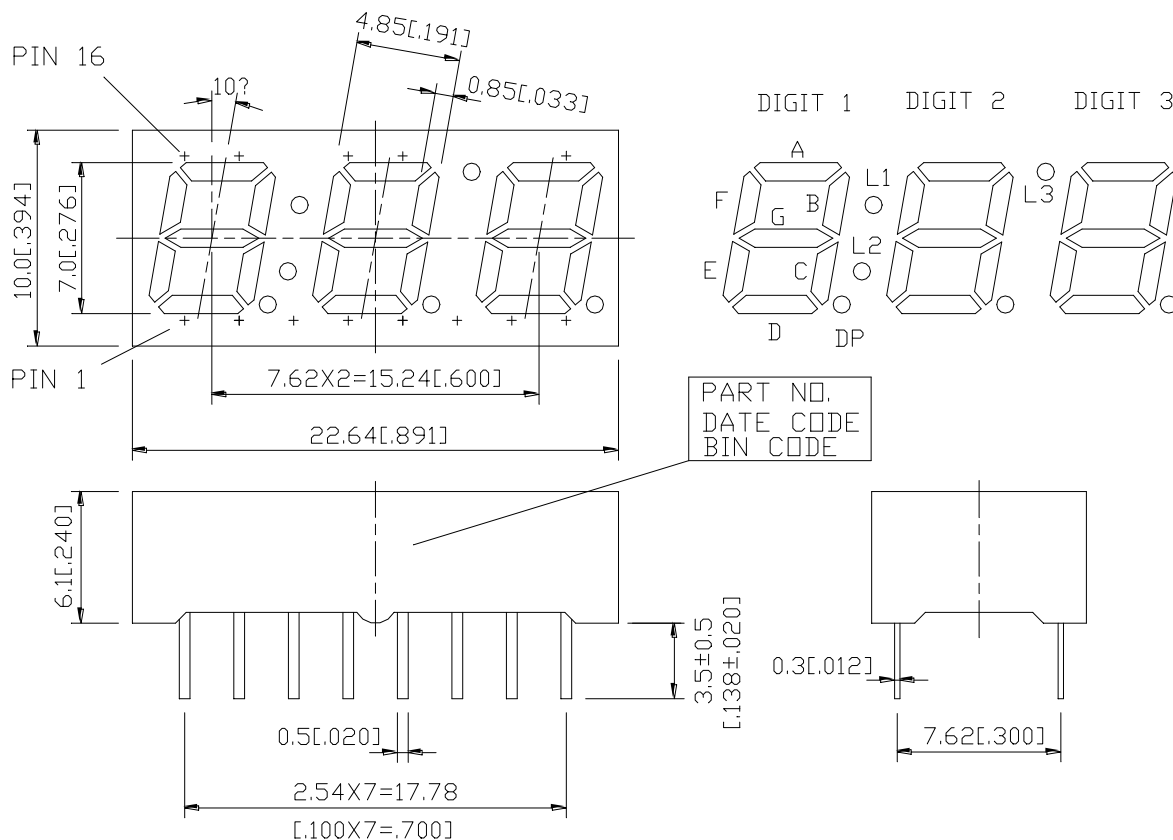

NOTES: All dimensions are in millimeters. Tolerances are ± 0.25 mm (0.01") unless otherwise noted.

INTERNAL CIRCUIT DIAGRAM

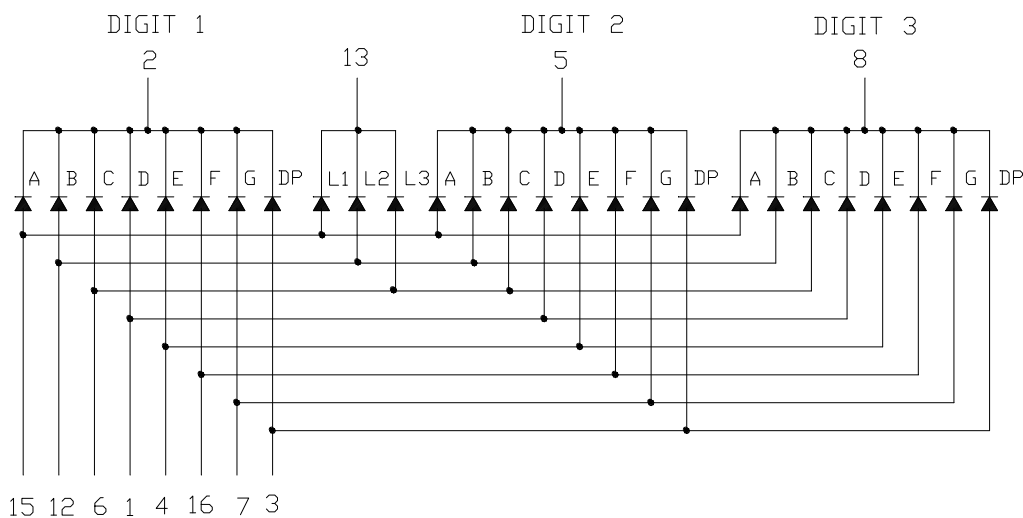

PIN CONNECTION

| NO | CONNECTION |
|----|-------------------------|
| 1 | ANODE D |
| 2 | COMMON CATHODE DIGIT 1 |
| 3 | ANODE DP |
| 4 | ANODE E |
| 5 | COMMON CATHODE DIGIT 2 |
| 6 | ANODE C |
| 7 | ANODE G |
| 8 | COMMON CATHODE DIGIT 3 |
| 9 | NO CONNECTION |
| 10 | NO PIN |
| 11 | NO PIN |
| 12 | ANODE B |
| 13 | COMMON CATHODE L1,L2,L3 |
| 14 | NO PIN |
| 15 | ANODE A |
| 16 | ANODE F |

ABSOLUTE MAXIMUM RATING AT Ta=25°C

| PARAMETER | MAXIMUM RATING | UNIT |
|---|----------------|-------------|
| Power Dissipation Per Segment | 75 | mW |
| Peak Forward Current Per Segment (1/10 Duty Cycle, 0.1ms Pulse Width) | 100 | mA |
| Continuous Forward Current Per Segment Derating Linear From 25°C Per Segment | 25 0.33 | mA mA/°C |
| Reverse Voltage Per Segment | 5 | V |
| Operating Temperature Range | -35°C to +85°C | |
| Storage Temperature Range | -35°C to +85°C | |
| Solder Temperature: max 260°C for max 3sec at 1.6mm below seating plane. | | |

ELECTRICAL / OPTICAL CHARACTERISTICS AT Ta=25°C

| PARAMETER | SYMBOL | MIN. | TYP. | MAX. | UNIT | TEST CONDITION |
|-----------------------------------|-------------------|------|------|------|------|----------------------|
| Average Luminous Intensity | I _v | 800 | 2000 | | μcd | I _F =10mA |
| Peak Emission Wavelength | λ _p | | 630 | | nm | I _F =20mA |
| Spectral Line Half-Width | Δλ | | 40 | | nm | I _F =20mA |
| Dominant Wavelength | λ _d | | 621 | | nm | I _F =20mA |
| Forward Voltage Per Segment | V _F | | 2.0 | 2.6 | V | I _F =20mA |
| Reverse Current Per Segment | I _R | | | 100 | μA | V _R =5V |
| Luminous Intensity Matching Ratio | I _v -m | | | 2:1 | | I _F =10mA |

Note: Luminous intensity is measured with a light sensor and filter combination that approximates the CIE (Commission Internationale De L'Eclairage) eye-response curve.

TYPICAL ELECTRICAL / OPTICAL CHARACTERISTIC CURVES

(25°C Ambient Temperature Unless Otherwise Noted)

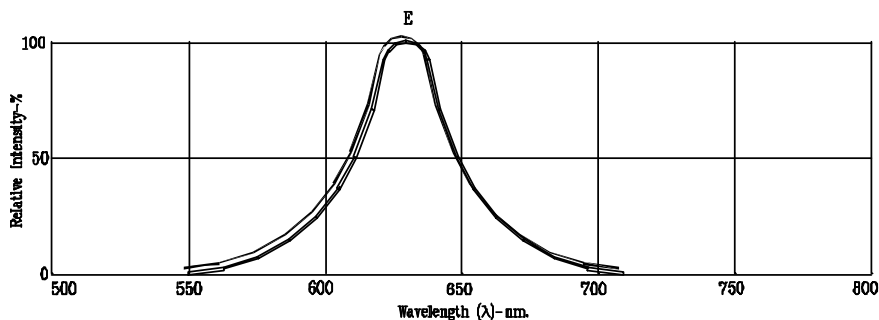

Fig.1. RELATIVE INTENSITY VS. WAVELENGTH

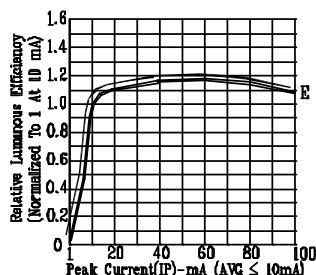

Fig.2. RELATIVE LUMINOUS EFFICIENCY (LUMINOUS INTENSITY PER UNIT CURRENT) VS. PEAK CURRENT (REFRESH RATE 1KHz)

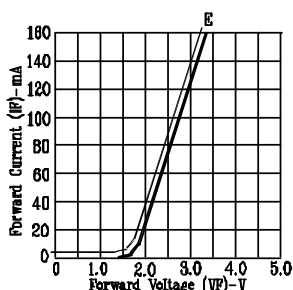

Fig.3. FORWARD CURRENT VS. FORWARD VOLTAGE

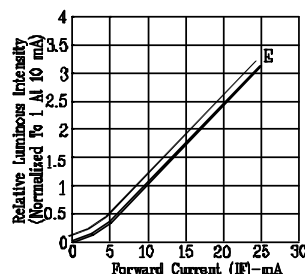

Fig.4. RELATIVE LUMINOUS INTENSITY VS. FORWARD CURRENT

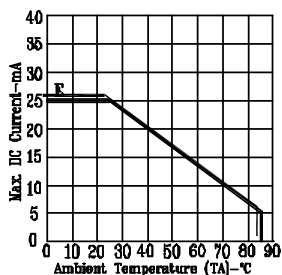

Fig.5. MAX ALLOWABLE DC CURRENT VS. AMBIENT TEMPERATURE

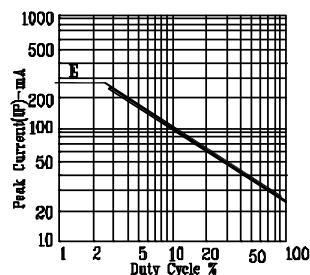

Fig.6. MAX PEAK CURRENT VS. DUTY CYCLE % (REFRESH RATE 1KHz)

NOTE: E=RED ORANGE