

VARIOSUB D-SUB 25

Contact Inserts, Sleeve Housings

Introduction

VARIOSUB is a range of plug connectors specially designed for signal and data technology in an industrial environment with high degrees of protection, temperatures and mechanical stress. The range is characterized by the simple Push-Pull locking mechanism, use of conventional D-SUB contact inserts, IP 67 protection and EMC protection.

The VARIOSUB housings offer the space and time-saving Push-Pull locking, which snaps in with a noticeable click. Two integrated lamellar cable screw connections for cable diameters of 5 - 13 mm provide high cable strain relief.

When locked, the housings fulfill the requirements of IP 67 protection, and require only little operating force thanks to a special profile gasket.

Red snap-in profiles offer up to 16 coding possibilities to avoid incorrect plugging. Marker labeling is also provided for. An internal metal sleeve and shroud on the panel mounting base provide optional EMC protection. Simple logistics due to the small number of individual components and high functionality of the housings help to save costs and increase availability. Mounting flanges on the panel mounting base accept the contact inserts. This allows internal and external wall mounting of the contact inserts.

The male and female inserts in D-SUB 25 format enable 25 data lines up to 0.35 mm^2 conductor cross section or 15 lines with 0.5 mm^2 conductor cross section to be connected. The connection points are clearly numbered. This facilitates any start-up under field conditions.

Industrial connectors are available for the sleeve and mounting side. They are made with screw connection, for soldering onto printed circuit boards, with a flat-ribbon cable connection and for crimp contacts. For currents up to 40 A or in combination with signal lines, two versions are available as male and female connectors. The use of these plug connectors saves space on the inside of the device. The contacts are equipped with U-grooves for manual solder connection and cover the maximum possible cross section range.



VARIOSUB D-SUB 25

Contact Inserts

Screw Connection



Description	Type	Order No.	Pcs./Pkt.
Male contact inserts, with PCB and 25 x MPT 0,5 screw connections	VS-25-ST-DSUB/25-MPT-0,5	16 89 78 9	10
Female contact inserts, with PCB and 25 x MPT 0,5 screw connections	VS-25-BU-DSUB/25-MPT-0,5	16 89 77 6	10
Technical data			
Mechanical data			
Insertion force per signal contact	[N]	≤ 3.3	
Extraction force per signal contact	[N]	≤ 2.2	
Insertion/withdrawal cycles		≥ 200	
Material and surfaces			
Insulating body		PBTP	
Contact material		Cu alloy	
Contact surface		Ni/Au	
Electrical data			
Max. amperage	[A]	1	
Operating voltage	[V]	63	
Contact resistance per contact pair	[mΩ]	≤ 2.5	
Insulation resistance	[MΩ]	≥ 5000	
Thermal and climatic data			
Temperature range	[°C]	- 20 to + 70	

VARIOSUB D-SUB 25
Contact Inserts
Solder Connection



Description	Type	Order No.	Pcs./Pkt.
Male contact inserts, solder connection, 25-pos., with straight solder pins, with hole	VS-25-ST-DSUB-EG	16 89 89 9	10
Female contact inserts, solder connection, 25-pos., with straight solder pins, with hole	VS-25-BU-DSUB-EG	16 89 90 9	10
Male contact inserts, solder connection, 25-pos., with angled solder pins, with thread	VS-25-ST-DSUB-ER	16 89 87 3	10
Female contact inserts, solder connection, 25-pos., with angled solder pins, with thread	VS-25-BU-DSUB-ER	16 89 88 6	10
Technical data			
Mechanical data			
Insertion force per signal contact	[N]	≤ 3.3	
Extraction force per signal contact	[N]	≤ 2.2	
Insertion/withdrawal cycles		≥ 200	
Material and surfaces			
Insulating body		PBTP	
Contact material		Cu alloy	
Contact surface		Ni/Au	
Electrical data			
Max. amperage	[A]	1	
Operating voltage	[V]	63	
Contact resistance per contact pair	[mΩ]	≤ 2.5	
Insulation resistance	[MΩ]	≥ 5000	
Thermal and climatic data			
Temperature range	[°C]	- 55 to + 125	

VARIOSUB D-SUB 25

Contact Inserts

Flat-Ribbon Cable Connection



Description	Type	Order No.	Pcs./Pkt.
Male contact inserts, flat-ribbon cable connection, 25-pos., with holes	VS-25-ST-DSUB-FK	16 89 91 2	10
Female contact inserts, flat-ribbon cable connection, 25-pos., with holes	VS-25-BU-DSUB-FK	16 89 92 5	10
Technical data			
Mechanical data			
Insertion force per signal contact	[N]	≤ 3.3	
Extraction force per signal contact	[N]	≤ 2.2	
Insertion/withdrawal cycles		≥ 200	
Material and surfaces			
Insulating body		PBTP	
Contact material		Cu alloy	
Contact surface		Ni/Au	
Electrical data			
Max. amperage	[A]	1	
Operating voltage	[V]	63	
Contact resistance per contact pair	[mΩ]	≤ 2.5	
Insulation resistance	[MΩ]	≥ 5000	
Thermal and climatic data			
Temperature range	[°C]	- 55 to + 125	

VARIOSUB D-SUB 25

Contact Inserts

Crimp Connection



Description	Type	Order No.	Pcs./Pkt.
Male contact carrier, crimp contact carriers, 25-pos., with thread	VS-25-ST-DSUB-CD-G	16 89 93 8	10
Female contact carrier, crimp contact carriers, 25-pos., with thread	VS-25-BU-DSUB-CD-G	16 89 94 1	10
Male contact carrier, crimp contact carriers, 25-pos., with holes	VS-25-ST-DSUB-CD-B	16 89 95 4	10
Female contact carrier, crimp contact carriers, 25-pos., with holes	VS-25-BU-DSUB-CD-B	16 89 96 7	10
Accessories			
Turned male crimp contacts, surface gold-plated	AWG 24-20	VS-ST-CD-1,0/14,8/0,5	16 88 96 8 16 88 97 1
	AWG 28-24	VS-ST-CD-1,0/14,8/0,2	
Turned female crimp contacts, surface gold-plated	AWG 24-20	VS-BU-CD-1,0/14,4/0,5	16 88 98 4 16 88 99 7
	AWG 28-24	VS-BU-CD-1,0/14,4/0,2	
Technical data			
Mechanical data			
Insertion force per signal contact	[N]	≤ 3.3	
Extraction force per signal contact	[N]	≤ 2.2	
Insertion/withdrawal cycles		≥ 200	
Electrical data			
Max. amperage	[A]	1	
Operating voltage	[V]	63	
Insulation resistance	[MΩ]	≥ 5000	
Thermal and climatic data			
Temperature range	[°C]	- 55 to + 125	

VARIOSUB D-SUB 25

Contact Inserts with High Current Contacts Solder Connection



Description	Type	Order No.	Pcs./Pkt.
Male contact carrier, for power contacts, 5-pos.	VS-25-ST-DSUB-5P	16 89 97 0	10
Female contact carrier, for power contacts, 5-pos.	VS-25-BU-DSUB-5P	16 89 98 3	10
Accessories			
Male power contact for 20 A, with U-groove solder connection	VS-ST-LK-3,6/22,4/2,6	16 88 24 3	30
Female power contact for 20 A, with U-groove solder connection	VS-BU-LK-3,6/22,8/2,6	16 88 25 6	30
Male power contact for 40 A, with U-groove solder connection	VS-ST-LK-3,6/22,4/4,6	16 88 26 9	30
Female power contact for 40 A, with U-groove solder connection	VS-BU-LK-3,6/22,8/4,6	16 88 27 2	30
Technical data			
Mechanical data			
Insertion/withdrawal cycles		≥ 500	
Material and surfaces			
Insulating body		PBTP GV (UL 94 V0)	
Housing		Steel	
Housing surface		Tin-plated	
Contact material		Cu alloy	
Contact surface		0.8 µm gold over nickel	
Electrical data			
Max. amperage, power contacts	[A]	20 or 40	
Operating voltage	[V]	125	
Contact resistance per contact pair	[mΩ]	≤ 2.5	
Insulation resistance	[MΩ]	≥ 5000	
Specific contact resistance	[Ωcm]	10 ¹⁶	
Specific internal insulation resistance	[KV/mm]	50	
Thermal and climatic data			
Temperature range	[°C]	- 20 to + 80	

Note:

The power contacts must be ordered separately since they are not included in the scope of supply of the contact carriers of combi contact inserts.

VARIOSUB D-SUB 25

Contact Inserts with High Current and Signal Contacts

Solder Connection



Description	Type	Order No.	Pcs./Pkt.
Male contact carrier, for 3 power contacts, with 10 signal contacts, U-groove solder connection	VS-25-ST-DSUB-3P-10S	16 89 99 6	10
Female contact carrier, for 3 power contacts, with 10 signal contacts, U-groove solder connection	VS-25-BU-DSUB-3P-10S	16 90 00 8	10
Accessories			
Male power contact for 20 A, with U-groove solder connection	VS-ST-LK-3,6/22,4/2,6	16 88 24 3	30
Female power contact for 20 A, with U-groove solder connection	VS-BU-LK-3,6/22,8/2,6	16 88 25 6	30
Male power contact for 40 A, with U-groove solder connection	VS-ST-LK-3,6/22,4/4,6	16 88 26 9	30
Female power contact for 40 A, with U-groove solder connection	VS-BU-LK-3,6/22,8/4,6	16 88 27 2	30
Technical data			
Mechanical data			
Insertion/withdrawal cycles		≥ 500	
Material and surfaces			
Insulating body		PBTP GV (UL 94 V0)	
Housing		Steel	
Housing surface		Tin-plated	
Contact material		Cu alloy	
Contact surface		0.8 µm gold over nickel	
Electrical data			
Max. amperage, signal contacts	[A]	5	
Max. amperage, power contacts	[A]	20 or 40	
Operating voltage	[V]	125	
Thermal and climatic data			
Temperature range	[°C]	- 20 to + 80	

Note:
The power contacts must be ordered separately since they are not included in the scope of supply of the contact carriers of combi contact inserts.

VARIOSUB D-SUB 25 Sleeve Housings



Description	Type	Order No.	Pcs./Pkt.
<p>Plastic sleeve housing, with Push-Pull locking for panel mounting base, with 2 inclined M 20 lamellar screw connections, with 2 screws for fastening the contact inserts</p>	VS-25-T-2 M20	16 89 79 2	5
Accessories			
<p>M 20 cap nut with seal for conductor diameters from 5-13 mm</p>	VS-M20 (5-13)	16 52 12 7	5
<p>Cover cap, for vacant M 20 screw connections</p>	VC-PG 11 BS	16 88 14 6	10
<p>Coding profile, made of red plastic, mounted in the panel mounting base and sleeve housing (4 profiles for each plug connector) see Fig. 1</p>	CP-HCC 4	16 00 02 7	100
<p>Marker labels, for snapping in</p>	ZBN 18: UNBEDRUCKT	28 09 12 8	10
<p>EMC internal sleeve, with connection clamp and screw for contacting 2 conductor screens</p>	VS-25-TI-2EMV	16 89 80 2	5
<p>Protective cover, for covering the contact insert in the panel mounting frame or sleeve housing</p>	VS-25-SD	16 52 21 1	5
Technical data			
Insulation material		PA	
Inflammability class acc. to UL 94		V0	
Degree of protection		IP 67	
Temperature range	[°C]	- 20 to + 80	

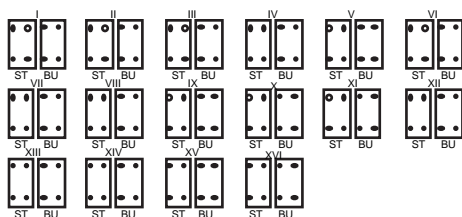
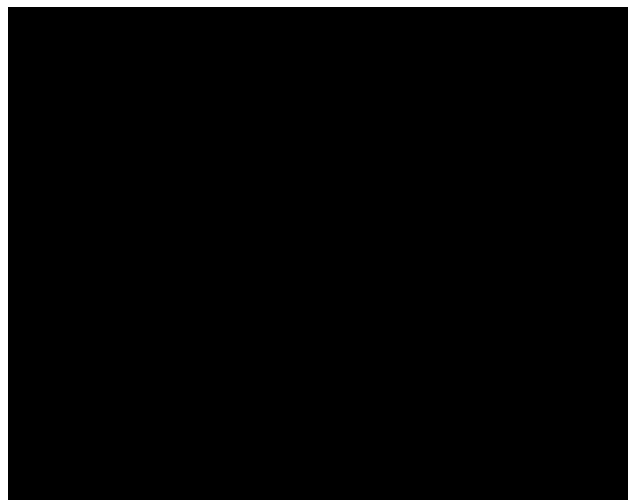

Figure 1: Coding for housings with one contact insert



VS-25-T-2 M20

VARIOSUB D-SUB 25 Panel Mounting Frames



Description	Type	Order No.	Pcs./Pkt.
Plastic panel mounting frame, with radially-acting profile gasket mounted, with enclosed self-adhesive flat gasket (without mounting screws on the device side)	VS-25-A	16 89 75 0	5
Accessories			
EMC shroud, for contacting a D-SUB contact insert on the mounting side with the outer wall of the housing	VS-25-A-EMV-S	16 89 76 3	5
Protective cover, for covering the contact insert in the panel mounting frame or sleeve housing	VS-25-SD	16 52 21 1	5
Technical data			
Insulation material	PA		
Inflammability class acc. to UL 94	V0		
Degree of protection	IP 67		
Temperature range	- 20 to + 80		
	[°C]		

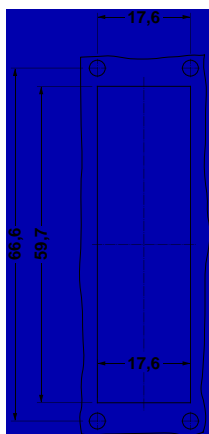

Panel cutout: VS-25-A

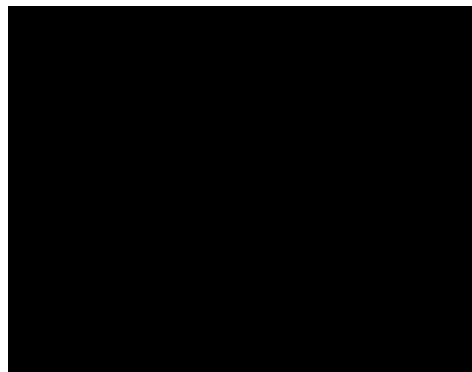

Dimensional drawing: VS-25-A

VARIOSUB D-SUB 25

Panel Mounting Frames with Gender Changer



The illustration shows the 9-pos. version

Description		Type	Order No.	Pcs./Pkt.
Panel mounting frame, with gender changer	Female / Female	VS-25-A-GC-BU/BU	16 89 73 4	5
Panel mounting frame, with gender changer	Male / Male	VS-25-A-GC-ST/ST	16 89 74 7	5
Technical data				
Insulation material			PA	
Inflammability class acc. to UL 94			V0	
Degree of protection			IP 67	
Temperature range	[°C]		- 20 to + 80	

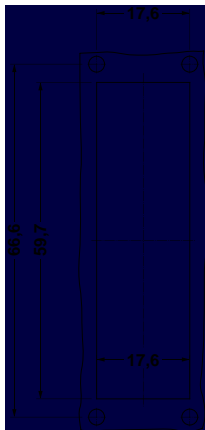

Panel cutout: VS-25-A-GC...

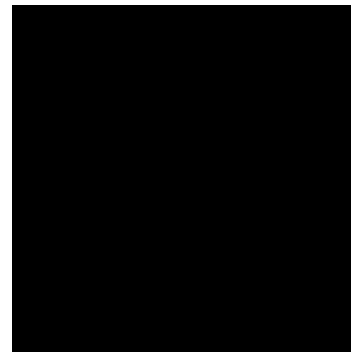

	VS-25-A-GC...
A [mm]	76.0
B [mm]	66.6

Dimensional drawing: VS-25-A-GC...

VARIOSUB D-SUB 25 Couplings



The illustration shows the 9-pos. version

Description	Type	Order No.	Pcs./Pkt.
Coupling, 25-pos., Female / Female	VS-25-KU-BU/BU	16 89 67 9	5
Coupling, 25-pos., Male / Male	VS-25-KU-ST/ST	16 89 68 2	5
Technical data			
Insulation material		PA	
Inflammability class acc. to UL 94		V0	
Degree of protection		IP 67	
Temperature range	[°C]	- 20 to + 80	

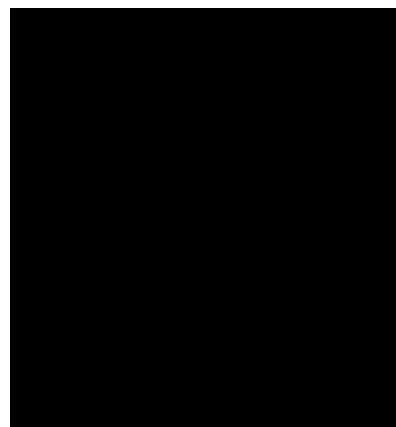

	VS-25-KU...
A [mm]	76.0

Dimensional drawing: VS-25-KU...

VIARIOSUB D-SUB 25 Plug Connector Sets



Description

Set VIARIOSUB D-SUB 25, standard version
for D-SUB 25 contact inserts, with Push-Pull locking, IP 67

Set VIARIOSUB D-SUB 25, EMC version
for D-SUB 25 contact inserts, with Push-Pull locking, IP 67

Accessories

Protective cover,
for covering the contact insert in the panel mounting frame or sleeve housing

Technical data

Insulation material

Inflammability class acc. to UL 94

Degree of protection

Temperature range

[°C]

Type

Order No.

Pcs./Pkt.

VS-25-SET-STD

16 52 19 8

1

VS-25-SET-EMV

16 52 20 8

1

VS-25-SD

16 52 21 1

5

PA

V0

IP 67

- 20 to + 80



Panel cutout of panel mounting frame

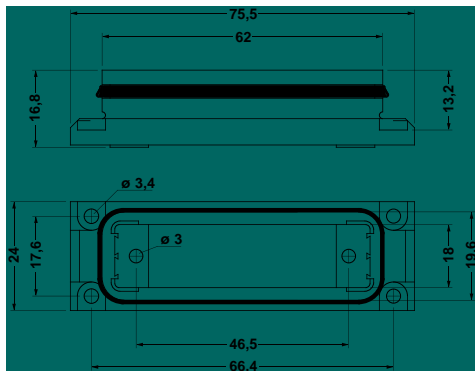

Dimensional drawing of panel mounting frame

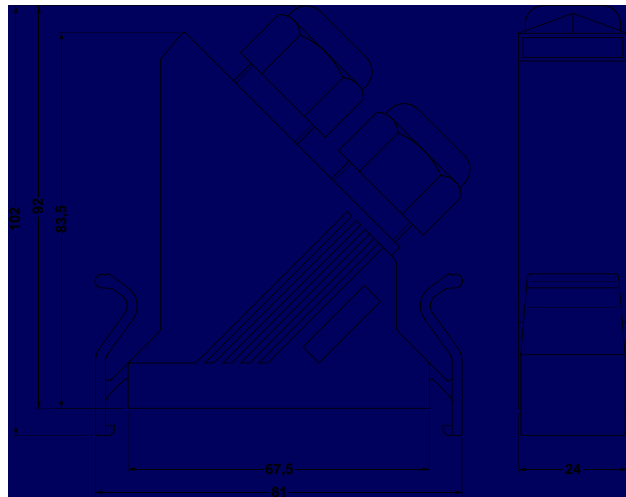

Dimensional drawing of sleeve