

SFP-16GB-DW41-40-C

MSA and TAA 16GBase-DWDM FC SFP+ Transceiver Channel DW41 100GHz (SMF, 1544.53nm, 40km, LC, DOM, 0 to 70C)

Features:

- SFF-8432 and SFF-8472 Compliance
- Duplex LC Connector
- Cooled EML transmitter and PIN receiver
- Single-mode Fiber
- Commercial Temperature 0 to 70 Celsius
- Hot Pluggable
- Metal with Lower EMI
- Excellent ESD Protection
- RoHS Compliant and Lead Free



Applications:

- 16x Gigabit Ethernet over DWDM
- 8x/10x Fibre Channel
- Access, Metro and Enterprise

Product Description

This MSA Compliant SFP+ transceiver provides 16GBase-DWDM Fibre Channel throughput up to 40km over single-mode fiber (SMF) using a wavelength of 1544.53nm via an LC connector. It is built to MSA standards and is uniquely serialized and data-traffic and application tested to ensure that they will integrate into your network seamlessly. Digital optical monitoring (DOM) support is also present to allow access to real-time operating parameters. This transceiver is Trade Agreements Act (TAA) compliant. We stand behind the quality of our products and proudly offer a limited lifetime warranty.

ProLabs' transceivers are RoHS compliant and lead-free.

TAA refers to the Trade Agreements Act (19 U.S.C. & 2501-2581), which is intended to foster fair and open international trade. TAA requires that the U.S. Government may acquire only "U.S. – made or designated country end products."



Regulatory Compliance

- ESD to the Electrical PINs: compatible with MIL-STD-883E Method 3015.4.
- ESD to the LC Receptacle: compatible with IEC 61000-4-3.
- EMI/EMC: compatible with FCC Part 15 Subpart B Rules, EN55022:2010.
- Laser Eye Safety: compatible with FDA 21CFR, EN60950-1& EN (IEC) 60825-1, 2.
- RoHS: compliant with EU RoHS 2.0 directive 2015/863/EU.

Wavelength Guide (100GHz ITU-T Channel)

| Channel # | Frequency (THz) | Center Wavelength (nm) |
|-----------|-----------------|------------------------|
| 17 | 191.7 | 1563.86 |
| 18 | 191.8 | 1563.05 |
| 19 | 191.9 | 1562.23 |
| 20 | 192.0 | 1561.42 |
| 21 | 192.1 | 1560.61 |
| 22 | 192.2 | 1559.79 |
| 23 | 192.3 | 1558.98 |
| 24 | 192.4 | 1558.17 |
| 25 | 192.5 | 1557.36 |
| 26 | 192.6 | 1556.55 |
| 27 | 192.7 | 1555.75 |
| 28 | 192.8 | 1554.94 |
| 29 | 192.9 | 1554.13 |
| 30 | 193.0 | 1553.33 |
| 31 | 193.1 | 1552.52 |
| 32 | 193.2 | 1551.72 |
| 33 | 193.3 | 1550.92 |
| 34 | 193.4 | 1550.12 |
| 35 | 193.5 | 1549.32 |
| 36 | 193.6 | 1548.51 |
| 37 | 193.7 | 1547.72 |
| 38 | 193.8 | 1546.92 |
| 39 | 193.9 | 1546.12 |
| 40 | 194.0 | 1545.32 |
| 41 | 194.1 | 1544.53 |
| 42 | 194.2 | 1543.73 |
| 43 | 194.3 | 1542.94 |
| 44 | 194.4 | 1542.14 |

| | | |
|----|-------|---------|
| 45 | 194.5 | 1541.35 |
| 46 | 194.6 | 1540.56 |
| 47 | 194.7 | 1539.77 |
| 48 | 194.8 | 1538.98 |
| 49 | 194.9 | 1538.19 |
| 50 | 195.0 | 1537.40 |
| 51 | 195.1 | 1536.61 |
| 52 | 195.2 | 1535.82 |
| 53 | 195.3 | 1535.04 |
| 54 | 195.4 | 1534.25 |
| 55 | 195.5 | 1533.47 |
| 56 | 195.6 | 1532.68 |
| 57 | 195.7 | 1531.90 |
| 58 | 195.8 | 1531.12 |
| 59 | 195.9 | 1530.33 |
| 60 | 196.0 | 1529.55 |
| 61 | 196.1 | 1528.77 |

Absolute Maximum Ratings

| Parameter | Symbol | Min. | Typ. | Max. | Unit | Notes |
|----------------------------|--------|------|--------|------|------|-------|
| Maximum Supply Voltage | Vcc | -0.5 | | 4.5 | V | |
| Storage Temperature | Tstg | -40 | | 85 | °C | |
| Operating Case Temperature | Tc | 0 | | 70 | °C | |
| Operating Humidity | RH | 5 | | 95 | % | |
| Data Rate | BR | 4.25 | 14.025 | | Gbps | |

Electrical Characteristics

| Parameter | Symbol | Min. | Typ. | Max. | Unit | Notes |
|--------------------------------|---------|-------|------|-------|----------|-------|
| Power Supply Voltage | Vcc | 3.135 | 3.30 | 3.465 | V | |
| Power Supply Current | Icc | | | 550 | mA | |
| Transmitter | | | | | | |
| Differential Data Input Swing | VIN | 180 | | 850 | mV | 1 |
| Input Differential Impedance | ZIN | 90 | 100 | 110 | Ω | |
| Tx_Disable | Disable | VIH | 2.0 | Vcc | V | |
| | Enable | VIL | 0 | 0.8 | V | |
| Tx_Fault | Fault | VOH | 2.0 | Vcc | V | |
| | Normal | VOL | 0 | 0.8 | V | |
| Receiver | | | | | | |
| Differential Data Output Swing | VOUT | 300 | | 900 | mV | 2 |
| LOS | High | 2.0 | | Vcc | V | |
| | Low | | | 0.8 | V | |

Notes:

1. PECL input. Internally AC-coupled and terminated.
2. Internally AC-coupled.

Optical Characteristics

| Parameter | Symbol | Min. | Typ. | Max. | Unit | Notes |
|-----------------------------|-----------------|---------|------|---------|------|-------|
| Transmitter | | | | | | |
| Center Wavelength | λ_C | 1528.77 | | 1563.86 | nm | |
| Spectral Width (-20dB) | $\Delta\lambda$ | | | 1 | nm | |
| Side-Mode Suppression Ratio | SMSR | 30 | | | dB | |
| Average Output Power | POUT | -1 | | 3 | dBm | 1 |
| Extinction Ratio | ER | 8.2 | | | dB | |
| Receiver | | | | | | |
| Center Wavelength | λ_C | 1260 | | 1620 | nm | |
| Receiver Sensitivity | S | | | -14 | dBm | 2 |
| Receiver Overload | POL | 0.5 | | | dBm | 2 |
| LOS De-Assert | LOSD | | | -15 | dBm | |
| LOS Assert | LOSA | -28 | | | dBm | |
| LOS Hysteresis | LOSH | 0.5 | | | dB | |

Notes:

1. The optical power is launched into the SMF.
2. Measured with a PRBS 2³¹-1 test pattern @14025Mbps, BER ≤1×10⁻¹².

Timing and Electrical Specifications

| Parameter | Symbol | Min. | Typ. | Max. | Unit |
|--|----------------|------|------|------|------|
| Tx_Negate Time | T_on | | | 2 | ms |
| Tx_Disable Assert Time | T_off | | | 100 | μs |
| Time To Initialize Including Reset of Tx_Fault | T_init | | | 300 | ms |
| Tx_Fault Assert Time | T_fault | | | 100 | μs |
| Tx_Disable To Reset | T_reset | 10 | | | μs |
| LOS Assert Time | T_loss_on | | | 100 | μs |
| LOS De-Assert Time | T_loss_off | | | 100 | μs |
| Serial ID Clock Rate | T_serial_clock | | 100 | 400 | KHz |
| MOD_DEF (0:2) - High | VOH | 2 | | Vcc | V |
| MOD_DEF (0:2) - Low | VOL | | | 0.8 | V |

Pin Descriptions

| Pin | Symbol | Name/Descriptions | Ref. |
|-----|------------|--|------|
| 1 | VeeT | Transmitter Ground (Common with Receiver Ground). | 1 |
| 2 | Tx_Fault | Transmitter Fault. LVTTTL-O. | 2 |
| 3 | Tx_Disable | Transmitter Disable. Laser output disabled on "high" or "open." LVTTT-I. | 3 |
| 4 | SDA | 2-Wire Serial Interface Data (Same as MOD-DEF2 in INF-8074i). LVTTTL-I/O. | |
| 5 | SCL | 2-Wire Serial Interface Clock (Same as MOD-DEF2 in INF-8074i). LVTTTL-I. | |
| 6 | MOD_ABS | Module Absent. Connect to VeeT or VeeR in the module. | 4 |
| 7 | RS0 | Rate Select 0. Not Used. | 5 |
| 8 | LOS | Loss of Signal Indication. "Logic 0" indicates normal operation. LVTTTL-O. | 2 |
| 9 | RS1 | Rate Select 1. Not Used. | 5 |
| 10 | VeeR | Receiver Ground (Common with Transmitter Ground). | 1 |
| 11 | VeeR | Receiver Ground (Common with Transmitter Ground). | 1 |
| 12 | RD- | Receiver Inverted Data Out. AC Coupled. CML-O. | |
| 13 | RD+ | Receiver Non-Inverted Data Out. AC Coupled. CML-O. | |
| 14 | VeeR | Receiver Ground (Common with Transmitter Ground). | 1 |
| 15 | VccR | Receiver Power Supply. | |
| 16 | VccT | Transmitter Power Supply. | |

| | | | |
|----|------|--|---|
| 17 | VeeT | Transmitter Ground (Common with Receiver Ground). | 1 |
| 18 | TD+ | Transmitter Non-Inverted Data In. AC Coupled. CML-I. | |
| 19 | TD- | Transmitter Inverted Data In. AC Coupled. CML-O. | |
| 20 | VeeT | Transmitter Ground (Common with Receiver Ground). | 1 |

Notes:

1. The module signal ground contacts, VeeR and VeeT, should be isolated from the module case.
2. This contact is an open collector/drain output and should be pulled up to the Host_Vcc with resistor in the range 4.7kΩ to 10kΩ. Pull-ups can be connected to one or several power supplies; however, the host board design shall ensure that no module contract has voltage exceeding module VccT/R+0.5V.
3. Tx_Disable is an input contact with a 4.7kΩ to 10kΩ pull-up resistor to VccT inside the module.
4. MOD_ABS is connected to VeeT or VeeR in the SFP+ module. The host may pull the contract up to Host_Vcc with a resistor in the range from 4.7kΩ to 10kΩ. MOD_ABS is asserted “High” when the SFP+ module is physically absent from a host slot.
5. Internally pulled down per SFF-8431.

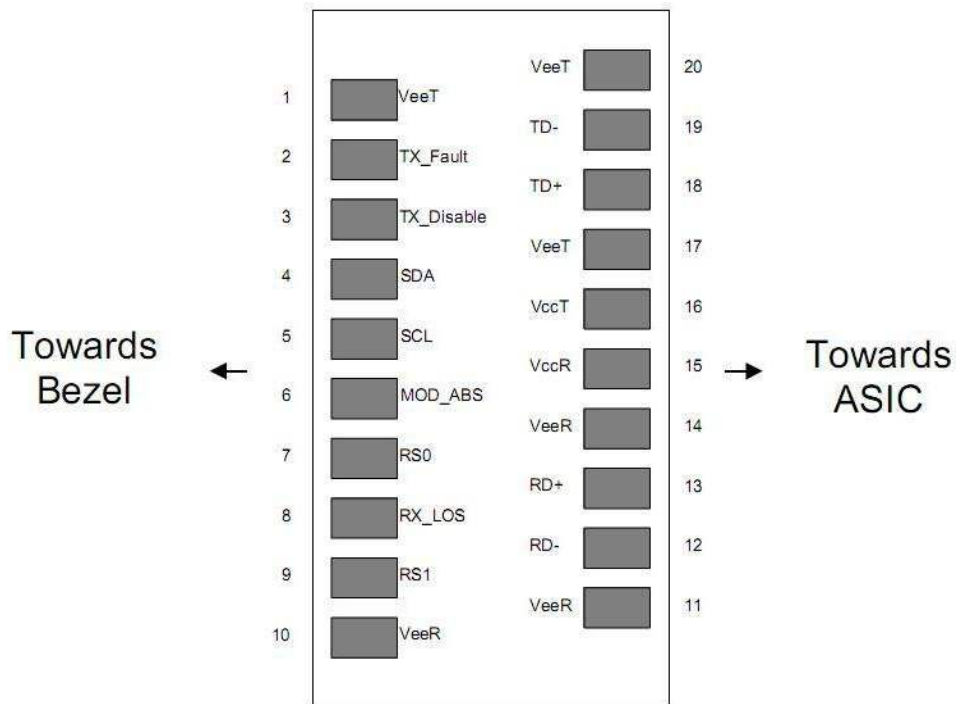

Pin-Out of Connector Block on the Host Board

Transceiver Functional Diagram

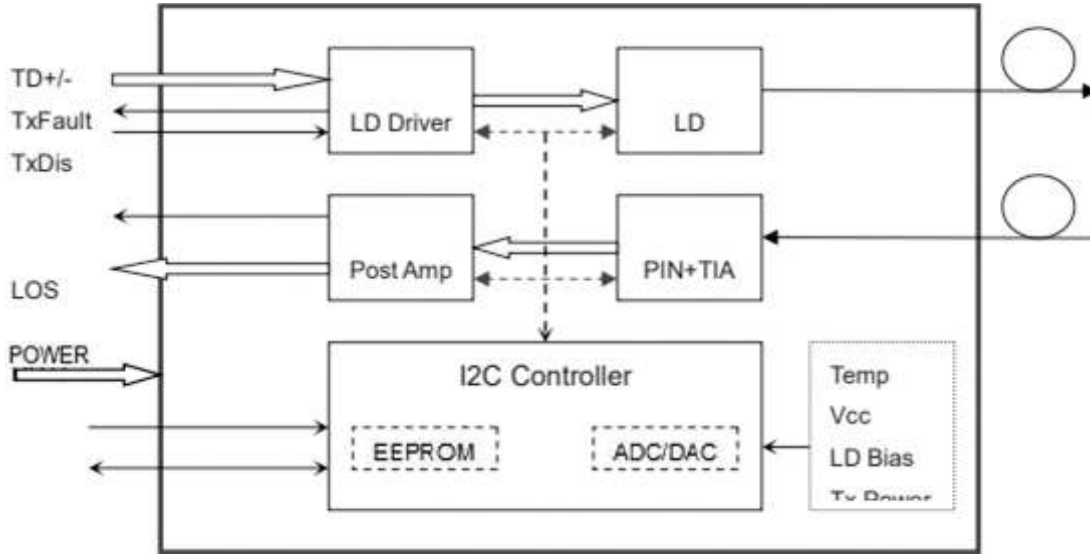

Recommended Interface Circuit Schematic



Mechanical Specifications

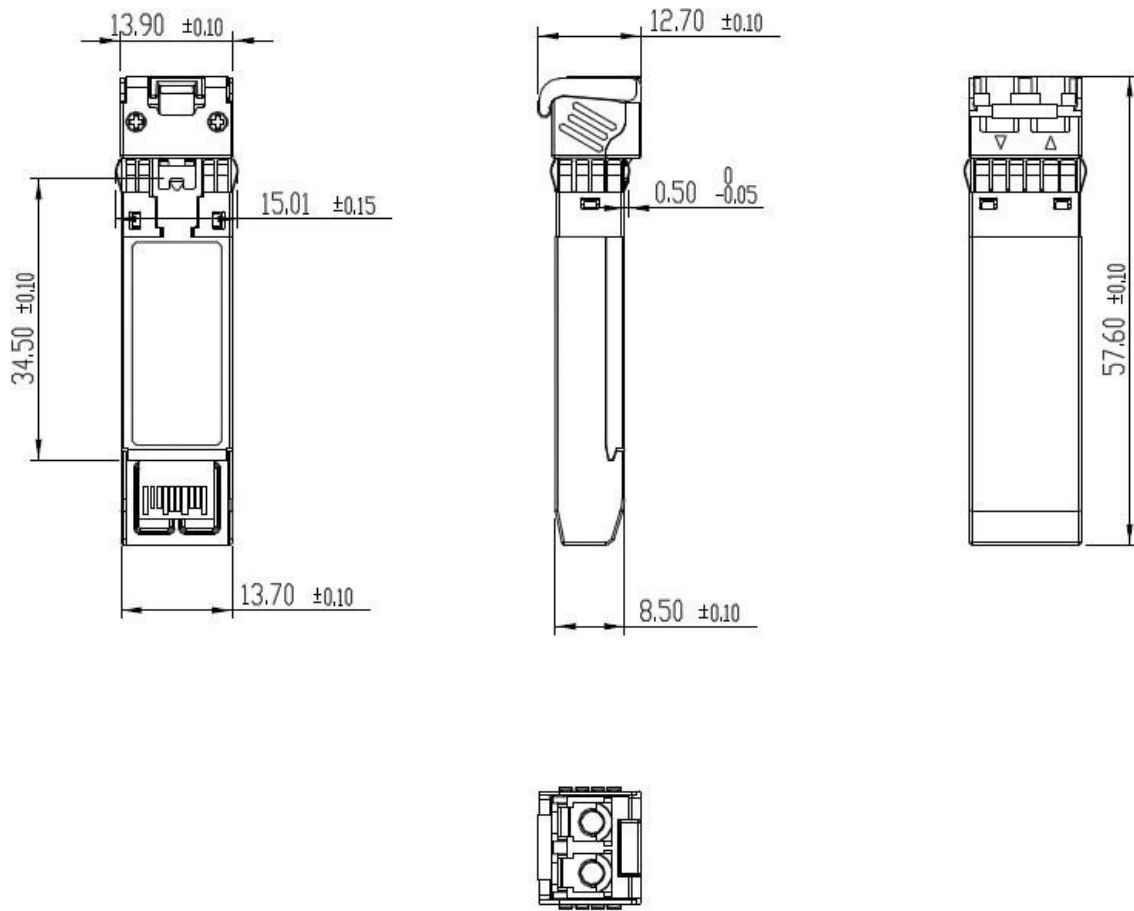

EEPROM Information

EEPROM memory map-specific data field description is as below:

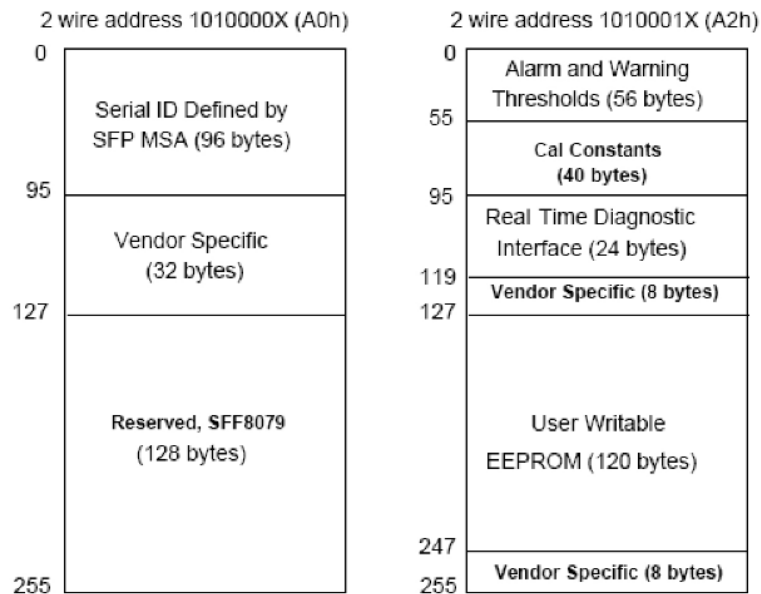

About ProLabs

Our experience comes as standard; for over 15 years ProLabs has delivered optical connectivity solutions that give our customers freedom and choice through our ability to provide seamless interoperability. At the heart of our company is the ability to provide state-of-the-art optical transport and connectivity solutions that are compatible with over 90 optical switching and transport platforms.

Complete Portfolio of Network Solutions

ProLabs is focused on innovations in optical transport and connectivity. The combination of our knowledge of optics and networking equipment enables ProLabs to be your single source for optical transport and connectivity solutions from 100Mb to 400G while providing innovative solutions that increase network efficiency. We provide the optical connectivity expertise that is compatible with and enhances your switching and transport equipment.

Trusted Partner

Customer service is our number one value. ProLabs has invested in people, labs and manufacturing capacity to ensure that you get immediate answers to your questions and compatible product when needed. With Engineering and Manufacturing offices in the U.K. and U.S. augmented by field offices throughout the U.S., U.K. and Asia, ProLabs is able to be our customers best advocate 24 hours a day.

Contact Information

ProLabs US

Email: sales@prolabs.com

Telephone: 952-852-0252

ProLabs UK

Email: salessupport@prolabs.com

Telephone: +44 1285 719 600