















D.C. Motors



Products and specifications subject to change without notice.

Order/Technical Support - Tel: (800) 677-5311 / FAX: (800) 677-3865 / www.crouzet-usa.com

DC Motors Selection guide

Gearbox Speed		Torque max (Nm)		0.5		1.2
		Type of Gearbox		81 012	81 021	81 032.1
Direct Motors						
Power usable (w)	Torque nominal (mN.m)	Speed nominal (rpm)	Voltage supply (V)	Type of motor dimensions (mm)		
3	7.7	3700	12	► p. 4 82 860 0 Ø 32 	► p.18 82 862 1.5 ... 441 rpm 	► p.16 82 861 0.36... 430 rpm 
			24			
8.7	41.5	2000	12	► p. 8 82 810 0 Ø 42 		► p.20 82 812 20... 130 rpm 
9.4	45		24			
12	45	2580	12	► p. 6 82 810 5 Ø 42 		
13		2750	24			
16	75	2000	12	► p. 8 82 800 0 Ø 42 		► p.20 82 802 20... 130 rpm 
			24			
20	70	2670	12	► p. 6 82 800 5 Ø 42 		
22		3070	24			
20	70	2670	12	► p.10 82 800 8 Ø 42 		
22		3070	24			
27	172	1500	12	► p.12 82 830 0 Ø 63 		
			24			
32	100	3100	12	► p.10 82 850 0 Ø 42 		
33		3200	24			
47	170	2630	12	► p.12 82 830 5 Ø 63 		
50		2770	24			
90	270	3200	24	► p.14 82 890 0 Ø 63 		
95		3360	48			

Selection of a geared motor

This choice is based upon the desired usable power at the gearbox output shaft

$$\text{Power (W)} = \frac{2\pi}{60} C n \quad (\text{Nm}) \quad (\text{Rpm})$$

A geared motor must have usable power equal to or greater than the power required to rotate the load desired. It is selected by checking that the point corresponding to the required operating conditions (torque and speed output) is higher than the nominal torque versus speed curve of the geared motor. The required torque output of a geared motor must be within its maximum recommended torque for continuous duty.

Products and specifications subject to change without notice.

Order/Technical Support - Tel: (800) 677-5311 / FAX: (800) 677-3865 / www.crouzet-usa.com

2			5			6
81 033	81 043	81 044	81 035	81 035	81 037	81 032 6
▶ p.22 82 869 	▶ p.26 82 863 	▶ p.28 82 864 			▶ p.32 82 867 	
0.9 ... 108 rpm	99... 662 rpm	2... 66 rpm			1.72... 344 rpm	
	▶ p.24 80 813 	▶ p.30 80 814 		▶ p.34 80 815 	▶ p.36 80 817 	▶ p.42 82 812
	60... 400 rpm	1... 40 rpm		10.5... 616 rpm	1.04... 208 rpm	4 / 8 / 12 rpm
	▶ p.24 80 803 	▶ p.30 80 804 		▶ p.34 80 805 	▶ p.36 80 807 	▶ p.42 82 802
	60... 400 rpm	1... 40 rpm		10.5... 616 rpm	1.04... 208 rpm	4 / 8 / 12 rpm
			▶ p.38 80 835 			▶ p.44 82 832
			7.4... 426 rpm			5... 69 rpm
				▶ p.40 80 855 		
				13.8... 805 rpm		

Products and specifications subject to change without notice.

Order/Technical Support - Tel: (800) 677-5311 / FAX: (800) 677-3865 / www.crouzet-usa.com

D.C. direct drive brushed motors

→ Ø 32 mm 3.9 Watts

A range of small 32 mm diameter D.C. direct-drive brushed motors with 3.9 Watts output power.

- Available in either 12 or 24 V D.C. versions.
- Sintered bronze bearings lubricated for life.
- Connection by 2.8 mm push-on terminals.
- Interference suppression fitted as standard.



Specifications

	3.9 Watts	3.9 Watts with encoder 1 pulse/revolution	3.9 Watts	3.9 Watts with encoder 1 pulse/revolution
Type	82 860 0	82 860 0	82 860 0	82 860 0
Voltage	12 V	12 V	24 V	24 V
Part numbers	82 860 003	82 860 501	82 860 004	82 860 502
No-load characteristics				
Speed of rotation (rpm)	5000	5000	5000	5000
Absorbed power (W)	1.2	1.2	1.92	1.92
Absorbed current (A)	0.1	0.1	0.08	0.08
Nominal characteristics				
Speed (rpm)	3700	3700	3700	3700
Torque (mN.m)	7.7	7.7	7.7	7.7
Usable power (W)	3	3	3	3
Absorbed power (W)	6.2	6.2	6	6
Absorbed current (A)	0.43	0.43	0.26	0.26
Gearbox case temperature rise (°C)	50	50	50	50
Efficiency (%)	48	48	50	50
General characteristics				
Insulation class (conforming to IEC 85)	B (130 °C)	B (130°C)	B (130 °C)	B (130°C)
Protection rating	IP40	IP 40	IP40	IP 40
Max. output (W)	3.9	3.9	3.9	3.9
Start torque (mN.m)	30	30	30	30
Starting current (A)	1.5	1.5	0.76	0.76
Resistance (Ω)	8	8	32	32
Inductance (mH)	10	10	41.6	41.6
Torque constant (Nm/A)	0.0214	0.0214	0.0448	0.0448
Electrical time constant (ms)	1.3	1.3	1.3	1.3
Mechanical time constant (ms)	36	36	36	36
Thermal time constant (min)	8	8	8	8
Inertia (g.cm ²)	19	19	19	19
Weight (g)	96	96	95	95
No of segments	3	3	3	3
Service life (h)	3000	3000	3000	3000
Sintered bronze bearings	✓	✓	✓	✓

Products adaptations, available on request

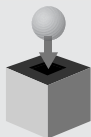

- Special output shafts
- Pinion on output shaft
- Special supply voltages
- Special cable lengths
- Special output bearings
- Optional encoder
- Special mounting plate
- Customized electronics
- Special connectors

Products and specifications subject to change without notice.

Order/Technical Support - Tel: (800) 677-5311 / FAX: (800) 677-3865 / www.crouzet-usa.com

Curves

A - Nominal speed and torque curves
 B - Torque/Current curves

82 860 0

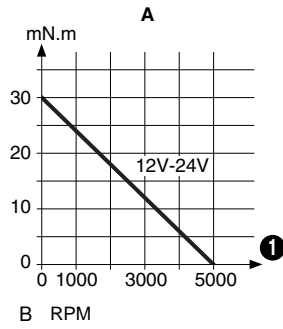

82 860 0

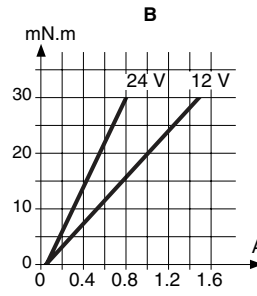

Dimensions

82 860 0

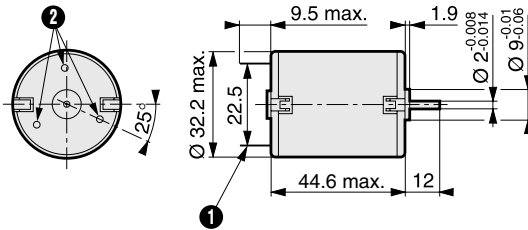

B 2 tags NFC 20 - 120 series 2.8 x 0.5 mm

C 3 holes at 120° on Ø 26 mm : use self tapping screws M2.2 ; screw depth max 6 mm

Products and specifications subject to change without notice.

Order/Technical Support - Tel: (800) 677-5311 / FAX: (800) 677-3865 / www.crouzet-usa.com

D.C. direct drive brushed motors

→ Ø 42 mm 14 to 31 Watts

A range of 42 mm diameter D.C. direct-drive brushed motors with 14 to 31 W output power.

- Available in either 12 or 24 V D.C. versions.
- Sintered bronze bearings lubricated for life
- Replaceable brushes
- Magnetic encoder option



Specifications

	14 Watts	16 Watts	22 Watts	31 Watts
Type	82 810 5	82 810 5	82 800 5	82 800 5
Voltage	12 V	24 V	12 V	24 V
Part numbers	82 810 501	82 810 502	82 800 501	82 800 502
No-load characteristics				
Speed of rotation (rpm)	3840	3860	3920	4010
Absorbed power (W)	12	11.28	9.96	12.24
Absorbed current (A)	1	0.47	0.83	0.51
Nominal characteristics				
Speed (rpm)	2580	2750	2670	3070
Torque (mN.m)	45	45	70	70
Usable power (W)	12	13	20	22
Absorbed power (W)	31	32	37	41
Absorbed current (A)	2.6	1.32	3.05	1.71
Gearbox case temperature rise (°C)	32	33	38	40
Efficiency (%)	39	40.8	54	54
General characteristics				
Insulation class (conforming to IEC 85)	F (155 °C)	F (155 °C)	F (155 °C)	F (155 °C)
Protection (IEC 529) Housing	IP20	IP20	IP20	IP20
Max. output (W)	14	16	22	31
Start torque (mN.m)	138	156	219	298
Starting current (A)	6.2	3.4	9	6.16
Resistance (Ω)	1.94	7.06	1.33	3.9
Inductance (mH)	4.45	16.94	2.67	9.35
Torque constant (Nm/A)	0.0265	0.0532	0.0268	0.0527
Electrical time constant (ms)	2.3	2.4	2	2.4
Mechanical time constant (ms)	26	23	20	15
Thermal time constant (min)	8	8	12	12
Inertia (g.cm ²)	80	72	105	110
Weight (g)	310	310	400	400
No of segments	8	8	8	8
Service life (h)	2000	2000	2000	2000
Sintered bronze bearings	✓	✓	✓	✓
Replaceable brushes (mm)	✓	✓	✓	✓

Products adaptations, available on request

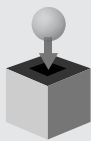

- Special output shafts
- Pinion on output shaft
- Special supply voltages
- Special cable lengths
- Special output bearings
- Optional encoder
- Special mounting plate
- Customized electronics
- Special connectors

Products and specifications subject to change without notice.

Order/Technical Support - Tel: (800) 677-5311 / FAX: (800) 677-3865 / www.crouzet-usa.com

Curves

A - Torque/Speed curves
B - Torque/Current curves

82 810 5

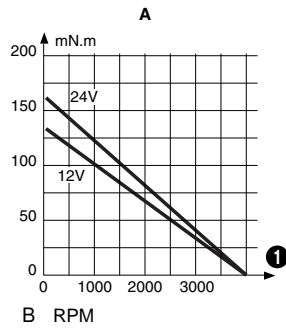

82 810 5

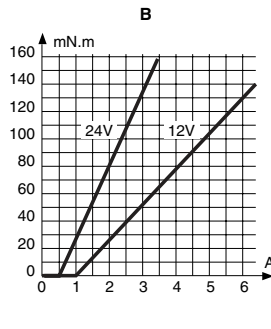

82 800 5

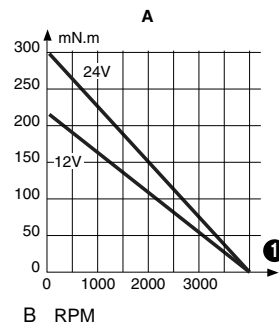

82 800 5

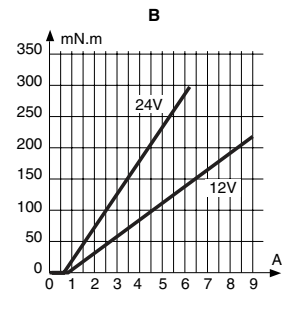

Dimensions

82 810 5

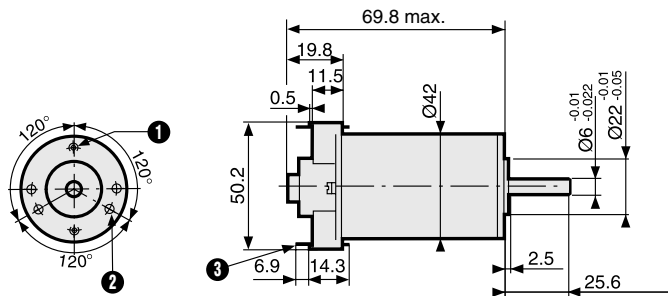

- B 2 M3 at 180° depth 5 mm on Ø 32
- C 2 x Ø 2.75 at 120° depth 5 mm on Ø 32
- D 2 tags IEC 760 series 4.8 x 0.5 mm

82 800 5

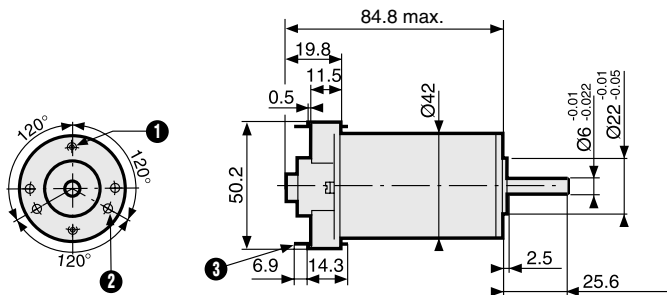

- B 2 M3 at 180° depth 5 mm on Ø 32
- C 2 x Ø 2.75 at 120° depth 5 mm on Ø 32
- D 2 tags IEC 760 series 4.8 x 0.5 mm

Products and specifications subject to change without notice.

Order/Technical Support - Tel: (800) 677-5311 / FAX: (800) 677-3865 / www.crouzet-usa.com

D.C. direct drive brushed motors

→ Ø 42 mm 10 to 17 Watts

A range of 42 mm diameter D.C. direct-drive brushed motors with 10 or 17 Watts output power.

- Available in either 12, 24 or 48V D.C. versions
- Sintered bronze bearings lubricated for life
- Supply connection by 4.75 mm tags
- Replaceable brushes
- Optional magnetic encoder



Specifications

	10 Watts	10 Watts	17 Watts	17 Watts
Type	82 810 0	82 810 0	82 800 0	82 800 0
Voltage	12 V	24 V	12 V	24 V
Part numbers	82 810 017	82 810 018	82 800 036	82 800 037
No-load characteristics				
Speed of rotation (rpm)	2850	2780	2960	2750
Absorbed power (W)	4.8	4.3	4.8	4.3
Absorbed current (A)	0.4	0.18	0.4	0.18
Nominal characteristics				
Speed (rpm)	2000	2000	2000	2000
Torque (mN.m)	45	41.5	75	75
Usable power (W)	9.4	8.7	15.7	15.6
Absorbed power (W)	20.4	15.6	30	26.4
Absorbed current (A)	1.7	0.65	2.5	1.1
Gearbox case temperature rise (°C)	45	46	44	40
Efficiency (%)	46	55.7	52	59
General characteristics				
Insulation class (conforming to IEC 85)	F (155 °C)	F (155 °C)	F (155 °C)	F (155 °C)
Protection (IEC 529) Housing	IP20	IP20	IP20	IP20
Max. output (W)	10.3	9.5	16.3	17
Start torque (mN.m)	127	117	185	210
Starting current (A)	4	1.7	5.8	2.7
Resistance (Ω)	3.1	14.6	2	7.7
Inductance (mH)	2.5	10.7	1.8	6.9
Torque constant (Nm/A)	0.035	0.077	0.0342	0.0724
Electrical time constant (ms)	0.8	0.73	0.89	0.89
Mechanical time constant (ms)	19	17	18	16
Thermal time constant (min)	10	10	12	12
Inertia (g.cm ²)	80	72	105	110
Weight (g)	310	310	400	400
No of segments	8	8	8	8
Service life (h)	3000	3000	3000	3000
Sintered bronze bearings	✓	✓	✓	✓
Replaceable brushes (mm)	✓	✓	✓	✓

Products adaptations, available on request

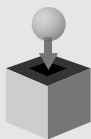

- Special output shafts
- Pinion on output shaft
- Special supply voltages
- Special cable lengths
- Special output bearings
- Optional encoder
- Special mounting plate
- Customized electronics
- Special connectors

Products and specifications subject to change without notice.

Order/Technical Support - Tel: (800) 677-5311 / FAX: (800) 677-3865 / www.crouzet-usa.com

Curves

A - Torque/Speed curves
B - Torque/Current curves

82 810 0

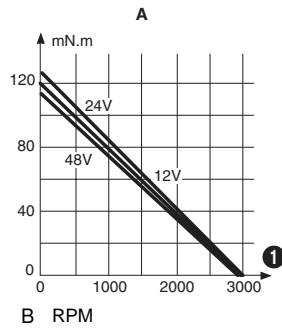

82 810 0

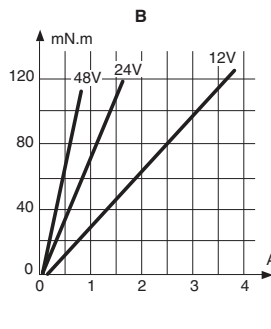

82 800 0

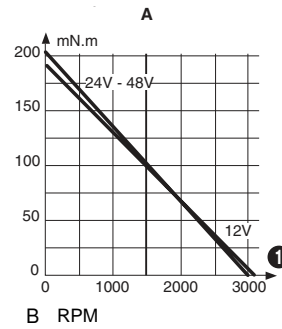

82 800 0

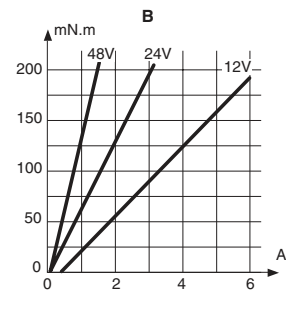

Dimensions

82 810 0

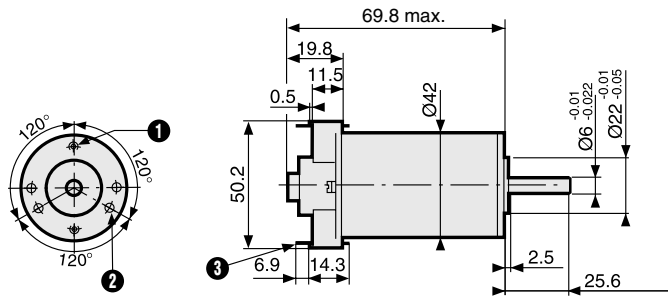

- B 2 M3 at 180° depth 5 mm on Ø 32
- C 2 holes x Ø 2.75^{+0.05} at 120° C depth 5 mm Ø 32
- D 2 tags IEC 760 series 4.8 x 0.5 mm

82 800 0

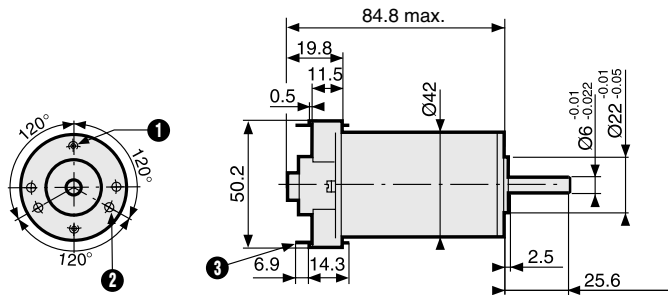

- B 2 M3 at 180° depth 5 mm on Ø 32
- C 2 x Ø 2.75^{+0.05} at 120° depth 5 mm Ø 32
- D 2 tags IEC 760 series 4.8 x 0.5 mm

Products and specifications subject to change without notice.

Order/Technical Support - Tel: (800) 677-5311 / FAX: (800) 677-3865 / www.crouzet-usa.com

D.C. direct drive brushed motors

→ Ø 42 mm 22 to 52 Watts

A range of 42 mm diameter D.C. direct-drive brushed motors with 22 to 52 Watts output power.

- Available in either 12 or 24 V D.C. versions.
- Sintered bronze bearings lubricated for life
- Supply connection by 2 leads



Specifications

	22 Watts	31 Watts	42 Watts	52 Watts
Type	82 800 8	82 800 8	82 850 0	82 850 0
Voltage	12 V	24 V	12 V	24 V
Part numbers	82 800 801	82 800 802	82 850 001	82 850 002
No-load characteristics				
Speed of rotation (rpm)	3920	4010	4150	4050
Absorbed power (W)	9.96	12.24	7.32	7.44
Absorbed current (A)	0.83	0.51	0.61	0.31
Nominal characteristics				
Speed (rpm)	2670	3070	3100	3200
Torque (mN.m)	70	70	100	100
Usable power (W)	20	22	32.5	33.5
Absorbed power (W)	37	41	51	52
Absorbed current (A)	3.05	1.71	4.25	2.15
Gearbox case temperature rise (°C)	38	40	63	54
Efficiency (%)	54	54	63	64
General characteristics				
Insulation class (conforming to IEC 85)	F (155 °C)	F (155 °C)	F (155 °C)	F (155 °C)
Protection (IEC 529) Terminal	IP20	IP20	IP20	IP20
Max. output (W)	22	31	42	52
Start torque (mN.m)	219	298	390	490
Starting current (A)	9	6.16	14.8	9.6
Resistance (Ω)	1.33	3.9	0.81	2.5
Inductance (mH)	2.67	9.35	0.7	2.5
Torque constant (Nm/A)	0.0268	0.0527	0.027	0.052
Electrical time constant (ms)	2	2.4	0.85	1
Mechanical time constant (ms)	20	15	16	13
Thermal time constant (min)	12	12	26	21
Inertia (g.cm ²)	105	110	140	140
Weight (g)	400	400	640	640
No of segments	8	8	8	8
Service life (h)	3000	3000	3000	3000
Sintered bronze bearings	✓	✓	✓	✓
Wires length (mm)	200	200	200	200

Products adaptations, available on request

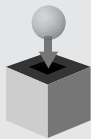

- Special output shafts
- Pinion on output shaft
- Special supply voltages
- Special cable lengths
- Special output bearings
- Optional encoder
- Special mounting plate
- Customized electronics
- Special connectors

Products and specifications subject to change without notice.

Order/Technical Support - Tel: (800) 677-5311 / FAX: (800) 677-3865 / www.crouzet-usa.com

Curves

A - Torque/Speed curves
B - Torque/Current curves

82 800 8

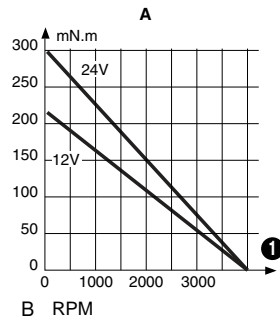

82 800 8

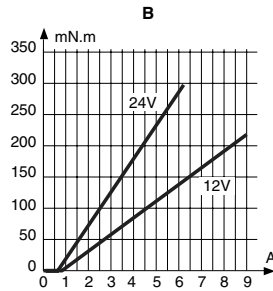

82 850 0

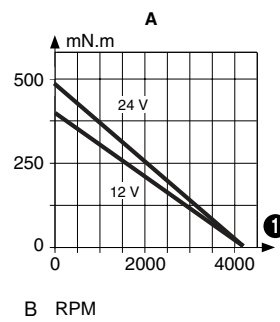

82 850 0

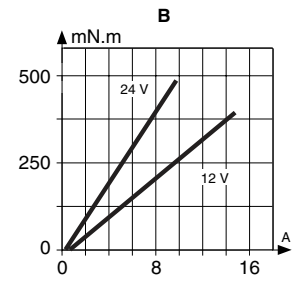

Dimensions

82 800 8

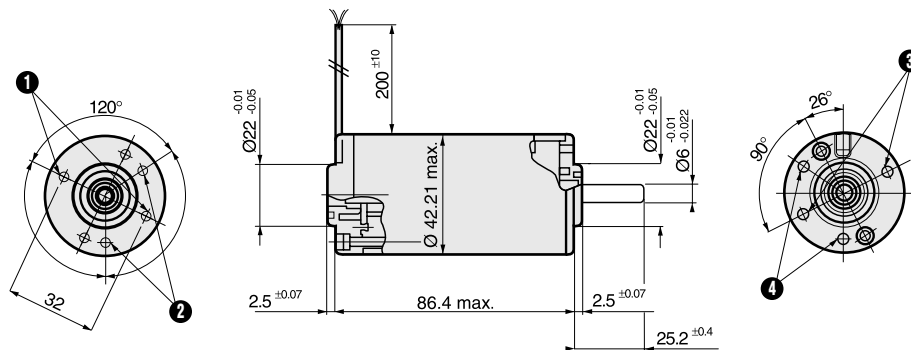

- B 2 holes M3 x 0.5 at 180° depth 5 on $\varnothing 32$
- C 2 holes 2.75 ± 0.05 at 120° depth 5 mm on $\varnothing 32$
- D 2 holes M3 x 0.5 at 180° depth 5.5 on $\varnothing 32$
- E 2 holes M3 x 0.5 at 120° depth 5.5 on $\varnothing 32$

82 850 0

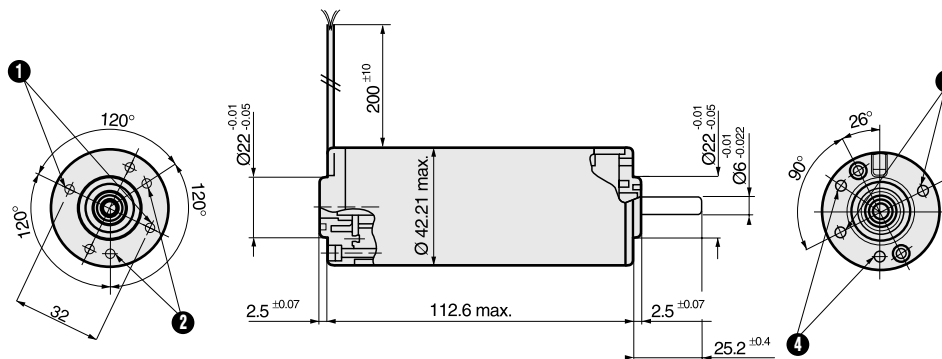

- B 2 holes M3 x 0.5 at 180° depth 5 mm on $\varnothing 32$
- C 2 holes 2.75 ± 0.05 at 120° depth 5 mm on $\varnothing 32$
- D 2 holes M3 x 0.5 at 180° depth 5.5 mm on $\varnothing 32$
- E 2 holes M3 x 0.5 at 120° depth 5.5 mm on $\varnothing 32$

Products and specifications subject to change without notice.

Order/Technical Support - Tel: (800) 677-5311 / FAX: (800) 677-3865 / www.crouzet-usa.com

D.C. direct drive brushed motors

→ Ø 63 mm 33 to 67 Watts

A range of 63mm diameter D.C. direct-drive brushed motors with 33 to 67 W output power.

- Available in either 12, 24 or 48V D.C. versions.
- Ball bearings on output shaft
- Supply connection by 2 leads



Specifications

	33 watts	33 Watts	67 Watts	67 Watts
Type	82 830 0	82 830 0	82 830 5	82 830 5
Voltage	12 V	24 V	12 V	24 V
Part numbers	82 830 009	82 830 010	82 830 501	82 830 502
No-load characteristics				
Speed of rotation (rpm)	2100	2100	3400	3660
Absorbed power (W)	4.8	4.8	12.6	12
Absorbed current (A)	0.4	0.2	1.05	0.5
Nominal characteristics				
Speed (rpm)	1500	1500	2630	2770
Torque (mN.m)	172	172	170	170
Usable power (W)	27	27	47	50
Absorbed power (W)	43	45	72	72
Absorbed current (A)	3.6	1.9	6	3
Gearbox case temperature rise (°C)	50	50	46	50
Efficiency (%)	62	60	65	69.4
General characteristics				
Insulation class (conforming to IEC 85)	F (155 °C)	F (155 °C)	F (155 °C)	F (155 °C)
Protection (IEC 529) Terminal	IP20	IP20	IP20	IP20
Max. output (W)	33	33	67	67
Start torque (mN.m)	600	600	750	700
Starting current (A)	12	6.2	23.1	11.8
Resistance (Ω)	1	3.9	0.52	2.03
Inductance (mH)	1.4	6.4	1.19	4.68
Torque constant (Nm/A)	0.0517	0.1	0.034	0.0619
Electrical time constant (ms)	1.4	1.64	2.3	2.3
Mechanical time constant (ms)	19	19	33	33
Thermal time constant (min)	37	37	20	18
Inertia (g.cm ²)	514	492	520	500
Weight (g)	840	840	840	840
No of segments	12	12	12	12
Service life (h)	5000	5000	4000	4000
Ball bearings	✓	✓	✓	✓
Wires length (mm)	200	200	200	200

Products adaptations, available on request

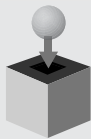

- Special output shafts
- Pinion on output shaft
- Special supply voltages
- Special cable lengths
- Special output bearings
- Optional encoder
- Special mounting plate
- Customized electronics
- Special connectors

Products and specifications subject to change without notice.

Order/Technical Support - Tel: (800) 677-5311 / FAX: (800) 677-3865 / www.crouzet-usa.com

Curves

A - Torque/Speed curves
B - Torque/Current curves

82 830 0

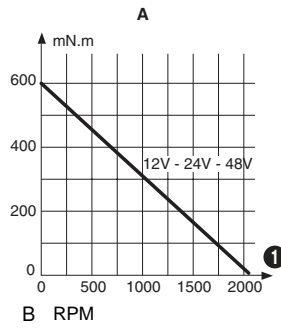

82 830 0

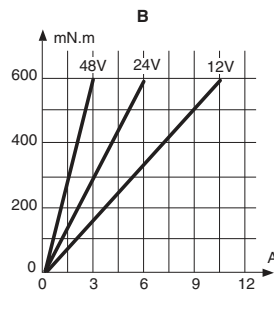

82 830 5

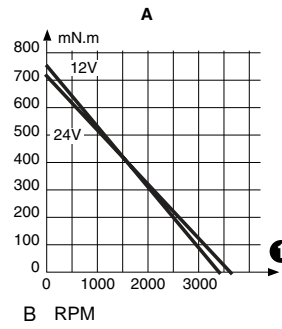

82 830 5

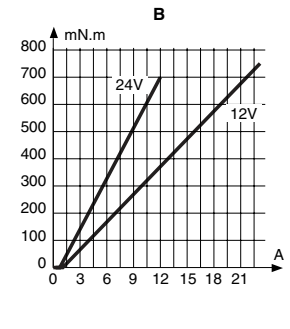

Dimensions

82 830 0

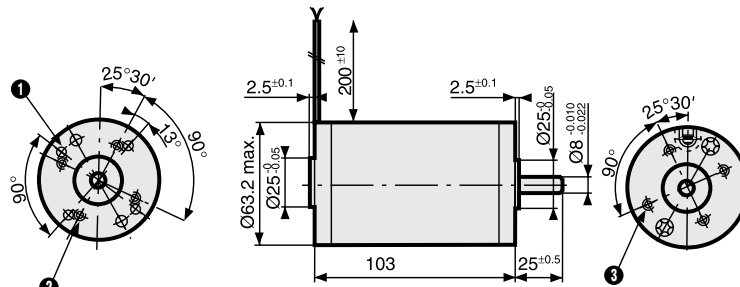

- B 4 holes $\text{Ø} 3.65 \pm 0.05$ at 90° on $\text{Ø} 48$
- C 4 holes M5 on $\text{Ø} 40$ depth 7 mm
- D 4 holes M5 on $\text{Ø} 40$ depth 7 mm

Products and specifications subject to change without notice.

Order/Technical Support - Tel: (800) 677-5311 / FAX: (800) 677-3865 / www.crouzet-usa.com

D.C. direct drive brushed motors

→ Ø 63 mm 194 to 255 Watts

A range of D.C. direct-drive brushed motors with a case diameter of 63 mm and between 194 and 255 Watts output power.

- Available in either 24 or 48V D.C. versions
- Ball bearings on output shaft
- Supply connection by 2 leads



Specifications

	194 Watts	255 Watts
Type	82 890 0	82 890 0
Voltage	24 V	48 V
Part numbers	82 890 001	82 890 002
No-load characteristics		
Speed of rotation (rpm)	3700	3750
Absorbed power (W)	10.8	9.6
Absorbed current (A)	0.45	0.2
Nominal characteristics		
Speed (rpm)	3200	3360
Torque (mN.m)	270	270
Usable power (W)	90	95
Absorbed power (W)	120	118
Absorbed current (A)	5.00	2.45
Gearbox case temperature rise (°C)	50	50
Efficiency (%)	75	80
General characteristics		
Insulation class (conforming to IEC 85)	F (155 °C)	F (155 °C)
Protection (IEC 529) Terminal	IP20	IP20
Max. output (W)	194	255
Start torque (mN.m)	2000	2600
Starting current (A)	34.1	21.7
Resistance (Ω)	0.7	2.2
Inductance (mH)	1.05	4.62
Torque constant (Nm/A)	0.059	0.12
Electrical time constant (ms)	1.5	2.1
Mechanical time constant (ms)	16	12
Thermal time constant (min)	41	36
Inertia (g.cm ²)	795	795
Weight (g)	1580	1580
No of segments	12	12
Service life (h)	5000	5000
Ball bearings	✓	✓
Wires length (mm)	200	200

Products adaptations, available on request

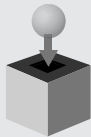

- Special output shafts
- Pinion on output shaft
- Special supply voltages
- Special cable lengths
- Special output bearings
- Optional encoder
- Special mounting plate
- Customized electronics
- Special connectors

Products and specifications subject to change without notice.

Order/Technical Support - Tel: (800) 677-5311 / FAX: (800) 677-3865 / www.crouzet-usa.com

Curves

A - Torque/Speed curves
B - Torque/Current curves

82 890 0

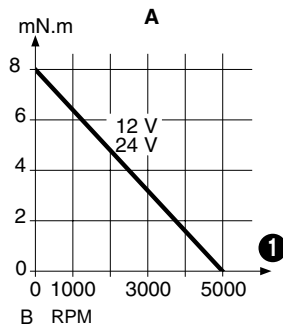

82 890 0

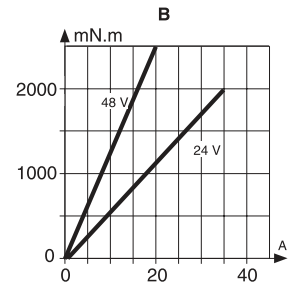

Dimensions

82 890 0

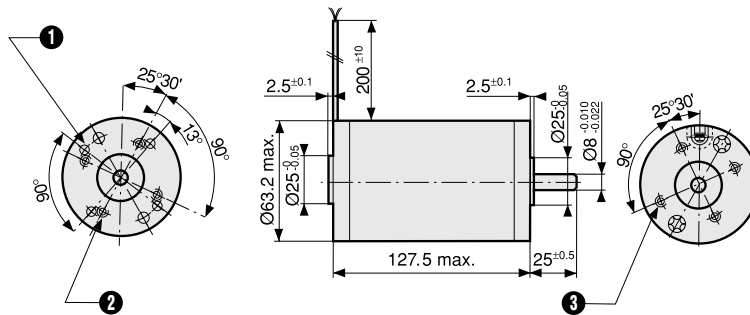

- B 4 holes $\varnothing 3.65 \pm 0.05$ at 90° on $\varnothing 48$
- C 4 holes M5 on $\varnothing 40$ depth 7 mm
- D 4 holes M5 on $\varnothing 40$ depth 7 mm

Products and specifications subject to change without notice.

Order/Technical Support - Tel: (800) 677-5311 / FAX: (800) 677-3865 / www.crouzet-usa.com

D.C. geared motors with brushes

→ 0.5 Nm 3.9 Watts

A range of D.C. geared motors with ovoid gearbox.

- Mechanical rating of gearbox with output shaft stalled : 0.5 Nm.
- 3.9 Watt motor versions.
- Available in either 12 or 24 V D.C.
- Gearbox ratios options for 0.36 to 430 rpm.



Specifications

		3.9 Watts	3.9 Watts
Type		82 861 0	82 861 0
Voltage		12 V	24 V
Standard speed (rpm)		4300	4300
Output speed (rpm)	Ratios (i)		
430	10	82 861 006	82 861 015
215	20	82 861 007	82 861 016
179	24	82 861 0X00024B ●	82 861 0Y00024B ●
143	30	82 861 008	82 861 017
108	40	82 861 009	82 861 018
90	48	82 861 0X00048B ●	82 861 0Y00048B ●
54	80	82 861 010	82 861 019
49	90	82 861 0X00090B ●	82 861 0Y00090B ●
29	150	82 861 0X00150B ●	82 861 0Y00150B ●
22	200	82 861 011	82 861 020
11	375	82 861 012	82 861 021
8.6	500	82 861 013	82 861 022
5.8	750	82 861 0X00750B ●	82 861 0Y00750B ●
3.6	1200	82 861 014	82 861 023
1.8	2400	82 861 0X02400B ●	82 861 0Y02400B ●
0.80	5400	82 861 0X05400B ●	82 861 0Y05400B ●
0.36	12000	82 861 0X12000B ●	82 861 0Y12000B ●
General characteristics			
Motor		82 860 0	82 860 0
Gearbox		81 021 0	81 021 0
Maximum permitted torque from gearmotor under continuous conditions (for 1 millions turns) Nm		0.5	0.5
Axial load (static) daN		1	1
Radial load (static) daN		8	8
Max. output (W)		3.9	3.9
Nominal output (W)		3	3
Gearbox case temperature rise (°C)		50	50
Weight (g)		160	160

Products adaptations, available on request

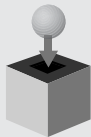

- Special supply voltages
- Special lead lengths
- Optional encoder
- Special connectors
- Special output shafts
- Special gearbox ratios
- Special gear material
- Special output bearings
- Special mounting plate

Products and specifications subject to change without notice.

Order/Technical Support - Tel: (800) 677-5311 / FAX: (800) 677-3865 / www.crouzet-usa.com

Curves

The shaded zone represents the operating range of the geared motor.
 The horizontal line marks the maximum torque available in continuous duty cycle for a given life.
 For higher torque ratings, service life will be reduced.

Nominal speed and torque curves

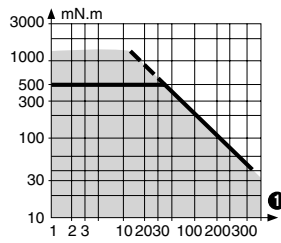

B RPM

Dimensions

82 861 0

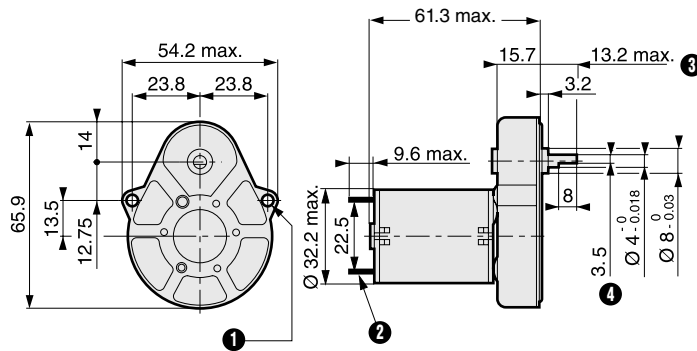

- B 2 fixing holes $\varnothing 3.2$
- C 2 tags NFC 20-120 series 2.8 x 0.5 mm
- D (shaft pushed-in \leftarrow)
- E 3.5 mm across flats

Options

Shaft 70 999 421
 SP1295.10

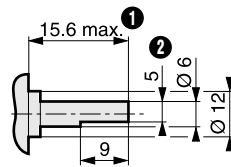

- B (shaft pushed-in \leftarrow)
- C 5 across flat

Shaft 79 200 779

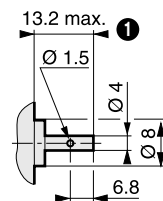

- B (shaft pushed-in \leftarrow)

Shaft 79 200 967

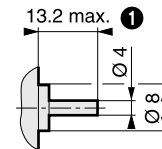

- B (shaft pushed-in \leftarrow)

Products and specifications subject to change without notice.

Order/Technical Support - Tel: (800) 677-5311 / FAX: (800) 677-3865 / www.crouzet-usa.com

D.C. geared motors with brushes

→ 0.5 Nm 3.9 Watts

A range of D.C. geared motors with sintered metal gears.

- Mechanical rating of gearbox with output shaft stalled : 0.5 Nm.
- 3.9 Watt motor power
- Available in either 12 or 24 V D.C. versions.
- Gearbox ratios options for 1.5 to 441 rpm.
- Options with magnetic encoder.



Specifications

		3.9 Watts	3.9 Watts
Type		82 862 0/2	82 862 0/2
Voltage		12 V	24 V
Output speed (rpm)	Ratios (i)		
441	9.76	82 862 001	82 862 004
141	30.6	82 862 002	82 862 005
45	95.4	82 862 003	82 862 006
14	298	82 862 201	82 862 204
5	931	82 862 202	82 862 205
1.5	2910	82 862 203	82 862 206
General characteristics			
Motor		82 860 0	82 860 0
Gearbox		81 012 0 / 81 012 2	81 012 0 / 81 012 2
Maximum permitted torque from gearmotor under continuous conditions (for 1 millions turns) N.m		0.5	0.5
Axial load (static) daN		1	1
Radial load (static) daN		8	8
Max. output (W)		3.9	3.9
Nominal output (W)		3	3
Gearbox case temperature rise (°C)		50	50
Weight (g)		160 / 170	160 / 170

Products adaptations, available on request



- Special supply voltages
- Special lead lengths
- Optional encoder
- Special connectors
- Special output shafts
- Special gearbox ratios
- Special gear material
- Special output bearings
- Special mounting plate

Products and specifications subject to change without notice.

Order/Technical Support - Tel: (800) 677-5311 / FAX: (800) 677-3865 / www.crouzet-usa.com

Curves

The shaded zone represents the operating range of the geared motor.
 The horizontal line marks the maximum torque available in continuous duty cycle for a given life.
 For higher torque ratings, service life will be reduced.

Nominal speed and torque curves

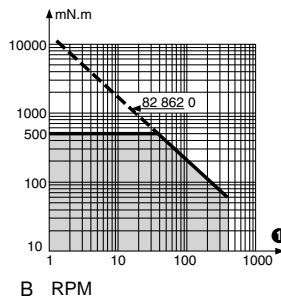

Dimensions

82 862 0

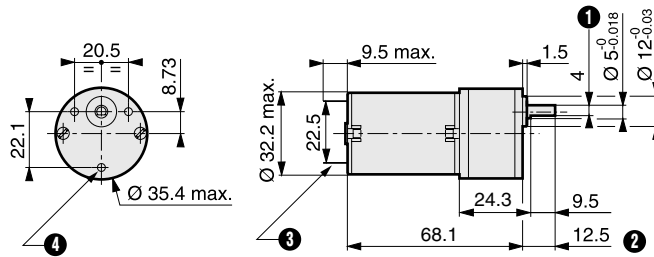

- B 4 mm across flats
- C (shaft pushed-in ←)
- D 2 tags NFC 20-120 series 2.8 x 0.5 mm
- E 3 holes M3 depth 4.5 mm

82 862 2

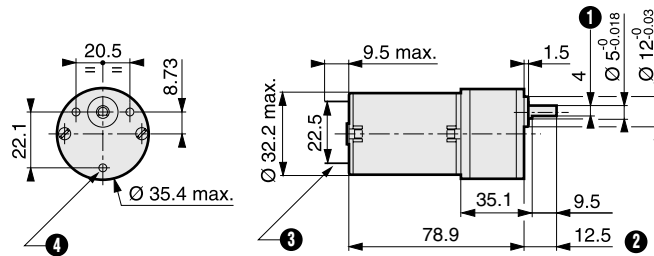

- B 4 mm across flats
- C (shaft pushed-in ←)
- D 2 tags NFC 20-120 series 2.8 x 0.5 mm
- E 3 holes M3 depth 4.5 mm

Products and specifications subject to change without notice.

Order/Technical Support - Tel: (800) 677-5311 / FAX: (800) 677-3865 / www.crouzet-usa.com

D.C. geared motors with brushes

→ 1.2 Nm 10 and 17 Watts

A range of D.C. geared motors with solid metal gears

- Mechanical rating of gearbox with output shaft stalled : 1.2 Nm
- 10 and 17 Watt motor power
- Available in either 12, 24 or 48 V D.C.
- Gearbox ratios options for 20 to 100 rpm



Specifications

		17 Watts	17 Watts	10 Watts	10 watts
Type		82 802 0	82 802 0	82 812 0	82 812 0
Voltage		12 V	24 V	12 V	24 V
Output speed (rpm)	Ratios (i)				
100	26	82 802 0X00026Z ●	82 802 0Y00026Z ●	82 812 0X00026Z ●	82 812 0Y00026Z ●
80	32.5	82 802 0X032.5Z ●	82 802 0Y032.5Z ●	82 812 0X032.5Z ●	82 812 0Y032.5Z ●
60	130/3	82 802 0X43.33Z ●	82 802 0Y43.33Z ●	82 812 0X43.33Z ●	82 812 0Y43.33Z ●
38	67.6	82 802 0X067.6Z ●	82 802 0Y067.6Z ●	82 812 0X067.6Z ●	82 812 0Y067.6Z ●
30	598/7	82 802 0X85.43Z ●	82 802 0Y85.43Z ●	82 812 0X85.43Z ●	82 812 0Y85.43Z ●
20	130	82 802 0X00130Z ●	82 802 0Y00130Z ●	82 812 0X00130Z ●	82 812 0Y00130Z ●
General characteristics					
Motor		82 800 0	82 800 0	82 810 0	82 810 0
Gearbox		81 032 1	81 032 1	81 032 1	81 032 1
Maximum permitted torque from gearmotor under continuous conditions for 10 millions turns Nm		1.2	1.2	1.2	1.2
Axial load (dynamic) daN		3.5	3.5	3.5	3.5
Radial load (dynamic) daN		5	5	5	5
Max. output (W)		16.3	17	10.3	9.5
Nominal output (W)		15.7	15.6	9.4	8.7
Gearbox case temperature rise (°C)		44	40	45	46
Weight (g)		670	670	670	670

Products adaptations, available on request

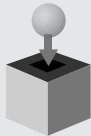

- Special supply voltages
- Special lead lengths
- Optional encoder
- Special connectors
- Special output shafts
- Special gearbox ratios
- Special gear material
- Special output bearings
- Special mounting plate

Products and specifications subject to change without notice.

Order/Technical Support - Tel: (800) 677-5311 / FAX: (800) 677-3865 / www.crouzet-usa.com

Curves

The shaded zone represents the operating range of the geared motor.
The horizontal line marks the maximum torque available in continuous duty cycle for a given life.
For higher torque ratings, service life will be reduced.

Nominal speed and torque curves
82 802 0

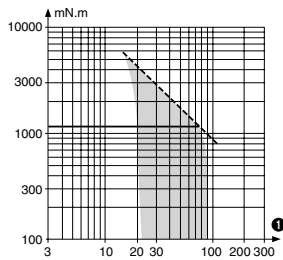

B RPM

Nominal speed and torque curves
82 812 0

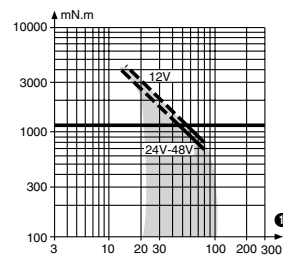

B RPM

Dimensions

82 802 0 Standard

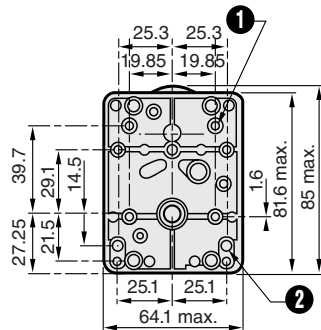

- B 4 holes M4 depth 7.5 mm
- C 3 holes M5 at 120° depth 7.5 mm
- D 2 tags IEC 760 series 4.8 x 0.5 mm
- E 7 mm across flats
- F (shaft pushed-in ←)

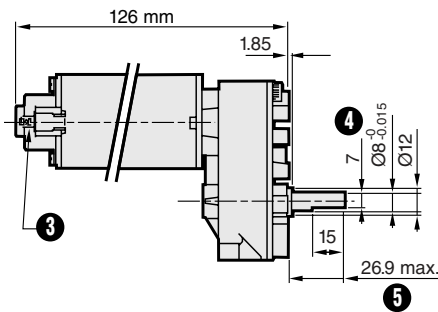

82 812 0 Standard

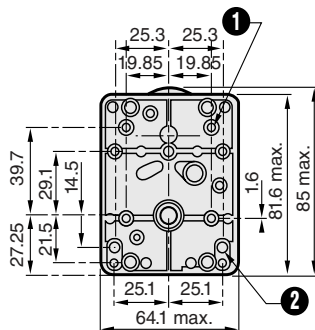

- B 8 holes M4 depth 7.5 mm
- C 3 holes M5 at 120° depth 7.5 mm
- D 2 tags IEC 760 series 4.8 x 0.5 mm
- E 7 mm across flats
- F (shaft pushed-in ←)

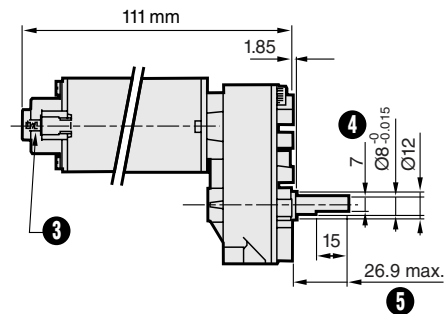

Products and specifications subject to change without notice.

Order/Technical Support - Tel: (800) 677-5311 / FAX: (800) 677-3865 / www.crouzet-usa.com

D.C. geared motors with brushes

→ 2 Nm 3.9 Watts

A range of D.C. geared motors with ovoid gearbox.

- Mechanical rating of gearbox with output shaft stalled : 2 Nm.
- 3.9 Watt motor versions.
- Available in either 12 or 24 V D.C.
- Gearbox ratios options for 0.36 to 430 rpm.
- Alternative shaft options.



Specifications

		3.9 Watts	3.9 Watts
Type		82 869 0	82 869 0
Voltage		12 V	24 V
Output speed (rpm)	Ratios (i)		
108	40	82 869 001	82 869 011
54	80	82 869 006	82 869 012
27	160	82 869 007	82 869 013
13	320	82 869 008	82 869 014
7.2	600	82 869 009	82 869 015
5.4	800	82 869 0X00800X ●	82 869 0Y00800X ●
2.9	1500	82 869 010	82 869 016
0.90	4800	82 869 0X04800X ●	82 869 0Y04800X ●
General characteristics			
Motor		82 860 0	82 860 0
Gearbox		81 033 0	81 033 0
Maximum permitted torque from gearmotor under continuous conditions for 1 millions turns Nm		2	2
Axial load (static) daN		1	1
Radial load (static) daN		10	10
Max. output (W)		3.9	3.9
Nominal output (W)		3	3
Gearbox case temperature rise (°C)		50	50
Weight (g)		240	240

Products adaptations, available on request



- Special supply voltages
- Special lead lengths
- Optional encoder
- Special connectors
- Special output shafts
- Special gearbox ratios
- Special gear material
- Special output bearings
- Special mounting plate

Products and specifications subject to change without notice.

Order/Technical Support - Tel: (800) 677-5311 / FAX: (800) 677-3865 / www.crouzet-usa.com

Curves

The shaded zone represents the operating range of the geared motor.
The horizontal line marks the maximum torque available in continuous duty cycle for a given life.
For higher torque ratings, service life will be reduced.

Nominal speed and torque curves

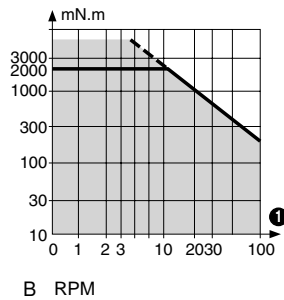

Dimensions

82 869 0

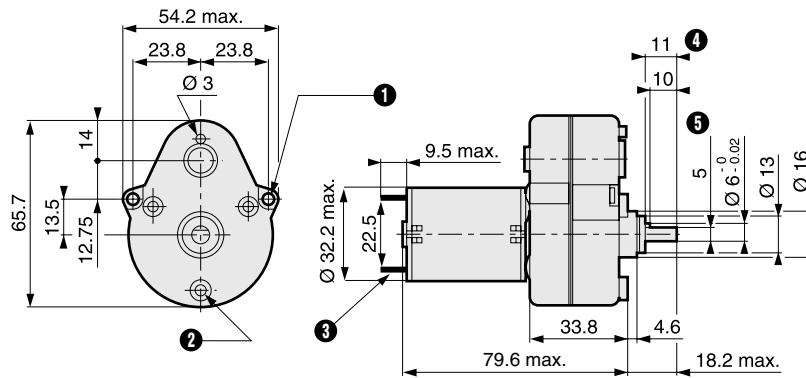

- B 2 fixing holes Ø 3.2
- C 3 bosses Ø 7.2 at 120° on R=19.5 with 3 M3 holes
- D 2 tags NFC 20-120 series 2.8 x 0.5 mm
- E (shaft pushed-in ←)
- F 5 mm across flats

Options

Shaft 79 202 573

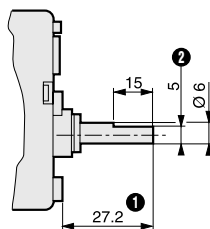

- B (shaft pushed-in ←)
- C 5 across flat

Products and specifications subject to change without notice.

Order/Technical Support - Tel: (800) 677-5311 / FAX: (800) 677-3865 / www.crouzet-usa.com

D.C. geared motors with brushes

→ 2 Nm 10 and 17 Watts

A range of D.C. geared motors with solid metal gears

- Mechanical rating of gearbox with output shaft stalled : 1.2 Nm
- 10 and 17 Watt motor power
- Available in either 12, 24 or 48 V D.C.
- Gearbox ratios options for 60 to 400 rpm



Specifications

		17 Watts	17 Watts	10 Watts	10 Watts
Type		80 803 0	80 803 0	80 813 0	80 813 0
Voltage		12 V	24 V	12 V	24 V
Output speed (rpm)	Ratios (i)				
400	13/2	80 803 0X006.5Z ●	80 803 0Y006.5Z ●	80 813 0X006.5Z ●	80 813 0Y006.5Z
301	855/99	80 803 0X8.636Z ●	80 803 0Y8.636Z ●	80 813 0X8.636Z ●	80 813 0Y8.636Z
161	728/45	80 803 005	80 803 008	80 813 0X16.18Z ●	80 813 0Y16.18Z
120	65/3	80 803 0X21.67Z ●	80 803 0Y21.67Z ●	80 813 0X21.67Z ●	80 813 0Y21.67Z
103	455/18	80 803 0X25.28Z ●	80 803 0Y25.28Z ●	80 813 0X25.28Z ●	80 813 0Y25.28Z
80	32.5	80 803 006	80 803 009	80 813 0X32.5Z ●	80 813 0Y32.5Z
60	130/3	80 803 007	80 803 010	80 813 0X43.33Z ●	80 813 0Y43.33Z
General characteristics					
Motor		82 800 0	82 800 0	82 810 0	82 810 0
Gearbox		81 043 0	81 043 0	81 043 0	81 043 0
Maximum permitted torque from gearmotor under continuous conditions for 1 millions turns Nm		2	2	2	2
Axial load (dynamic) daN		2	2	2	2
Radial load (dynamic) daN		2	2	2	2
Max. output (W)		16.3	17	10.3	9.5
Nominal output (W)		15.7	15.6	9.4	8.7
Gearbox case temperature rise (°C)		44	40	45	46
Weight (g)		600	600	500	500

Products adaptations, available on request

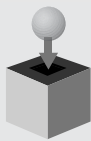

- Special supply voltages
- Special lead lengths
- Optional encoder
- Special connectors
- Special output shafts
- Special gearbox ratios
- Special gear material
- Special output bearings
- Special mounting plate

Products and specifications subject to change without notice.

Order/Technical Support - Tel: (800) 677-5311 / FAX: (800) 677-3865 / www.crouzet-usa.com

Curves

The shaded zone represents the operating range of the geared motor.
The horizontal line marks the maximum torque available in continuous duty cycle for a given life.
For higher torque ratings, service life will be reduced.

Nominal speed and torque curves
80 803 0

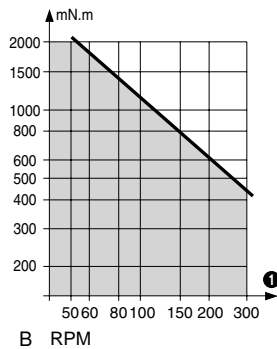

Nominal speed and torque curves
80 813 0

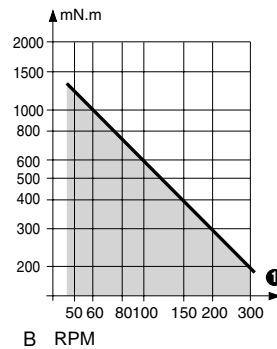

Dimensions

80 803 0 Standard

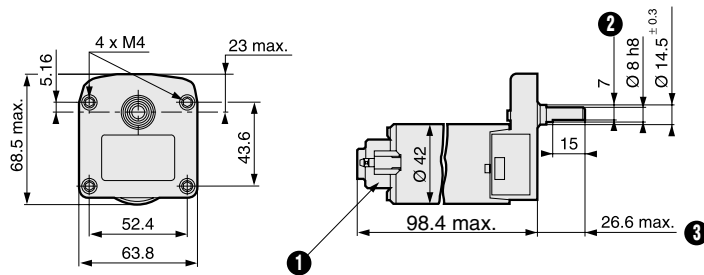

- B 2 tags IEC 760 series 4.8 x 0.5 mm
- C 7 mm across flats
- D (shaft pushed-in ←)

80 813 0 Standard

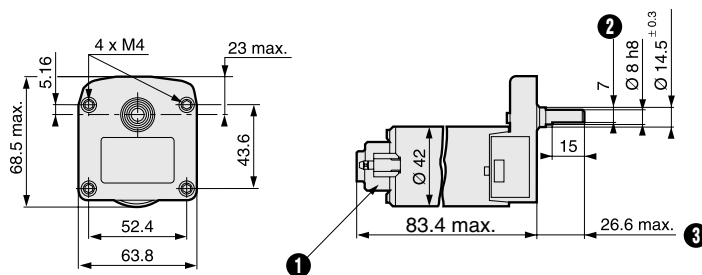

- B 2 tags IEC 760 series 4.8 x 0.5 mm
- C 7 mm across flats
- D (shaft pushed-in ←)

Options

Shaft 79 261 300

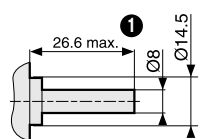

- B (shaft pushed-in ←)

Shaft 79 261 309

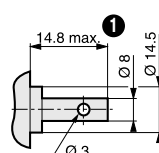

- B (shaft pushed-in ←)

Products and specifications subject to change without notice.

Order/Technical Support - Tel: (800) 677-5311 / FAX: (800) 677-3865 / www.crouzet-usa.com

D.C. geared motors with brushes

→ 2 Nm 3.9 Watts

A range of D.C. geared motors with metal gearbox.

- Mechanical rating of gearbox with output shaft stalled : 2 Nm.
- 3.9 Watt motor power.
- Available in either 12 or 24 V D.C.
- Gearbox ratios options for 99 to 662 rpm.



Specifications

		3.9 Watts	3.9 Watts
Type		82 863 0	82 863 0
Voltage		12 V	24 V
Output speed (rpm)	Ratios (i)		
662	13/2	82 863 0X006.5Z ●	82 863 0Y006.5Z ●
498	855/99	82 863 0X8.636Z ●	82 863 0Y8.636Z ●
266	728/45	82 863 0X16.18Z ●	82 863 0Y16.18Z ●
198	65/3	82 863 0X21.67Z ●	82 863 0Y21.67Z ●
170	455/18	82 863 0X25.28Z ●	82 863 0Y25.28Z ●
132	32.5	82 863 0X032.5Z ●	82 863 0Y032.5Z ●
99	130/3	82 863 0X43.33Z ●	82 863 0Y43.33Z ●
General characteristics			
Motor		82 860 0	82 860 0
Gearbox		81 043 0	81 043 0
Maximum permitted torque from gearmotor under continuous conditions (for 1 millions turns) N.m		2	2
Axial load (dynamic) daN		2	2
Radial load (dynamic) daN		2	2
Max. output (W)		3.9	3.9
Nominal output (W)		3	3
Gearbox case temperature rise (°C)		50	50
Weight (g)		285	285

Products adaptations, available on request

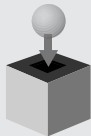

- Special supply voltages
- Special lead lengths
- Optional encoder
- Special connectors
- Special output shafts
- Special gearbox ratios
- Special gear material
- Special output bearings
- Special mounting plate

Products and specifications subject to change without notice.

Order/Technical Support - Tel: (800) 677-5311 / FAX: (800) 677-3865 / www.crouzet-usa.com

Curves

The shaded zone represents the operating range of the geared motor.
The horizontal line marks the maximum torque available in continuous duty cycle for a given life.
For higher torque ratings, service life will be reduced.

Nominal speed and torque curves

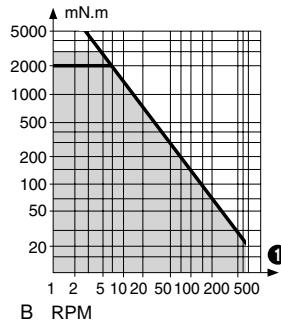

Dimensions

82 863 0

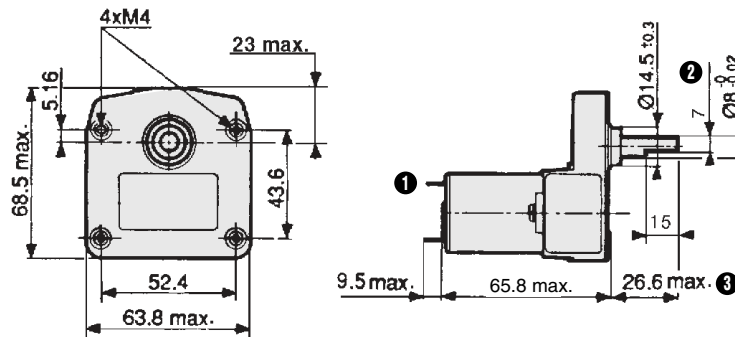

- B 2 tags NFC 20-120 series 2.8 x 0.5 mm
- C 7 mm across flats
- D (shaft pushed-in ←)

Options

Shaft 79 261 300

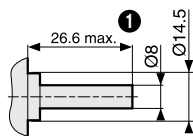

B (shaft pushed-in ←)

Shaft 79 261 309

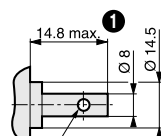

B (shaft pushed-in ←)

Products and specifications subject to change without notice.

Order/Technical Support - Tel: (800) 677-5311 / FAX: (800) 677-3865 / www.crouzet-usa.com

D.C. geared motors with brushes

→ 2 Nm 3.9 Watts

A range of D.C. geared motors with metal gearbox.

- Mechanical rating of gearbox with output shaft stalled : 2 Nm.
- 3.9 Watt motor versions.
- Available in either 12 or 24 V D.C.
- Gearbox ratios options for 2 to 66 rpm.



Specifications

		3.9 Watts		3.9 Watts
Type		82 864 0		82 864 0
Voltage		12 V		24 V
Output speed (rpm)	Ratios (i)			
66	65	82 864 0X00065Z ●		82 864 0Y00065Z ●
40	325/3	82 864 0X108.3Z ●		82 864 0Y108.3Z ●
26	162.5	82 864 0X162.5Z ●		82 864 0Y162.5Z ●
13	325	82 864 0X00325Z ●		82 864 0Y00325Z ●
7	650	82 864 0X00650Z ●		82 864 0Y00650Z ●
2	2600	82 864 0X02600Z ●		82 864 0Y02600Z ●
General characteristics				
Motor		82 860 0		82 860 0
Gearbox		81 044 0		81 044 0
Maximum permitted torque from gearmotor under continuous conditions (for 1 millions turns) N.m		2		2
Axial load (dynamic) daN		2		2
Radial load (dynamic) daN		2		2
Max. output (W)		3.9		3.9
Nominal output (W)		3		3
Gearbox case temperature rise (°C)		50		50
Weight (g)		355		355

Products adaptations

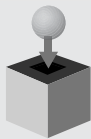

- Special supply voltages
- Special lead lengths
- Optional encoder
- Special connectors
- Special output shafts
- Special gearbox ratios
- Special gear material
- Special output bearings
- Special mounting plate

Products and specifications subject to change without notice.

Order/Technical Support - Tel: (800) 677-5311 / FAX: (800) 677-3865 / www.crouzet-usa.com

Curves

The shaded zone represents the operating range of the geared motor.
The horizontal line marks the maximum torque available in continuous duty cycle for a given life.
For higher torque ratings, service life will be reduced.

Nominal speed and torque curves

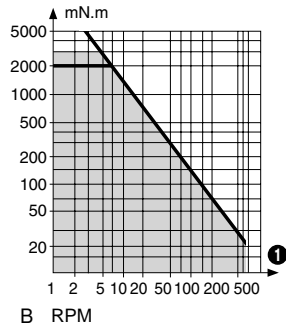

Dimensions

82 864 0

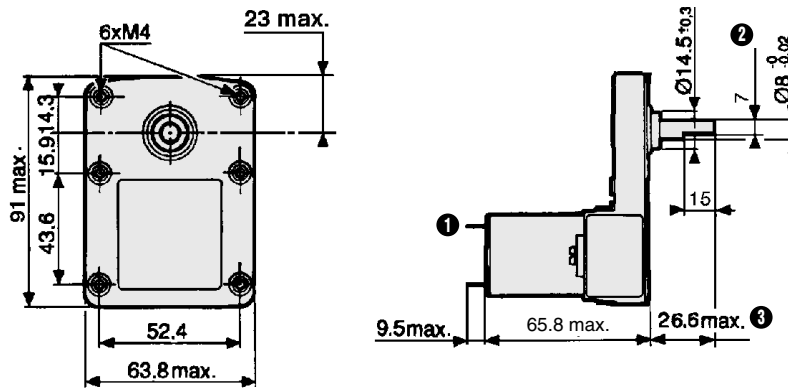

- B 2 tags NFC 20-120 series 2.8 x 0.5 mm
- C 7 mm across flats
- D (shaft pushed-in ←)

Options

Shaft 79 261 300

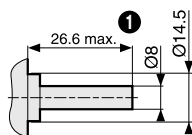

- B (shaft pushed-in ←)

Shaft 79 261 309

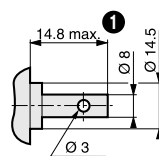

- B (shaft pushed-in ←)

Shaft 79 261 314

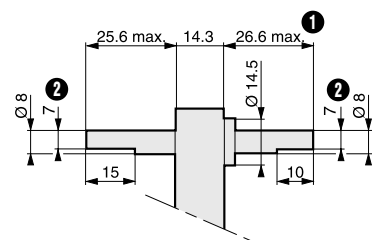

- B (shaft pushed-in ←)
- C 7 across flat

Products and specifications subject to change without notice.

Order/Technical Support - Tel: (800) 677-5311 / FAX: (800) 677-3865 / www.crouzet-usa.com

D.C. geared motors with brushes

→ 2 Nm 10 and 17 Watts

A range of D.C. geared motors with solid metal gears.

- Mechanical rating of gearbox with output shaft stalled : 2 Nm.
- 10 and 17 Watt motor power.
- Available in either 12, 24 or 48 V D.C.
- Gearbox ratios options for 1 to 40 rpm.



Specifications

		17 Watts	17 Watts	10 Watts	10 Watts
Type		80 804 0	80 804 0	80 814 0	80 814 0
Voltage		12 V	24 V	12 V	24 V
Output speed (rpm)	Ratios (i)				
40	65	80 804 0X00065Z ●	80 804 0Y00065Z ●	80 814 0X00065Z ●	80 814 0Y00065Z ●
24	325/3	80 804 006	80 804 009	80 814 0X108.3Z ●	80 814 0Y108.3Z ●
16	162.5	80 804 0X162.5Z ●	80 804 0Y162.5Z ●	80 814 0X162.5Z ●	80 814 0Y162.5Z ●
8	325	80 804 007	80 804 010	80 814 0X00325Z ●	80 814 0Y00325Z ●
4	650	80 804 008	80 804 011	80 814 0X00650Z ●	80 814 0Y00650Z ●
1	2600	80 804 0X02600Z ●	80 804 0Y02600Z ●	80 814 0X02600Z ●	80 814 0Y02600Z ●
General characteristics					
Motor		82 800 0	82 800 0	82 810 0	82 810 0
Gearbox		81 044 0	81 044 0	81 044 0	81 044 0
Maximum permitted torque from gearmotor under continuous conditions for 1 millions turns Nm		2	2	2	2
Axial load (dynamic) daN		2	2	2	2
Radial load (dynamic) daN		2	2	2	2
Max. output (W)		16.3	17	10.3	9.5
Nominal output (W)		15.7	15.6	9.3	8.7
Gearbox case temperature rise (°C)		44	40	45	46
Weight (g)		670	670	570	570

Products adaptations, available on request

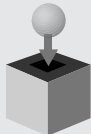

- Special supply voltages
- Special lead lengths
- Optional encoder
- Special connectors
- Special output shafts
- Special gearbox ratios
- Special gear material
- Special output bearings
- Special mounting plate

Products and specifications subject to change without notice.

Order/Technical Support - Tel: (800) 677-5311 / FAX: (800) 677-3865 / www.crouzet-usa.com

Curves

The shaded zone represents the operating range of the geared motor.
The horizontal line marks the maximum torque available in continuous duty cycle for a given life.
For higher torque ratings, service life will be reduced.

Nominal speed and torque curves
80 804 0

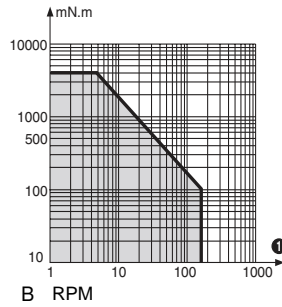

Nominal speed and torque curves
80 814 0

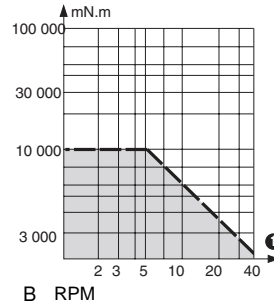

Dimensions

80 804 0 Standard

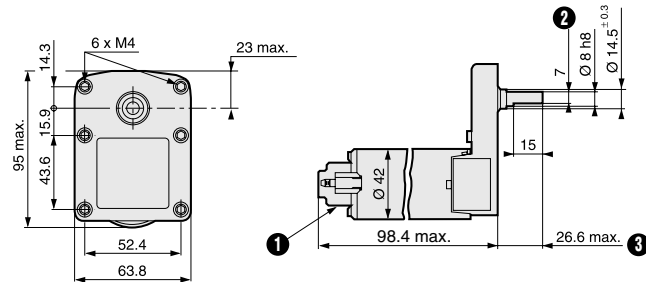

- B 2 tags IEC 760 series 4.8 x 0.5 mm
- C 7 mm across flats
- D (shaft pushed-in ←)

80 814 0 Standard

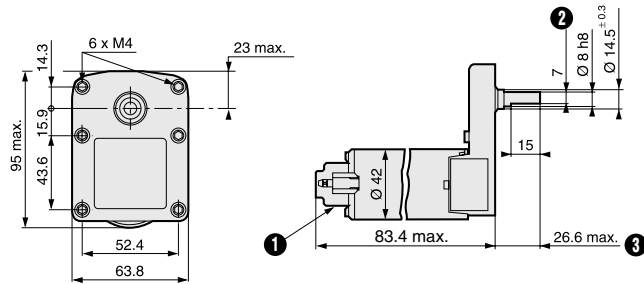

- B 2 tags IEC 760 series 4.8 x 0.5 mm
- C 7 mm across flats
- D (shaft pushed-in)

Options

Shaft 79 261 300

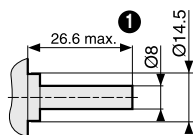

- B (shaft pushed-in ←)

Shaft 79 261 309

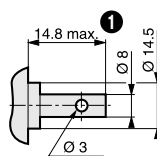

- B (shaft pushed-in ←)

Shaft 79 261 314

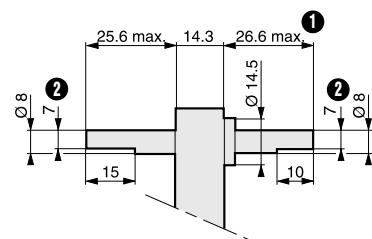

- B (shaft pushed-in ←)
- C 7 across flat

Products and specifications subject to change without notice.

Order/Technical Support - Tel: (800) 677-5311 / FAX: (800) 677-3865 / www.crouzet-usa.com

D.C. geared motors with brushes

→ 5 Nm 3.9 Watts

A range of D.C. geared motors with solid metal gears.

- Mechanical rating of gearbox with output shaft stalled : 5 Nm.
- 3.9 Watt motor versions.
- Available in either 12 or 24 V D.C.
- Gearbox ratios options for 1.7 to 344 rpm.
- Interference suppression on standard products



Specifications

		3.9 Watts		3.9 watts
Type		82 867 0		82 867 0
Voltage		12 V		24 V
Output speed (rpm)	Ratios (i)			
344	12.5	82 867 001		82 867 007
258	50/3	82 867 0X16.67Z ●		82 867 0Y16.67Z ●
172	25	82 867 002		82 867 008
103	125/3	82 867 003		82 867 009
69	62.5	82 867 004		82 867 010
34	125	82 867 005		82 867 011
17	250	82 867 0X00250Z ●		82 867 0Y00250Z ●
8.6	500	82 867 006		82 867 012
1.72	2500	82 867 0X2500Z ●		82 867 0Y2500Z ●
General characteristics				
Motor		82 860 0		82 860 0
Gearbox		81 037 0		81 037 0
Maximum permitted torque from gearmotor under continuous conditions (for 1 millions turns) N.m		5		5
Axial load (dynamic) daN		2		2
Radial load (dynamic) daN		3		3
Max. output (W)		3.9		3.9
Nominal output (W)		3		3
Gearbox case temperature rise (°C)		50		50
Weight (g)		465		465

Products adaptations, available on request

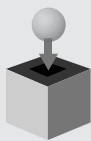

- Special supply voltages
- Special lead lengths
- Optional encoder
- Special connectors
- Special output shafts
- Special gearbox ratios
- Special gear material
- Special output bearings
- Special mounting plate

Products and specifications subject to change without notice.

Order/Technical Support - Tel: (800) 677-5311 / FAX: (800) 677-3865 / www.crouzet-usa.com

Curves

The shaded zone represents the operating range of the geared motor.
The horizontal line marks the maximum torque available in continuous duty cycle for a given life.
For higher torque ratings, service life will be reduced.

Nominal speed and torque curves
82 867 0

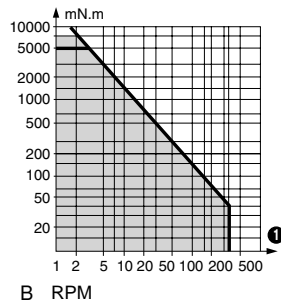

Dimensions

82 867 0

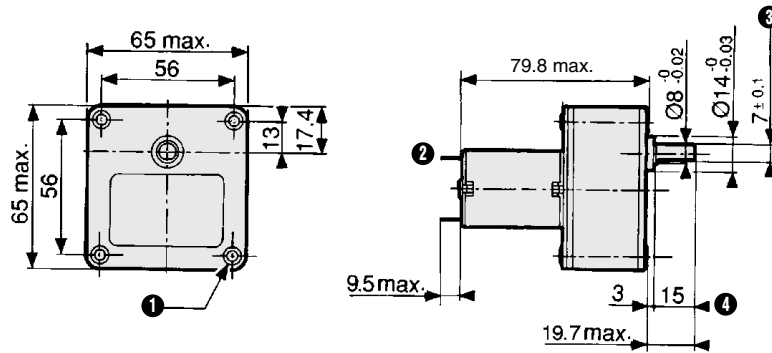

- B 4 fixing holes $\text{\O} \text{M4} \times 12 \text{ mm}$
- C 2 tags NFC 20-120 series $2.8 \times 0.5 \text{ mm}$
- D $7 \text{ mm} \pm 0.1$ across flats
- E (shaft pushed-in \leftarrow)

Options

Shaft 79 206 478

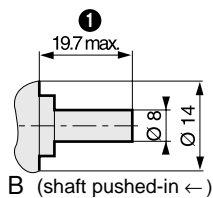

Products and specifications subject to change without notice.

Order/Technical Support - Tel: (800) 677-5311 / FAX: (800) 677-3865 / www.crouzet-usa.com

D.C. geared motors with brushes

→ 5 Nm 10 and 17 Watts

A range of D.C. geared motors with solid metal gears.

- Mechanical rating of gearbox with output shaft stalled : 5 Nm.
- 10 and 17 Watt motor power.
- Available in either 12, 24 or 48 V D.C.
- Gearbox ratios options for 10.5 to 616 rpm.



Specifications

	17 Watts	17 Watts	10 Watts	10 Watts	
Type	80 805 0	80 805 0	80 815 0	80 815 0	
Voltage	12 V	24 V	12 V	24 V	
Standard speed (rpm)	2600 rpm	2600 rpm	2600 rpm	2600 rpm	
Output speed (rpm)	Ratios (i)				
616	4.22	80 805 0X04.22Z ●	80 805 0Y04.22Z ●	80 815 0X04.22Z ●	80 815 0Y04.22Z ●
385	6.75	80 805 0X06.75Z ●	80 805 0Y06.75Z ●	80 815 0X06.75Z ●	80 815 0Y06.75Z ●
339.5	7.66	80 805 0X07.66Z ●	80 805 0Y07.66Z ●	80 815 0X07.66Z ●	80 815 0Y07.66Z ●
212	12.25	80 805 0X12.25Z ●	80 805 0Y12.25Z ●	80 815 0X12.25Z ●	80 815 0Y12.25Z ●
170	15.31	80 805 0X15.31Z ●	80 805 0Y15.31Z ●	80 815 0X15.31Z ●	80 815 0Y15.31Z ●
106	24.5	80 805 0X024.5Z ●	80 805 0Y024.5Z ●	80 815 0X024.5Z ●	80 815 0Y024.5Z ●
68	38.28	80 805 0X38.28Z ●	80 805 0Y38.28Z ●	80 815 0X38.28Z ●	80 815 0Y38.28Z ●
53	49	80 805 0X00049Z ●	80 805 0Y00049Z ●	80 815 0X00049Z ●	80 815 0Y00049Z ●
42.5	61.25	80 805 0X61.25Z ●	80 805 0Y61.25Z ●	80 815 0X61.25Z ●	80 815 0Y61.25Z ●
21	122.5	80 805 0X122.5Z ●	80 805 0Y122.5Z ●	80 815 0X122.5Z ●	80 815 0Y122.5Z ●
10.5	245	80 805 0X00245Z ●	80 805 0Y00245Z ●	80 815 0X00245Z ●	80 815 0Y00245Z ●
General characteristics					
Motor	82 800 0	82 800 0	82 810 0	82 810 0	
Gearbox	81 035 0	81 035 0	81 035 0	81 035 0	
Maximum permitted torque from gearmotor under continuous conditions (N.m)	5	5	5	5	
Axial load (dynamic) daN	6	6	6	6	
Radial load (dynamic) daN	6	6	6	6	
Max. output (W)	16.3	17	10.3	9.5	
Nominal output (W)	15.7	15.6	9.4	8.7	
Gearbox case temperature rise (°C)	44	40	45	46	
Weight (g)	920	920	820	820	

Products adaptations, available on request

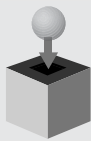

- Special supply voltages
- Special lead lengths
- Optional encoder
- Special connectors
- Special output shafts
- Special gearbox ratios
- Special gear material
- Special output bearings
- Special mounting plate

Products and specifications subject to change without notice.

Order/Technical Support - Tel: (800) 677-5311 / FAX: (800) 677-3865 / www.crouzet-usa.com

Curves

The shaded zone represents the operating range of the geared motor.
The horizontal line marks the maximum torque available in continuous duty cycle for a given life.
For higher torque ratings, service life will be reduced.

Nominal speed and torque curves
80 805 0

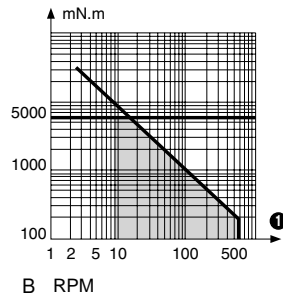

Nominal speed and torque curves
80 815 0

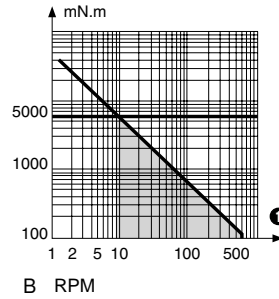

Dimensions

80 805 0

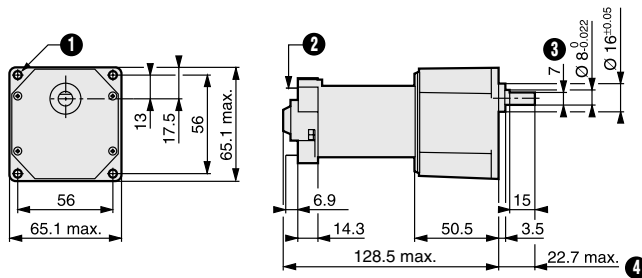

- B 4 fixing holes \varnothing 4.2
- C 2 tags IEC 760 series 4.8 x 0.5 mm
- D 7 mm \pm 0.1 across flats
- E (shaft pushed-in \leftarrow)

80 815 0 Standard

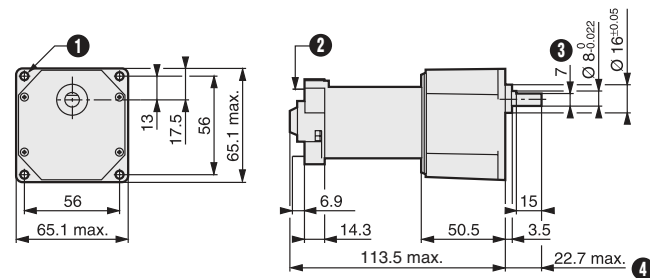

- B 4 fixing holes \varnothing 4.2
- C 2 tags IEC 760 series 4.8 x 0.5 mm
- D 7 mm \pm 0.1 across flats
- E (shaft pushed-in \leftarrow)

Options

Gearbox shaft 79 290 064

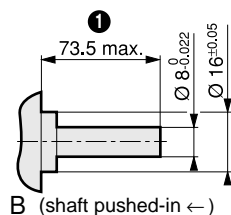

Products and specifications subject to change without notice.

Order/Technical Support - Tel: (800) 677-5311 / FAX: (800) 677-3865 / www.crouzet-usa.com

D.C. geared motors with brushes

→ 5 Nm 10 and 17 Watts

A range of D.C. geared motors with solid metal gears.

- Mechanical rating of gearbox with output shaft stalled : 5 Nm.
- 10 and 17 Watt motor power.
- Available in either 12, 24 or 48 V D.C.
- Gearbox ratios options for 1 to 208 rpm.



Specifications

		17 Watts	17 Watts	10 watts	10 Watts
Type		80 807 0	80 807 0	80 817 0	80 817 0
Voltage		12 V	24 V	12 V	24 V
Output speed (rpm)	Ratios (i)				
208	12.5	80 807 012	80 807 018	80 817 0X012.5Z ●	80 817 0Y012.5Z ●
156	50/3	80 807 0X16.67Z ●	80 807 0Y16.67Z ●	80 817 0X16.67Z ●	80 817 0Y16.67Z ●
104	25	80 807 013	80 807 019	80 817 0X00025Z ●	80 817 0Y00025Z ●
62	125/3	80 807 014	80 807 020	80 817 0X41.67Z ●	80 817 0Y41.67Z ●
42	62.5	80 807 015	80 807 021	80 817 0X062.5Z ●	80 817 0Y062.5Z ●
21	125	80 807 016	80 807 001	80 817 0X00125Z ●	80 817 0Y00125Z ●
10	250	80 807 0X00250Z ●	80 807 0Y00250Z ●	80 817 0X00250Z ●	80 817 0Y00250Z ●
5.20	500	80 807 017	80 807 022	80 817 0X00500Z ●	80 817 0Y00500Z ●
1.04	2500	80 807 0X2500Z ●	80 807 0Y02500Z ●	80 817 0X02500Z ●	80 817 0Y02500Z ●
General characteristics					
Motor		82 800 0	82 800 0	82 810 0	82 810 0
Gearbox		81 037 0	81 037 0	81 037 0	81 037 0
Maximum permitted torque from gearmotor under continuous conditions for 1 millions turns N.m		5	5	5	5
Axial load (dynamic) daN		2	2	2	2
Radial load (dynamic) daN		3	3	3	3
Max. output (W)		16.3	17	10.3	9.5
Nominal output (W)		15.7	15.6	9.4	8.7
Gearbox case temperature rise (°C)		44	40	45	46
Weight (g)		800	800	710	710

Products adaptations, available on request

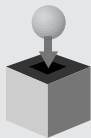

- Special supply voltages
- Special lead lengths
- Optional encoder
- Special connectors
- Special output shafts
- Special gearbox ratios
- Special gear material
- Special output bearings
- Special mounting plate

Products and specifications subject to change without notice.

Order/Technical Support - Tel: (800) 677-5311 / FAX: (800) 677-3865 / www.crouzet-usa.com

Curves

The shaded zone represents the operating range of the geared motor.
The horizontal line marks the maximum torque available in continuous duty cycle for a given life.
For higher torque ratings, service life will be reduced.

Nominal speed and torque curves
80 807 0

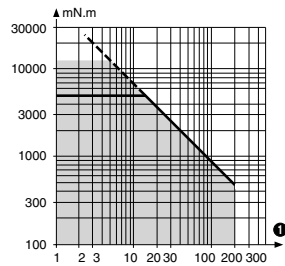

B RPM

Nominal speed and torque curves
80 817 0

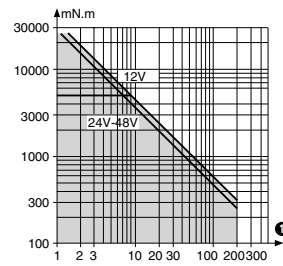

B RPM

Dimensions

80 807 0 Standard

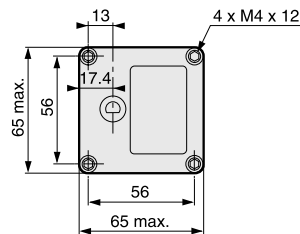

- B 2 tags IEC 760 series 4.8 x 0.5 mm
- C 7 mm across flats
- D (shaft pushed-in ←)

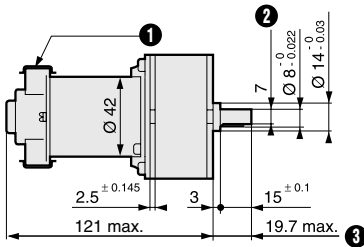

80 817 0 Standard

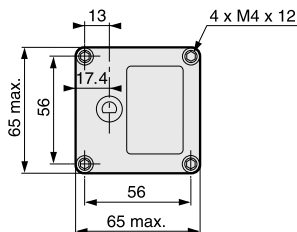

- B 2 tags IEC 760 series 4.8 x 0.5 mm
- C 7 mm across flats
- D (shaft pushed-in ←)

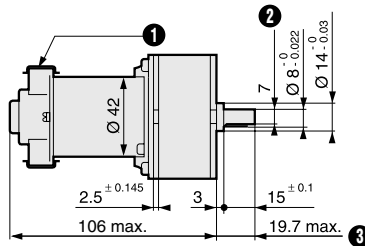

Options

Gearbox shaft 79 206 478

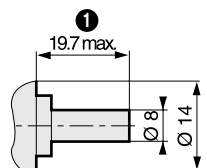

B (shaft pushed-in ←)

Products and specifications subject to change without notice.

Order/Technical Support - Tel: (800) 677-5311 / FAX: (800) 677-3865 / www.crouzet-usa.com

D.C. geared motors with brushes

→ 5 Nm 33 Watts

A range of D.C. geared motors with solid metal gears.

- Mechanical rating of gearbox with output shaft stalled : 5 Nm.
- 33 Watt motor power.
- Available in either 12, 24 or 48 V D.C.
- Gearbox ratios options for 7.4 to 426 rpm.



Specifications

		33 Watts	33 Watts
Type		80 835 0	80 835 0
Voltage		12 V	24 V
Standard speed (rpm)		1800 rpm	1800 rpm
Output speed (rpm)	Ratios (i)		
426	4.22	80 835 0X04.22Z ●	80 835 0Y04.22Z ●
266	6.75	80 835 012	80 835 009
235	7.66	80 835 0X07.66Z ●	80 835 0Y07.66Z ●
147	12.25	80 835 013	80 835 004
118	15.31	80 835 0X15.31Z ●	80 835 0Y15.31Z ●
73	24.5	80 835 014	80 835 002
47	38.28	80 835 015	80 835 003
37	49	80 835 0X00049Z ●	80 835 0Y00049Z ●
29.4	61.25	80 835 016	80 835 008
14.7	122.5	80 835 017	80 835 006
7.4	245	80 835 018	80 835 005
General characteristics			
Motor		82 830 0	82 830 0
Gearbox		81 035 0	81 035 0
Maximum permitted torque from gearmotor under continuous conditions (N.m)		5	5
Axial load (dynamic) daN		6	6
Radial load (dynamic) daN		6	6
Max. output (W)		33	33
Nominal output (W)		27	27
Gearbox case temperature rise (°C)		50	50
Weight (g)		1540	1540

Products adaptations, available on request

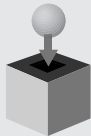

- Special supply voltages
- Special lead lengths
- Optional encoder
- Special connectors
- Special output shafts
- Special gearbox ratios
- Special gear material
- Special output bearings
- Special mounting plate

Products and specifications subject to change without notice.

Order/Technical Support - Tel: (800) 677-5311 / FAX: (800) 677-3865 / www.crouzet-usa.com

Curves

The shaded zone represents the operating range of the geared motor.
 The horizontal line marks the maximum torque available in continuous duty cycle for a given life.
 For higher torque ratings, service life will be reduced.

Nominal speed and torque curves

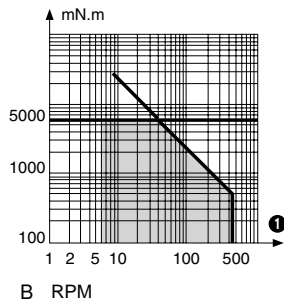

Dimensions

80 835 0

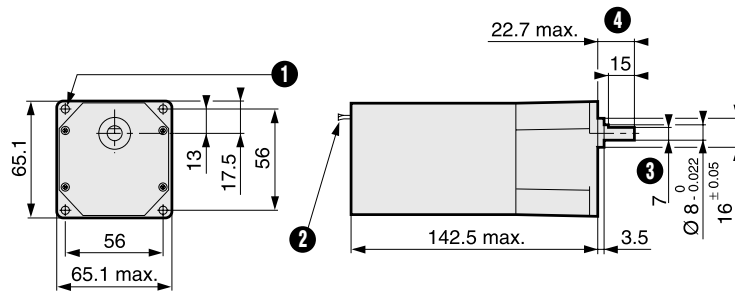

- B 4 fixing holes $\varnothing 4.2$
- C Lead length 200 mm ± 10
- D 7 mm across flats
- E (shaft pushed-in \leftarrow)

Options

Gearbox shaft 79 290 064

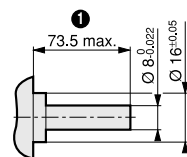

- B (shaft pushed-in \leftarrow)

Products and specifications subject to change without notice.

Order/Technical Support - Tel: (800) 677-5311 / FAX: (800) 677-3865 / www.crouzet-usa.com

D.C. geared motors with brushes

→ 5 Nm 40 to 52 Watts

A range of D.C. geared motors with solid metal gears.

- Mechanical rating of gearbox with output shaft stalled : 5 Nm.
- 40 to 52 Watt motor versions.
- Available in either 12 or 24 V D.C.
- Gearbox ratios options for 13.8 to 805 rpm.



Specifications

	42 Watts		52 Watts	
Type	80 855 0		80 855 0	
Voltages	12 V		24 V	
Standard speed (rpm)	3400 rpm		3400 rpm	
Output speed (rpm)	Ratios (i)			
805	4.22	80 855 0X04.22Z ●	80 855 0Y04.22Z ●	
503	6.75	80 855 0X06.75Z ●	80 855 0Y06.75Z ●	
444	7.66	80 855 0X07.66Z ●	80 855 0Y07.66Z ●	
277	12.25	80 855 0X12.25Z ●	80 855 0Y12.25Z ●	
222	15.31	80 855 0X15.31Z ●	80 855 0Y15.31Z ●	
139	24.5	80 855 0X024.5Z ●	80 855 0Y024.5Z ●	
89	38.28	80 855 0X38.28Z ●	80 855 0Y38.28Z ●	
69	49	80 855 0X0049Z ●	80 855 0Y0049Z ●	
55	61.25	80 855 0X61.25Z ●	80 855 0Y61.25Z ●	
28	122.5	80 855 0X122.5Z ●	80 855 0Y122.5Z ●	
13.8	245	80 855 0X00245Z ●	80 855 0Y00245Z ●	
General characteristics				
Motor	82 850 0		82 850 0	
Gearbox	81 035 0		81 035 0	
Maximum permitted torque from gearmotor under continuous conditions (2.5 million revolution) (N.m)	5		5	
Axial load (dynamic) daN	6		6	
Radial load (dynamic) daN	6		6	
Max. output (W)	42		52	
Nominal output (W)	32		32	
Gearbox case temperature rise (°C)	45		45	
Weight (g)	985		985	

Products adaptations, available on request

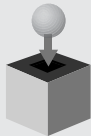

- Special supply voltages
- Special lead lengths
- Optional encoder
- Special connectors
- Special output shafts
- Special gearbox ratios
- Special gear material
- Special output bearings
- Special mounting plate

Products and specifications subject to change without notice.

Order/Technical Support - Tel: (800) 677-5311 / FAX: (800) 677-3865 / www.crouzet-usa.com

Curves

The shaded zone represents the operating range of the geared motor.
 The horizontal line marks the maximum torque available in continuous duty cycle for a given life.
 For higher torque ratings, service life will be reduced.

Nominal speed and torque curves

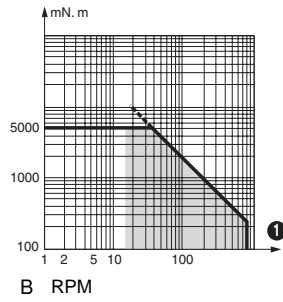

Dimensions

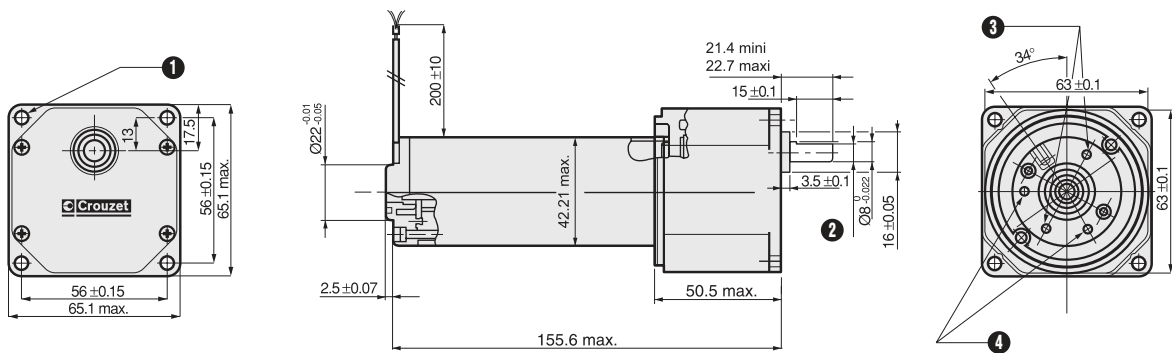

- B 4 fixing holes $\varnothing 4.2$
- C 7 mm ± 0.1 across flats
- D 2 holes M3 x 0.5 at 180° depth 4 on $\varnothing 32$
- E 2 holes 2.5 ± 0.5 at 120° depth 4.5 on $\varnothing 32$

Products and specifications subject to change without notice.

Order/Technical Support - Tel: (800) 677-5311 / FAX: (800) 677-3865 / www.crouzet-usa.com

D.C. geared motors with brushes

→ 6 Nm 10 and 17 Watts

A range of D.C. geared motors with solid metal gears.

- Mechanical rating of gearbox with output shaft stalled : 6 Nm.
- 10 and 17 Watt motor power.
- Available in either 12, 24 or 48 V D.C.
- Gearbox ratios options for 4 to 12 rpm.



Specifications

		10 Watts	10 Watts	17 Watts	17 Watts
Type		82 812 5	82 812 5	82 802 5	82 802 5
Voltage		12 V	24 V	12 V	24 V
Output speed (rpm)	Ratios (i)				
12	650/3	82 812 5X216.7Z ●	82 812 5Y216.7Z ●	82 802 5X216.7Z ●	82 802 5Y216.7Z ●
8	338	82 812 5X00338Z ●	82 812 5Y00338Z ●	82 802 5X00338Z ●	82 802 5Y00338Z ●
4	650	82 812 5X00650Z ●	82 812 5Y00650Z ●	82 802 5X00650Z ●	82 802 5Y00650Z ●
General characteristics					
Motor		82 810 0	82 810 0	82 800 0	82 800 0
Gearbox		81 032 6	81 032 6	81 032 6	81 032 6
Maximum permitted torque from gearmotor under continuous conditions for 10 millions turns N.m		6	6	6	6
Axial load (dynamic) daN		3.5	3.5	3.5	3.5
Radial load (dynamic) daN		5	5	5	5
Max. output (W)		10.3	9.5	16.3	17
Nominal output (W)		9.4	8.7	15.7	15.6
Gearbox case temperature rise (°C)		45	46	44	40
Weight (g)		880	880	880	880

Products adaptations, available on request

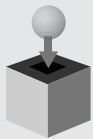

- Special supply voltages
- Special lead lengths
- Optional encoder
- Special connectors
- Special output shafts
- Special gearbox ratios
- Special gear material
- Special output bearings
- Special mounting plate

Products and specifications subject to change without notice.

Order/Technical Support - Tel: (800) 677-5311 / FAX: (800) 677-3865 / www.crouzet-usa.com

Curves

The shaded zone represents the operating range of the geared motor.
The horizontal line marks the maximum torque available in continuous duty cycle for a given life.
For higher torque ratings, service life will be reduced.

Nominal speed and torque curves
82 812 5

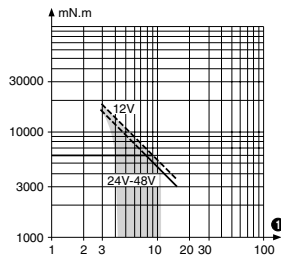

B RPM

Nominal speed and torque curves
82 802 5

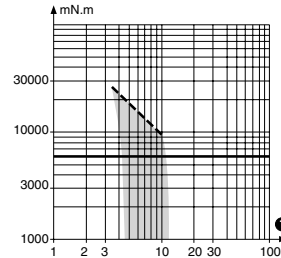

B RPM

Dimensions

82 812 5 Standard

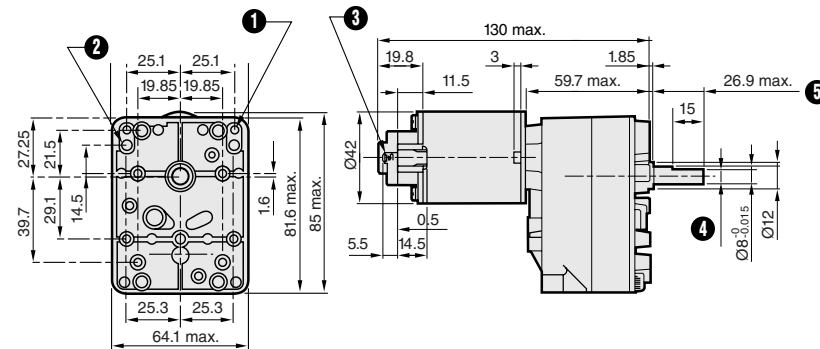

- B 8 holes M4 depth 7.5 mm
- C 3 holes M5 at 120° depth 7.5 mm
- D 2 tags IEC 760 series 4.8 x 0.5 mm
- E 7 mm across flats
- F (shaft pushed-in ←)

82 802 5 Standard

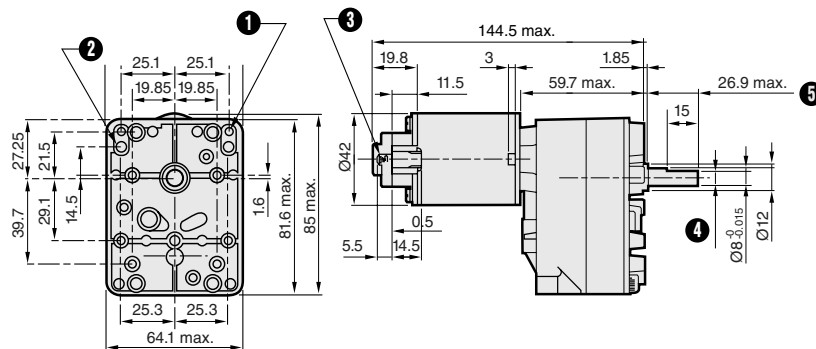

- B 8 holes M4 depth 7.5 mm
- C 3 holes M5 at 120° depth 7.5 mm
- D 2 tags IEC 760 series 4.8 x 0.5 mm
- E 7 mm across flats
- F (shaft pushed-in ←)

Products and specifications subject to change without notice.

Order/Technical Support - Tel: (800) 677-5311 / FAX: (800) 677-3865 / www.crouzet-usa.com

D.C. geared motors with brushes

→ 6 Nm 33 Watts

A range of D.C. geared motors with solid metal gears.

- Mechanical rating of gearbox with output shaft stalled : 6 Nm.
- 33 Watt motor power.
- Available in either 12, 24 or 48 V D.C.
- Gearbox ratios options for 5 to 14 rpm.



Specifications

		33 Watts		33 Watts
Type		82 832 5		82 832 5
Voltages		12 V		24 V
Output speed (rpm)	Ratios (i)			
14	130	82 832 5X00130Z ●		82 832 5Y00130Z ●
8	650/3	82 832 5X216.7Z ●		82 832 5Y216.7Z ●
5	338	82 832 5X00338Z ●		82 832 5Y00338Z ●
General characteristics				
Motor		82 830 0		82 830 0
Gearbox		81 032 6		81 032 6
Maximum permitted torque from gearmotor under continuous conditions for 10 millions turns N.m		6		6
Axial load (dynamic) daN		3.5		3.5
Radial load (dynamic) daN		5		5
Max. output (W)		33		33
Nominal output (W)		27		27
Gearbox case temperature rise (°C)		50		50
Weight (g)		1400		1400

Products adaptations, available on request

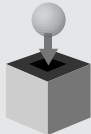

- Special supply voltages
- Special lead lengths
- Optional encoder
- Special connectors
- Special output shafts
- Special gearbox ratios
- Special gear material
- Special output bearings
- Special mounting plate

Products and specifications subject to change without notice.

Order/Technical Support - Tel: (800) 677-5311 / FAX: (800) 677-3865 / www.crouzet-usa.com

Curves

The shaded zone represents the operating range of the geared motor.
 The horizontal line marks the maximum torque available in continuous duty cycle for a given life.
 For higher torque ratings, service life will be reduced.

Nominal speed and torque curves

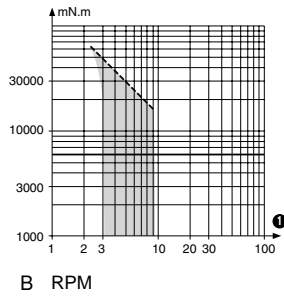

Dimensions

82 832 5

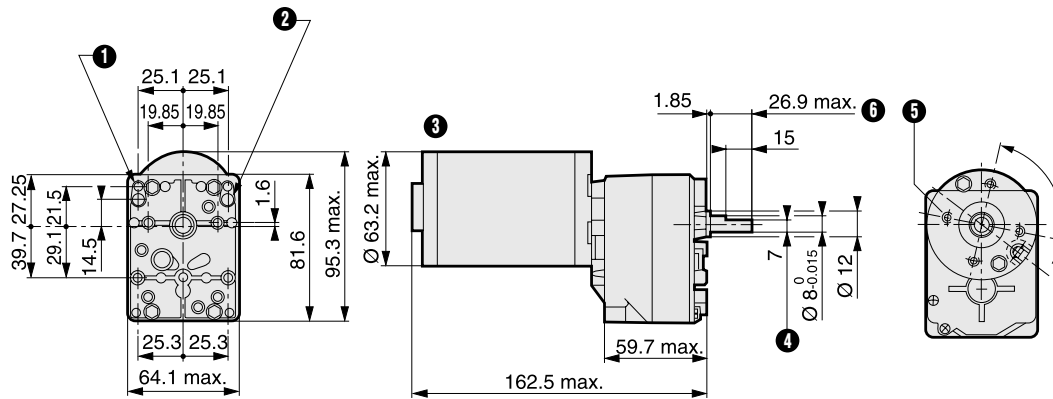

- B 3 holes M5 at 120° depth 7.5 mm
- C 8 holes M4 depth 7.5 mm
- D Lead length 200 mm
- E 7 mm across flats
- F 4 holes M5 on Ø 40 depth 7 mm
- G (shaft pushed-in ←)

Products and specifications subject to change without notice.

Order/Technical Support - Tel: (800) 677-5311 / FAX: (800) 677-3865 / www.crouzet-usa.com

D.C. geared motors with brushes

→ 50 Nm 22 to 42 Watts

- Gearbox torque rating : 0.8 to 25 Nm.
- Associated DC motors : 15 to 90 watts.
- DC planetary geared motors with brushes
- Speed range : 11 to 454 rpm.



Specifications

			22 Watts		42 Watts	
			80 809 2		80 859 3	
Type			12 V	24 V	12 V	24 V
Voltages						
Number of stages	Speed (rpm)	Ratios				
1	454	6.75	80 809 2X06.75 ●	80 809 2Y06.75 ●		
1	477	6.75			80 859 3X06.75 ●	80 859 3Y06.75 ●
2	122	25.0	80 809 2X00025 ●	80 809 2Y00025 ●		
2	128	25.0			80 859 3X00025 ●	80 859 3Y00025 ●
2	69	46	80 809 2X00046 ●	80 809 2Y00046 ●		
2	70	46			80 859 3X00046 ●	80 859 3Y00046 ●
3	33	93	80 809 2X00093 ●	80 809 2Y00093 ●		
3	34	93			80 859 3X00093 ●	80 859 3Y00093 ●
3	20	169	80 809 2X00169 ●	80 809 2Y00169 ●		
3	19	169			80 859 3X00169 ●	80 859 3Y00169 ●
3	12	308	80 809 2X00308 ●	80 809 2Y00308 ●		
3	11	308			80 859 3X00308 ●	80 859 3Y00308 ●
General characteristics						
Motor			82 800 5		82 850 0	
Gearbox			81 049 2		81 049 3	
Max. torque Nm			0.8 (1 stage) 2 (2 stages) 4 (3 stages)		3 (1 stage) 7.5 (2 stages) 15 (3 stages)	
Efficiency (%)			0.75 (1 stage) 0.7 (2 stages) 0.65 (3 stages)		0.8 (1 stage) 0.75 (2 stages) 0.7 (3 stages)	
Radial load (dynamic) daN			1.5 (1 stage) 3 (2 stages) 4.5 (3 stages)		16 (1 stage) 23 (2 stages) 30 (3 stages)	
Axial load (dynamic) daN			0.5 (1 stage) 1 (2 stages) 1.5 (3 stages)		5 (1 stage) 8 (2 stages) 11 (3 stages)	
Output ball bearing			No		Yes	
Sintered bronze output bearing			Yes		No	

Products adaptations, available on request

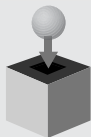

- Special supply voltages
- Special lead lengths
- Optional encoder
- Special connectors
- Special output shafts
- Special gearbox ratios
- Special gear material
- Special output bearings
- Special mounting plate

Products and specifications subject to change without notice.

Order/Technical Support - Tel: (800) 677-5311 / FAX: (800) 677-3865 / www.crouzet-usa.com

Curves

80 809 2

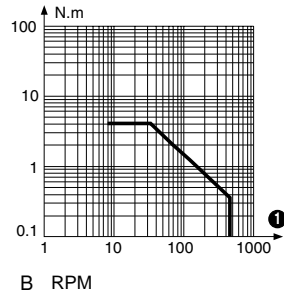

80 859 3

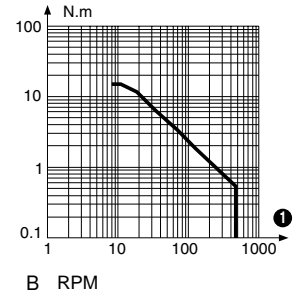

Dimensions

80 809 2

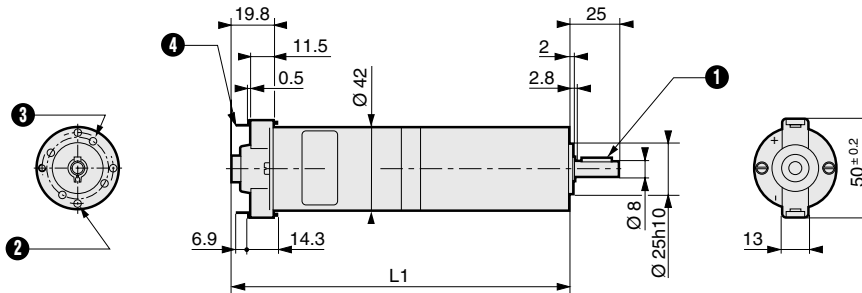

- B Key 3 x 3 x 16
- C 4 M4 x 10 on Ø 36
- D 4 holes for M3 self-tapping screws on Ø32, depth 10
- E 2 tags 4.75

- L1 1 stage : 134 mm
- L1 2 stages : 147 mm
- L1 3 stages : 160 mm

80 859 3

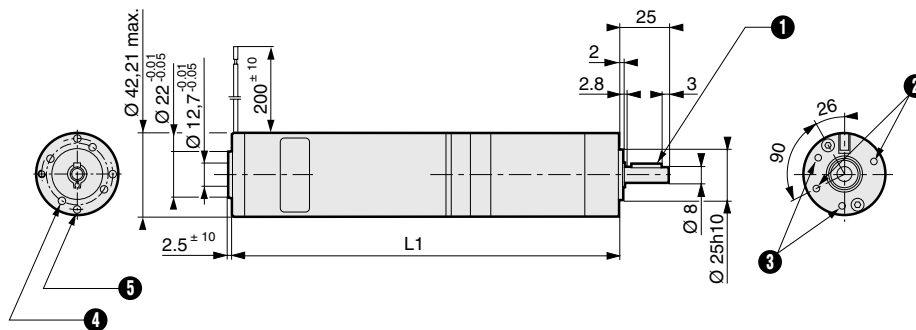

- B Key 3 x 3 x 16
- C 2 M3 x 0.5 at 180° depth 5.5 on Ø32
- D 2 M3 x 0.5 at 120° depth 5.5 on Ø32
- E 4 M4 x 10 on Ø36
- F 4 M3 x 10 on Ø32

- L1 1 stage : 162 mm
- L1 2 stages : 175 mm
- L1 3 stages : 188 mm

Products and specifications subject to change without notice.

Order/Technical Support - Tel: (800) 677-5311 / FAX: (800) 677-3865 / www.crouzet-usa.com

D.C. geared motors with brushes

→ 50 Nm 67 to 195 Watts

- Gearbox torque rating : 0.8 to 25 Nm.
- Associated DC motors : 15 to 90 watts.
- DC planetary geared motors with brushes
- Speed range : 11 to 454 rpm.



Specifications

			67 Watts		195 Watts	
			80 839 4		80 899 5	
Type			12 V	24 V	24 V	48 V
Voltages						
Number of stages	Speed (rpm)	Ratios				
1	410	6.75	80 839 4X06.75 ●	80 839 4Y06.75 ●		
1	474	6.75			80 899 5X06.75 ●	80 899 5Z06.75 ●
2	110	25.0	80 839 4X00025 ●	80 839 4Y00025 ●		
2	128	25.0			80 899 5X00025 ●	80 899 5Z00025 ●
2	62	46	80 839 4X00046 ●	80 839 4Y00046 ●		
2	70	46			80 899 5X00046 ●	80 899 5Z00046 ●
3	30	93	80 839 4X00093 ●	80 839 4Y00093 ●		
3	34	93			80 899 5X00093 ●	80 899 5Z00093 ●
3	18	169	80 839 4X00169 ●	80 839 4Y00169 ●		
3	19	169			80 899 5X00169 ●	80 899 5Z00169 ●
3	11	308	80 839 4X00308 ●	80 839 4Y00308 ●		
3	11	308			80 899 5X00308 ●	80 899 5Z00308 ●

General characteristics

	82 830 5	82 890 0
Motor	82 830 5	82 890 0
Gearbox	81 049 4	82 849 5
Max. torque Nm	2 (1 stage) 5 (2 stages) 10 (3 stages)	4 (1 stage) 12 (2 stages) 25 (3 stages)
Efficiency (%)	0.75 (1 stage) 0.7 (2 stages) 0.65 (3 stages)	0.8 (1 stage) 0.75 (2 stages) 0.7 (3 stages)
Radial load (dynamic) daN	20 (1 stage) 32 (2 stages) 45 (3 stages)	20 (1 stage) 32 (2 stages) 45 (3 stages)
Axial load (dynamic) daN	6 (1 stage) 10 (2 stages) 15 (3 stages)	6 (1 stage) 10 (2 stages) 15 (3 stages)
Output ball bearing	Yes	Yes
Sintered bronze output bearing	No	No

Products adaptations, available on request

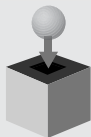

- Special supply voltages
- Special lead lengths
- Optional encoder
- Special connectors
- Special output shafts
- Special gearbox ratios
- Special gear material
- Special output bearings
- Special mounting plate

Products and specifications subject to change without notice.

Order/Technical Support - Tel: (800) 677-5311 / FAX: (800) 677-3865 / www.crouzet-usa.com

Curves

80 839 4

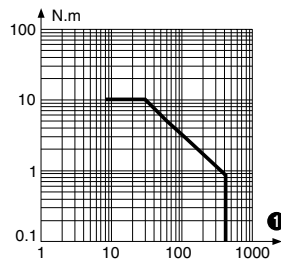

B RPM

80 899 5

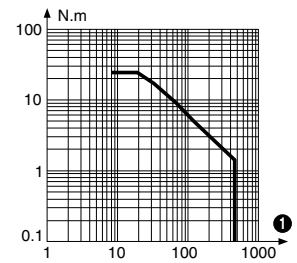

B RPM

Dimensions

80 839 4

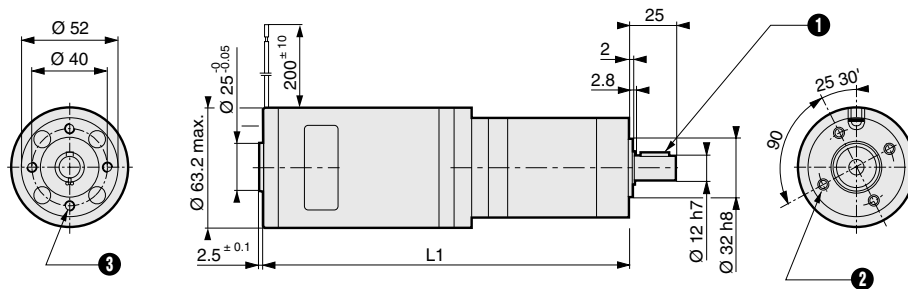

B Key 4 x 4 x 16

C 4 M5 x 0.86 h depth 7 on Ø 40

D 4 M5 x 10

L1 1 stage : 159 mm

L1 2 stages : 173 mm

L1 3 stages : 187 mm

80 899 5

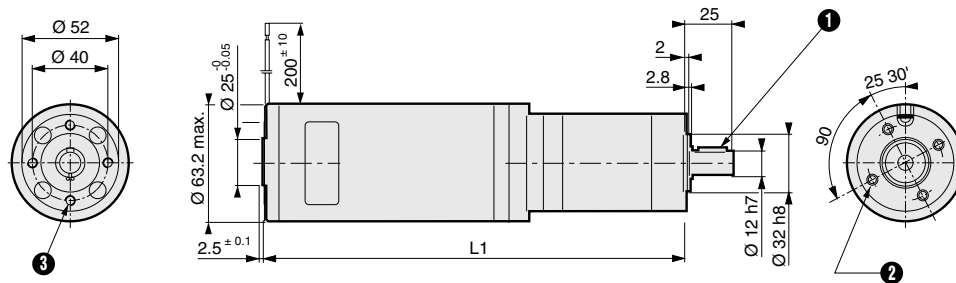

B Key 4 x 4 x 16

C 4 M5 x 0.86 h depth 7 on Ø 40

D 4 M5 x 10

L1 1 stage : 184 mm

L1 2 stages : 198 mm

L1 3 stages : 212 mm

Products and specifications subject to change without notice.

Order/Technical Support - Tel: (800) 677-5311 / FAX: (800) 677-3865 / www.crouzet-usa.com

Magnetic Encoder

- For motors: 82 800 0 - 82 810 0 - 82 800 5 - 82 810 5 - 82 860
- For geared motors: 80 813 0 - 80 814 0 - 80 803 0 - 80 804 0 - 82 842 5 - 82 842 6 - 82 862 5 - 82 862 6

Magnetic encoders, resolution of 1 pulse per revolution

Technology

A magnetic wave is generated by a magnet integrated in the motor shaft. A Hall effect sensor reads this information and converts it into a square wave within the motor.

General layout

Vdc from .4 to 24 volts - current: 50 mA

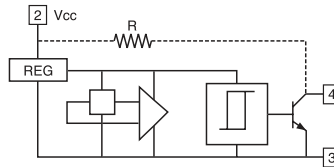

Output Signal

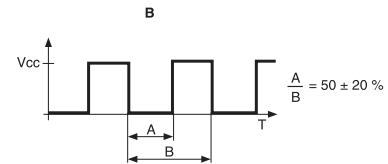

82 800 0 - 82 810 0 - 82 800 5 - 82 810 5 - 80 313 0 - 80 814 0 - 80 803 0 - 80 604 0

Applications

- Measuring systems for feed dispensing equipment
- Position settings for automatic access points
- Servomotors
- Magnetic encoder gives resolution of 5 pulses per revolution

Connections - Motor and encoder power supplies must be kept separate

- 1 - Motor Supply +
- 2 - Encoder supply +
- 3 - Encoder ground
- 4 - Encoder output ~
- 5 - Motor ground

- 1- An integrated connector HE14 / 2.54 mm is used for motor and encoder power supplies and encoder output signals.
- 2 - Resistance R should be added (Value depends on Vdc)
- 3- Recommended customer connectors : STOCKO MKF 17-230/260/330/360 - LUMBERG 2.5 MBX

Made to order products,
available on request

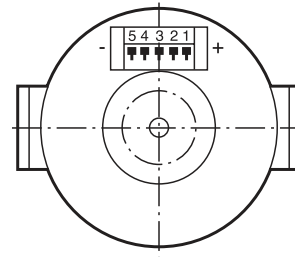

82 860 - 82 842 5 - 82 842 6 - 82 862 5 - 82 862 6

Applications

- Positioning dental radiology equipment
- Adjusting Venetian blinds
- Measuring systems for coffee machines
- Magnetic encoder with a resolution of 5 or 12 pulses per revolution

Connections - Motor and encoder power supplies must be kept separate

- 1 - + Motor supply output tag
- 2 - - Motor supply output tag
- 3 - Brown wire for + Vdc encoder supply
- 4 - Yellow wire for encoder signal
- 5 - Blue wire for encoder ground

- 1 - Encoder power supply and signal : lead length 135 mm
- 2 - Resistance R should be added (Value depends on Vdc)
- 3 - Standard motors 82 860 5 with magnetic encoders are equipped with interference suppression

Made to order products,
available on request

Products and specifications subject to change without notice.

Order/Technical Support - Tel: (800) 677-5311 / FAX: (800) 677-3865 / www.crouzet-usa.com

Friction clutch for 81 021

This device is situated inside the gearbox and is particularly recommended when gearbox protection is required if accidental overloading occurs.
In this system, the final gear is connected to the gearbox output shaft by means of a friction assembly.
In some cases, this device can be used for time adjustment or zero reset on timers.
The standard torque setting is : 1.8 to 2.5 cm/kg for gearbox 81 021

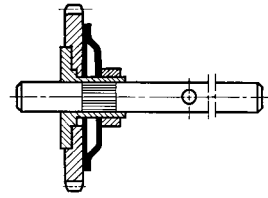

Needle Bearings for 81 032

Where operating conditions are severe, e.g. where there are high radial or alternating loads, it is advisable for needle bearings to be substituted for the normal bearings.
Please consult us.
Note: applies to 81 032 gearboxes only.

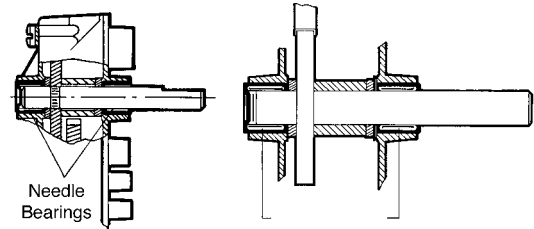

Cover 2 for 81 032

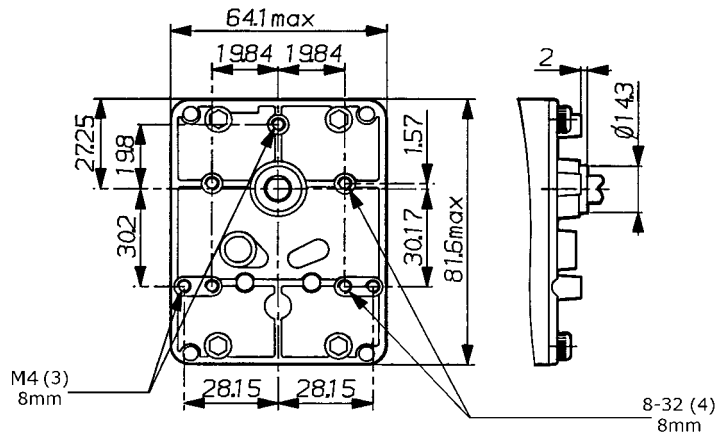

Products and specifications subject to change without notice.

Order/Technical Support - Tel: (800) 677-5311 / FAX: (800) 677-3865 / www.crouzet-usa.com