

## FEATURES

- Halts and restarts an out-of-control microprocessor
- Holds microprocessor in check during power transients
- Automatically restarts microprocessor after power failure
- Monitors pushbutton for external override
- Accurate 5%, 10%, or 20% (3V only) microprocessor power monitoring
- Eliminates the need for discrete components
- 20% tolerance for use with 3.0V systems
- Pin- and function-compatible with the MAX823/24/25 products
- Low cost SOT-23-5 package
- Industrial temperature range: -40°C to +85°C

DEVICE	$\overline{\text{RST}}$	RST	$\overline{\text{PBRST}}$	WD
DS181xA	X		X	X
DS181xB	X	X		X
DS181xC	X	X	X	

x = "DS1814" for 5V devices

x = "DS1819" for 3V devices

## PIN ASSIGNMENT

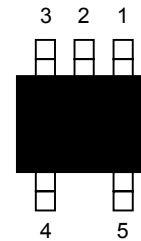

SOT-23-5 PACKAGE  
See Mech. Drawing

## PIN DESCRIPTION

### DS181xA

- |   |                           |                         |
|---|---------------------------|-------------------------|
| 1 | $\overline{\text{RST}}$   | Active Low Reset Output |
| 2 | GND                       | Ground                  |
| 3 | $\overline{\text{PBRST}}$ | Pushbutton Reset Input  |
| 4 | $\overline{\text{ST}}$    | Strobe Input            |
| 5 | VCC                       | Power Supply            |

### DS181xB

- |   |                         |                          |
|---|-------------------------|--------------------------|
| 1 | $\overline{\text{RST}}$ | Active Low Reset Output  |
| 2 | GND                     | Ground                   |
| 3 | RST                     | Active High Reset Output |
| 4 | $\overline{\text{ST}}$  | Strobe Input             |
| 5 | VCC                     | Power Supply             |

### DS181xC

- |   |                           |                          |
|---|---------------------------|--------------------------|
| 1 | $\overline{\text{RST}}$   | Active Low Reset Output  |
| 2 | GND                       | Ground                   |
| 3 | RST                       | Active High Reset Output |
| 4 | $\overline{\text{PBRST}}$ | Pushbutton Reset Input   |
| 5 | VCC                       | Power Supply             |

## DESCRIPTION

The DS1814 5-Volt MicroMonitor and the DS1819 3.3V MicroMonitor monitor three vital conditions for a microprocessor: power supply, software execution, and external override. First, a precision temperature-compensated reference and comparator circuit monitor the status of  $V_{CC}$ . When an out-of-tolerance condition occurs, an internal power-fail signal is generated which forces the reset(s) to an active state. When  $V_{CC}$  returns to an in-tolerance condition, the reset signal is kept in the active state for a minimum of 140ms to allow the power supply and processor to stabilize.

The DS1814/DS1819 'A' and 'C' perform pushbutton reset control. They debounce the pushbutton input and generate an active reset pulse width of 140ms minimum. The DS1814/9 'A' and 'B' versions perform a watchdog function. The watchdog is an internal timer that forces the reset signals to the active state if the strobe input does not change state every 1.12 seconds. The watchdog timer function can be disabled by leaving the watchdog strobe input disconnected.

## OPERATION

### Power Monitor

The DS1814 detects out-of-tolerance power supply conditions and warns a processor-based system of impending power failure. When  $V_{CC}$  falls below a preset level, a comparator outputs the signal  $\overline{RST}$  (or RST).  $\overline{RST}$  (or RST) are excellent control signals for a microprocessor, as processing is stopped at the last possible moment of valid  $V_{CC}$ . On power-up,  $\overline{RST}$  (or RST) are kept active for a minimum of 140ms to allow the power supply and processor to stabilize.

### Pushbutton Reset

The DS1814 'A' and 'C' provide an input pin for direct connection to a pushbutton reset (see Figure 2). The pushbutton reset input requires an active low signal. Internally, this input is debounced and timed such that a  $\overline{RST}$  (or RST) signal of at least 140ms minimum will be generated. The 140ms delay commences as the pushbutton reset input is released from the low level (see Figure 3).

### Watchdog Timer

The DS1814/DS1819 'A' and 'B' versions watchdog timer function forces  $\overline{RST}$  (and RST) signal(s) active when the  $\overline{ST}$  input is not clocked within the 1.12 second watchdog time-out period. Time-out of the watchdog starts when  $\overline{RST}$  (and RST) become(s) inactive. If a transition occurs on the  $\overline{ST}$  input pin prior to time-out, the watchdog timer is reset and begins to time out again. If the watchdog timer is allowed to time out, then the reset output(s) will go active for 140ms. The watchdog can be disabled by floating (or tri-stating) the  $\overline{ST}$  input.

The  $\overline{ST}$  input can be derived from many microprocessor outputs. The most typical signals used are the microprocessor data I/O signals and control signals. When the microprocessor functions normally, these signals would as a matter of routine cause the watchdog to be reset prior to time-out. To guarantee that the watchdog timer does not time out, a transition must occur at or less than 1.12 seconds. A typical circuit example is shown in Figure 4. The DS1814/19 watchdog function can be disabled at any time by tri-starting the strobe input. A sample circuit to disable the watchdog is shown in Figure 6.

**DS1814/DS1819 BLOCK DIAGRAM Figure 1**

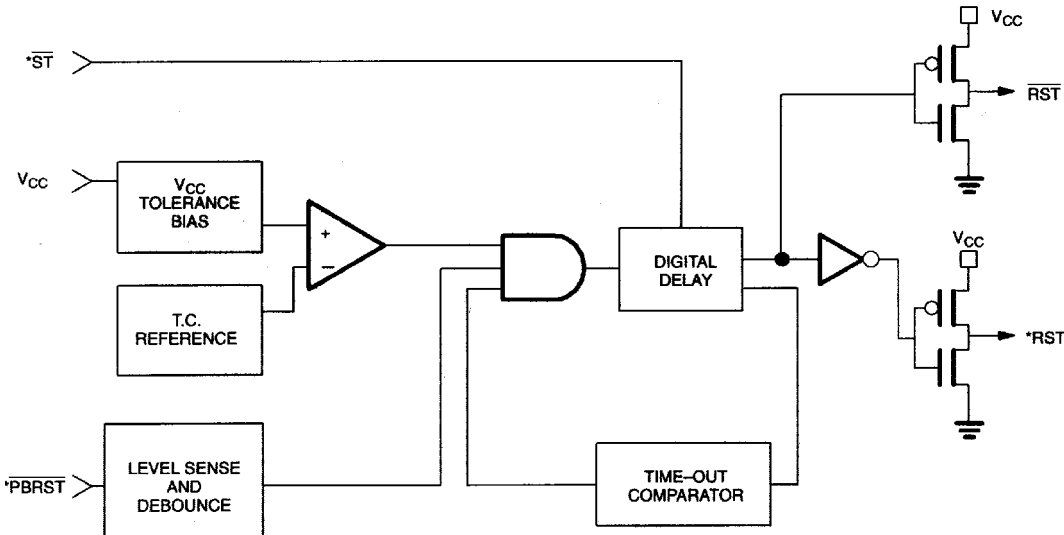

**\*Notes:**

- ST available on 'A' and 'B' versions
- PBRST available on 'A' and 'C' versions
- RST available on 'B' and 'C' versions

**PUSHBUTTON RESET Figure 2**

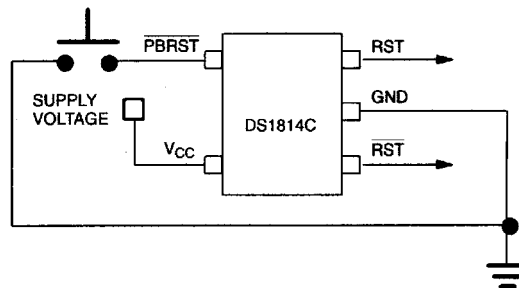

**TIMING DIAGRAM: PUSHBUTTON RESET Figure 3**

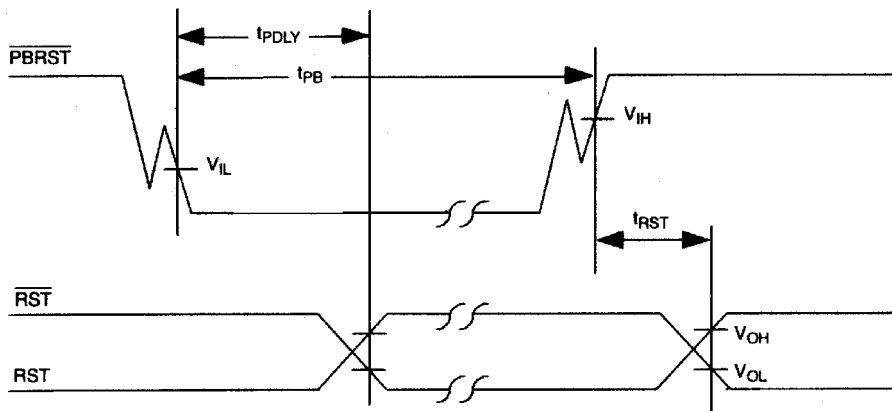

**WATCHDOG TIMER Figure 4**



**TIMING DIAGRAM: STROBE INPUT Figure 5**



**WATCHDOG DISABLE CIRCUIT Figure 6**



**TIMING DIAGRAM: POWER-DOWN Figure 7**

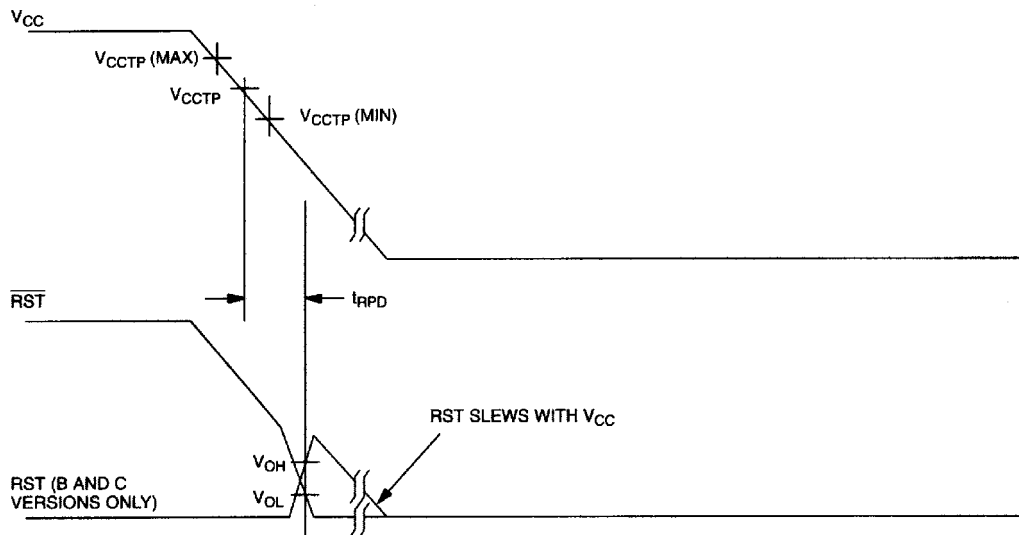

## TIMING DIAGRAM: POWER-UP Figure 8

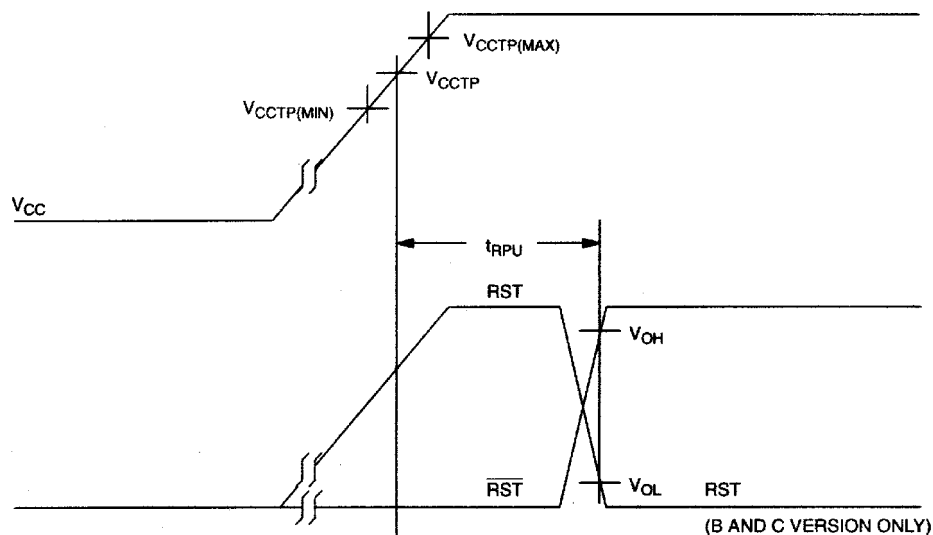

## $\overline{RST}$ VALID TO 0 VOLTS $V_{CC}$ Figure 9

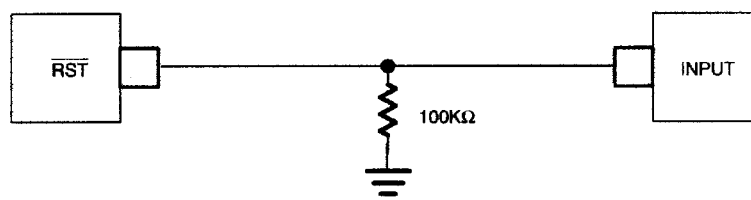

## OUTPUT VALID CONDITIONS

The  $\overline{RST}$  output uses a push-pull output which can maintain a valid output down to 1.0V  $V_{CC}$ . To sink current below 1.0V a resistor can be connected from  $\overline{RST}$  to Ground (see Figure 9.) This arrangement will maintain a valid value on  $\overline{RST}$  during both power-up and -down but will draw current when  $\overline{RST}$  is in the high state. A value of about 100kΩ should be adequate in most situations. The output with a resistor pull-down can maintain a valid reset down to  $V_{CC}$  equal to 0V.

**ABSOLUTE MAXIMUM RATINGS\***

Voltage on $V_{CC}$ Pin Relative to Ground	-0.5V to +7.0V
Voltage on I/O Relative to Ground	-0.5V to $V_{CC} + 0.5V$
Operating Temperature Range	-40°C to +85°C
Storage Temperature Range	-55°C to +125°C
Soldering Temperature	260°C for 10 seconds

\* This is a stress rating only and functional operation of the device at these or any other conditions above those indicated in the operation sections of this specification is not implied. Exposure to absolute maximum rating conditions for extended periods of time may affect reliability.

**RECOMMENDED DC OPERATING CONDITIONS** (-40°C to +85°C)

PARAMETER	SYMBOL	MIN	TYP	MAX	UNITS	NOTES
Supply Voltage	$V_{CC}$	1.0		5.5	V	1
$\overline{ST}$ and $\overline{PBRST}$ Input High Level	$V_{IH}$	0.8 $V_{CC}$			V	1
$\overline{ST}$ and $\overline{PBRST}$ Input Low Level	$V_{IL}$			0.3 $V_{CC}$	V	1

**DC ELECTRICAL CHARACTERISTICS** (-40°C to +85°C;  $V_{CC} = 1.2V$  to 5.5V)

PARAMETER	SYMBOL	MIN	TYP	MAX	UNITS	NOTES
$V_{CC}$ Trip Point DS1814-5	$V_{CCTP}$	4.50		4.75	V	1
$V_{CC}$ Trip Point DS1814-10	$V_{CCTP}$	4.25		4.50	V	1
$V_{CC}$ Trip Point DS1819-5	$V_{CCTP}$	3.00		3.15	V	1
$V_{CC}$ Trip Point DS1819-10	$V_{CCTP}$	2.85		3.00	V	1
$V_{CC}$ Trip Point DS1819-20	$V_{CCTP}$	2.55		2.70	V	1
Reset Trip Point Hysteresis (DS1814)	$V_{RH}$		10		mV	
Reset Trip Point Hysteresis (DS1819)	$V_{RH}$		5		mV	
Output Current @ 2.4V	$I_{OH}$		350		$\mu A$	3
Output Current @ 0.4V	$I_{OL}$	3.2	6		mA	3
Output Voltage @ -30 $\mu A$	$V_{OH}$	$V_{CC} \cdot 0.8$	$V_{CC} \cdot 0.9$		V	3
Operating Current DS1814	$I_{CC}$		10	15	$\mu A$	4
Operating Current DS1819	$I_{CC}$		8	12	$\mu A$	5
$\overline{ST}$ Input Current $\overline{ST} = V_{CC}$ , Time Averaged			120	160	$\mu A$	6
$\overline{ST}$ Input Current $\overline{ST} = GND$ , Time Averaged		-20	-15		$\mu A$	6

**AC ELECTRICAL CHARACTERISTICS** (-40°C to +85°C;  $V_{CC} = 1.2V$  to  $5.5V$ )

PARAMETER	SYMBOL	MIN	TYP	MAX	UNITS	NOTES
$\overline{PBRST} = V_{IL}$	$t_{PB}$	1			$\mu s$	7
Reset Active Time	$t_{RST}$	140	200	280	ms	
$\overline{ST}$ Pulse Width	$t_{ST}$	50			ns	8
Watchdog Time-out	$t_{TD}$	1.12	1.60	2.40	s	
$V_{CC}$ Detect to RST and $\overline{RST}$	$t_{RPD}$		30	40	$\mu s$	9
$V_{CC}$ Slew Rate (rising edge)			12.5		V/ $\mu s$	
$V_{CC}$ Detect to RST and $\overline{RST}$	$t_{RPU}$	140	200	280	ms	
$\overline{PBRST}$ Stable Low to RST and $\overline{RST}$	$t_{PDLY}$		500		ns	

**CAPACITANCE** $(t_A = 25^\circ C)$ 

PARAMETER	SYMBOL	MIN	TYP	MAX	UNITS	NOTES
Input Capacitance	$C_{IN}$			5	pF	
Output Capacitance	$C_{OUT}$			7	pF	

**NOTES:**

- 1) All voltages are referenced to ground.
- 2)  $\overline{PBRST}$  is internally pulled up to  $V_{CC}$  with an internal impedance of  $50k\Omega$  typical.
- 3) Measured with  $V_{CC} \geq 2.7V$ .
- 4) Measured with outputs open,  $V_{CC} \leq 5.5V$ , and all inputs at  $V_{CC}$  or Ground, except the  $\overline{ST}$  input at  $<10kHz$  duty cycle-square wave or  $\overline{ST}$  input open.
- 5) Measured with outputs open,  $V_{CC} \leq 3.6V$ , and all inputs at  $V_{CC}$  or Ground, except the  $\overline{ST}$  input at  $<10kHz$  duty cycle-square wave or  $\overline{ST}$  input open.
- 6) The  $\overline{ST}$  input current is defined as the average input current when  $\overline{ST}$  is driven high or low. This input must be driven high or low by an output that can source or sink at least  $200\mu A$  when active.
- 7) Noise immunity: pulses  $<100ns$  at pushbutton input will not cause a reset.
- 8) Must not exceed  $t_{TD}$  minimum.
- 9) Noise immunity: pulses  $<2\mu s$  at  $V_{CCTP}$  minimum will not cause a reset and  $V_{CCTP} - V_{CC} = 100mV$ .

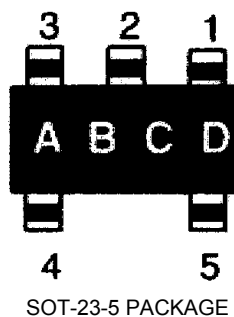
**PART MARKING CODES**

‘A’, ‘B’ and ‘C’ represents the Device Type.

‘D’ represents the Device Tolerance.

14A	-	DS1814A
14B	-	DS1814B
14C	-	DS1814C
19A	-	DS1819A
19B	-	DS1819B
19C	-	DS1819C

A	-	5%
B	-	10%
C	-	20%