

SP3130 Series 0.3pF 10KV Bidirectional Discrete TVS

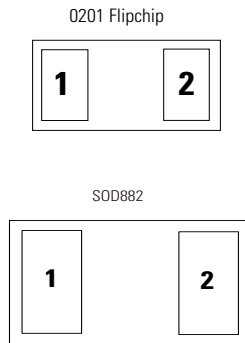

Pinout



Description

The SP3130 includes back-to-back TVS diodes fabricated in a proprietary silicon avalanche technology to provide protection for electronic equipment that may experience destructive electrostatic discharges (ESD). These robust diodes can safely absorb repetitive ESD strikes up to the maximum level specified in the IEC 61000-4-2 international standard without performance degradation. The back-to-back configuration provides symmetrical ESD protection for data lines when AC signals are present.

Features

- ESD protection of $\pm 10\text{kV}$ contact discharge, $\pm 15\text{kV}$ air discharge, (IEC 61000-4-2)
- EFT protection, IEC 61000-4-4, 40A ($t_p=5/50\text{ns}$)
- Lightning Protection, IEC 61000-4-5 2nd edition, 2A ($t_p=8/20\mu\text{s}$)
- Low capacitance of 0.3pF @ $V_R=0\text{V}$
- Low leakage current of 50nA (max) at 28V
- Space efficient 0201 and 0402 footprint
- Halogen free, Lead free and RoHS compliant
- AEC-Q101 qualified (SOD882)

Functional Block Diagram



Applications

- Tablets
- Ultrabook
- eReader
- Smart Phones
- Digital Cameras
- MP3/ PMP
- Set Top Boxes
- Portable Medical
- NFC and FeliCa

Absolute Maximum Ratings

Symbol	Parameter	Value	Units
I_{PP}	Peak Current ($t_p=8/20\mu s$)	2.0	A
T_{OP}	Operating Temperature	-40 to 125	°C
T_{STOR}	Storage Temperature	-55 to 150	°C

CAUTION: Stresses above those listed in "Absolute Maximum Ratings" may cause permanent damage to the device. This is a stress only rating and operation of the device at these or any other conditions above those indicated in the operational sections of this specification is not implied.

Thermal Information

Parameter	Rating	Units
Storage Temperature Range	-55 to 150	°C
Maximum Lead Temperature (Soldering 20-40s)	260	°C

Electrical Characteristics ($T_{OP}=25^\circ C$)

Parameter	Symbol	Test Conditions	Min	Typ	Max	Units
Reverse Standoff Voltage	V_{RWM}				28	V
Reverse Leakage Current	I_{LEAK}	$V_R=28V$ with 1 pin at GND		10	50	nA
Clamp Voltage ¹	V_C	$I_{PP}=1A, t_p=8/20\mu s$, Fwd		39	44	V
		$I_{PP}=2A, t_p=8/20\mu s$, Fwd		42	48	V
ESD Withstand Voltage ¹	V_{ESD}	IEC61000-4-2 (Contact)	± 10			kV
		IEC61000-4-2 (Air)	± 15			kV
Dynamic Resistance ²	R_{DYN}	TLP, $t_p=100ns$, I/O to GND		1.0		Ω
Diode Capacitance ¹	$C_{I/O-I/O}$	Reverse Bias=0V, $f=1$ MHz		0.3	0.45	pF

Note: 1. Parameter is guaranteed by design and/or device characterization.

2. Transmission Line Pulse (TLP) with 100ns width, 2ns rise time, and average window $t_1=70ns$ to $t_2=90ns$

8/20 μs Pulse Waveform

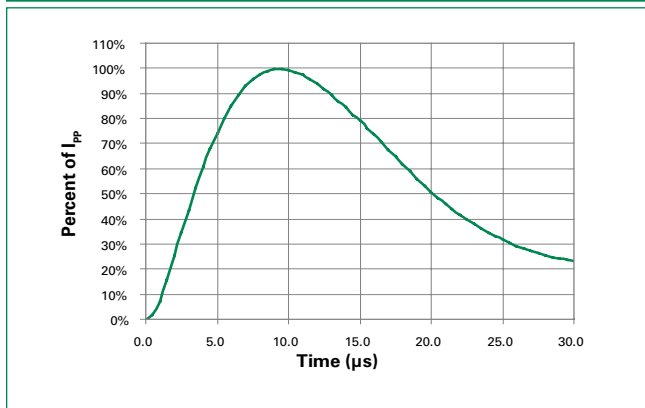

Capacitance vs. Reverse Bias

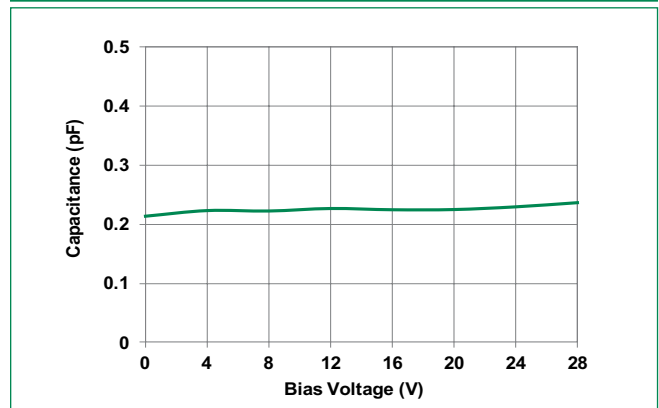

Transmission Line Pulsing (TLP) Plot

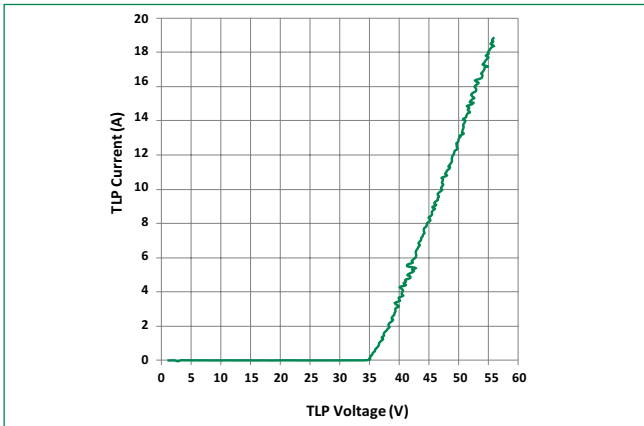

Insertion Loss (S21)

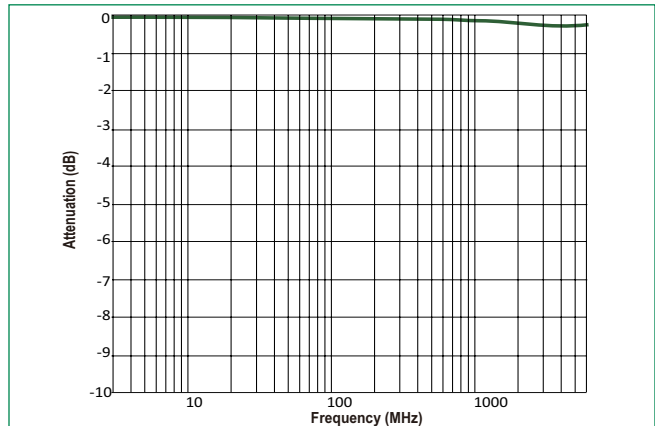

Soldering Parameters

Reflow Condition		Pb – Free assembly
Pre Heat	- Temperature Min ($T_{s(min)}$)	150°C
	- Temperature Max ($T_{s(max)}$)	200°C
	- Time (min to max) (t_s)	60 – 180 secs
Average ramp up rate (Liquidus) Temp (T_L) to peak		3°C/second max
$T_{s(max)}$ to T_L - Ramp-up Rate		3°C/second max
Reflow	- Temperature (T_L) (Liquidus)	217°C
	- Temperature (t_L)	60 – 150 seconds
Peak Temperature (T_p)		260 ^{+0/-5} °C
Time within 5°C of actual peak Temperature (t_p)		20 – 40 seconds
Ramp-down Rate		6°C/second max
Time 25°C to peak Temperature (T_p)		8 minutes Max.
Do not exceed		260°C

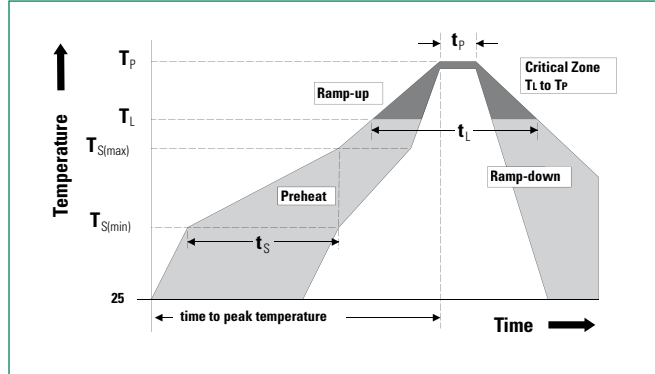

Part Numbering System

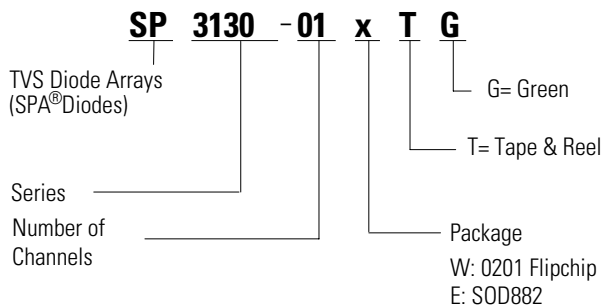

Product Characteristics of 0201 Flipchip

Lead Plating	Sn
Lead Material	Copper
Lead Coplanarity	6µm(max)
Substrate material	Silicon
Body Material	Silicon

Product Characteristics of SOD882

Lead Plating	Pre-Plated Frame
Lead Material	Copper Alloy
Lead Coplanarity	0.004 inches(0.102mm)
Substrate material	Silicon
Body Material	Molded Epoxy
Flammability	UL 94 V-0

Notes :

1. All dimensions are in millimeters
2. Dimensions include solder plating.
3. Dimensions are exclusive of mold flash & metal burr.
4. Blo is facing up for mold and facing down for trim/form, i.e. reverse trim/form.
5. Package surface matte finish VDI 11-13.

Ordering Information

Part Number	Package	Min. Order Qty.	Packaging Option	P0/P1	Packaging Specification
SP3130-01WTG	0201 Flipchip	10000	Tape & Reel – 8mm tape/7" reel	4mm/2mm	EIA RS-481
SP3130-01ETG	SOD882	10000	Tape & Reel – 8mm tape/7" reel	4mm/2mm	EIA RS-481

Package Dimensions – 0201 Flipchip

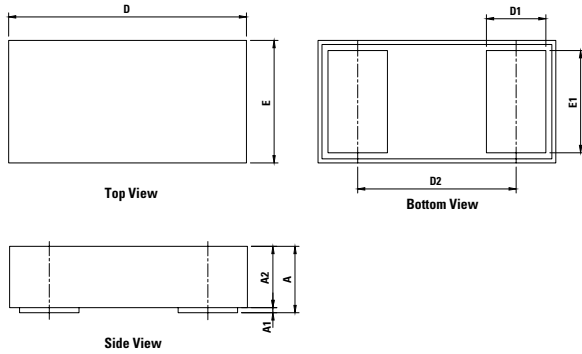

Symbol	0201 Flipchip			
	Millimeters		Inches	
	Min	Max	Min	Max
D	0.605	0.655	0.0238	0.0258
E	0.305	0.355	0.0120	0.0140
D1	0.145	0.155	0.0057	0.0061
E1	0.245	0.255	0.0096	0.0100
D2	0.400 BSC		0.0157 BSC	
A	0.273	0.329	0.0107	0.0130
A2	0.265	0.315	0.0104	0.0124
A1	0.008	0.014	0.0003	0.0006

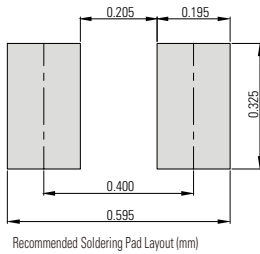

Embossed Carrier Tape & Reel Specification – 0201 Flipchip

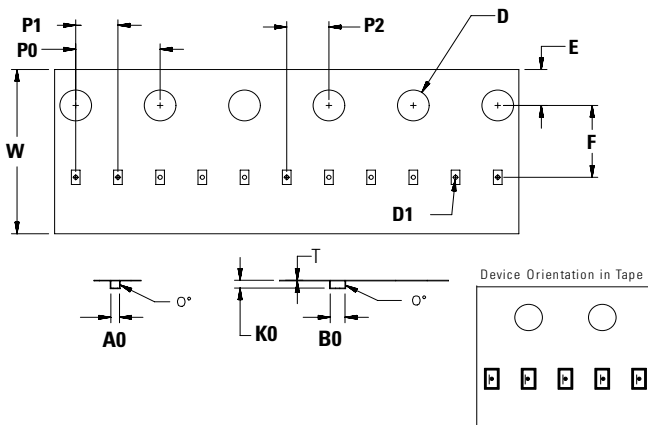

Symbol	Millimeters
A0	0.41 +/- 0.03
B0	0.70 +/- 0.03
D	∅ 1.50 + 0.10
D1	∅ 0.20 +/- 0.05
E	1.75 +/- 0.10
F	3.50 +/- 0.05
K0	0.38 +/- 0.03
P0	4.00 +/- 0.10
P1	2.00 +/- 0.05
P2	2.00 +/- 0.05
W	8.00 + 0.30 / - 0.10
T	0.23 +/- 0.02

Package Dimensions — SOD882

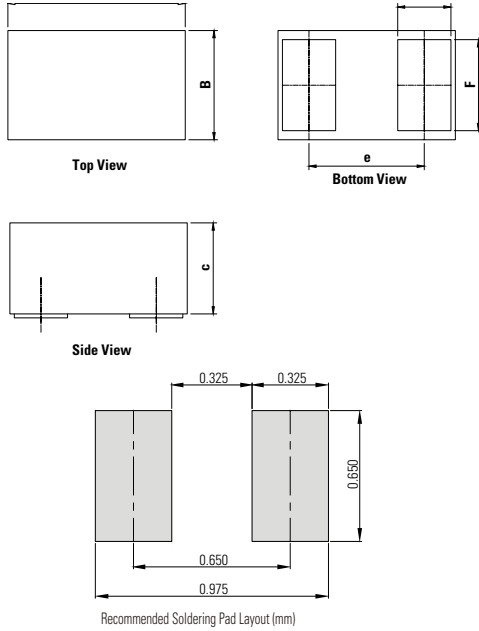

Symbol	Package	SOD882			
	JEDEC	MO-236			
	Millimeters		Inches		
	Min	Max	Min	Max	
A	0.90	1.10	0.035	0.043	
B	0.50	0.70	0.020	0.028	
C	0.40	0.60	0.016	0.024	
E	0.20	0.35	0.008	0.014	
F	0.45	0.55	0.018	0.022	
e	0.65 BSC		0.026 BSC		

Embossed Carrier Tape & Reel Specification — SOD882

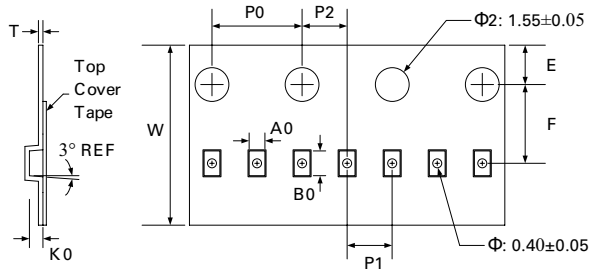

Reel Size 7 Inch

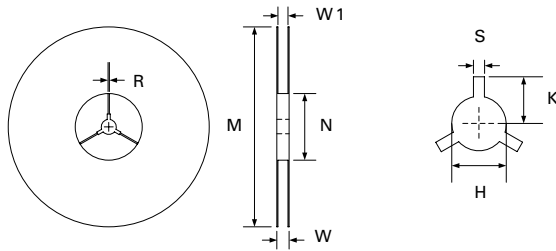

Device Orientation in Tape

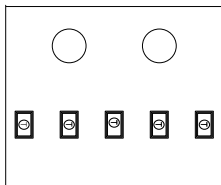

Symbol	Tape Dimensions	
	Millimetres	
	Min	Max
A0	0.65	0.75
B0	1.10	1.20
K0	0.50	0.60
E	1.65	1.85
F	3.45	3.55
P0	3.90	4.10
P1	1.90	2.10
P2	1.95	2.05
T	1.95	2.05
W	7.90	8.10

Symbol	Reel Dimensions (Size Φ178)	
	Millimetres	
	Min	Max
M	177.0	179.0
N	59.0	61.0
W	11.0	12.0
W1	8.5	9.5
H	12.5	13.5
S	1.9	2.1
K	10.8	11.2
R	0.95	1.05