

HC-A 10-ESTS

Order No.: 1773051

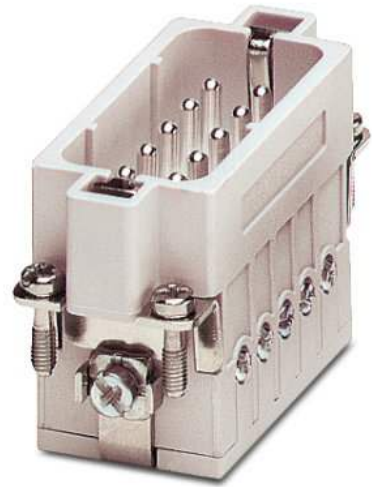

<http://eshop.phoenixcontact.de/phoenix/treeViewClick.do?UID=1773051>

HEAVYCON male insert, A10 series, 10-pos., screw connection

Commercial data

GTIN (EAN)	 4 017918 134419
sales group	D014
Pack	10 pcs.
Customs tariff	85366990
Catalog page information	Page 423 (PC-2009)

Product notes

WEEE/RoHS-compliant since:
03/01/2006



<http://www.download.phoenixcontact.com>
Please note that the data given here has been taken from the online catalog. For comprehensive information and data, please refer to the user documentation. The General Terms and Conditions of Use apply to Internet downloads.

Technical data

General data

Note	For housing HC-D15
Connection method	Screw connection
Tightening torque	0.5 Nm

Ambient temperature (operation)	-40 °C ... 125 °C (including heating up of contacts)
Pollution degree	3
Surge voltage category	III
Constructional and testing regulations	DIN VDE 0627/86
	DIN VDE 0110/02.79
	DIN VDE 0110-1/04.97
	IEC 60664-1, DIN IEC 60512
	IEC 60352
Number of positions	10
Insertion/withdrawal cycles	≥ 500
Design	A10
Connection in acc. with standard	IEC / EN
Conductor cross-section	0.5 mm ² ... 2.5 mm ²
Connection cross-section AWG	20 ... 14
Stripping length of the individual wire	7 mm
Assembly instructions	Connectors may be operated only when there is no load/voltage.

Material data

Inflammability class acc. to UL 94	V0
Contact material	Copper alloy
Contact surface material	Ag
Contact carrier material	PA

Electrical characteristics

Rated voltage (III/3)	250 V
Rated surge voltage	4 kV
Rated current	16 A

Certificates / Approvals



Certification

CSA, GOST, UL

Accessories

Item	Designation	Description
------	-------------	-------------

General

1584868	HC-A-PES	PE screw for contact inserts of A series
1772722	HC-CB	Coding pin, prevents mismatching of up to six plug connectors with an identical number of positions
1676860	HC-CBU	Keying socket for coding up to 16 plug connectors
1676857	HC-CST	Keying peg for coding up to 16 plug connectors

Diagrams/Drawings

Diagram

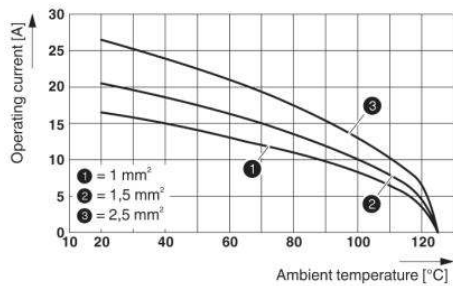

Derating diagram: Series HC-A 10...S

Dimensioned drawing

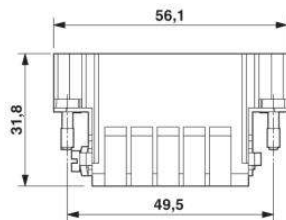

Male insert

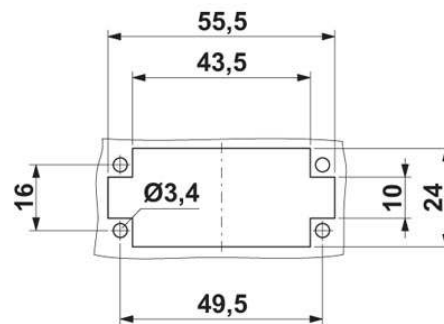
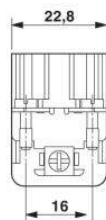

Schematic diagram

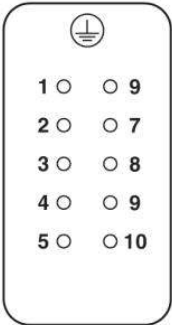
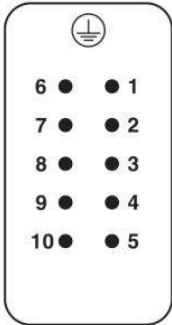

Address

PHOENIX CONTACT Inc., USA
586 Fulling Mill Road
Middletown, PA 17057, USA
Phone (800) 888-7388
Fax (717) 944-1625
<http://www.phoenixcon.com>



© 2010 Phoenix Contact
Technical modifications reserved;