

# Correspond to Analog Circuits, Ultra Low Noise 8mVp-p Small Size, Long-Life, Isolated Type DC-DC Converter

**Bellnix**® Adopted In World Important Electronic Devices.

## 1.5 Watt BY-L Series

BY-L series is a long-life, ultra low noise and isolated type DC-DC converter which is most suitable for analog circuits and analog-digital circuits. It has achieved low conducted emission and low radiated emission with the improved TCT circuit. The output noise is ultra low noise of 8mVp-p and has the ability to become the industry's minimum.

### <Features>

- Ultra Low Noise, 8mVp-p typ.
- 24pin DIP IC Size, 5-Side Metallic Shield Case
- Wide Operating Temp. Range -25°C to +71°C
- Possible to start-up from -30°C (No guarantee)
- No Electrolytic Capacitor, No Tantalum Capacitor
- MTBF 1,000,000Hrs, All aging
- High Reliability with the Latest SMD Structure
- Over-Heat Protection
- Over-Current protection
- Isolation Capacitance 100pF max.
- Isolated Type: DC500V
- Most Suitable for Analog and Digital Circuits
- High Reliability, Long-Life, High Performance
- New TCT Circuits (Patented)

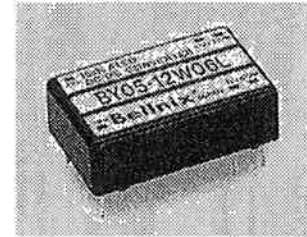

### <Model, Rating>

Table 1

Model	Rating Input Voltage Vdc	Input Voltage Range Vdc-Vdc	Output Voltage Vdc	Output I Current mA	Line Reg %(max.)	Load Reg %(max.)	Noise mVpp(typ.)	Efficiency %(typ.)
BY-L(1.5W) Series								
BY05-05S30L	5	4.75-6	5	0-300	0.3	0.3	10	60
BY05-09S16L	5	4.75-6	9	0-160	0.3	0.3	10	60
BY05-12S12L	5	4.75-6	12	0-120	0.3	0.3	10	60
BY05-15S10L	5	4.75-6	15	0-100	0.3	0.3	10	60
BY05-05W08L	5	4.75-6	±5	±0-80	0.5	0.5	8	45
BY05-12W06L	5	4.75-6	±12	±0-65	0.5	0.5	8	60
BY05-15W05L	5	4.75-6	±15	±0-53	0.5	0.5	8	60

\* This model is compatible with the old BY series to be used for substitutions.

### <Specification>

Table 2

Input Voltage/ Range	5V±0.25V (Refer to the derating curve when input is 5.25-6.0V)
Output Voltage	Refer to Table 1
Line Regulation	Refer to Table 1 (For the input voltage range of 5V±5%, at rating load)
Load Regulation	Refer to Table 1 (For the load regulation of 0-100%, at rating input voltage)
Temperature Coefficient	±0.02%/°C typ. (When operating temperature changes between -20°C to +70°C)
Short Term Drift	50mV/ 8H max. (Except initial drift)
Ripple & Noise	(1)BY-SL: 10mVp-p typ. 15mVp-p max. (2)BY-WL: 8mVp-p typ. 15mVp-p max. (20MHz bandwidth)
Efficiency	60% typ. (Rating input/ output, room temperature, refer to Table 1)
Over-Current Protection	Operates at 105% or more rating load current, auto recovery type.
Over-Voltage Protection	None
Over-Heat Protection	Built-in in the regulator part
EMI Line Filter	Built-in LC type line filter
MTBF	1,000,000Hr (EIAJ RCR-9102)
Isolation Voltage	Between primary and secondary DC500V: for 1min., between case and input/ output DC500V: for 1min.
Isolation Resistance	Between primary and secondary DC500V: 10M ohm or more, between case and input/ output DC500V: 10M ohm or more.
Isolation Capacitance	Between primary and secondary capacitance: 100pF max.
Operating Temperature Range	-25°C to +71°C (Temperature derating required from +50°C)
Storage Temperature Range	-30°C to +85°C
Humidity Range	95%R. H. max.
Cooling Condition	Natural convection
Vibration	5-10Hz All amplitude 10mm (1hour in each of 3 orthogonal axes), 10-55Hz acceleration 2G (1 hour in each of 3 orthogonal axes)
Shock	Acceleration 20G (3 times in each of 3 orthogonal axes), Shocking time 11±5ms
Weight	14g typ.
Outline	W=20.42 L=32.6 H=10.3 (mm) (For detail dimensions refer to the outline.)

\*The above specification is provided with rating value, unless otherwise specified.

### Bellnix DC-DC CONVERTERS

BDD20050408-021212

<Outline>

BY-SL Series

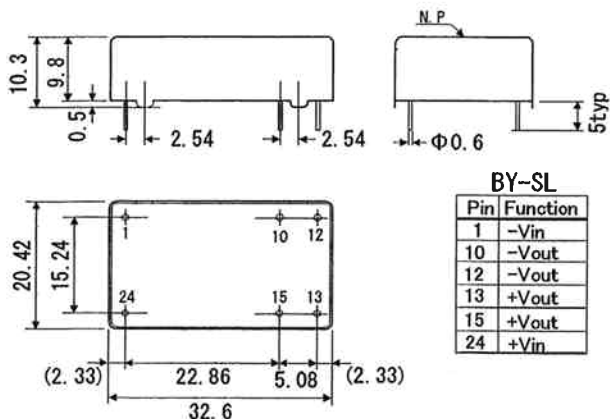

Figure 1

BY-WL Series

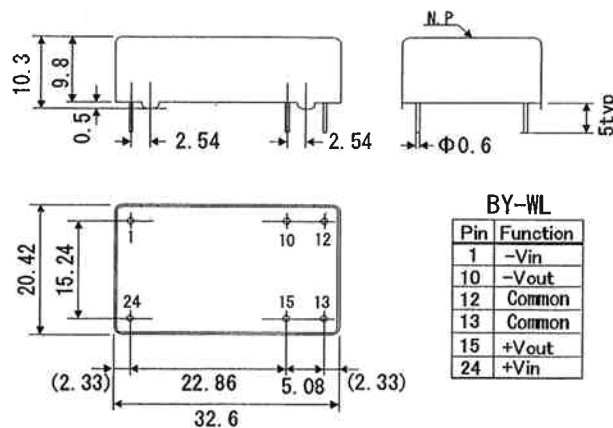

Figure 2

- Dimensions: mm, Weight: 14g typ.
- 5-Side Metallic Shield Case, black plating (with a standoff)
- Pin side is not shielded. It is recommended to set a pattern wider than the converter's bottom area right under the converter.

<Standard Usage>

BY-SL Series (5V, 9V, 12V, 15V)

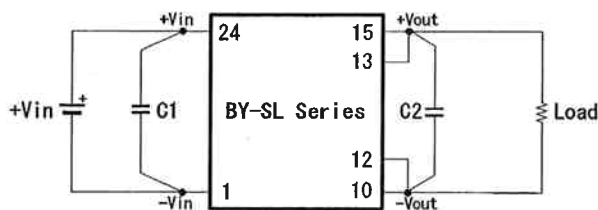

Figure 3

BY-WL Series ( $\pm 12V, \pm 15V$ )

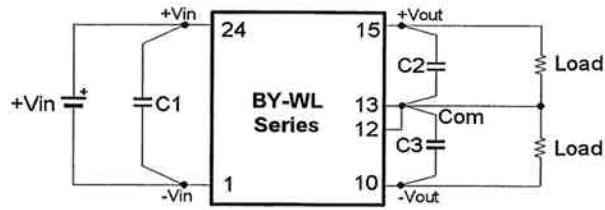

Figure 4

- Recommended capacitor  
C1=22 $\mu$ F -33 $\mu$ F (Electrolytic or multilayer ceramic capacitor)  
C2=0.47-10 $\mu$ F (Electrolytic or multilayer ceramic capacitor)

- Recommended capacitor  
C1=22 $\mu$ F -33 $\mu$ F (Electrolytic or multilayer ceramic capacitor)  
C2, C3=0.47-10 $\mu$ F (Electrolytic or multilayer ceramic capacitor)

- Basically, external capacitors are not required, but noise can be lowered by reducing power line impedance and load line impedance.
- High frequency and low impedance capacitors are recommended.
- Noise can also be lowered by designing the pattern with short lead and not to make a loop.

<Block Diagram>

BY-SL Series

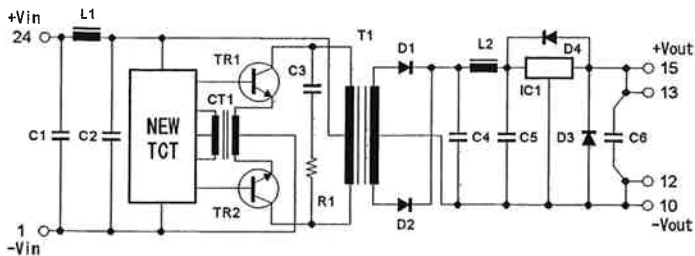

Figure 5

BY-WL Series

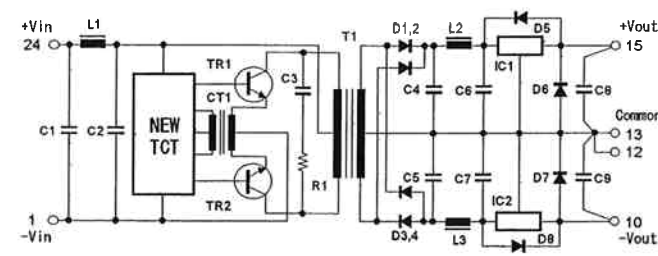

Figure 6

# Correspond to Analog Circuits, Ultra Low Noise 8mVp-p Small Size, Long-Life, Isolated Type DC-DC Converter

**Bellnix®** Adopted In World Important Electronic Devices.

## 1.5 Watt BY-L Series

### <EMI Evaluation Test>

BY-L series is most suitable for analog and digital circuit which has achieved ultra low noise.

The test data below is an EMI test data which proves that it passed the FCC Class B (3m) standards

#### RADIATED EMISSION FCC Class B <3m>

Model Name	BY05-12W06L
Serial No.	ES1
Power Supply	+5V
Load	±12V 65mA
DET. Mode	Peak
Limits	30MHz - 1000KHz
Band Number	3 Meas Mode : D
Antenna Mode	Horizontal
Test Equip.	TR4172, TR14307

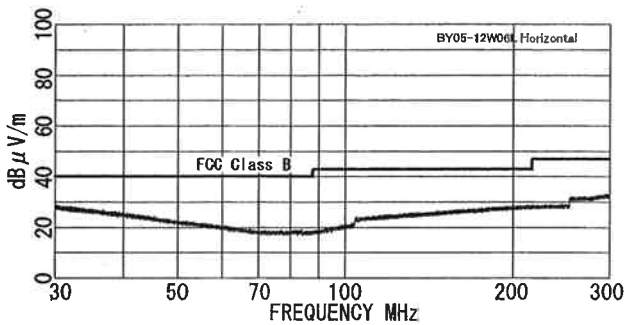

Figure 7

Model Name	BY05-12W06L
Serial No.	ES1
Power Supply	+5V
Load	±12V 65mA
DET. Mode	Peak
Limits	30MHz- 1000KHz
Band Number	3 Meas Mode : D
Antenna Mode	Vertical
Test Equip.	TR4172, TR14307

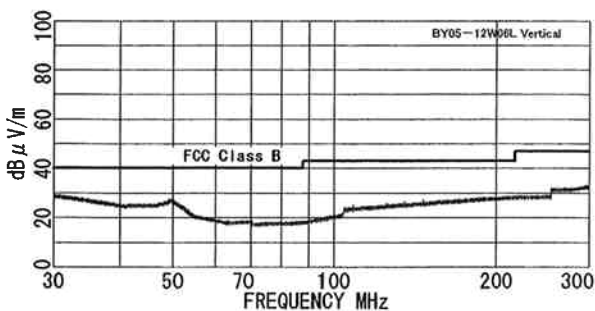

Figure 8

\* The above test has been performed at the following site.

Testing institution: Shindengen Electric Manufacturing Co., Ltd, EMI Laboratory

Field intensity measuring set: R-205

Power supply terminal interfering voltage measuring set: C-205

### <Method to decrease the noise level>

Usually for BY-L series, output capacitors are not required. However, in order to obtain lower noise level by taking advantage of the performance of the converter, make sure to design the printed board with special attention to the following items. The input/ output noise can be lowered.

1. Use low impedance capacitor with good high frequency characteristic.
2. Shorten the lead of each capacitor as much as possible, and make it low lead inductance.
3. Make the wiring loop space between the (+) and (-) of both input and output pin side as small as possible. The possibilities of leakage inductance can be decreased.
4. Design the print pattern of the main circuit as thick and short as possible.
5. The pin side of BY-L series do not have a metallic shield, so if the pin side of the printed circuit board is ground plane, the radiation noise will be shut off and noise can be lowered.

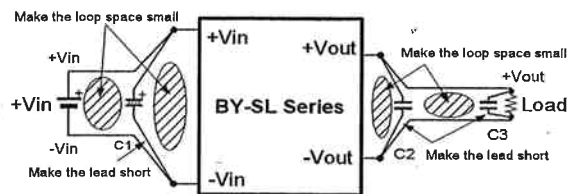

Figure 9

### Lowering the noise level of BY-SL series

C1=33μF C2=4.7μF C3=0.47μF (Electrolytic or multilayer ceramic)

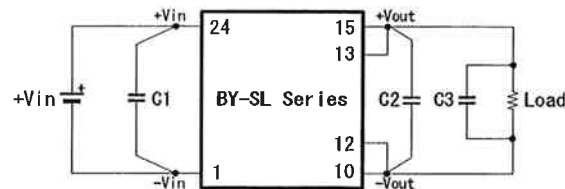

Figure 10

### Lowering the noise level of BY-WL series

C1=33μF C2, C3=4.7μF C4, C5=0.47μF (Electrolytic or multilayer ceramic)

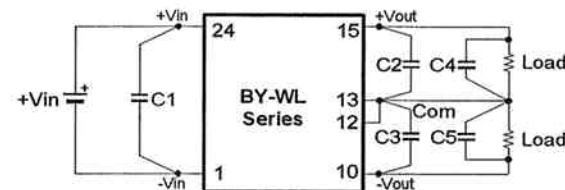

Figure 11

### Output noise of BY-05-12W06L (measured by figure 11 circuit)

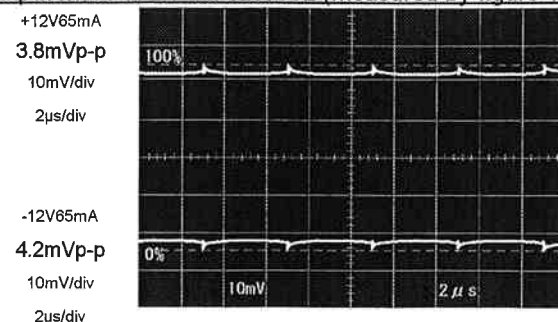

Figure 12

## Bellnix DC-DC CONVERTERS

BDD20050408-021212

### <Soldering Conditions>

Soldering is to be executed under the following conditions.

1. Soldering iron            340°C to 360° C, 2sec.
2. Soldering dip            230°C±5°C, 5 sec.

### <Cleaning Conditions>

This product can not be washed whole. When and if cleaning should be necessary, use IPA and hand-wash only the soldered surface by brush cleaning.

For further information, contact us.

### <To prevent reverse input voltage protection (ex.)>

BY-L series will be damaged if the input voltage is connected reversed. If there is a possibility of reverse connection, add a protection circuit as shown in the figure below.

The figure below is an example using the fuse and diode.

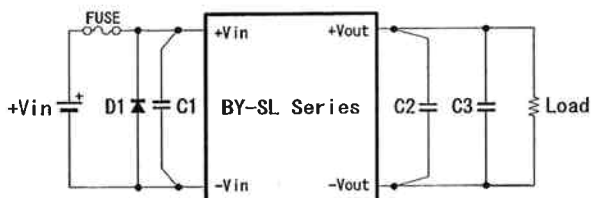

Figure 13

### <Over-Voltage Protection>

BY-L series do not have a built-in over-voltage protection.

As shown in the block diagram, BY-L series drives the transformer by the switching operation of the primary TR. So this method is of very little possibility of over-voltage to be occurred by TR damage.

However, to avoid damage at over-voltage mode, in advance, adding a circuit to intercept the supplying power circuit can be recommended.

### <Temperature Derating>

Use BY-L series within the ambient temperature in the figure below.

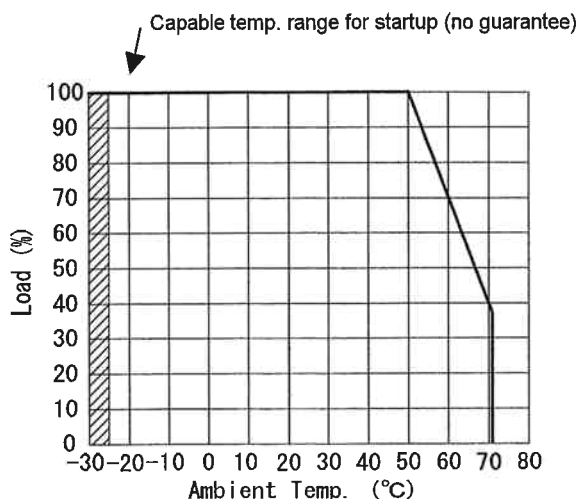

Figure 14

### <Input Voltage Derating>

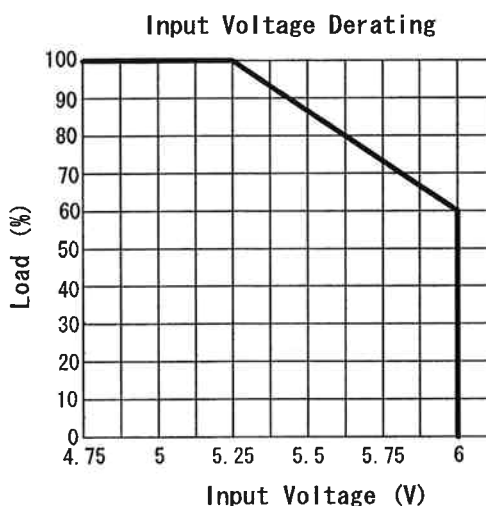

Figure 15

Correspond to Analog Circuits, Ultra Low Noise 8mVp-p  
Small Size, Long-Life, Isolated Type DC-DC Converter

**Bellnix**<sup>®</sup> Adopted In World Important Electronic Devices.

**1.5 Watt BY-L Series**

**<Precautions>**

- For this product, parallel operation is not possible.
- Series connection is possible. When connecting in series, add diode to prevent reverse bias to the output of each converter.
- This product has a built-in over-current, short protection circuit, but long time short circuit will cause failure, so avoid it.
- Be sure to execute soldering to the printed circuit board within the noted regulation temperature.
- It can not be used in case that it would affect lives or properties directly by failure of this product. Make sure to confirm us before adopting it.
- Product can not be used under oscillation, strike or temp. conditions that are out of the specification. Contact for any questions.
- No test certificate is attached to this product.

**<Guarantee>**

This product shall be guaranteed for one year. During this period, if there should be any failure definitely due to our designing or manufacturing workmanship, we will replace it with new one at our own expense.

But in case that it should be modified and/ or made internal remodeling by buyer itself whatsoever, we cannot guarantee it.

This guarantee shall cover only 1.5Watt BY-L series.

**Bellnix**<sup>®</sup>

Bellnix. Co., Ltd.

5-7-8 Negishi Minami-ku, Saitama-shi, Saitama, JAPAN 336-0024

TEL: 048-864-7733 FAX: 048-861-6402

E-mail: [info@bellnix.co.jp](mailto:info@bellnix.co.jp)

URL: <http://www.bellnix.co.jp/>

\*All specification are subjected to change without notice.

Printed in Japan BD20050408-021212



Dream and Creation