

NO. OF CKTS	DIM A	DIM B
2	.100/2.54	.200/5.08
3	.200/5.08	.300/7.62
4	.300/7.62	.400/10.16
5	.400/10.16	.500/12.70
6	.500/12.70	.600/15.24
7	.600/15.24	.700/17.78
8	.700/17.78	.800/20.32
9	.800/20.32	.900/22.86
10	.900/22.86	1.000/25.40
11	1.000/25.40	1.100/27.94
12	1.100/27.94	1.200/30.48
13	1.200/30.48	1.300/33.02
14	1.300/33.02	1.400/35.56
15	1.400/35.56	1.500/38.10
16	1.500/38.10	1.600/40.64
17	1.600/40.64	1.700/43.18
18	1.700/43.18	1.800/45.72
19	1.800/45.72	1.900/48.26
20	1.900/48.26	2.000/50.80
21	2.000/50.80	2.100/53.34
22	2.100/53.34	2.200/55.88
23	2.200/55.88	2.300/58.42
24	2.300/58.42	2.400/60.96
25	2.400/60.96	2.500/63.50
26	2.500/63.50	2.600/66.04
27	2.600/66.04	2.700/68.58
28	2.700/68.58	2.800/71.12
29	2.800/71.12	2.900/73.66
30	2.900/73.66	3.000/76.20
31	3.000/76.20	3.100/78.74
32	3.100/78.74	3.200/81.28
33	3.200/81.28	3.300/83.82
34	3.300/83.82	3.400/86.36
35	3.400/86.36	3.500/88.90
36	3.500/88.90	3.600/91.44

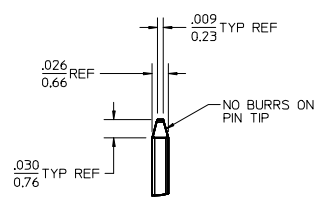

DETAIL X  
SCALE 5:1  
SEE NOTE 10

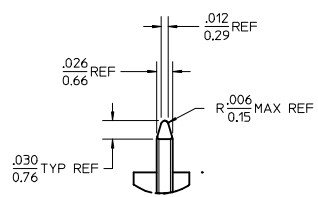

DETAIL Y  
SCALE 5:1  
SEE NOTE 10

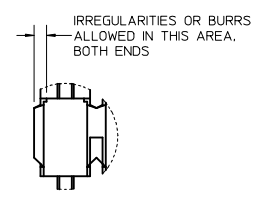

DETAIL Z  
SCALE 5:1

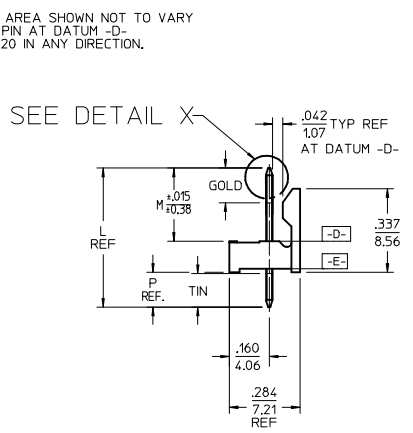
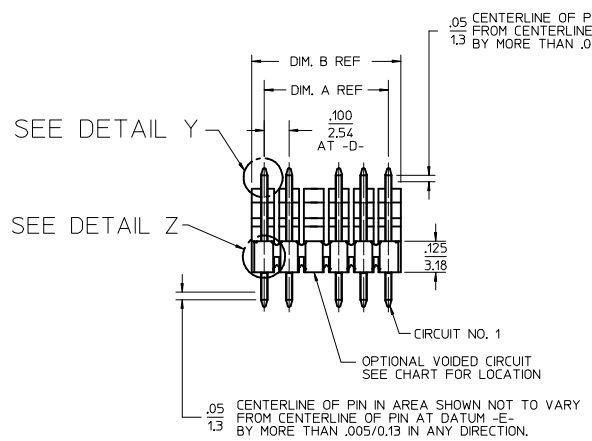
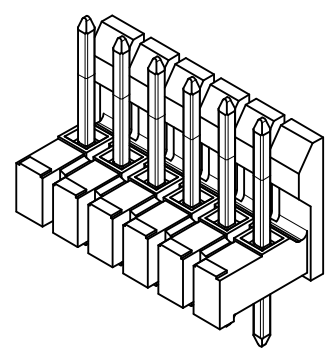

- NOTES:
- MATERIAL: NYLON, 94V-0, COLOR: BLACK
  - FINISH:
    - (154) OVERALL TIN: .000100/0.00254 MIN. OVER NICKEL: .000050/0.00127 MIN.
    - (208) SELECT GOLD: .000015/0.00038 MIN. SELECT TIN: .000100/0.00254 MIN. WITH OVERALL NICKEL UNDERPLATE: .000050/0.00127 MIN.
    - (228) SELECT GOLD: .000030/0.00076 MIN. SELECT TIN: .000100/0.00254 MIN. WITH OVERALL NICKEL UNDERPLATE: .000050/0.00127 MIN.
  - PRODUCT SPECIFICATION PS 10-07.
  - PACKAGING INFORMATION: SEE TABLES
  - SOLDERABILITY PER SMES-152.
  - PIN PUSH OUT FORCE: 3 LBS. MIN
  - KINK PIN OPTION NOT RECOMMENDED FOR 2 CIRCUIT PARTS. HOLE SIZE MAY NEED TO BE ADJUSTED ON 2 CIRCUIT PARTS WITH KINK OPTION FOR PROPER INSERTION INTO THE PCB. SEE SMES-42003 FOR ADDITIONAL INFORMATION ON KINK PIN DIRECTION AND PLACEMENT.
  - HEADERS ARE NOT STACKABLE ON .100/2.54 CENTERS.
  - PARTS CONFORM TO CLASS 'B' REQUIREMENTS OF COSMETIC SPECIFICATION PS-45499-002.
  - PIN TIP DIMENSIONS ARE SHOWN FOR REFERENCE ONLY. DIMENSIONS APPLY PRIOR TO PLATING OR ASSEMBLY.
  - FIRST AND LAST CIRCUIT BACKWALLS MUST BE REMOVED WHEN MATING TO A PART WITH POLARIZING RIBS.

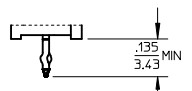

KINKED PIN OPTION  
SEE NOTE 7

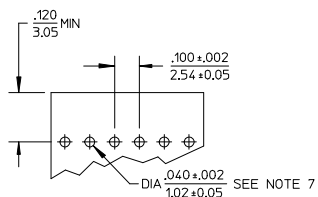

RECOMMENDED PC BOARD LAYOUT

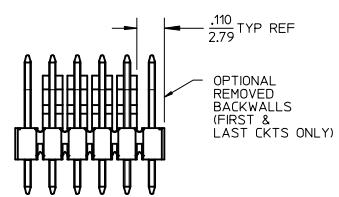

REMOVED BACKWALLS OPTION  
SEE NOTE 11

<b>ADD NOTE 11</b> EC NO: UCP2014-1471 DRW:HKIPPER 2013/10/01 CHKD:ANDERSON 2013/10/01 APPR:FSMITH 2013/10/09	QUALITY SYMBOLS ▽=0 ▽=0 ▽=0	GENERAL TOLERANCES (UNLESS SPECIFIED)		DIMENSION STYLE <b>IN/MM</b>		SCALE <b>2:1</b>	DESIGN UNITS <b>INCH</b>	THIRD ANGLE PROJECTION		
		4 PLACES	± ---	± ---	DRAWN BY	DATE	TITLE <b>.100 FRICTION LOCK BREAKAWAY HEADER ASSY</b>			
		3 PLACES	± ---	± .010	CHECKED BY	DATE				
		2 PLACES	± 0.25	± .014	MARGULIS 2004/03/18		MATERIAL NO. <b>SEE CHART</b>			
1 PLACE	± 0.36	± ---	APPROVED BY DATE		DOCUMENT NO. <b>SD-42227-002</b>		SHEET NO. <b>1 OF *</b>			
0 PLACE	±	±	ANGULAR ±1/2° DRAFT WHERE APPLICABLE MUST REMAIN WITHIN DIMENSIONS		THIS DRAWING CONTAINS INFORMATION THAT IS PROPRIETARY TO MOLEX INCORPORATED AND SHOULD NOT BE USED WITHOUT WRITTEN PERMISSION					