

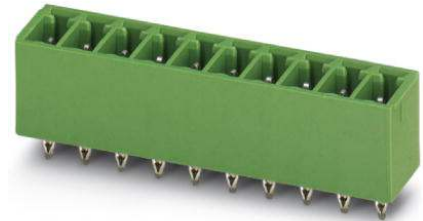

**EMCV 1,5/10-G-3,81**

Order No.: 1860728

<http://eshop.phoenixcontact.de/phoenix/treeViewClick.do?UID=1860728>

Header, Nominal current: 8 A, Rated voltage (III/2): 160 V, Number of positions: 10, Pitch: 3.81 mm, Color: green, Metal surface: Sn, Assembly: Press-in

Commercial data	
GTIN (EAN)	 4 017918 133313
sales group	E105
Pack	50 pcs.
Customs tariff	85366990
Catalog page information	Page 173 (CC-2009)

## Product notes

WEEE/RoHS-compliant since:  
01/01/2003



<http://www.download.phoenixcontact.com>  
Please note that the data given here has been taken from the online catalog. For comprehensive information and data, please refer to the user documentation. The General Terms and Conditions of Use apply to Internet downloads.

Technical data	
<b>Dimensions / positions</b>	
Length	7.25 mm
Pitch	3.81 mm
Dimension a	34.29 mm
Number of positions	10

Pin dimensions	0,8 x 0,8 mm
Hole diameter	1.45 mm

**Technical data**

Range of articles	EMCV 1,5/..-G
Insulating material group	IIIa
Rated surge voltage (III/3)	2.5 kV
Rated surge voltage (III/2)	2.5 kV
Rated surge voltage (II/2)	2.5 kV
Rated voltage (III/2)	160 V
Rated voltage (II/2)	250 V
Connection in acc. with standard	EN-VDE
Nominal current $I_N$	8 A
Nominal voltage $U_N$	160 V
Maximum load current	8 A
Insulating material	PBT
Inflammability class acc. to UL 94	V0
Nominal voltage, UL/CUL Use Group B	300 V
Nominal current, UL/CUL Use Group B	8 A
Nominal voltage, UL/CUL Use Group D	300 V
Nominal current, UL/CUL Use Group D	8 A

**Certificates / Approvals**



Certification

CUL, GOST, UL

**Accessories**

Item	Designation	Description
<b>Assembly</b>		
1877258	EMC 1,5-SH	Stamp holder, for upper and lower stamp
1877274	EMCV 1,5-SS 1	Stamp set, consisting of upper and lower stamp for 3.81 mm pitch, 2 to 16-pos.

**Marking**

0804109	SK 3,81/2,8:FORTL.ZAHLEN	Marker card, printed horizontally, self-adhesive, 10-section marker strip, 14 identical decades marked 1-10, 11-20 etc. up to 91-(99)100, sufficient for 140 terminal blocks
---------	--------------------------	--

**Plug/Adapter**

1734634	CP-MSTB	Keying profile, is inserted into the slot on the plug or inverted header, red insulating material
---------	---------	---

**Additional products**

Item	Designation	Description
<b>General</b>		
1851122	FK-MCP 1,5/10-ST-3,81	Plug component, Nominal current: 8 A, Rated voltage (III/2): 160 V, Number of positions: 10, Pitch: 3.81 mm, Color: green, Metal surface: Sn
1850741	FRONT-MC 1,5/10-ST-3,81	Plug component, Nominal current: 8 A, Rated voltage (III/2): 160 V, Number of positions: 10, Pitch: 3.81 mm, Color: green, Metal surface: Sn
1862658	IMC 1,5/10-G-3,81	Header, Nominal current: 8 A, Rated voltage (III/2): 160 V, Number of positions: 10, Pitch: 3.81 mm, Color: green, Metal surface: Sn, Assembly: Soldering
1875506	IMCV 1,5/10-G-3,81	Header, Nominal current: 8 A, Rated voltage (III/2): 160 V, Number of positions: 10, Pitch: 3.81 mm, Color: green, Metal surface: Sn, Assembly: Soldering
1803659	MC 1,5/10-ST-3,81	Plug component, Nominal current: 8 A, Rated voltage (III/2): 160 V, Number of positions: 10, Pitch: 3.81 mm, Color: green, Metal surface: Sn
1852257	MCC 1/10-STZ-3,81	Plug component, Nominal current: 8 A, Rated voltage (III/2): 160 V, Number of positions: 10, Pitch: 3.81 mm, Color: green, Metal surface: Sn, Corresponding female crimp contacts with current [A] and conductor cross section range [mm <sup>2</sup> ] data: 5A/MCC-MT 0,2-0,35 (1859988); 8A/MCC-MT 0,5-1,0 (1859991)
1827208	MCVR 1,5/10-ST-3,81	Plug component, Nominal current: 8 A, Rated voltage (III/2): 160 V, Number of positions: 10, Pitch: 3.81 mm, Color: green, Metal surface: Sn
1827059	MCVW 1,5/10-ST-3,81	Plug component, Nominal current: 8 A, Rated voltage (III/2): 160 V, Number of positions: 10, Pitch: 3.81 mm, Color: green, Metal surface: Sn
1897474	QC 0,5/10-ST-3,81	Plug component, Nominal current: 6 A, Rated voltage (III/2): 200 V, Number of positions: 10, Pitch: 3.81 mm, Color: green, Metal surface: Sn

## Diagrams/Drawings

### Drilling plan/solder pad geometry

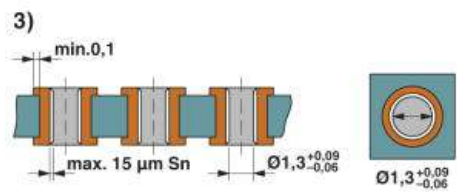
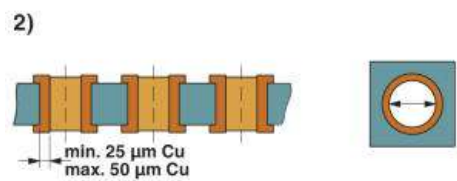
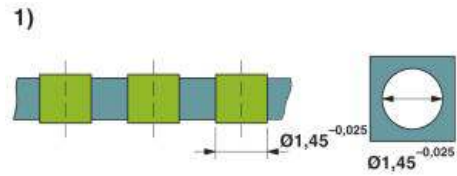
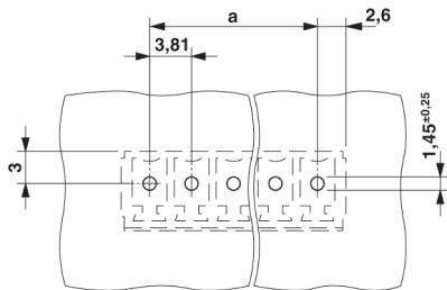

Drill hole layout in FR4 or EP-GC basic material

### Dimensioned drawing

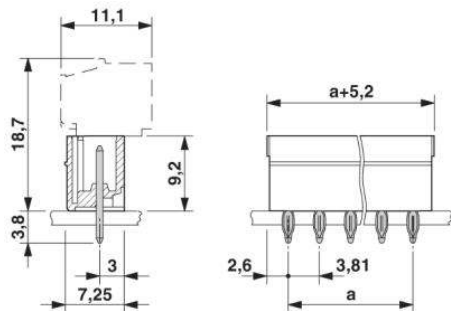

**Address**

PHOENIX CONTACT Deutschland GmbH  
Flachmarktstr. 8  
32825 Blomberg, Germany  
Phone +49 5235 3 12000  
Fax +49 5235 3 41200  
<http://www.phoenixcontact.de>



© 2010 Phoenix Contact  
Technical modifications reserved;