



DESCRIPTION

The T200 / T201 series is suitable for both mobile and industrial applications. Its small profile is ideal for space constraints. The body is machined from a single piece of 304SS to provide added protection for the internal electronics. A piezoresistive ceramic sensor along with ASIC signal conditioning provides an excellent thermally compensated output.

FEATURES

- Piezoresistive Ceramic Sensor
- ASIC Signal conditioning

APPLICATIONS

- Industrial Equipment
- Safety Monitoring
- Mobile Equipment

Specifications

Accuracy	0.5% BFSL
Pressure Range	0 to 7,500 PSI (517 BAR)
Proof Pressure	140% to 200% FS based on range (consult factory)
Burst Pressure	180% to 400% FS based on range (consult factory)
Long Term Drift	<0.3% FS @ 77°F (25°C)
Thermal Error	7.5 psi ≥ 100 psi: 0.01% FS/°F (0.018% FS/°C) 100 psi > 400 psi : 0.009% FS/°F (0.016% FS/°C) 400 psi ≥ 1000 psi: 0.011% FS/°F (0.019% FS/°C) 1000 psi > 3000 psi: 0.012% FS/°F (0.021% FS/°C) 3000 psi ≥ 7500 psi: 0.018% FS/°F (0.028% FS/°C)
Compensated Temperatures	T200 Series: 32°F to 185°F (0°C to 85°C) T201 Series: -40°F to 257°F (-40°C to 125°C)
Operating Temperatures	-40°F to 257°F (-40°C to 125°C)
Storage Temperature Rating	-40°F to 275°F (-40°C to 135°C)
Process Connection	SS304
Wetted Materials	Ceramic Al ₂ O ₃ NBR (Standard) or Optional: FKM,HNBR,EPDM
Vibration	10g (20-2000Hz) for ≤ 58 PSI (4 BAR) 20g (20 - 500Hz) for ranges > 58 PSI (4 BAR)
Shock	50g (11ms)
Supply Voltage	4 - 20mA : 8 - 30 VDC 0 - 10V : 12 - 30 VDC 0.5 - 4.5V : 4.5 - 5.5 VDC (ratiometric) 0.5 - 4.5V : 8 - 30 VDC 0 - 5V : 8 - 30 VDC 1 - 5V : 8 - 30 VDC 1 - 6V : 9 - 30 VDC 0.25 - 10.25 V : 12 - 30 VDC *Other supply voltage available upon request
Protection	Overvoltage, Short Circuit, Reverse Polarity Protection
Response Time	<1ms
Ingress Protection	IP67 (IP65 for M2 Electrical Connection)
Compliance	IEC/EN 61000-4-3(2006) 100V/m 80-1000MHz IEC/EN 61000-4-4(2004) Class 3 IEC/EN 61000-4-6(2006) 3Vrms 0.15-80MHz ROHS
Weight	0.15 lbs (0.07kg)

T200 / T201



Dimensions

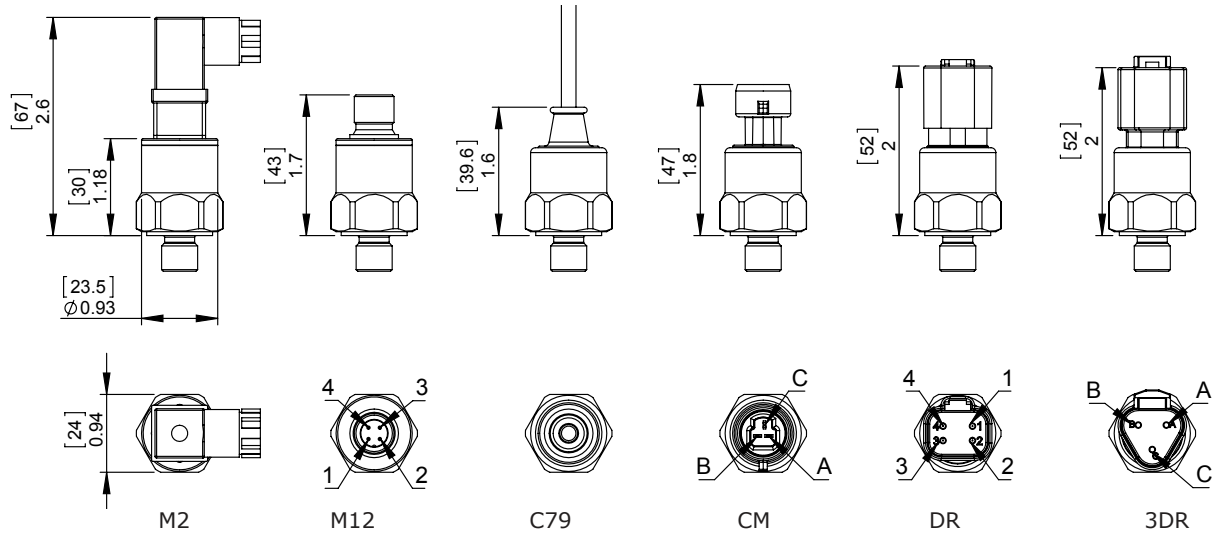

Connector	Output				
	4 - 20 mA		Voltage		
	Supply +	Supply -	Supply +	Common	Output +
M2	1	2	1	2	3
M12	1	3	1	3	4
C79 / C158	Red	Black	Red	Black	White
DR	2	1	2	1	4
3DR	A	B	A	B	C
CM	B	A	B	A	C

Ordering Information

T200 - 1 0100P - 2 G - 3 - 4 M2 - 5 4M - 6 N - 7 T1 - 8 (Optional) SR

Model:	Pressure Range:	Reference:	Output:	Electrical Connection:	Process Connection:	Seal Material:	Accuracy:	Options:
T200 Compensated Temperature Range 32°F to 185°F (0°C to 85°C)	0015P - 15 PSI 0030P - 30 PSI 0100P - 100 PSI 0150P - 150 PSI 0300P - 300 PSI 0400P - 400 PSI 0600P - 600 PSI 1000P - 1000 PSI 1500P - 1500 PSI 3000P - 3000 PSI 5000P - 5000 PSI 7500P - 7500 PSI **	A - Absolute G - Gauge S - Sealed	2 - 4 - 20 mA (2 wire) 3 - 0 - 10 V (3 wire) 4 - 0.5 - 4.5 V ratiometric 5 - 0-5 V (3 wire) 6 - 1 - 5 V (3 wire) 7 - 0.5 - 4.5 V (3 wire) 8 - 1 - 6V (3 wire) 9 - 0.25 - 10.25 V (3 wire)	M2 - DIN 43650C (Mini DIN) M12 - M12, 4 pin C79 - Shielded Cable 79 inches (2 meter) DR - Deutsch Receptacle DT04-4P DR3 - Deutsch Receptacle DT04-3P CM - Packard, Metripack, 150 Series (PS2)	2M - 1/8" NPT male 4M - 1/4" NPT male 4G - 1/4" BSPP male, G1/4 4S - 7/16-20 SAE male, with O-ring seal 6S - 9/16-18 SAE male, with O-ring seal	N - NBR (Standard) V - VITON® H - HNBR E - EPDM	T1 - 0.5% BFSL	SR - Snubber

** 7500 psi (500 BAR) is only available with 7/16 SAE thread and 9/16 SAE thread

*Other material and options available upon request.
Custom design available. Please consult factory.