



GARDTEC

Part Number:

SC80-W2

Material: C1008 Steel

Finish: Bright Nickel Chrome Plating

Ring Diameter: 1.8mm

Rib Diameter: 1.8mm

General Tolerance Unless Noted: $\pm 0.5\text{mm}$

Unit: mm

RoHS Compliant

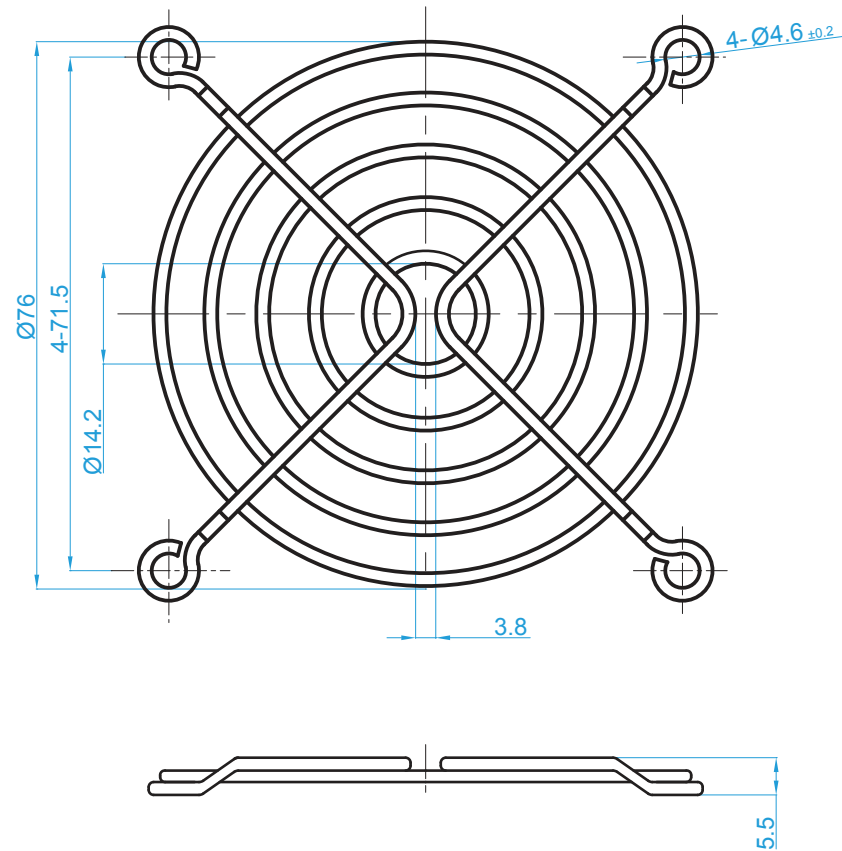

These drawings are the property of Gardtec, Inc and cannot be reproduced for or communicated to a third party without the express written permission of Gardtec, Inc.