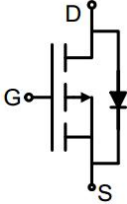
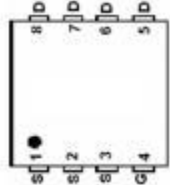
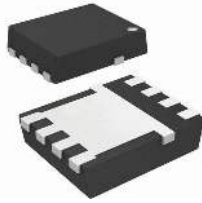

P-Channel Enhancement Mode Power MOSFET

<p>Description</p> <p>The G08P06D3 uses advanced trench technology to provide excellent $R_{DS(ON)}$, low gate charge. It can be used in a wide variety of applications.</p> <p>General Features</p> <ul style="list-style-type: none"> ● V_{DS} -60V ● I_D (at $V_{GS} = -10V$) -8A ● $R_{DS(ON)}$ (at $V_{GS} = -10V$) < 52mΩ ● 100% Avalanche Tested ● RoHS Compliant <p>Application</p> <ul style="list-style-type: none"> ● Power switch ● DC/DC converters 	 <p>Schematic diagram</p>  <p>pin assignment</p>  <p>DFN3X3-8L</p>
---	--

Ordering Information

Device	Package	Marking	Packaging
G08P06D3	DFN3X3-8L	G08P06	5000pcs/Reel

Absolute Maximum Ratings $T_C = 25^\circ\text{C}$, unless otherwise noted

Parameter	Symbol	Value	Unit
Drain-Source Voltage	V_{DS}	-60	V
Continuous Drain Current	I_D	-8	A
Pulsed Drain Current (note1)	I_{DM}	-32	A
Gate-Source Voltage	V_{GS}	± 20	V
Power Dissipation	P_D	32	W
Single pulse avalanche energy (note2)	E_{AS}	144	mJ
Operating Junction and Storage Temperature Range	T_J, T_{stg}	-55 To 150	$^\circ\text{C}$

Thermal Resistance

Parameter	Symbol	Value	Unit
Thermal Resistance, Junction-to-Ambient	R_{thJA}	22	$^\circ\text{C/W}$
Maximum Junction-to-Case	R_{thJC}	3.9	$^\circ\text{C/W}$

Specifications $T_J = 25^\circ\text{C}$, unless otherwise noted						
Parameter	Symbol	Test Conditions	Value			Unit
			Min.	Typ.	Max.	
Static Parameters						
Drain-Source Breakdown Voltage	$V_{(BR)DSS}$	$V_{GS} = 0V, I_D = -250\mu A$	-60	--	--	V
Zero Gate Voltage Drain Current	I_{DSS}	$V_{DS} = -60V, V_{GS} = 0V$	--	--	-1	μA
Gate-Source Leakage	I_{GSS}	$V_{GS} = \pm 20V$	--	--	± 100	nA
Gate-Source Threshold Voltage	$V_{GS(th)}$	$V_{DS} = V_{GS}, I_D = -250\mu A$	-2	-2.8	-3.5	V
Drain-Source On-Resistance	$R_{DS(on)}$	$V_{GS} = -10V, I_D = -6A$	--	40	52	m Ω
Forward Transconductance	g_{FS}	$V_{DS} = -5V, I_D = -6A$	--	10	--	S
Dynamic Parameters						
Input Capacitance	C_{iss}	$V_{GS} = 0V,$ $V_{DS} = -30V,$ $f = 1.0\text{MHz}$	--	2968	--	pF
Output Capacitance	C_{oss}		--	109	--	
Reverse Transfer Capacitance	C_{rss}		--	101	--	
Total Gate Charge	Q_g	$V_{DD} = -30V,$ $I_D = -6A,$ $V_{GS} = -10V$	--	25	--	nC
Gate-Source Charge	Q_{gs}		--	4	--	
Gate-Drain Charge	Q_{gd}		--	7	--	
Turn-on Delay Time	$t_{d(on)}$	$V_{DD} = -30V,$ $I_D = -6A,$ $R_G = 3\Omega$	--	58	--	ns
Turn-on Rise Time	t_r		--	15	--	
Turn-off Delay Time	$t_{d(off)}$		--	36	--	
Turn-off Fall Time	t_f		--	30	--	
Drain-Source Body Diode Characteristics						
Continuous Body Diode Current	I_S	$T_C = 25^\circ\text{C}$	--	--	-8	A
Body Diode Voltage	V_{SD}	$T_J = 25^\circ\text{C}, I_{SD} = -6A, V_{GS} = 0V$	--	--	-1.2	V
Reverse Recovery Charge	Q_{rr}	$I_F = -6A, V_{GS} = 0V$ $di/dt = -100A/\mu s$	--	19	--	nC
Reverse Recovery Time	T_{rr}		--	20	--	ns

Notes

1. Repetitive Rating: Pulse width limited by maximum junction temperature
2. EAS condition : $T_J = 25^\circ\text{C}, V_{DD} = -50V, V_{GS} = -10V, L = 0.5\text{mH}, R_G = 25\Omega$
3. Identical low side and high side switch with identical R_G

Gate Charge Test Circuit

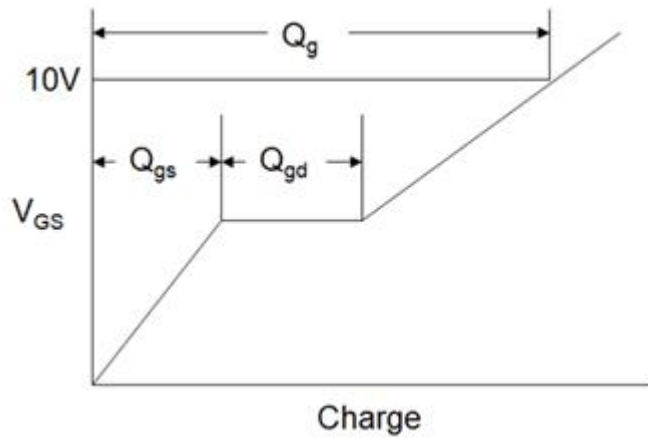

Switch Time Test Circuit

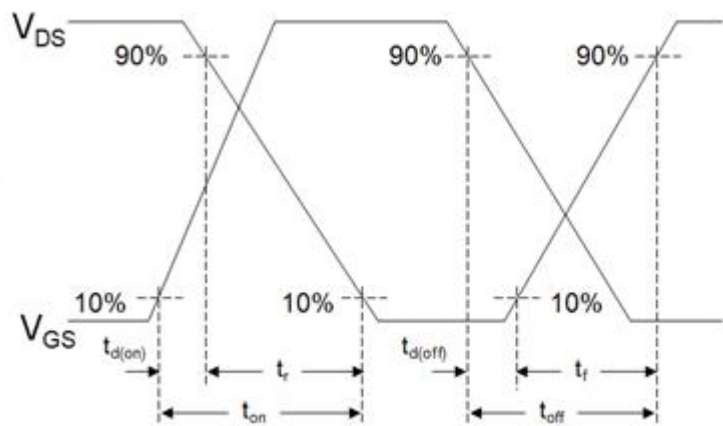

EAS Test Circuit

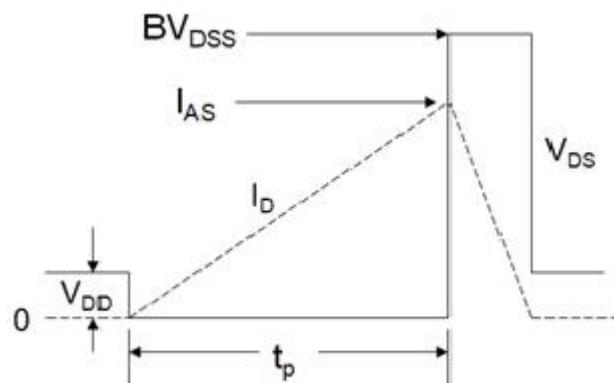
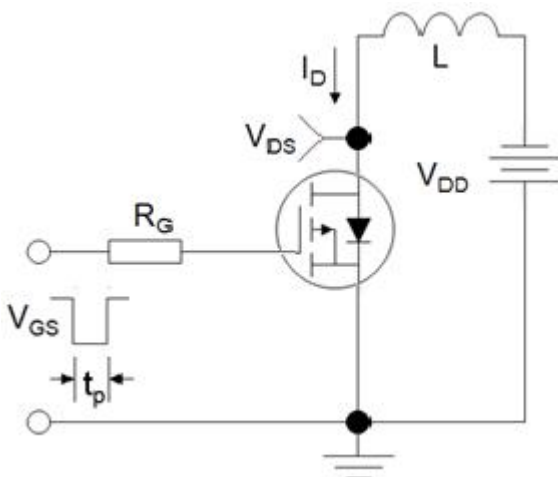

Typical Characteristics $T_J = 25^\circ\text{C}$, unless otherwise noted

Figure 1. Output Characteristics

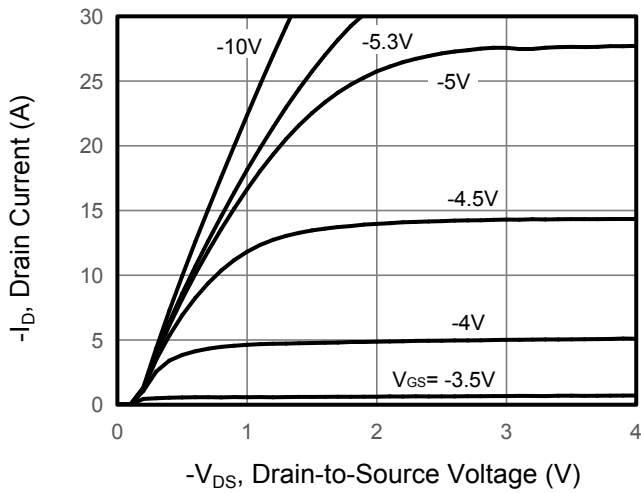

Figure 2. Transfer Characteristics

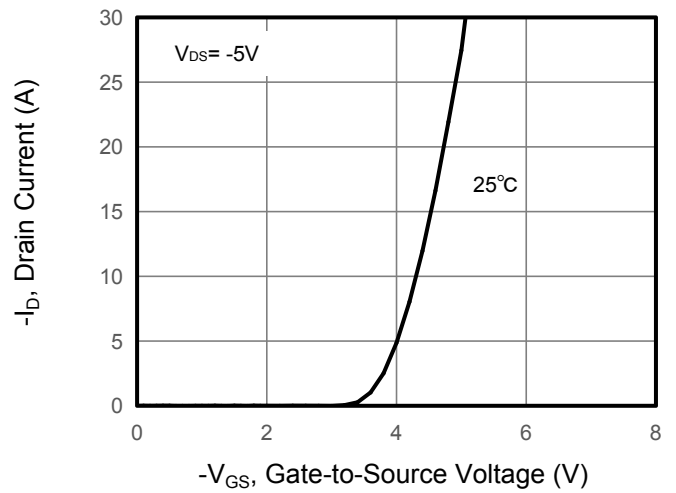

Figure 3. Drain Source On Resistance

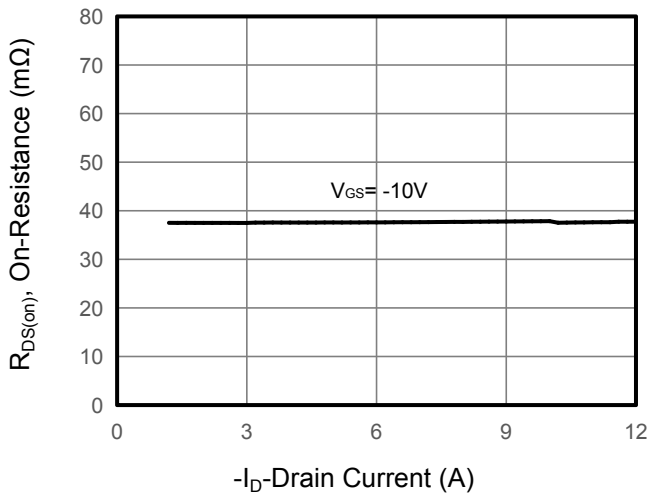

Figure 4. Gate Charge

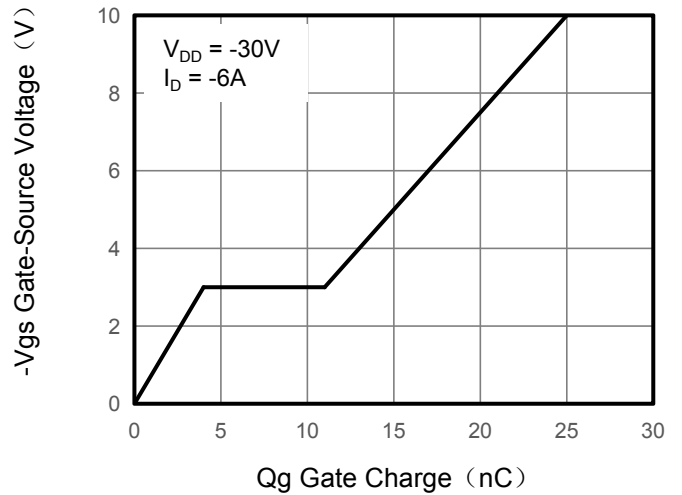

Figure 5. Capacitance

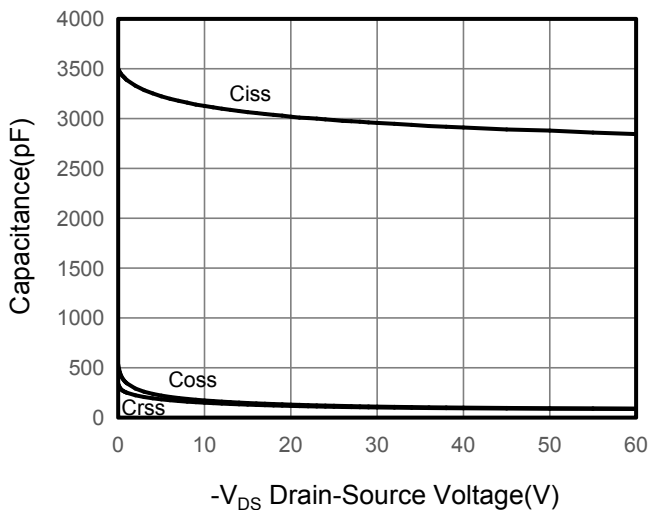
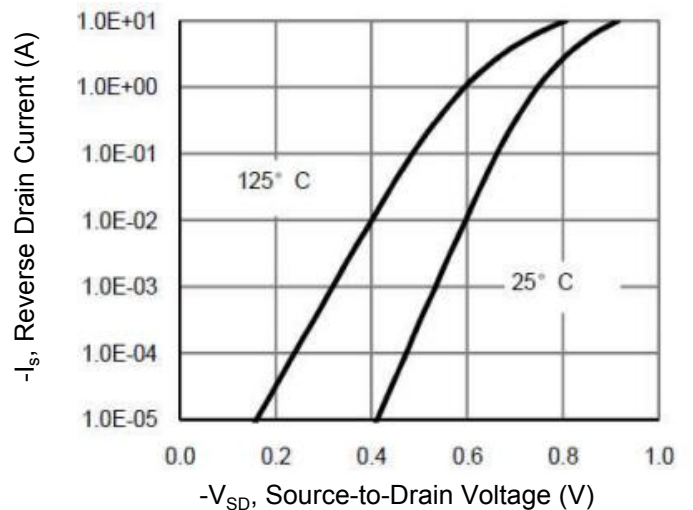

Figure 6. Source-Drain Diode Forward



Typical Characteristics $T_J = 25^\circ\text{C}$, unless otherwise noted

Figure 7. Drain-Source On-Resistance

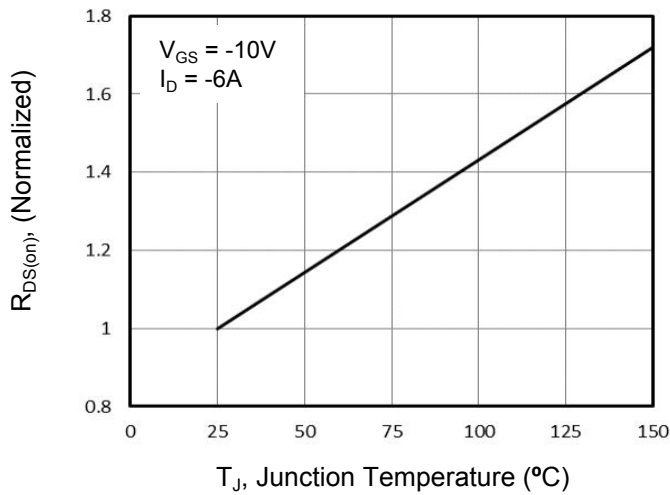

Figure 10. Safe Operation Area

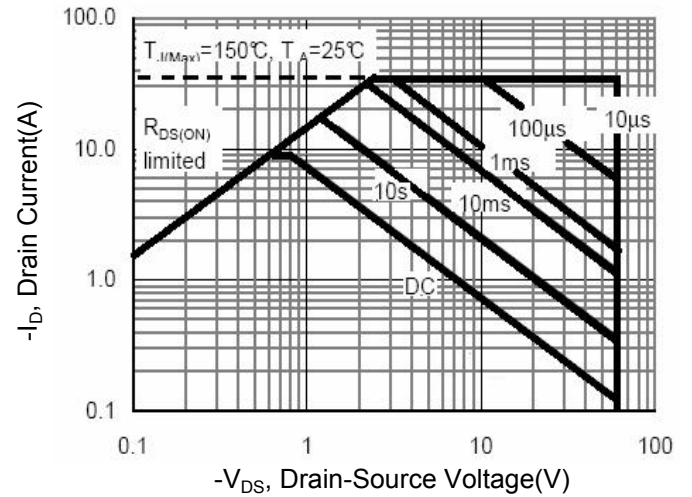
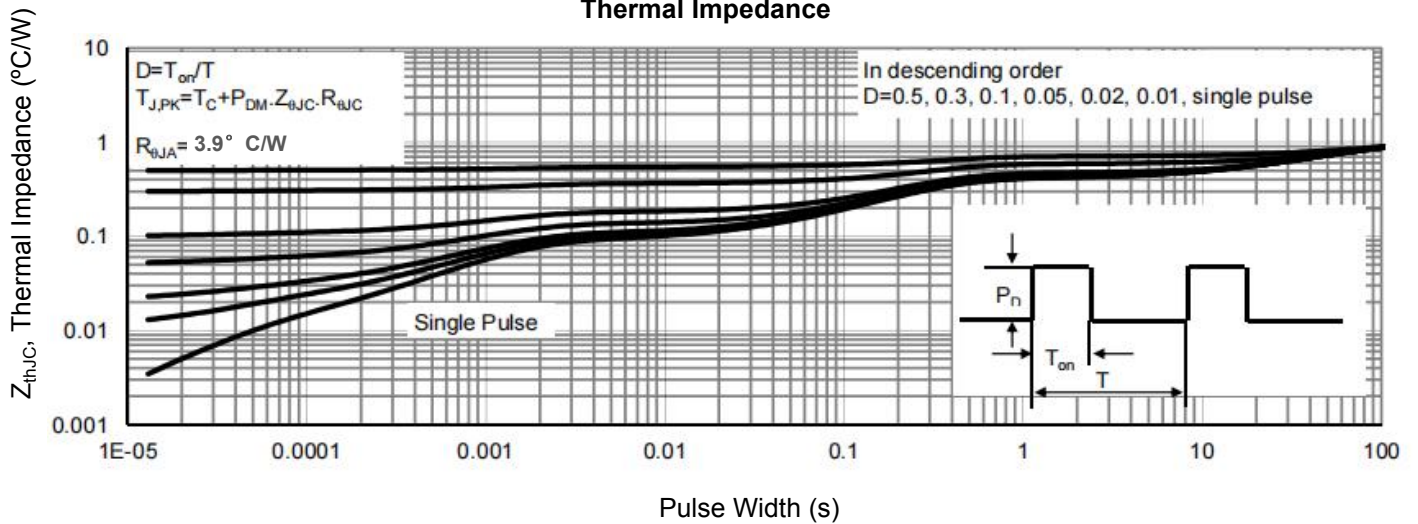
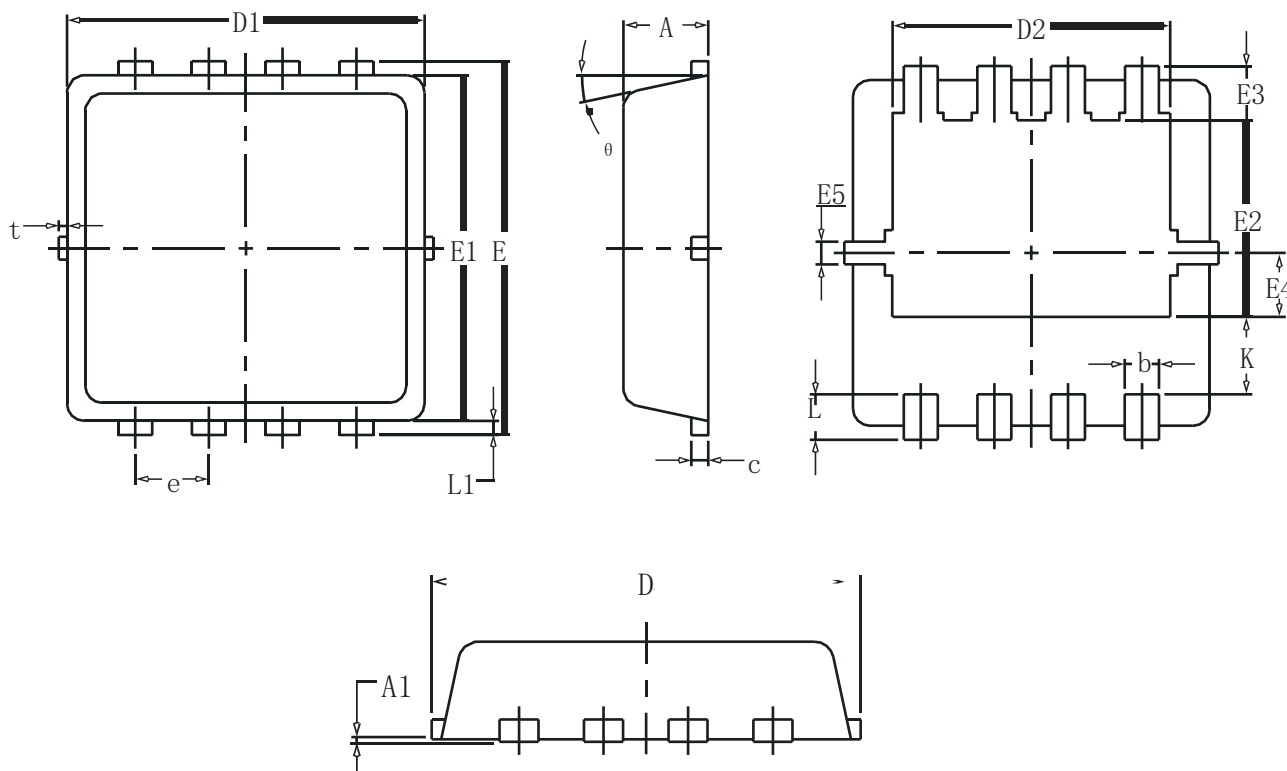

Figure 9. Normalized Maximum Transient Thermal Impedance



DFN3x3-8L Package Information



SYMBOL	COMMON		
	MM		
	MIN	NOM	MAX
A	0.70	0.75	0.85
A1	-	-	0.05
b	0.20	0.30	0.40
c	0.10	0.152	0.25
D	3.15	3.30	3.45
D1	3.00	3.15	3.25
D2	2.29	2.45	2.65
E	3.15	3.30	3.45
E1	2.90	3.05	3.20
E2	1.54	1.74	1.94
E3	0.28	0.48	0.65
E4	0.37	0.57	0.77
E5	0.10	0.20	0.30
e	0.60	0.65	0.70
K	0.59	0.69	0.89
L	0.30	0.40	0.50
L1	0.06	0.125	0.20
t	0	0.075	0.13
θ	10°	12°	14°