

Standard Gain Horn Antenna

26.5 to 40 GHz, 17 dBi

withwave

Versatile RF & MW Test Solutions

Withwave's Standard Gain Horn Antenna operates in the frequency range from 26.5 GHz to 40 GHz. This gain horn antenna have nominal gain of 17.0 dBi and Horizontal 3 dB beam width of 27.4 degrees and Vertical 3 dB beam width of 22.1 degrees. This antenna can be rotated to the desired angle by pulling and rotating it.

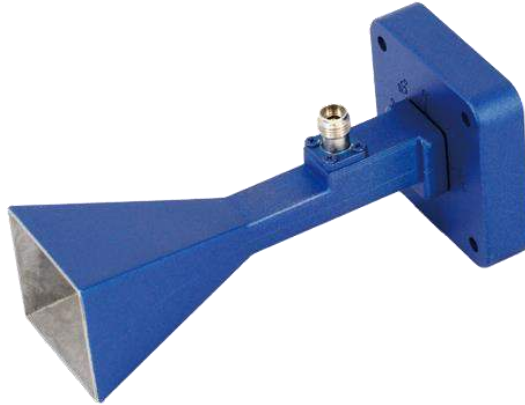

■ Features

- Rectangular Waveguide Interface
- Freq. range : 26.5 to 40 GHz
- Nominal Gain : 17 dBi

■ Configuration

- Design : Standard Gain Horn
- Pattern : Directional
- Polarization : Linear
- Coaxial interface : 2.92 mm(Female)

■ Specification

Scope	Specification	WAKH-01
Electrical	Freq. Range	26.5 to 40 GHz
	Impedance	50 Ohm
	Gain	17~19 dBi
	Horizontal 3 dB beam width	20 ± 5°
	Vertical 3 dB beam width	16 ± 5°
	Input VSWR	1.5 : 1
Mechanical	Connector type	2.92 mm(Female)
	Wave guide Size	91.4 x 40 x 40 (with bracket)
	Flange type	Square Cover
	Weight	60 g

Standard Gain Horn Antenna

26.5 to 40 GHz, 17 dBi

withwave

Versatile RF & MW Test Solutions

Gain Graph

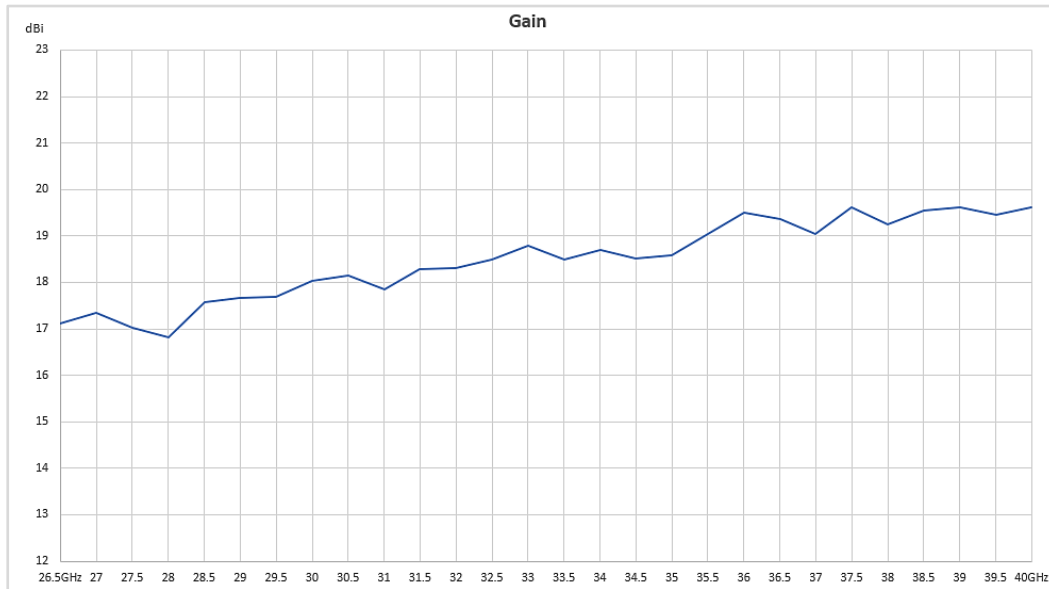

Gain Table

Frequency(GHz)	Gain (dB)
26.5	17.12
27.0	17.35
28.0	16.82
29.0	17.66
30.0	18.04
31.0	17.86
32.0	18.31
33.0	18.78
34.0	18.71
35.0	18.58
36.0	19.49
37.0	19.04
38.0	19.26
39.0	19.61
40.0	19.62

Standard Gain Horn Antenna

26.5 to 40 GHz, 17 dBi

withwave

Versatile RF & MW Test Solutions

Pattern

Horizontal Patterns

26.5 to 29 GHz

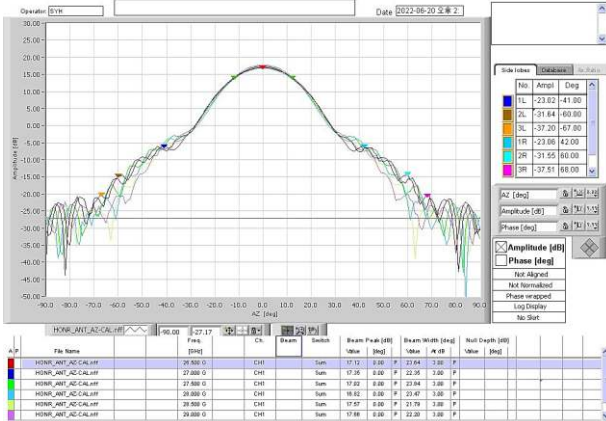

29.5 to 32 GHz

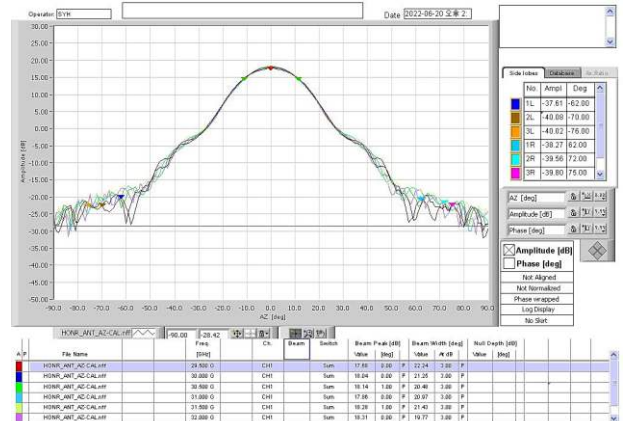

32.5 to 35 GHz

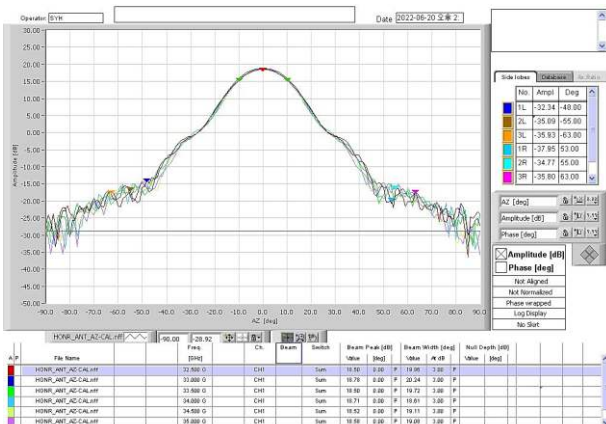

35.5 to 38 GHz

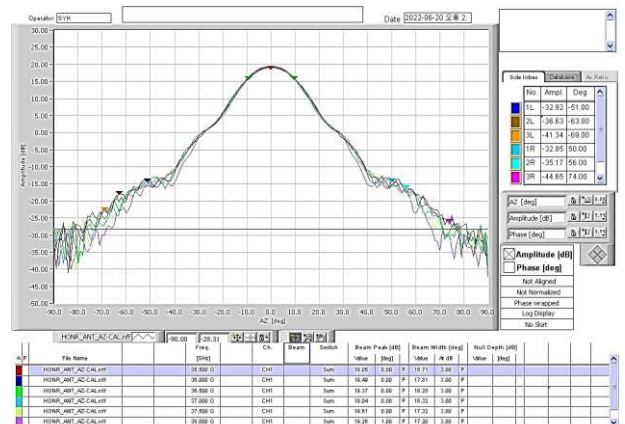

38.5 to 40 GHz

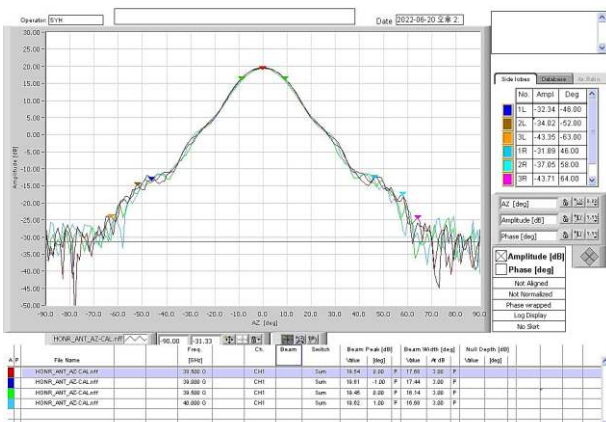

Standard Gain Horn Antenna

26.5 to 40 GHz, 17 dBi

withwave

Versatile RF & MW Test Solutions

Pattern

Vertical Patterns

26.5 to 29 GHz



29.5 to 32 GHz

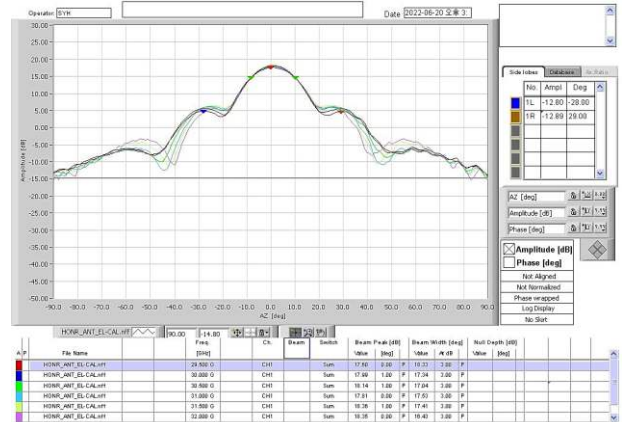

32.5 to 35 GHz

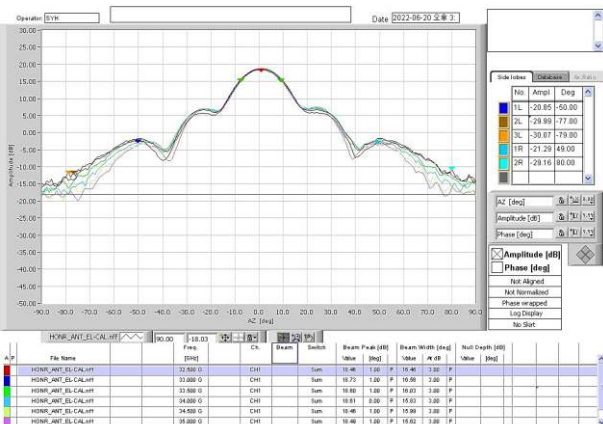

35.5 to 38 GHz

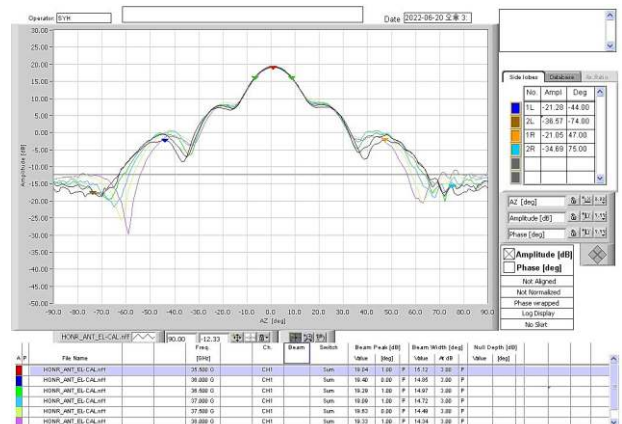

38.5 to 40 GHz



Standard Gain Horn Antenna

26.5 to 40 GHz, 17 dBi

withwave

Versatile RF & MW Test Solutions

■ VSWR

Freq. range: 26.5 to 40 GHz

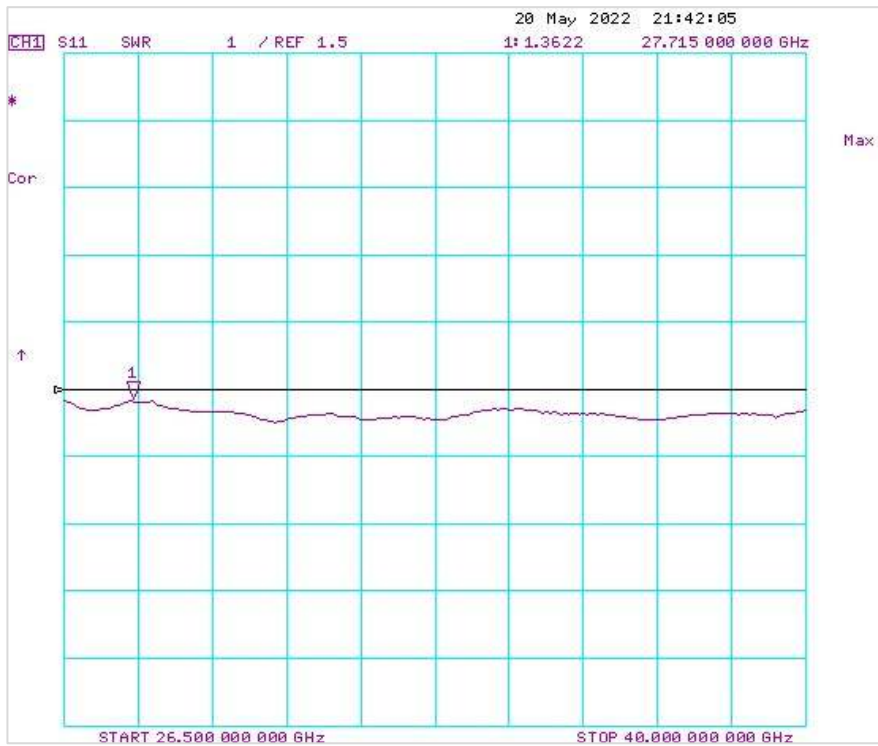

Standard Gain Horn Antenna

26.5 to 40 GHz, 17 dBi

withwave

Versatile RF & MW Test Solutions

■ Drawing

Unit : mm

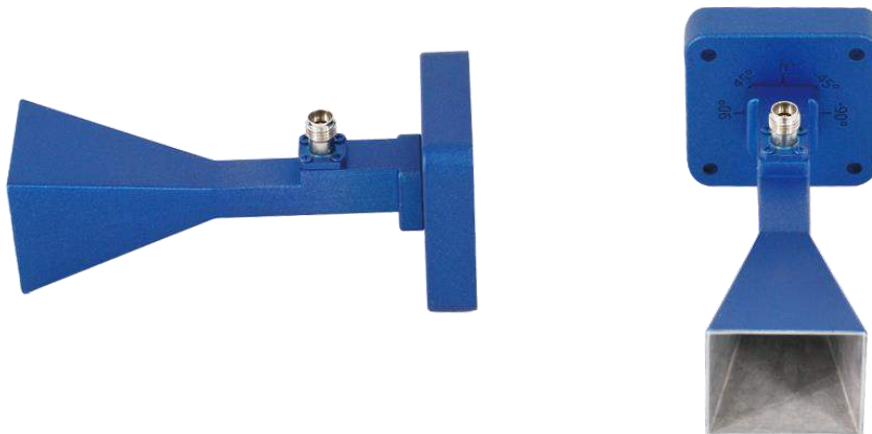
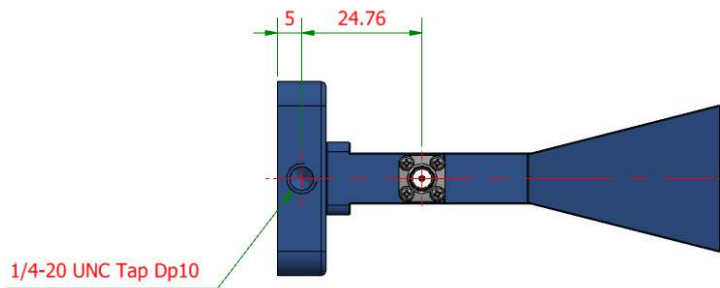
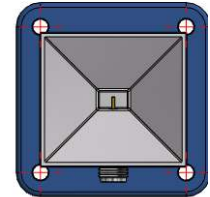
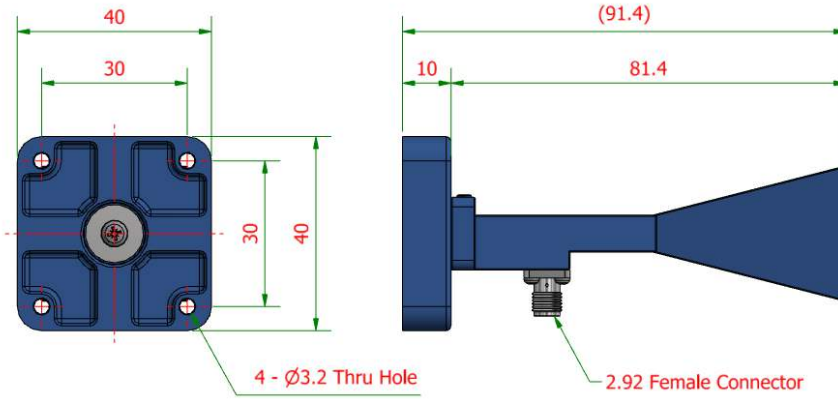

Standard Gain Horn Antenna

26.5 to 40 GHz, 17 dBi

withwave

Versatile RF & MW Test Solutions

Instrument design



*Antenna can be rotated to the desired angle by pulling and rotating it

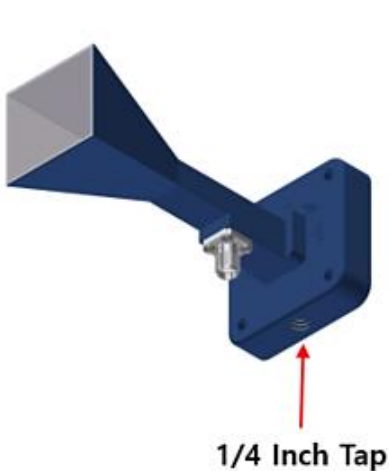
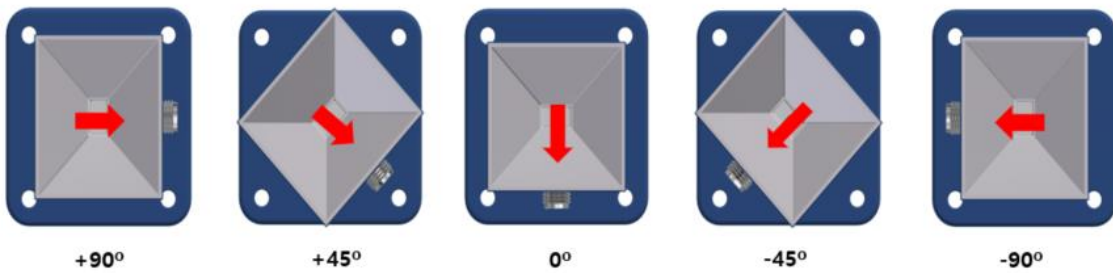

** Depending on the size of the tripod, installation may not be possible. Please check the drawing dimensions.

Standard Gain Horn Antenna

26.5 to 40 GHz, 17 dBi

withwave

Versatile RF & MW Test Solutions

■ Revision History

Revision	Date	Changes
Ver 1.0	2022-06-01	Released Standard Gain Horn Antenna