



Bridgelux® Gen 7 Vero® 18 Array

Product Data Sheet DSg2



Introduction

Vero® Series



Vero® Series is a revolutionary advancement in chip on board (COB) light source technology and innovation. Vero LED light sources simplify luminaire design and manufacturing processes. Vero Chip on Board (COB) LED arrays are available in four LES configurations, engineered to enable new degrees of flexibility and reliability over a broad range of electrical currents. Vero arrays deliver increased lumen density to enable improved beam control and precision lighting with 2 and 3 SDCM color control standard for clean and consistent uniform lighting.

Vero products include an onboard connector port that enables a solder-free electrical interconnect, and simple mounting features for plug-and-play installation.

Bridgelux Décor Series™ is our state-of-the-art color line designed specifically for premium applications, producing unmatched LED light quality with brilliant color-rendering options and pleasing lighting palettes. Bridgelux Décor Series color points are available on Vero® SE Series, Vero® Series, V Series™ and V Series™ HD.

Décor Series™ Class A is based on human response testing, providing color points with a combined GAI and CRI metric.

Décor Series™ Ultra products provide a high CRI of 97 and typical R9 value of 98, which emphasizes the reds and color tones to which the human eye is most receptive - perfect for the most luxurious retail shops and world renowned museums. Décor Series Ultra is designed as a replacement for halogen lamps.

Décor Series™ Food products offer color points developed to address the unique requirements of the food, grocery, and restaurant industries. Highlighting the distinctive colors and nuanced patterns found in meats and breads, the Décor Series Food products are a must have for any butcher counter or bakery.

Décor Series™ Entertainment products provide color points developed specifically for the healthcare and entertainment industries. The 5600K cool white color point combined with a CRI of 90 or 97 provides the bright white required by these industries.

Décor Series™ Street and Landmark is designed to be a direct replacement for high pressure sodium lamps.

Décor Series™ Showcase is the optimal solution for replacing ceramic metal halide lamps, incorporating the same pure white light with enhanced spectrum coverage and higher efficacy.

Features

- Efficacy of 170 lm/W typical for 3000K 80 CRI
- Lumen output performance ranges from 1,455 to 13,600 lumens
- Broad range of CCT options from 1750K to 6500K
- CRI options include minimum 65, 70, 80, 90, 95 and Class A
- Reliable operation at up to 2X nominal drive current
- Radial die pattern and improved lumen density
- Thermally isolated solder pads
- Onboard connector port
- Top side part number markings
- V_r bin code backside marking

Benefits

- Broad application coverage for interior and exterior lighting
- Flexibility for application driven lighting design requirements
- High quality true color reproduction
- Uniform consistent white light
- Flexibility in design optimization
- Enhanced ease of use and assembly
- Solderless connectivity enables plug & play installation and field upgradability
- Improved inventory management and quality control



Contents

Product Feature Map	2
Product Nomenclature	2
Product Selection Guide	3
Performance at Commonly Used Drive Currents	10
Electrical Characteristics	20
Eye Safety	21
Absolute Maximum Ratings	22
Performance Curves	23
Typical Radiation Pattern	27
Typical Color Spectrum	28
Mechanical Dimensions	29
Color Binning Information	30
Packaging and Labeling	31
Design Resources	33
Precautions	33
Disclaimers	33
About Bridgelux	34

Product Selection Guide

The following product configurations are available:

Table 1: Selection Guide, Pulsed Measurement Data ($T_j = T_c = 25^\circ\text{C}$)

Part Number	Nominal CCT ¹ (K)	CRI ²	Nominal Drive Current ³ (mA)	Typical Pulsed Flux ^{4,5,6} $T_c = 25^\circ\text{C}$ (lm)	Minimum Pulsed Flux ^{6,7} $T_c = 25^\circ\text{C}$ (lm)	Typical V_f (V)	Typical Power (W)	Typical Efficacy (lm/W)
BXRC-17E4000-B-74	1750	80	900	2881	2593	34.8	31.3	92
BXRC-17E4000-C-74	1750	80	1170	3624	3261	34.8	40.7	89
BXRC-17E4000-D-74	1750	80	1050	2710	2439	29.0	30.5	89
BXRC-20B4001-C-73	2000	65	1170	6392	5753	34.8	40.7	157
BXRC-20B4001-D-73	2000	65	1050	4781	4303	29.0	30.5	157
BXRC-25E4000-B-74	2500	80	900	4792	4313	34.8	31.3	153
BXRC-25E4000-C-74	2500	80	1170	6230	5607	34.8	40.7	153
BXRC-25E4000-D-74	2500	80	1050	4659	4193	29.0	30.5	153
BXRC-27E4000-B-7x	2700	80	900	5011	4510	34.8	31.3	160
BXRC-27E4000-C-7x	2700	80	1170	6515	5863	34.8	40.7	160
BXRC-27E4000-D-7x	2700	80	1050	4872	4385	29.0	30.5	160
BXRC-27G40H0-B-7x	2700	90	900	4291	3862	34.8	31.3	137
BXRC-27G40H0-C-7x	2700	90	1170	5578	5020	34.8	40.7	137
BXRC-27G40H0-D-7x	2700	90	1050	4172	3754	29.0	30.5	137
BXRC-27G4000-B-7x	2700	90	900	4134	3721	34.8	31.3	132
BXRC-27G4000-C-7x	2700	90	1170	5375	4837	34.8	40.7	132
BXRC-27G4000-D-7x	2700	90	1050	4019	3617	29.0	30.5	132
BXRC-27H4000-B-7x	2700	97	900	3664	3298	34.8	31.3	117
BXRC-27H4000-C-7x	2700	97	1170	4764	4287	34.8	40.7	117
BXRC-27H4000-D-7x	2700	97	1050	3563	3206	29.0	30.5	117
BXRC-30C4001-B-74	3000	70	900	5575	5017	34.8	31.3	178
BXRC-30C4001-C-74	3000	70	1170	7247	6523	34.8	40.7	178
BXRC-30C4001-D-74	3000	70	1050	5420	4878	29.0	30.5	178
BXRC-30E4000-B-7x	3000	80	900	5324	4792	34.8	31.3	170
BXRC-30E4000-C-7x	3000	80	1170	6922	6230	34.8	40.7	170
BXRC-30E4000-D-7x	3000	80	1050	5177	4659	29.0	30.5	170
BXRC-30G40H0-B-7x	3000	90	900	4322	3890	34.8	31.3	138
BXRC-30G40H0-C-7x	3000	90	1170	5619	5057	34.8	40.7	138
BXRC-30G40H0-D-7x	3000	90	1050	4202	3782	29.0	30.5	138
BXRC-30G4000-B-7x	3000	90	900	4510	4059	34.8	31.3	144
BXRC-30G4000-C-7x	3000	90	1170	5863	5277	34.8	40.7	144
BXRC-30G4000-D-7x	3000	90	1050	4385	3946	29.0	30.5	144
BXRC-30G400C-B-73	3000	90	900	4166	3749	34.8	31.3	133
BXRC-30G400C-D-73	3000	90	1050	4050	3645	29.0	30.5	133

Notes for Table 1:

- Nominal CCT as defined by ANSI C78.377-2011. Products with a CCT of 5000K-6500K are hot targeted to $T_c = 85^\circ\text{C}$.
- CRI values are typical for Decor Series Ultra, Decor Series Street and Landmark and Decor Series Class A products. CRI values are minimums for all other products. Minimum Rg value for 80 CRI products is 0, the minimum Rg value for 90 CRI products is 50, the minimum Rg value for 97 CRI products is 93. Bridgelux maintains a ± 3 tolerance on CRI and Rg values.
- Drive current is referred to as nominal drive current.
- Products tested under pulsed condition (10ms pulse width) at nominal test current where T_j (junction temperature) = T_c (case temperature) = 25°C .
- Typical performance values are provided as a reference only and are not a guarantee of performance.
- Bridgelux maintains a $\pm 7\%$ tolerance on flux measurements.
- Minimum flux values at the nominal test current are guaranteed by 100% test.
- Nominal CCT is defined by the Lighting Research Center's Class A definition. The center of the Class A color bin is on the corresponding isothermal line.
- GAI value is 80. To help ensure optimal fixture level performance, GAI is measured at the fixture level, on axis, at a case temperature of 70°C . GAI may vary depending on fixture design and performance.

Product Selection Guide

Table 1: Selection Guide, Pulsed Measurement Data ($T_j = T_c = 25^\circ\text{C}$) (continued)

Part Number	Nominal CCT ¹ (K)	CRI ²	Nominal Drive Current ³ (mA)	Typical Pulsed Flux ^{4,5,6} $T_c = 25^\circ\text{C}$ (lm)	Minimum Pulsed Flux ^{6,7} $T_c = 25^\circ\text{C}$ (lm)	Typical V_f (V)	Typical Power (W)	Typical Efficacy (lm/W)
BXRC-30H4000-B-7x	3000	97	900	3915	3524	34.8	31.3	125
BXRC-30H4000-C-7x	3000	97	1170	5090	4581	34.8	40.7	125
BXRC-30H4000-D-7x	3000	97	1050	3806	3426	29.0	30.5	125
BXRC-30A4001-B-73 ^{8,9}	3000	93	900	3884	3495	34.8	31.3	124
BXRC-30A4001-C-73 ^{8,9}	3000	93	1170	5049	4544	34.8	40.7	124
BXRC-30A4001-D-73 ^{8,9}	3000	93	1050	3776	3398	29.0	30.5	124
BXRC-35E4000-B-7x	3500	80	900	5450	4905	34.8	31.3	174
BXRC-35E4000-C-7x	3500	80	1170	7085	6376	34.8	40.7	174
BXRC-35E4000-D-7x	3500	80	1050	5298	4768	29.0	30.5	174
BXRC-35G4000-B-7x	3500	90	900	4479	4031	34.8	31.3	143
BXRC-35G4000-C-7x	3500	90	1170	5822	5240	34.8	40.7	143
BXRC-35G4000-D-7x	3500	90	1050	4354	3919	29.0	30.5	143
BXRC-35A4001-B-73 ^{8,9}	3500	93	900	4134	3721	34.8	31.3	132
BXRC-35A4001-C-73 ^{8,9}	3500	93	1170	5375	4837	34.8	40.7	132
BXRC-35A4001-D-73 ^{8,9}	3500	93	1050	4019	3617	29.0	30.5	132
BXRC-40C4001-B-74	4000	70	900	5732	5158	34.8	31.3	183
BXRC-40C4001-C-74	4000	70	1170	7451	6706	34.8	40.7	183
BXRC-40C4001-D-74	4000	70	1050	5572	5015	29.0	30.5	183
BXRC-40E4000-B-7x	4000	80	900	5481	4933	34.8	31.3	175
BXRC-40E4000-C-7x	4000	80	1170	7125	6413	34.8	40.7	175
BXRC-40E4000-D-7x	4000	80	1050	5329	4796	29.0	30.5	175
BXRC-40G4000-B-7x	4000	90	900	4573	4115	34.8	31.3	146
BXRC-40G4000-C-7x	4000	90	1170	5945	5350	34.8	40.7	146
BXRC-40G4000-D-7x	4000	90	1050	4446	4001	29.0	30.5	146
BXRC-40H4000-B-73	4000	97	900	4134	3721	34.8	31.3	132
BXRC-40H4000-C-73	4000	97	1170	5375	4837	34.8	40.7	132
BXRC-40H4000-D-73	4000	97	1050	4019	3617	29.0	30.5	132
BXRC-40A4001-B-73 ^{8,9}	4000	93	900	4479	4031	34.8	31.3	143
BXRC-40A4001-C-73 ^{8,9}	4000	93	1170	5822	5240	34.8	40.7	143
BXRC-40A4001-D-73 ^{8,9}	4000	93	1050	4354	3919	29.0	30.5	143
BXRC-50C4001-B-7x	5000	70	900	5763	5187	34.8	31.3	184
BXRC-50C4001-C-7x	5000	70	1170	7492	6743	34.8	40.7	184
BXRC-50C4001-D-7x	5000	70	1050	5603	5043	29.0	30.5	184
BXRC-50E4001-B-7x	5000	80	900	5544	4989	34.8	31.3	177
BXRC-50E4001-C-7x	5000	80	1170	7207	6486	34.8	40.7	177
BXRC-50E4001-D-7x	5000	80	1050	5390	4851	29.0	30.5	177

Notes for Table 1:

- Nominal CCT as defined by ANSI C78.377-2011. Products with a CCT of 5000K-6500K are hot targeted to $T_c = 85^\circ\text{C}$.
- CRI values are typical for Decor Series Ultra, Decor Series Street and Landmark and Decor Series Class A products. CRI values are minimums for all other products. Minimum R9 value for 80 CRI products is 0, the minimum R9 value for 90 CRI products is 50, the minimum R9 value for 97 CRI products is 93. Bridgelux maintains a ± 3 tolerance for all CRI and R9 values.
- Drive current is referred to as nominal drive current.
- Products tested under pulsed condition (10ms pulse width) at nominal test current where T_j (junction temperature) = T_c (case temperature) = 25°C .
- Typical performance values are provided as a reference only and are not a guarantee of performance.
- Bridgelux maintains a $\pm 7\%$ tolerance on flux measurements.
- Minimum flux values at the nominal test current are guaranteed by 100% test.
- Nominal CCT is defined by the Lighting Research Center's Class A definition. The center of the Class A color bin is on the corresponding isothermal line.
- GAI value is 80. To help ensure optimal fixture level performance, GAI is measured at the fixture level, on axis, at a case temperature of 70°C . GAI may vary depending on fixture design and performance.

Product Selection Guide

Table 1: Selection Guide, Pulsed Measurement Data ($T_j = T_c = 25^\circ\text{C}$) (continued)

Part Number	Nominal CCT ¹ (K)	CRI ²	Nominal Drive Current ³ (mA)	Typical Pulsed Flux ^{4,5,6} $T_c = 25^\circ\text{C}$ (lm)	Minimum Pulsed Flux ^{6,7} $T_c = 25^\circ\text{C}$ (lm)	Typical V_f (V)	Typical Power (W)	Typical Efficacy (lm/W)
BXRC-50G4001-B-7X	5000	90	900	4792	4313	34.8	31.3	153
BXRC-50G4001-C-7X	5000	90	1170	6230	5607	34.8	40.7	153
BXRC-50G4001-D-7X	5000	90	1050	4659	4193	29.0	30.5	153
BXRC-56G4000-B-74	5600	90	900	4823	4341	34.8	31.3	154
BXRC-56G4000-C-74	5600	90	1170	6270	5643	34.8	40.7	154
BXRC-56G400x-D-74	5600	90	1050	4689	4220	29.0	30.5	154
BXRC-56H4000-D-74	5600	97	1050	4233	3809	29.0	30.5	139
BXRC-57C4001-B-7X	5700	70	900	5606	5046	34.8	31.3	179
BXRC-57C4001-C-7X	5700	70	1170	7288	6559	34.8	40.7	179
BXRC-57C4001-D-7X	5700	70	1050	5451	4905	29.0	30.5	179
BXRC-57E4001-B-7X	5700	80	900	5324	4792	34.8	31.3	170
BXRC-57E4001-C-7X	5700	80	1170	6922	6230	34.8	40.7	170
BXRC-57E4001-D-7X	5700	80	1050	5177	4659	29.0	30.5	170
BXRC-65C4001-B-7X	6500	70	900	5606	5046	34.8	31.3	179
BXRC-65C4001-C-7X	6500	70	1170	7288	6559	34.8	40.7	179
BXRC-65C4001-D-7X	6500	70	1050	5451	4905	29.0	30.5	179
BXRC-65E4001-B-7X	6500	80	900	5387	4848	34.8	31.3	172
BXRC-65E4001-C-7X	6500	80	1170	7003	6303	34.8	40.7	172
BXRC-65E4001-D-7X	6500	80	1050	5237	4714	29.0	30.5	172

Notes for Table 1:

- Nominal CCT as defined by ANSI C78.377-2011. Products with a CCT of 5000K-6500K are hot targeted to $T_c = 85^\circ\text{C}$.
- CRI values are typical for Decor Series Ultra, Decor Series Street and Landmark and Decor Series Class A products. CRI values are minimums for all other products. Minimum R_g value for 80 CRI products is 0, the minimum R_g value for 90 CRI products is 50, the minimum R_g value for 97 CRI products is 93. Bridgelux maintains a ± 3 tolerance for all CRI and R_g values.
- Drive current is referred to as nominal drive current.
- Products tested under pulsed condition (10ms pulse width) at nominal test current where T_j (junction temperature) = T_c (case temperature) = 25°C .
- Typical performance values are provided as a reference only and are not a guarantee of performance.
- Bridgelux maintains a $\pm 7\%$ tolerance on flux measurements.
- Minimum flux values at the nominal test current are guaranteed by 100% test.
- Nominal CCT is defined by the Lighting Research Center's Class A definition. The center of the Class A color bin is on the corresponding isothermal line.
- GAI value is 80. To help ensure optimal fixture level performance, GAI is measured at the fixture level, on axis, at a case temperature of 70°C . GAI may vary depending on fixture design and performance.

Product Selection Guide

Table 2: Selection Guide, Stabilized DC Performance ($T_c = 70^\circ\text{C}$) ^{7,8}

Part Number	Nominal CCT ¹ (K)	GAI ²	CRI ³	Nominal Drive Current ⁴ (mA)	Typical DC Flux ^{5,6} $T_c = 70^\circ\text{C}$ (lm)	Minimum DC Flux ^{6,9} $T_c = 70^\circ\text{C}$ (lm)	Typical V_f (V)	Typical Power (W)	Typical Efficacy (lm/W)
BXRC-30A4001-B-73	3000	80	93	900	3612	3251	34.3	30.9	116
BXRC-30A4001-C-73	3000	80	93	1170	4695	4226	34.3	40.2	116
BXRC-30A4001-D-73	3000	80	93	1050	3511	3160	28.5	29.9	116
BXRC-35A4001-B-73	3500	80	93	900	3845	3460	34.3	30.9	123
BXRC-35A4001-C-73	3500	80	93	1170	4998	4498	34.3	40.2	123
BXRC-35A4001-D-73	3500	80	93	1050	3738	3364	28.5	29.9	123
BXRC-40A4001-B-73	4000	80	93	900	4165	3749	34.3	30.9	133
BXRC-40A4001-C-73	4000	80	93	1170	5415	4873	34.3	40.2	133
BXRC-40A4001-D-73	4000	80	93	1050	4050	3645	28.5	29.9	133

Notes for Table 2:

- Nominal CCT is defined by the Lighting Research Center's Class A definition. The center of the Class A color bin is on the corresponding isothermal line.
- To help ensure optimal fixture level performance, GAI is measured at the fixture level, on axis, at a case temperature of 70°C . GAI may vary depending on fixture design and performance.
- CRI Values are specified as typical.
- Drive current is referred to as nominal drive current.
- Typical performance values are provided as a reference only and are not a guarantee of performance.
- Bridgelux maintains a $\pm 7\%$ tolerance on flux measurements.
- Typical stabilized DC performance values are provided as reference only and are not a guarantee of performance.
- Typical performance is estimated based on operation under DC (direct current) with LED array mounted onto a heat sink with thermal interface material and the case temperature maintained at specified temperature. Based on Bridgelux test setup, values may vary depending on the thermal design of the luminaire and/or the exposed environment to which the product is subjected.
- Minimum flux values at elevated temperatures are provided for reference only and are not guaranteed by 100% production testing. Based on Bridgelux test setup, values may vary depending on the thermal design of the luminaire and/or the exposed environment to which the product is subjected.

Product Selection Guide

Table 3: Selection Guide, Stabilized DC Performance ($T_c = 85^\circ\text{C}$)^{4,5}

Part Number	Nominal CCT ¹ (K)	CRI ²	Nominal Drive Current ³ (mA)	Typical DC Flux ^{4,5} $T_c = 85^\circ\text{C}$ (lm)	Minimum DC Flux ⁶ $T_c = 85^\circ\text{C}$ (lm)	Typical V_f (V)	Typical Power (W)	Typical Efficacy (lm/W)
BXRC-17E4000-B-74	1750	80	900	2593	2334	33.9	30.5	85
BXRC-17E4000-C-74	1750	80	1170	3261	2935	33.9	39.7	82
BXRC-17E4000-D-74	1750	80	1050	2439	2195	28.1	29.5	83
BXRC-20B4001-C-73	2000	65	1170	5753	5178	33.9	39.7	145
BXRC-20B4001-D-73	2000	65	1050	4303	3872	28.1	29.5	146
BXRC-25E4000-B-74	2500	80	900	4313	3881	33.9	30.5	141
BXRC-25E4000-C-74	2500	80	1170	5607	5046	33.9	39.7	141
BXRC-25E4000-D-74	2500	80	1050	4193	3774	28.1	29.5	142
BXRC-27E4000-B-7x	2700	80	900	4510	4059	33.9	30.5	148
BXRC-27E4000-C-7x	2700	80	1170	5863	5277	33.9	39.7	148
BXRC-27E4000-D-7x	2700	80	1050	4385	3946	28.1	29.5	149
BXRC-27G40H0-B-7x	2700	90	900	3862	3476	33.9	30.5	127
BXRC-27G40H0-C-7x	2700	90	1170	5020	4518	33.9	39.7	127
BXRC-27G40H0-D-7x	2700	90	1050	3754	3379	28.1	29.5	127
BXRC-27G4000-B-7x	2700	90	900	3721	3349	33.9	30.5	122
BXRC-27G4000-C-7x	2700	90	1170	4837	4353	33.9	39.7	122
BXRC-27G4000-D-7x	2700	90	1050	3617	3256	28.1	29.5	123
BXRC-27H4000-B-7x	2700	97	900	3298	2968	33.9	30.5	108
BXRC-27H4000-C-7x	2700	97	1170	4287	3859	33.9	39.7	108
BXRC-27H4000-D-7x	2700	97	1050	3206	2886	28.1	29.5	109
BXRC-30C4001-B-74	3000	70	900	5017	4516	33.9	30.5	164
BXRC-30C4001-C-74	3000	70	1170	6523	5870	33.9	39.7	164
BXRC-30C4001-D-74	3000	70	1050	4878	4390	28.1	29.5	165
BXRC-30E4000-B-7x	3000	80	900	4792	4313	33.9	30.5	157
BXRC-30E4000-C-7x	3000	80	1170	6230	5607	33.9	39.7	157
BXRC-30E4000-D-7x	3000	80	1050	4659	4193	28.1	29.5	158
BXRC-30G40H0-B-7x	3000	90	900	3890	3501	33.9	30.5	127
BXRC-30G40H0-C-7x	3000	90	1170	5057	4551	33.9	39.7	127
BXRC-30G40H0-D-7x	3000	90	1050	3782	3404	28.1	29.5	128
BXRC-30G4000-B-7x	3000	90	900	4059	3653	33.9	30.5	133
BXRC-30G4000-C-7x	3000	90	1170	5277	4749	33.9	39.7	133
BXRC-30G4000-D-7x	3000	90	1050	3946	3552	28.1	29.5	134
BXRC-30G400C-B-73	3000	90	900	3749	3374	33.9	30.5	123
BXRC-30G400C-D-73	3000	90	1050	3645	3280	28.1	29.5	124
BXRC-30H4000-B-7x	3000	97	900	3524	3171	33.9	30.5	115

Notes for Table 3:

- Nominal CCT as defined by ANSI C78.377-2011. Products with a CCT of 5000K-6500K are hot targeted to $T_c = 85^\circ\text{C}$.
- All CRI values are measured at $T_1 = T_c = 25^\circ\text{C}$. CRI values are typical for Decor Series Ultra, Decor Series Street and Landmark and Decor Series Class A products. CRI values are minimums for all other products. Minimum Rg value for 80 CRI products is 0, the minimum Rg value for 90 CRI products is 50, the minimum Rg value for 97 CRI products is 93. Bridgelux maintains a ± 3 tolerance for all CRI and Rg values.
- Drive current is referred to as nominal drive current.
- Typical stabilized DC performance values are provided as reference only and are not a guarantee of performance.
- Typical performance is estimated based on operation under DC (direct current) with LED array mounted onto a heat sink with thermal interface material and the case temperature maintained at 85°C . Based on Bridgelux test setup, values may vary depending on the thermal design of the luminaire and/or the exposed environment to which the product is subjected.
- Minimum flux values at elevated temperatures are provided for reference only and are not guaranteed by 100% production testing. Based on Bridgelux test setup, values may vary depending on the thermal design of the luminaire and/or the exposed environment to which the product is subjected.
- Nominal CCT is defined by the Lighting Research Center's Class A definition. The center of the Class A color bin is on the corresponding isothermal line.
- GAI value is 80. To help ensure optimal fixture level performance, GAI is measured at the fixture level, on axis, at a case temperature of 70°C . GAI may vary depending on fixture design and performance.

Product Selection Guide

Table 3: Selection Guide, Stabilized DC Performance ($T_c = 85^\circ\text{C}$)^{4,5} (continued)

Part Number	Nominal CCT ¹ (K)	CRI ²	Nominal Drive Current ³ (mA)	Typical DC Flux ^{4,5} $T_c = 85^\circ\text{C}$ (lm)	Minimum DC Flux ⁶ $T_c = 85^\circ\text{C}$ (lm)	Typical V_f (V)	Typical Power (W)	Typical Efficacy (lm/W)
BXRC-30H4000-C-7x	3000	97	1170	4581	4122	33.9	39.7	115
BXRC-30H4000-D-7x	3000	97	1050	3426	3083	28.1	29.5	116
BXRC-30A4001-B-73 ^{8,9}	3000	93	900	3495	3146	33.9	30.5	115
BXRC-30A4001-C-73 ^{8,9}	3000	93	1170	4544	4090	33.9	39.7	115
BXRC-30A4001-D-73 ^{8,9}	3000	93	1050	3398	3058	28.1	29.5	115
BXRC-35E4000-B-7x	3500	80	900	4905	4414	33.9	30.5	161
BXRC-35E4000-C-7x	3500	80	1170	6376	5739	33.9	39.7	161
BXRC-35E4000-D-7x	3500	80	1050	4768	4292	28.1	29.5	162
BXRC-35G4000-B-7x	3500	90	900	4031	3628	33.9	30.5	132
BXRC-35G4000-C-7x	3500	90	1170	5240	4716	33.9	39.7	132
BXRC-35G4000-D-7x	3500	90	1050	3919	3527	28.1	29.5	133
BXRC-35A4001-B-73 ^{8,9}	3500	93	900	3721	3349	33.9	30.5	122
BXRC-35A4001-C-73 ^{8,9}	3500	93	1170	4837	4353	33.9	39.7	122
BXRC-35A4001-D-73 ^{8,9}	3500	93	1050	3617	3256	28.1	29.5	123
BXRC-40C4001-B-74	4000	70	900	5158	4643	33.9	30.5	169
BXRC-40C4001-C-74	4000	70	1170	6706	6035	33.9	39.7	169
BXRC-40C4001-D-74	4000	70	1050	5015	4514	28.1	29.5	170
BXRC-40E4000-B-7x	4000	80	900	4933	4440	33.9	30.5	162
BXRC-40E4000-C-7x	4000	80	1170	6413	5771	33.9	39.7	162
BXRC-40E4000-D-7x	4000	80	1050	4796	4316	28.1	29.5	163
BXRC-40G4000-B-7x	4000	90	900	4115	3704	33.9	30.5	135
BXRC-40G4000-C-7x	4000	90	1170	5350	4815	33.9	39.7	135
BXRC-40G4000-D-7x	4000	90	1050	4001	3601	28.1	29.5	136
BXRC-40H4000-B-7x	4000	97	900	3721	3349	33.9	30.5	122
BXRC-40H4000-C-7x	4000	97	1170	4837	4353	33.9	39.7	122
BXRC-40H4000-D-7x	4000	97	1050	3617	3256	28.1	29.5	123
BXRC-40A4001-B-73 ^{7,8}	4000	93	900	4031	3628	33.9	30.5	132
BXRC-40A4001-C-73 ^{7,8}	4000	93	1170	5240	4716	33.9	39.7	132
BXRC-40A4001-D-73 ^{7,8}	4000	93	1050	3919	3527	28.1	29.5	133
BXRC-50C4001-B-74	5000	70	900	5187	4668	33.9	30.5	170
BXRC-50C4001-C-74	5000	70	1170	6743	6068	33.9	39.7	170
BXRC-50C4001-D-74	5000	70	1050	5043	4538	28.1	29.5	171
BXRC-50E4001-B-74	5000	80	900	4989	4490	33.9	30.5	164
BXRC-50E4001-C-74	5000	80	1170	6486	5837	33.9	39.7	164
BXRC-50E4001-D-74	5000	80	1050	4851	4366	28.1	29.5	164

Notes for Table 3:

- Nominal CCT as defined by ANSI C78.377-2011. Products with a CCT of 5000K-6500K are hot targeted to $T_c = 85^\circ\text{C}$.
- All CRI values are measured at $T_c = T_a = 25^\circ\text{C}$. CRI values are typical for Decor Series Ultra, Decor Series Street and Landmark and Decor Series Class A products. CRI values are minimums for all other products. Minimum Rg value for 80 CRI products is 0, the minimum Rg value for 90 CRI products is 50, the minimum Rg value for 97 CRI products is 93. Bridgelux maintains a ± 3 tolerance for all CRI and Rg values.
- Drive current is referred to as nominal drive current.
- Typical stabilized DC performance values are provided as reference only and are not a guarantee of performance.
- Typical performance is estimated based on operation under DC (direct current) with LED array mounted onto a heat sink with thermal interface material and the case temperature maintained at 85°C . Based on Bridgelux test setup, values may vary depending on the thermal design of the luminaire and/or the exposed environment to which the product is subjected.
- Minimum flux values at elevated temperatures are provided for reference only and are not guaranteed by 100% production testing. Based on Bridgelux test setup, values may vary depending on the thermal design of the luminaire and/or the exposed environment to which the product is subjected.
- Nominal CCT is defined by the Lighting Research Center's Class A definition. The center of the Class A color bin is on the corresponding isothermal line.
- GAI value is 80. To help ensure optimal fixture level performance, GAI is measured at the fixture level, on axis, at a case temperature of 70°C . GAI may vary depending on fixture design and performance.

Product Selection Guide

Table 3: Selection Guide, Stabilized DC Performance ($T_c = 85^\circ\text{C}$)^{4,5}

Part Number	Nominal CCT ¹ (K)	CRI ²	Nominal Drive Current ³ (mA)	Typical DC Flux ^{4,5} $T_c = 85^\circ\text{C}$ (lm)	Minimum DC Flux ⁶ $T_c = 85^\circ\text{C}$ (lm)	Typical V_f (V)	Typical Power (W)	Typical Efficacy (lm/W)
BXRC-50G4001-B-7X	5000	90	900	4313	3881	33.9	30.5	141
BXRC-50G4001-C-7X	5000	90	1170	5607	5046	33.9	39.7	141
BXRC-50G4001-D-7X	5000	90	1050	4193	3774	28.1	29.5	142
BXRC-56G4000-B-74	5600	90	900	4341	3907	33.9	30.5	142
BXRC-56G4000-C-74	5600	90	1170	5643	5079	33.9	39.7	142
BXRC-56G400x-D-74	5600	90	1050	4220	3798	28.1	29.5	143
BXRC-56H4000-D-74	5600	97	1050	3809	3428	28.1	29.5	129
BXRC-57C4001-B-7X	5700	70	900	5046	4541	33.9	30.5	165
BXRC-57C4001-C-7X	5700	70	1170	6559	5903	33.9	39.7	165
BXRC-57C4001-D-7X	5700	70	1050	4905	4415	28.1	29.5	166
BXRC-57E4001-B-7X	5700	80	900	4792	4313	33.9	30.5	157
BXRC-57E4001-C-7X	5700	80	1170	6230	5607	33.9	39.7	157
BXRC-57E4001-D-7X	5700	80	1050	4659	4193	28.1	29.5	158
BXRC-65C4001-B-7X	6500	70	900	5046	4541	33.9	30.5	165
BXRC-65C4001-C-7X	6500	70	1170	6559	5903	33.9	39.7	165
BXRC-65C4001-D-7X	6500	70	1050	4905	4415	28.1	29.5	166
BXRC-65E4001-B-7X	6500	80	900	4848	4364	33.9	30.5	159
BXRC-65E4001-C-7X	6500	80	1170	6303	5673	33.9	39.7	159
BXRC-65E4001-D-7X	6500	80	1050	4714	4242	28.1	29.5	160

Notes for Table 3:

- Nominal CCT as defined by ANSI C78.377-2011. Products with a CCT of 5000K-6500K are hot targeted to $T_c = 85^\circ\text{C}$.
- All CRI values are measured at $T_1 = T_2 = 25^\circ\text{C}$. CRI values are typical for Decor Series Ultra, Decor Series Street and Landmark and Decor Series Class A products. CRI values are minimums for all other products. Minimum Rg value for 80 CRI products is 0, the minimum Rg value for 90 CRI products is 50, the minimum Rg value for 97 CRI products is 93. Bridgelux maintains a ± 3 tolerance for all CRI and Rg values.
- Drive current is referred to as nominal drive current.
- Typical stabilized DC performance values are provided as reference only and are not a guarantee of performance.
- Typical performance is estimated based on operation under DC (direct current) with LED array mounted onto a heat sink with thermal interface material and the case temperature maintained at 85°C . Based on Bridgelux test setup, values may vary depending on the thermal design of the luminaire and/or the exposed environment to which the product is subjected.
- Minimum flux values at elevated temperatures are provided for reference only and are not guaranteed by 100% production testing. Based on Bridgelux test setup, values may vary depending on the thermal design of the luminaire and/or the exposed environment to which the product is subjected.
- Nominal CCT is defined by the Lighting Research Center's Class A definition. The center of the Class A color bin is on the corresponding isothermal line.
- GAI value is 80. To help ensure optimal fixture level performance, GAI is measured at the fixture level, on axis, at a case temperature of 70°C . GAI may vary depending on fixture design and performance.

Performance at Commonly Used Drive Currents

Vero LED arrays are tested to the specifications shown using the nominal drive currents in Table 1. Vero may also be driven at other drive currents dependent on specific application design requirements. The performance at any drive current can be derived from the current vs. voltage characteristics shown in Figures 1, 2 & 3 and the flux vs. current characteristics shown in Figures 4, 5 & 6. The performance at commonly used drive currents is summarized in Table 4.

Table 4: Product Performance at Commonly Used Drive Currents

Part Number	CRI	Drive Current ¹ (mA)	Typical V _f T _c = 25°C (V)	Typical Power T _c = 25°C (W)	Typical Flux ² T _c = 25°C (lm)	Typical DC Flux ³ T _c = 85°C (lm)	Typical Efficacy T _c = 25°C (lm/W)
BXRC-17E4000-B-7x	80	450	33.2	14.9	1488	1360	100
		600	34.0	20.4	1955	1777	96
		900	34.8	31.3	2881	2593	92
		1350	35.6	48.1	4157	3662	86
		1800	36.1	65.1	5241	4504	81
BXRC-17E4000-C-7x	80	585	33.2	19.4	1872	1710	96
		780	34.0	26.5	2458	2235	93
		1170	34.8	40.7	3624	3261	89
		1755	35.6	62.5	5228	4606	84
		2340	36.1	84.6	6592	5664	78
BXRC-17E4000-D-7x	80	525	27.7	14.6	1402	1281	96
		700	28.2	19.8	1831	1665	93
		1050	29.0	30.5	2710	2439	89
		1575	30.4	47.9	4006	3529	84
		2100	31.5	66.2	5161	4434	78
BXRC-20B4001-C-73	65	585	33.2	19.4	3302	3016	170
		780	34.0	26.5	4336	3942	163
		1170	34.8	40.7	6392	5753	157
		1755	35.6	62.5	9222	8124	147
		2340	36.1	84.6	11628	9991	137
BXRC-20B4001-D-73	65	525	27.7	14.6	2474	2260	170
		700	28.2	19.8	3230	2936	163
		1050	29.0	30.5	4781	4303	157
		1575	30.4	47.9	7067	6226	147
		2100	31.5	66.2	9104	7822	137
BXRC-25E4000-B-74	80	450	33.2	14.9	2475	2261	166
		600	34.0	20.4	3250	2955	159
		900	34.8	31.3	4792	4313	153
		1350	35.6	48.1	6913	6090	144
		1800	36.1	65.1	8717	7490	134
BXRC-25E4000-C-74	80	585	33.2	19.4	3218	2940	166
		780	34.0	26.5	4226	3842	159
		1170	34.8	40.7	6230	5102	153
		1755	35.6	62.5	8987	7917	144
		2340	36.1	84.6	11332	9736	134
BXRC-25E4000-D-74	80	525	27.7	14.6	2411	2203	166
		700	28.2	19.8	3148	2862	159
		1050	29.0	30.5	4659	4193	153
		1575	30.4	47.9	6887	6067	144
		2100	31.5	66.2	8872	7623	134

Notes for Table 4:

1. Alternate drive currents are provided for reference only and are not a guarantee of performance.
2. Bridgelux maintains a ± 7% tolerance on flux measurements.
3. Typical stabilized DC performance values are provided as reference only and are not a guarantee of performance.

Performance at Commonly Used Drive Currents

Table 4: Product Performance at Commonly Used Drive Currents (Continued)

Part Number	CRI	Drive Current ¹ (mA)	Typical V _f T _c = 25°C (V)	Typical Power T _c = 25°C (W)	Typical Flux ² T _c = 25°C (lm)	Typical DC Flux ³ T _c = 85°C (lm)	Typical Efficacy T _c = 25°C (lm/W)
BXRC-27E4000-B-7x	80	450	33.2	14.9	2588	2365	173
		600	34.0	20.4	3399	3090	167
		900	34.8	31.3	5011	4510	160
		1350	35.6	48.1	7230	6369	150
		1800	36.1	65.1	9116	7832	140
BXRC-27E4000-C-7x	80	585	33.2	19.4	3365	3074	173
		780	34.0	26.5	4419	4017	167
		1170	34.8	40.7	6515	5863	160
		1755	35.6	62.5	9399	8280	150
		2340	36.1	84.6	11850	10182	140
BXRC-27E4000-D-7x	80	525	27.7	14.6	2521	2303	173
		700	28.2	19.8	3292	2993	167
		1050	29.0	30.5	4872	4385	160
		1575	30.4	47.9	7202	6345	150
		2100	31.5	66.2	9277	7971	140
BXRC-27G40H0-B-7x	90	450	33.2	14.9	2216	2025	148
		600	34.0	20.4	2911	2646	143
		900	34.8	31.3	4291	3862	137
		1350	35.6	48.1	6190	5453	129
		1800	36.1	65.1	7805	6706	120
BXRC-27G40H0-C-7x	90	585	33.2	19.4	2881	2632	148
		780	34.0	26.5	3784	3440	143
		1170	34.8	40.7	5578	5020	137
		1755	35.6	62.5	8048	7089	129
		2340	36.1	84.6	10147	8718	120
BXRC-27G40H0-D-7x	90	525	27.7	14.6	2159	1972	148
		700	28.2	19.8	2818	2562	143
		1050	29.0	30.5	4172	3754	137
		1575	30.4	47.9	6167	5433	129
		2100	31.5	66.2	7944	6825	120
BXRC-27G4000-B-7x	90	450	33.2	14.9	2135	1951	143
		600	34.0	20.4	2804	2550	137
		900	34.8	31.3	4134	3721	132
		1350	35.6	48.1	5965	5254	124
		1800	36.1	65.1	7520	6462	116
BXRC-27G4000-C-7x	90	585	33.2	19.4	2776	2536	143
		780	34.0	26.5	3646	3314	137
		1170	34.8	40.7	5375	4837	132
		1755	35.6	62.5	7754	6831	124
		2340	36.1	84.6	9776	8400	116
BXRC-27G4000-D-7x	90	525	27.7	14.6	2080	1900	143
		700	28.2	19.8	2716	2469	137
		1050	29.0	30.5	4019	3617	132
		1575	30.4	47.9	5942	5234	124
		2100	31.5	66.2	7654	6576	116

Notes for Table 4:

1. Alternate drive currents are provided for reference only and are not a guarantee of performance.
2. Bridgelux maintains a ± 7% tolerance on flux measurements.
3. Typical stabilized DC performance values are provided as reference only and are not a guarantee of performance.

Performance at Commonly Used Drive Currents

Table 4: Product Performance at Commonly Used Drive Currents (Continued)

Part Number	CRI	Drive Current ¹ (mA)	Typical V _f T _c = 25°C (V)	Typical Power T _c = 25°C (W)	Typical Flux ² T _c = 25°C (lm)	Typical DC Flux ³ T _c = 85°C (lm)	Typical Efficacy T _c = 25°C (lm/W)
BXRC-27H4000-B-7x	97	450	33.2	14.9	1893	1729	127
		600	34.0	20.4	2486	2260	122
		900	34.8	31.3	3664	3298	117
		1350	35.6	48.1	5287	4657	110
		1800	36.1	65.1	6666	5727	102
BXRC-27H4000-C-7x	97	585	33.2	19.4	2460	2248	127
		780	34.0	26.5	3231	2938	122
		1170	34.8	40.7	4764	4287	117
		1755	35.6	62.5	6873	6054	110
		2340	36.1	84.6	8665	7446	102
BXRC-27H4000-D-7x	97	525	27.7	14.6	1844	1684	127
		700	28.2	19.8	2407	2188	122
		1050	29.0	30.5	3563	3206	117
		1575	30.4	47.9	5267	4640	110
		2100	31.5	66.2	6784	5829	102
BXRC-30C4001-B-74	70	450	33.2	14.9	2879	2631	193
		600	34.0	20.4	3782	3438	185
		900	34.8	31.3	5575	5017	178
		1350	35.6	48.1	8043	7085	167
		1800	36.1	65.1	10141	8713	156
BXRC-30C4001-C-74	70	585	33.2	19.4	3743	3420	193
		780	34.0	26.5	4916	4469	185
		1170	34.8	40.7	7247	6523	178
		1755	35.6	62.5	10456	9211	167
		2340	36.1	84.6	13183	11327	156
BXRC-30C4001-D-74	70	525	27.7	14.6	2805	2563	193
		700	28.2	19.8	3662	3329	185
		1050	29.0	30.5	5420	4878	178
		1575	30.4	47.9	8013	7059	167
		2100	31.5	66.2	10321	8868	156
BXRC-30E4000-B-7x	80	450	33.2	14.9	2750	2512	184
		600	34.0	20.4	3612	3283	177
		900	34.8	31.3	5324	4792	170
		1350	35.6	48.1	7682	6767	160
		1800	36.1	65.1	9685	8322	149
BXRC-30E4000-C-7x	80	585	33.2	19.4	3575	3266	184
		780	34.0	26.5	4695	4269	177
		1170	34.8	40.7	6922	6230	170
		1755	35.6	62.5	9986	8797	160
		2340	36.1	84.6	12591	10818	149
BXRC-30E4000-D-7x	80	525	27.7	14.6	2679	2447	184
		700	28.2	19.8	3497	3180	177
		1050	29.0	30.5	5177	4659	170
		1575	30.4	47.9	7653	6741	160
		2100	31.5	66.2	9857	8470	149

Notes for Table 4:

1. Alternate drive currents are provided for reference only and are not a guarantee of performance.
2. Bridgelux maintains a ± 7% tolerance on flux measurements.
3. Typical stabilized DC performance values are provided as reference only and are not a guarantee of performance.

Performance at Commonly Used Drive Currents

Table 4: Product Performance at Commonly Used Drive Currents (Continued)

Part Number	CRI	Drive Current ¹ (mA)	Typical V _f T _c = 25°C (V)	Typical Power T _c = 25°C (W)	Typical Flux ² T _c = 25°C (lm)	Typical DC Flux ³ T _c = 85°C (lm)	Typical Efficacy T _c = 25°C (lm/W)
BXRC-30G40H0-B-7x	90	450	33.2	14.9	2232	2040	149
		600	34.0	20.4	2932	2665	144
		900	34.8	31.3	4322	3890	138
		1350	35.6	48.1	6236	5493	130
		1800	36.1	65.1	7862	6755	121
BXRC-30G40H0-C-7x	90	585	33.2	19.4	2902	2651	149
		780	34.0	26.5	3811	3465	144
		1170	34.8	40.7	5619	5057	138
		1755	35.6	62.5	8106	7141	130
		2340	36.1	84.6	10221	8782	121
BXRC-30G40H0-D-7x	90	525	27.7	14.6	2175	1987	149
		700	28.2	19.8	2839	2581	144
		1050	29.0	30.5	4202	3782	138
		1575	30.4	47.9	6212	5472	130
		2100	31.5	66.2	8002	6875	121
BXRC-30G4000-B-7x	90	450	33.2	14.9	2329	2128	156
		600	34.0	20.4	3059	2781	150
		900	34.8	31.3	4510	4059	144
		1350	35.6	48.1	6507	5732	135
		1800	36.1	65.1	8204	7049	126
BXRC-30G4000-C-7x	90	585	33.2	19.4	3028	2767	156
		780	34.0	26.5	3977	3616	150
		1170	34.8	40.7	5863	5277	144
		1755	35.6	62.5	8459	7452	135
		2340	36.1	84.6	10665	9164	126
BXRC-30G4000-D-7x	90	525	27.7	14.6	2269	2073	156
		700	28.2	19.8	2962	2693	150
		1050	29.0	30.5	4385	3946	144
		1575	30.4	47.9	6482	5710	135
		2100	31.5	66.2	8350	7174	126
BXRC-30G400C-B-73	90	450	33.2	14.9	2152	1966	144
		600	34.0	20.4	2826	2569	138
		900	34.8	31.3	4166	3749	133
		1350	35.6	48.1	6010	5294	125
		1800	36.1	65.1	7577	6511	116
BXRC-30G400C-D-73	90	525	27.7	14.6	2096	1915	144
		700	28.2	19.8	2736	2488	138
		1050	29.0	30.5	4050	3645	133
		1575	30.4	47.9	5987	5274	125
		2100	31.5	66.2	7712	6626	116
BXRC-30H4000-B-7x	97	450	33.2	14.9	2022	1847	135
		600	34.0	20.4	2656	2414	130
		900	34.8	31.3	3915	3524	125
		1350	35.6	48.1	5648	4976	117
		1800	36.1	65.1	7122	6119	109

Notes for Table 4:

1. Alternate drive currents are provided for reference only and are not a guarantee of performance.
2. Bridgelux maintains a ± 7% tolerance on flux measurements.
3. Typical stabilized DC performance values are provided as reference only and are not a guarantee of performance.

Performance at Commonly Used Drive Currents

Table 4: Product Performance at Commonly Used Drive Currents (Continued)

Part Number	CRI	Drive Current ¹ (mA)	Typical V _f T _c = 25°C (V)	Typical Power T _c = 25°C (W)	Typical Flux ² T _c = 25°C (lm)	Typical DC Flux ³ T _c = 85°C (lm)	Typical Efficacy T _c = 25°C (lm/W)
BXRC-30H4000-C-7x	97	585	33.2	19.4	2629	2402	135
		780	34.0	26.5	3452	3139	130
		1170	34.8	40.7	5090	4581	125
		1755	35.6	62.5	7343	6468	117
		2340	36.1	84.6	9258	7955	109
BXRC-30H4000-D-7x	97	525	27.7	14.6	1970	1800	135
		700	28.2	19.8	2572	2338	130
		1050	29.0	30.5	3806	3426	125
		1575	30.4	47.9	5627	4957	117
		2100	31.5	66.2	7248	6228	109
BXRC-30A4001-B-73	93	450	33.3	15.0	2006	1833	134
		600	33.9	20.4	2634	2395	129
		900	35.0	31.2	3884	3495	124
		1350	36.7	49.5	5603	4936	113
		1800	38.0	68.4	7065	6070	103
BXRC-30A4001-C-73	93	585	33.4	19.5	2608	2382	134
		780	34.0	26.5	3425	3114	129
		1170	35.0	40.6	5049	4544	124
		1755	36.8	64.5	7284	6417	113
		2340	38.1	89.3	9184	7891	103
BXRC-30A4001-D-73	93	525	27.7	14.6	1954	1785	134
		700	28.2	19.8	2551	2319	129
		1050	29.0	30.4	3776	3398	124
		1575	30.4	47.9	5582	4917	116
		2100	31.5	66.2	7190	6178	109
BXRC-35E4000-B-7x	80	450	33.2	14.9	2815	2572	188
		600	34.0	20.4	3697	3361	181
		900	34.8	31.3	5450	4905	174
		1350	35.6	48.1	7862	6926	163
		1800	36.1	65.1	9913	8518	152
BXRC-35E4000-C-7x	80	585	33.2	19.4	3659	3343	188
		780	34.0	26.5	4806	4369	181
		1170	34.8	40.7	7085	6376	174
		1755	35.6	62.5	10221	9004	163
		2340	36.1	84.6	12887	11073	152
BXRC-35E4000-D-7x	80	525	27.7	14.6	2742	2505	188
		700	28.2	19.8	3580	3254	181
		1050	29.0	30.5	5298	4768	174
		1575	30.4	47.9	7833	6900	163
		2100	31.5	66.2	10089	8669	152
BXRC-35G4000-B-7x	90	450	33.2	14.9	2313	2113	155
		600	34.0	20.4	3038	2762	149
		900	34.8	31.3	4479	4031	143
		1350	35.6	48.1	6462	5692	134
		1800	36.1	65.1	8147	7000	125

Notes for Table 4:

1. Alternate drive currents are provided for reference only and are not a guarantee of performance.
2. Bridgelux maintains a ± 7% tolerance on flux measurements.
3. Typical stabilized DC performance values are provided as reference only and are not a guarantee of performance.

Performance at Commonly Used Drive Currents

Table 4: Product Performance at Commonly Used Drive Currents (Continued)

Part Number	CRI	Drive Current ¹ (mA)	Typical V _f T _c = 25°C (V)	Typical Power T _c = 25°C (W)	Typical Flux ² T _c = 25°C (lm)	Typical DC Flux ³ T _c = 85°C (lm)	Typical Efficacy T _c = 25°C (lm/W)
BXRC-35G4000-C-7x	90	585	33.2	19.4	3007	2747	155
		780	34.0	26.5	3949	3591	149
		1170	34.8	40.7	5822	5240	143
		1755	35.6	62.5	8400	7400	134
		2340	36.1	84.6	10591	9100	125
BXRC-35G4000-D-7x	90	525	27.7	14.6	2253	2059	155
		700	28.2	19.8	2942	2675	149
		1050	29.0	30.5	4354	3919	143
		1575	30.4	47.9	6437	5671	134
		2100	31.5	66.2	8292	7124	125
BXRC-35A4001-B-73	80	450	33.2	14.9	2135	1951	143
		600	34.0	20.4	2804	2550	137
		900	34.8	31.3	4134	3721	132
		1350	35.6	48.1	5965	5254	124
		1800	36.1	65.1	7520	6462	116
BXRC-35A4001-C-73	80	585	33.2	19.4	2776	2536	143
		780	34.0	26.5	3646	3314	137
		1170	34.8	40.7	5375	4837	132
		1755	35.6	62.5	7754	6831	124
		2340	36.1	84.6	9776	8400	116
BXRC-35A4001-D-73	80	525	27.7	14.6	2080	1900	143
		700	28.2	19.8	2716	2469	137
		1050	29.0	30.5	4019	3617	132
		1575	30.4	47.9	5942	5234	124
		2100	31.5	66.2	7654	6576	116
BXRC-40C4001-B-74	80	450	33.2	14.9	2960	2705	198
		600	34.0	20.4	3888	3535	191
		900	34.8	31.3	5732	5158	183
		1350	35.6	48.1	8269	7284	172
		1800	36.1	65.1	10426	8958	160
BXRC-40C4001-C-74	80	585	33.2	19.4	3848	3516	198
		780	34.0	26.5	5054	4595	191
		1170	34.8	40.7	7451	6706	183
		1755	35.6	62.5	10750	9470	172
		2340	36.1	84.6	13554	11646	160
BXRC-40C4001-D-74	80	525	27.7	14.6	2884	2635	198
		700	28.2	19.8	3765	3423	191
		1050	29.0	30.5	5572	5015	183
		1575	30.4	47.9	8238	7257	172
		2100	31.5	66.2	10611	9117	160
BXRC-40E4000-B-7x	80	450	33.2	14.9	2831	2586	189
		600	34.0	20.4	3718	3380	182
		900	34.8	31.3	5481	4933	175
		1350	35.6	48.1	7908	6966	164
		1800	36.1	65.1	9970	8566	153

Notes for Table 4:

1. Alternate drive currents are provided for reference only and are not a guarantee of performance.
2. Bridgelux maintains a ± 7% tolerance on flux measurements.
3. Typical stabilized DC performance values are provided as reference only and are not a guarantee of performance.

Performance at Commonly Used Drive Currents

Table 4: Product Performance at Commonly Used Drive Currents (Continued)

Part Number	CRI	Drive Current ¹ (mA)	Typical V_f $T_c = 25^\circ\text{C}$ (V)	Typical Power $T_c = 25^\circ\text{C}$ (W)	Typical Flux ² $T_c = 25^\circ\text{C}$ (lm)	Typical DC Flux ³ $T_c = 85^\circ\text{C}$ (lm)	Typical Efficacy $T_c = 25^\circ\text{C}$ (lm/W)
BXRC-40E4000-C-7x	80	585	33.2	19.4	3680	3362	189
		780	34.0	26.5	4833	4394	182
		1170	34.8	40.7	7125	6413	175
		1755	35.6	62.5	10280	9056	164
		2340	36.1	84.6	12961	11136	153
BXRC-40E4000-D-7x	80	525	27.7	14.6	2758	2519	189
		700	28.2	19.8	3600	3273	182
		1050	29.0	30.5	5329	4796	175
		1575	30.4	47.9	7878	6940	164
		2100	31.5	66.2	10147	8719	153
BXRC-40G4000-B-7x	90	450	33.2	14.9	2362	2158	158
		600	34.0	20.4	3102	2820	152
		900	34.8	31.3	4573	4115	146
		1350	35.6	48.1	6597	5812	137
		1800	36.1	65.1	8318	7147	128
BXRC-40G4000-C-7x	90	585	33.2	19.4	3070	2805	158
		780	34.0	26.5	4032	3666	152
		1170	34.8	40.7	5945	5350	146
		1755	35.6	62.5	8576	7555	137
		2340	36.1	84.6	10813	9291	128
BXRC-40G4000-D-7x	90	525	27.7	14.6	2301	2102	158
		700	28.2	19.8	3004	2731	152
		1050	29.0	30.5	4446	4001	146
		1575	30.4	47.9	6572	5790	137
		2100	31.5	66.2	8466	7274	128
BXRC-40H4000-B-7x	97	450	33.2	14.9	2135	1951	143
		600	34.0	20.4	2804	2550	137
		900	34.8	31.3	4134	3721	132
		1350	35.6	48.1	5965	5254	124
		1800	36.1	65.1	7520	6462	116
BXRC-40H4000-C-7x	97	585	33.2	19.4	2776	2536	143
		780	34.0	26.5	3646	3314	137
		1170	34.8	40.7	5375	4837	132
		1755	35.6	62.5	7754	6831	124
		2340	36.1	84.6	9776	8400	116
BXRC-40H4000-D-7x	97	525	27.7	14.6	2080	1900	143
		700	28.2	19.8	2716	2469	137
		1050	29.0	30.5	4019	3617	132
		1575	30.4	47.9	5942	5234	124
		2100	31.5	66.2	7654	6576	116
BXRC-40A4001-B-73	80	450	33.2	14.9	2313	2113	155
		600	34.0	20.4	3038	2762	149
		900	34.8	31.3	4479	4031	143
		1350	35.6	48.1	6462	5692	134
		1800	36.1	65.1	8147	7000	125

Notes for Table 4:

1. Alternate drive currents are provided for reference only and are not a guarantee of performance.
2. Bridgelux maintains a $\pm 7\%$ tolerance on flux measurements.
3. Typical stabilized DC performance values are provided as reference only and are not a guarantee of performance.

Performance at Commonly Used Drive Currents

Table 4: Product Performance at Commonly Used Drive Currents (Continued)

Part Number	CRI	Drive Current ¹ (mA)	Typical V _f T _c = 25°C (V)	Typical Power T _c = 25°C (W)	Typical Flux ² T _c = 25°C (lm)	Typical DC Flux ³ T _c = 85°C (lm)	Typical Efficacy T _c = 25°C (lm/W)
BXRC-40A4001-C-73	80	585	33.2	19.4	3007	2747	155
		780	34.0	26.5	3949	3591	149
		1170	34.8	40.7	5822	5240	143
		1755	35.6	62.5	8400	7400	134
		2340	36.1	84.6	10591	9100	125
BXRC-40A4001-D-73	80	525	27.7	14.6	2253	2059	155
		700	28.2	19.8	2942	2675	149
		1050	29.0	30.5	4354	3919	143
		1575	30.4	47.9	6437	5671	134
		2100	31.5	66.2	8292	7124	125
BXRC-50C4001-B-74	70	450	33.2	14.9	2977	2719	199
		600	34.0	20.4	3909	3554	192
		900	34.8	31.3	5763	5187	184
		1350	35.6	48.1	8314	7324	173
		1800	36.1	65.1	10483	9007	161
BXRC-50C4001-C-74	70	585	33.2	19.4	3869	3535	199
		780	34.0	26.5	5082	4620	192
		1170	34.8	40.7	7492	6743	184
		1755	35.6	62.5	10808	9521	173
		2340	36.1	84.6	13628	11709	161
BXRC-50C4001-D-74	70	525	27.7	14.6	2899	2649	199
		700	28.2	19.8	3785	3441	192
		1050	29.0	30.5	5603	5043	184
		1575	30.4	47.9	8283	7297	173
		2100	31.5	66.2	10669	9167	161
BXRC-50E4001-B-74	80	450	33.2	14.9	2863	2616	192
		600	34.0	20.4	3760	3419	184
		900	34.8	31.3	5544	4989	177
		1350	35.6	48.1	7998	7046	166
		1800	36.1	65.1	10084	8664	155
BXRC-50E4001-C-7x	80	585	33.2	19.4	3722	3401	192
		780	34.0	26.5	4888	4444	184
		1170	34.8	40.7	7207	6486	177
		1755	35.6	62.5	10397	9159	166
		2340	36.1	84.6	13109	11264	155
BXRC-50E4001-D-7x	80	525	27.7	14.6	2789	2548	192
		700	28.2	19.8	3641	3311	184
		1050	29.0	30.5	5390	4851	177
		1575	30.4	47.9	7968	7019	166
		2100	31.5	66.2	10263	8818	155
BXRC-50G4001-B-7x	90	450	33.2	14.9	2475	2261	166
		600	34.0	20.4	3250	2955	159
		900	34.8	31.3	4792	4313	153
		1350	35.6	48.1	6913	6090	144
		1800	36.1	65.1	8717	7490	134

Notes for Table 4:

1. Alternate drive currents are provided for reference only and are not a guarantee of performance.
2. Bridgelux maintains a ± 7% tolerance on flux measurements.
3. Typical stabilized DC performance values are provided as reference only and are not a guarantee of performance.

Performance at Commonly Used Drive Currents

Table 4: Product Performance at Commonly Used Drive Currents (Continued)

Part Number	CRI	Drive Current ¹ (mA)	Typical V _f T _c = 25°C (V)	Typical Power T _c = 25°C (W)	Typical Flux ² T _c = 25°C (lm)	Typical DC Flux ³ T _c = 85°C (lm)	Typical Efficacy T _c = 25°C (lm/W)
BXRC-50G4001-C-7x	90	585	33.2	19.4	3218	2940	166
		780	34.0	26.5	4226	3842	159
		1170	34.8	40.7	6230	5607	153
		1755	35.6	62.5	8987	7917	144
		2340	36.1	84.6	11332	9736	134
BXRC-50G4001-D-7x	90	525	27.7	14.6	2411	2203	166
		700	28.2	19.8	3148	2862	159
		1050	29.0	30.5	4659	4193	153
		1575	30.4	47.9	6887	6067	144
		2100	31.5	66.2	8872	7623	134
BXRC-56G4000-B-74	90	450	33.2	14.9	2491	2276	167
		600	34.0	20.4	3272	2974	160
		900	34.8	31.3	4823	4341	154
		1350	35.6	48.1	6959	6130	145
		1800	36.1	65.1	8774	7539	135
BXRC-56G4000-C-74	90	585	33.2	19.4	3239	2959	167
		780	34.0	26.5	4253	3867	160
		1170	34.8	40.7	6270	5643	154
		1755	35.6	62.5	9046	7969	145
		2340	36.1	84.6	11406	9800	135
BXRC-56G400x-D-74	90	525	27.7	14.6	2427	2217	167
		700	28.2	19.8	3168	2880	160
		1050	29.0	30.5	4689	4220	154
		1575	30.4	47.9	6932	6107	145
		2100	31.5	66.2	8930	7672	135
BXRC-56H4000-D-74	97	525	27.7	14.6	2190	2001	150
		700	28.2	19.8	2860	2600	145
		1050	29.0	30.5	4233	3809	139
		1575	30.4	47.9	6257	5512	131
		2100	31.5	66.2	8060	6925	122
BXRC-57C4001-B-7x	70	450	33.2	14.9	2896	2646	194
		600	34.0	20.4	3803	3457	186
		900	34.8	31.3	5606	5046	179
		1350	35.6	48.1	8088	7125	168
		1800	36.1	65.1	10198	8762	157
BXRC-57C4001-C-7x	70	585	33.2	19.4	3764	3439	194
		780	34.0	26.5	4944	4495	186
		1170	34.8	40.7	7288	6559	179
		1755	35.6	62.5	10515	9263	168
		2340	36.1	84.6	13257	11391	157
BXRC-57C4001-D-7x	70	525	27.7	14.6	2821	2577	194
		700	28.2	19.8	3682	3348	186
		1050	29.0	30.5	5451	4905	179
		1575	30.4	47.9	8058	7098	168
		2100	31.5	66.2	10379	8918	157

Notes for Table 4:

1. Alternate drive currents are provided for reference only and are not a guarantee of performance.
2. Bridgelux maintains a ± 7% tolerance on flux measurements.
3. Typical stabilized DC performance values are provided as reference only and are not a guarantee of performance.

Performance at Commonly Used Drive Currents

Table 4: Product Performance at Commonly Used Drive Currents (Continued)

Part Number	CRI	Drive Current ¹ (mA)	Typical V_f $T_c = 25^\circ\text{C}$ (V)	Typical Power $T_c = 25^\circ\text{C}$ (W)	Typical Flux ² $T_c = 25^\circ\text{C}$ (lm)	Typical DC Flux ³ $T_c = 85^\circ\text{C}$ (lm)	Typical Efficacy $T_c = 25^\circ\text{C}$ (lm/W)
BXRC-57E4001-B-7x	80	450	33.2	14.9	2750	2512	184
		600	34.0	20.4	3612	3283	177
		900	34.8	31.3	5324	4792	170
		1350	35.6	48.1	7682	6767	160
BXRC-57E4001-C-7x	80	1800	36.1	65.1	9685	8322	149
		585	33.2	19.4	3575	3266	184
		780	34.0	26.5	4695	4269	177
		1170	34.8	40.7	6922	6230	170
BXRC-57E4001-D-7x	80	1755	35.6	62.5	9986	8797	160
		2340	36.1	84.6	12591	10818	149
		525	27.7	14.6	2679	2447	184
		700	28.2	19.8	3497	3180	177
BXRC-57E4001-D-7x	80	1050	29.0	30.5	5177	4659	170
		1575	30.4	47.9	7653	6741	160
		2100	31.5	66.2	9857	8470	149
		BXRC-65C4001-B-7x	70	450	33.2	14.9	2896
600	34.0			20.4	3803	3457	186
900	34.8			31.3	5606	5046	179
1350	35.6			48.1	8088	7125	168
BXRC-65C4001-C-7x	70	1800	36.1	65.1	10198	8762	157
		585	33.2	19.4	3764	3439	194
		780	34.0	26.5	4944	4495	186
		1170	34.8	40.7	7288	6559	179
BXRC-65C4001-D-7x	70	1755	35.6	62.5	10515	9263	168
		2340	36.1	84.6	13257	11391	157
		525	27.7	14.6	2821	2577	194
		700	28.2	19.8	3682	3348	186
BXRC-65C4001-D-7x	70	1050	29.0	30.5	5451	4905	179
		1575	30.4	47.9	8058	7098	168
		2100	31.5	66.2	10379	8918	157
		BXRC-65E4001-B-7x	80	450	33.2	14.9	2782
600	34.0			20.4	3654	3322	179
900	34.8			31.3	5387	4848	172
1350	35.6			48.1	7772	6847	162
BXRC-65E4001-C-7x	80	1800	36.1	65.1	9799	8420	151
		585	33.2	19.4	3617	3305	186
		780	34.0	26.5	4750	4319	179
		1170	34.8	40.7	7003	6303	172
BXRC-65E4001-D-7x	80	1755	35.6	62.5	10104	8901	162
		2340	36.1	84.6	12739	10946	151
		525	27.7	14.6	2710	2476	186
		700	28.2	19.8	3538	3217	179
BXRC-65E4001-D-7x	80	1050	29.0	30.5	5237	4714	172
		1575	30.4	47.9	7743	6821	162
		2100	31.5	66.2	9973	8569	151

Notes for Table 4:

1. Alternate drive currents are provided for reference only and are not a guarantee of performance.
2. Bridgelux maintains a $\pm 7\%$ tolerance on flux measurements.
3. Typical stabilized DC performance values are provided as reference only and are not a guarantee of performance.

Electrical Characteristics

Table 5: Electrical Characteristics

Part Number	Drive Current (mA)	Forward Voltage Pulsed, $T_c = 25^\circ\text{C}$ (V) ^{1, 2, 3, 8}			Typical Coefficient of Forward Voltage ⁴ $\Delta V_f / \Delta T_c$ (mV/ $^\circ\text{C}$)	Typical Thermal Resistance Junction to Case ^{5,6} R_{j-c} ($^\circ\text{C}/\text{W}$)	Driver Selection Voltages ⁷ (V)	
		Minimum	Typical	Maximum			V_f Min. Hot $T_c = 105^\circ\text{C}$ (V)	V_f Max. Cold $T_c = -40^\circ\text{C}$ (V)
BXRC-xxx400x-B-7x	900	32.2	34.8	37.4	-14.9	0.15	31.0	38.4
	1800	33.4	36.1	38.8	-14.9	0.19	32.2	39.8
BXRC-xxx400x-C-7x	1170	32.2	34.8	37.4	-14.9	0.11	31.0	38.4
	2340	33.4	36.1	38.8	-14.9	0.13	32.2	39.8
BXRC-xxx400x-D-7x	1050	26.8	29.0	31.2	-12.2	0.16	25.8	32.0
	2100	29.2	31.5	33.9	-12.2	0.19	28.2	34.7

Notes for Table 5:

- Parts are tested in pulsed conditions, $T_c = 25^\circ\text{C}$. Pulse width is 10ms.
- Voltage minimum and maximum are provided for reference only and are not a guarantee of performance.
- Bridgelux maintains a tester tolerance of $\pm 0.10\text{V}$ on forward voltage measurements.
- Typical coefficient of forward voltage tolerance is $\pm 0.1\text{mV}$ for nominal current.
- Thermal resistance values are based from test data of a 3000K 80 CRI product.
- Thermal resistance value was calculated using total electrical input power; optical power was not subtracted from input power. The thermal interface material used during testing is not included in the thermal resistance value.
- V_f min hot and max cold values are provided as reference only and are not guaranteed by test. These values are provided to aid in driver design and selection over the operating range of the product.
- This product has been designed and manufactured per IEC 62031:2014. This product has passed dielectric withstand voltage testing at 1160 V. The working voltage designated for the insulation is 80V d.c. The maximum allowable voltage across the array must be determined in the end product application.

Eye Safety

Table 6: Eye Safety Risk Group (RG) Classifications

Part Number	Drive Current ⁵ (mA)	CCT ^{1,5}			
		2700K/3000K	4000K ²	5000K ³	6500K ⁴
BXRC-xxx400x-B-7x	900	RG1	RG1	RG1	RG1
	1350	RG1	RG1	RG1	RG2
	1800	RG1	RG1	RG2	RG2
BXRC-xxx400x-C-7x	1170	RG1	RG1	RG1	RG1
	1755	RG1	RG1	RG2	RG2
	2340	RG1	RG1	RG2	RG2
BXRC-xxx400x-D-7x	1050	RG1	RG1	RG1	RG1
	1575	RG1	RG1	RG1	RG2
	2100	RG1	RG1	RG2	RG2

Notes for Table 6:

1. Eye safety classification for the use of Bridgelux Vero Series LED arrays is in accordance with specification IEC/TR 62778: Application of IEC 62471 for the assessment of blue light hazard to light sources and luminaires.
2. For products classified as RG2 at 4000K, $E_{thr} = 1847.5$ lx.
3. For products classified as RG2 at 5000K $E_{thr} = 1315.8$ lx.
4. For products classified as RG2 at 6500K, $E_{thr} = 1124.5$ lx.
5. Please contact your Bridgelux sales representative for E_{thr} values at specific drive currents and CCTs not listed.

Absolute Maximum Ratings

Table 7: Maximum Ratings

Parameter	Maximum Rating		
LED Junction Temperature (T_j)	150°C		
Storage Temperature	-40°C to +105°C		
Operating Case Temperature ¹ (T_c)	105°C		
Soldering Temperature ²	300°C or lower for a maximum of 6 seconds		
	BXRC-xxx400x-B-7x	BXRC-xxx400x-C-7x	BXRC-xxx400x-D-7x
Maximum Drive Current ³	1800mA	2340mA	2100mA
Maximum Peak Pulsed Drive Current ⁴	2570mA	3340mA	3000mA
Maximum Reverse Voltage ⁵	-60V	-60V	-50V

Notes for Table 7:

1. For IEC 62717 requirement, please consult your Bridgelux sales representative.
2. Refer to Bridgelux Application Note AN31: Assembly Considerations for Bridgelux Vero LED Arrays.
3. Arrays may be driven at higher currents however lumen maintenance may be reduced.
4. Bridgelux recommends a maximum duty cycle of 10% and pulse width of 20 ms when operating LED Arrays at maximum peak pulsed current specified. Maximum peak pulsed currents indicate values where LED Arrays can be driven without catastrophic failures.
5. Light emitting diodes are not designed to be driven in reverse voltage and will not produce light under this condition. Maximum rating provided for reference only.

Performance Curves

Figure 1: Vero 18B Drive Current vs. Voltage

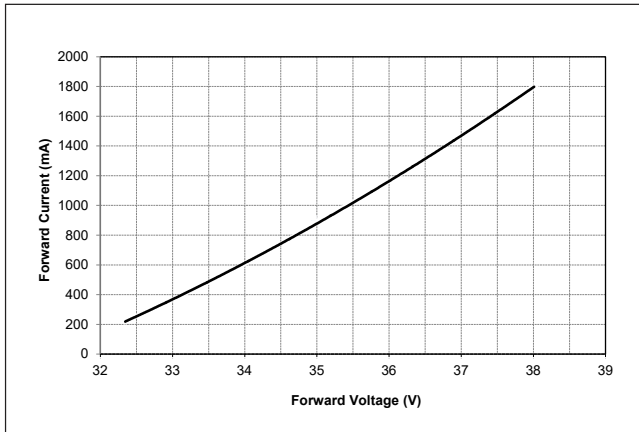

Figure 2: Vero 18C Drive Current vs. Voltage

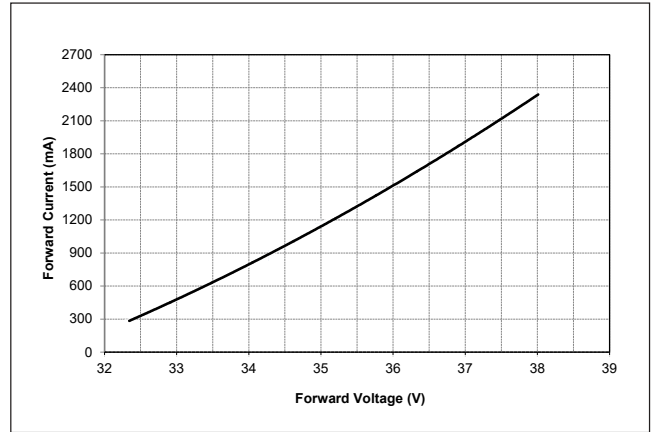

Figure 3: Vero 18D Drive Current vs. Voltage

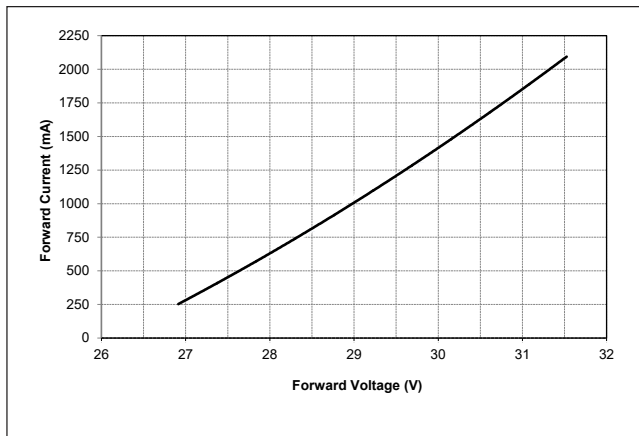

Figure 4: Vero 18B Typical Relative Flux vs. Current

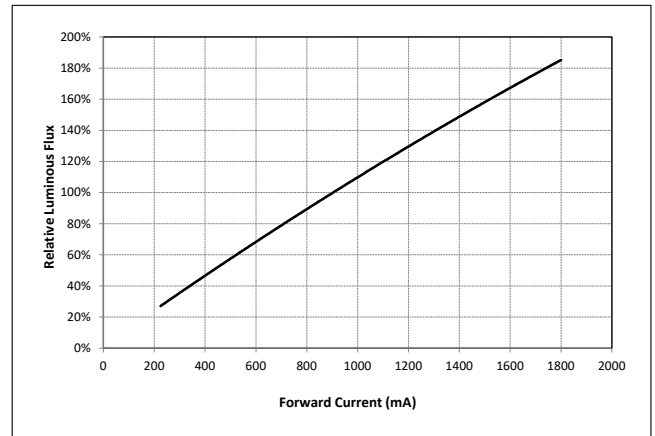

Figure 5: Vero 18C Typical Relative Flux vs. Current

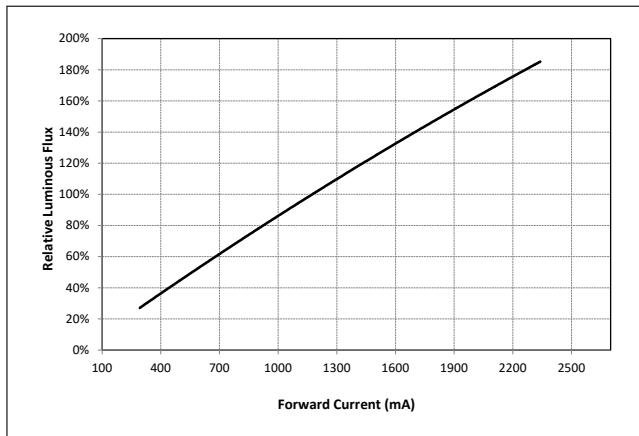
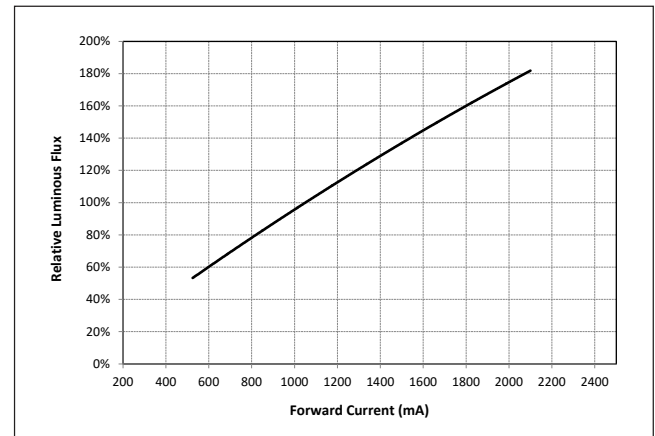

Figure 6: Vero 18D Typical Relative Flux vs. Current



Notes for Figures 1-6:

1. Bridgelux does not recommend driving high power LEDs at low currents. Doing so may produce unpredictable results. Pulse width modulation (PWM) is recommended for dimming effects.
2. Products tested under pulsed condition (10ms pulse width) at nominal test current where T_j (junction temperature) = T_c (case temperature) = 25°C.

Performance Curves

Figure 7: Typical DC Flux vs. Case Temperature

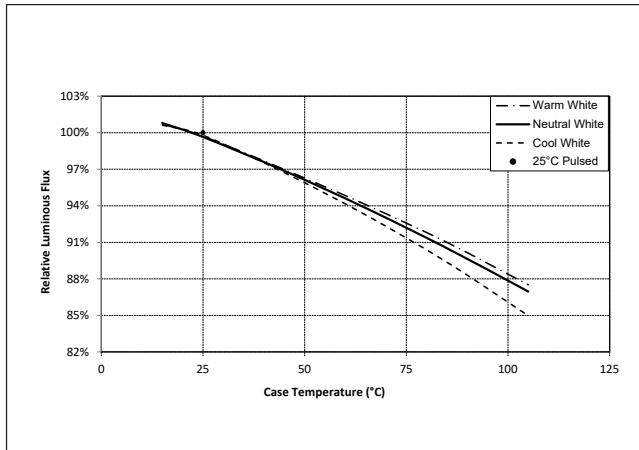

Figure 8: Typical DC ccy Shift vs. Case Temperature

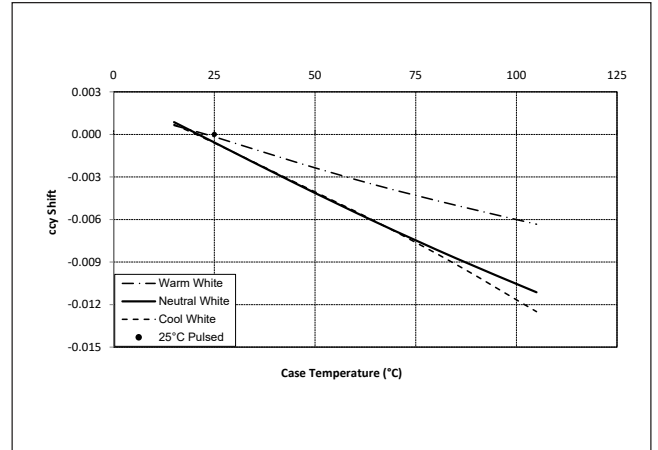
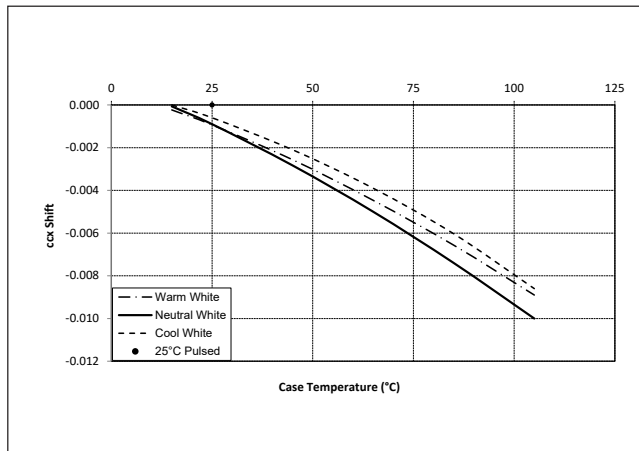

Figure 9: Typical DC ccx Shift vs. Case Temperature



Notes for Figures 7-9:

1. Characteristics shown for warm white based on 3000K and 80 CRI.
2. Characteristics shown for neutral white based on 4000K and 80 CRI.
3. Characteristics shown for cool white based on 5000K and 70 CRI.
4. For other color SKUs, the shift in color will vary. Please contact your Bridgelux Sales Representative for more information.

Performance Curves

Figure 10: 1750K Color Shift vs. Case Temperature¹

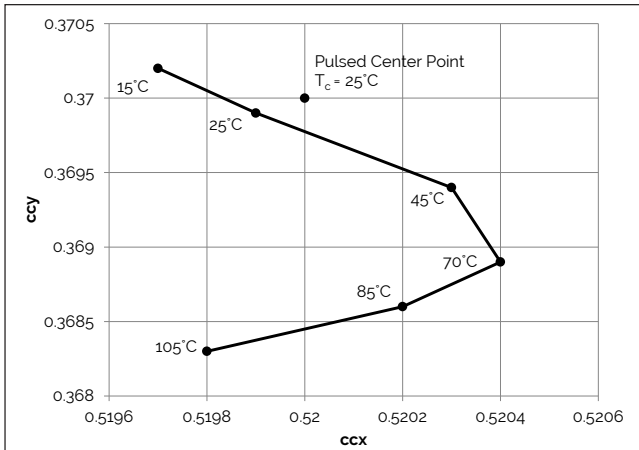

Figure 11: 2000K, 65 CRI Color Shift vs. Case Temperature

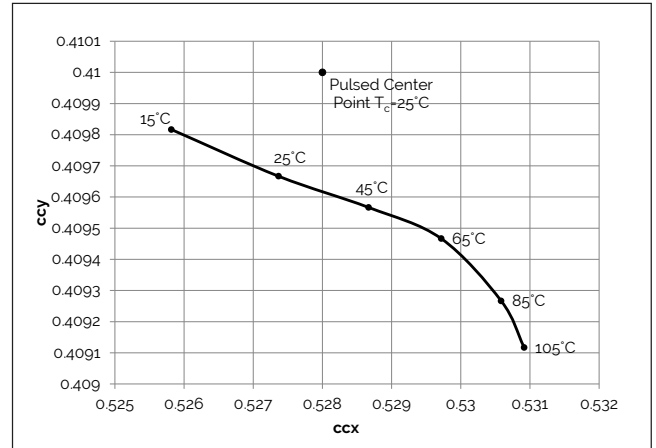

Figure 12: 2500K Color Shift vs. Case Temperature¹

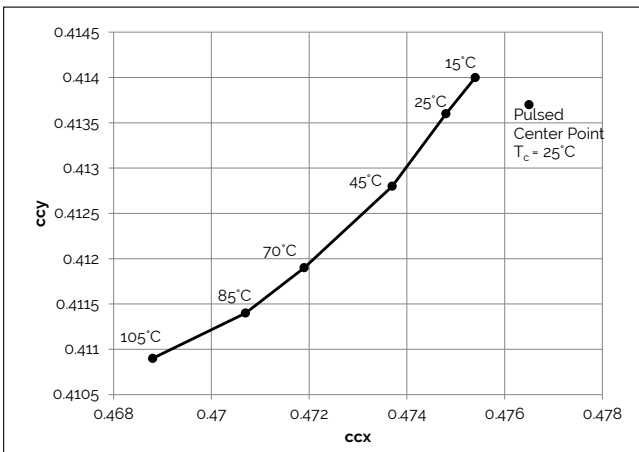

Figure 13: 3000K, 90 CRI Color Shift vs. Case Temperature^{1,3}

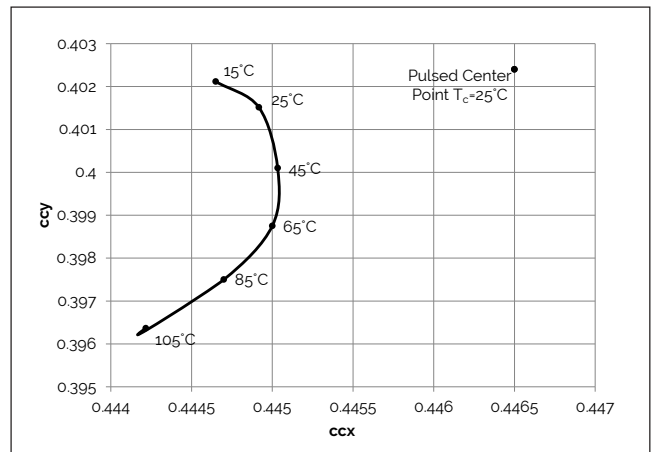

Figure 14: 2700K, 97 CRI Color Shift vs. Case Temperature¹

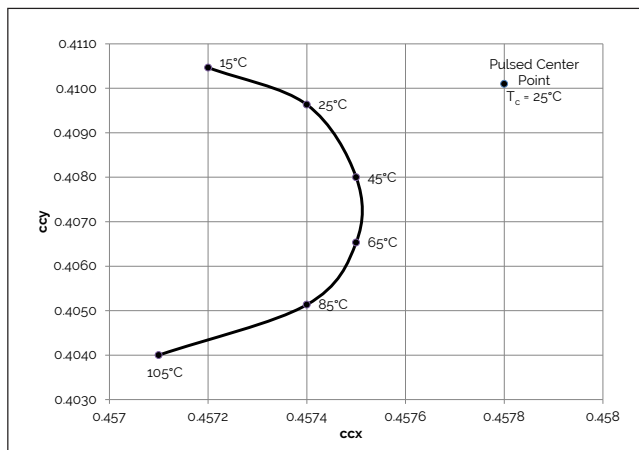
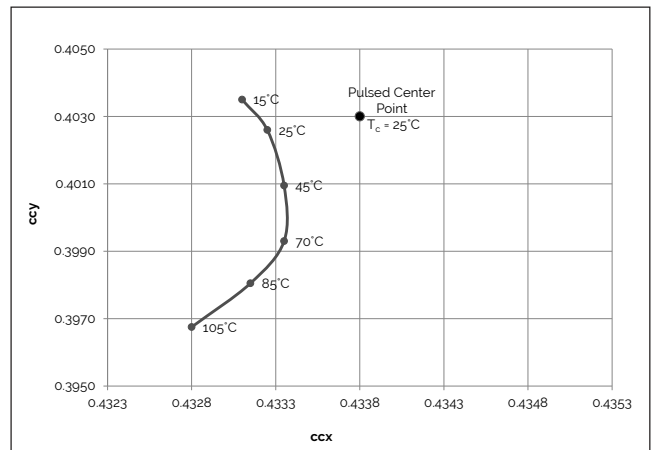

Figure 15: 3000K, 97 CRI Color Shift vs. Case Temperature¹



Note for Figures 10-15:

1. Measurements made under DC test conditions at the nominal drive current.
2. Typical color shift is shown with a tolerance of ± 0.002 .
3. Characteristics shown for Decor Series Showcase products, BXRC-30G400C-x-73

Performance Curves

Figure 16: 5600K Color Shift vs. Case Temperature^{1,3}

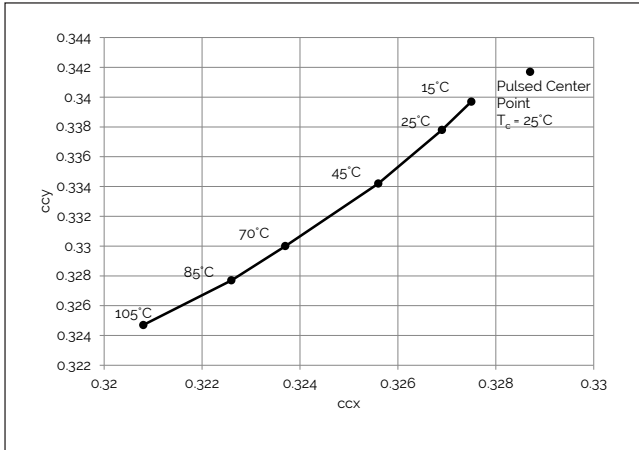

Figure 17: 3000K Class A Color Shift vs. Case Temperature¹

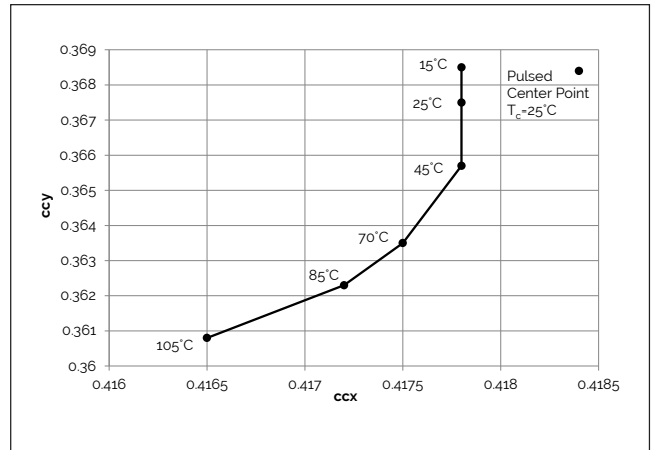

Figure 18: 3500K Class A Color Shift vs. Case Temperature¹

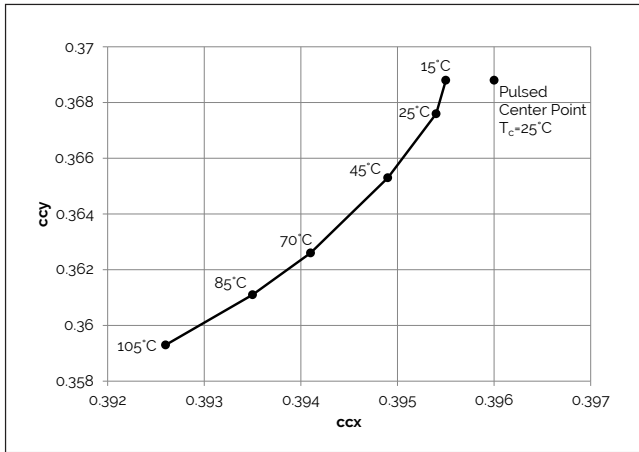
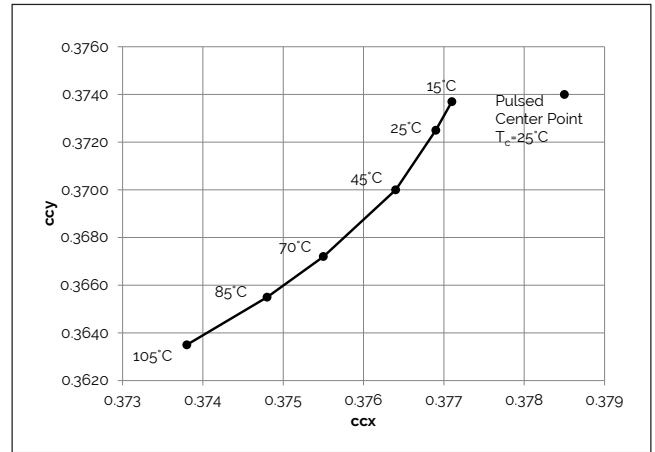

Figure 19: 4000K Class A Color Shift vs. Case Temperature¹



Note for Figures 16-19:

1. Measurements made under DC test conditions at the nominal drive current.
2. Typical color shift is shown with a tolerance of ± 0.002 .
3. Color shift shown for product hot targeted at $T_c = 85^\circ\text{C}$

Typical Radiation Pattern

Figure 20: Typical Spatial Radiation Pattern

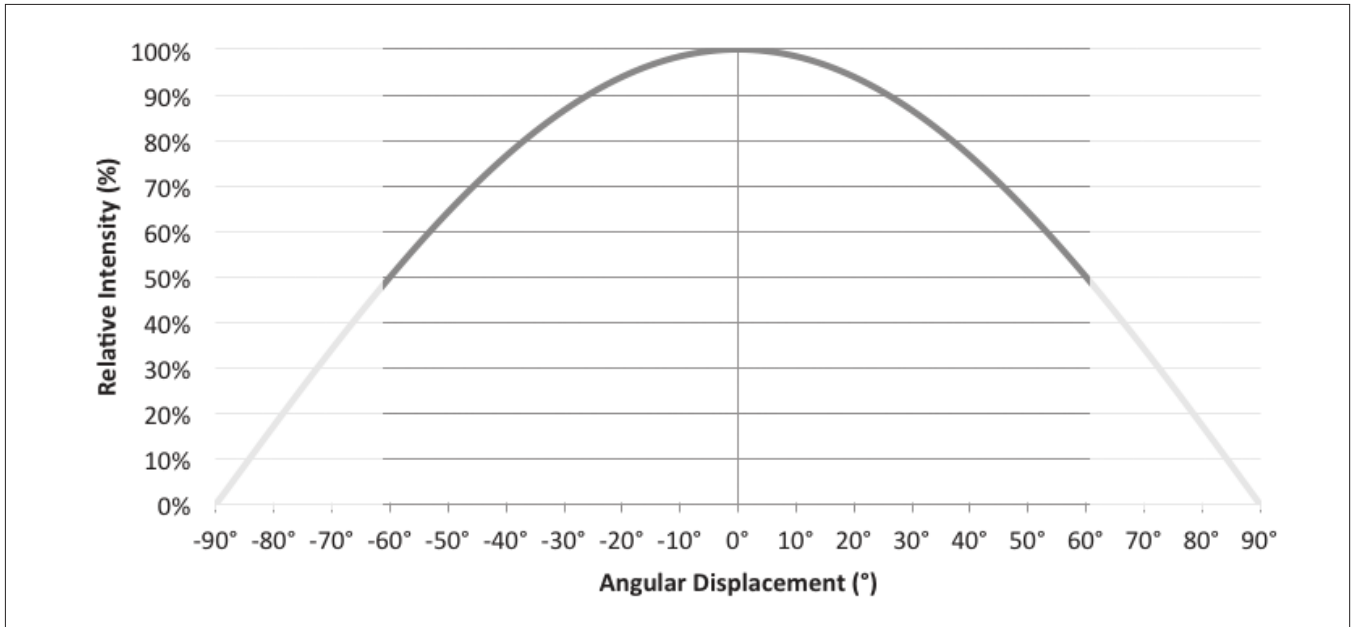

Note for Figure 20:

1. Typical viewing angle is 120°.
2. The viewing angle is defined as the off axis angle from the centerline where intensity is ½ of the peak value.

Figure 21: Typical Polar Radiation Pattern

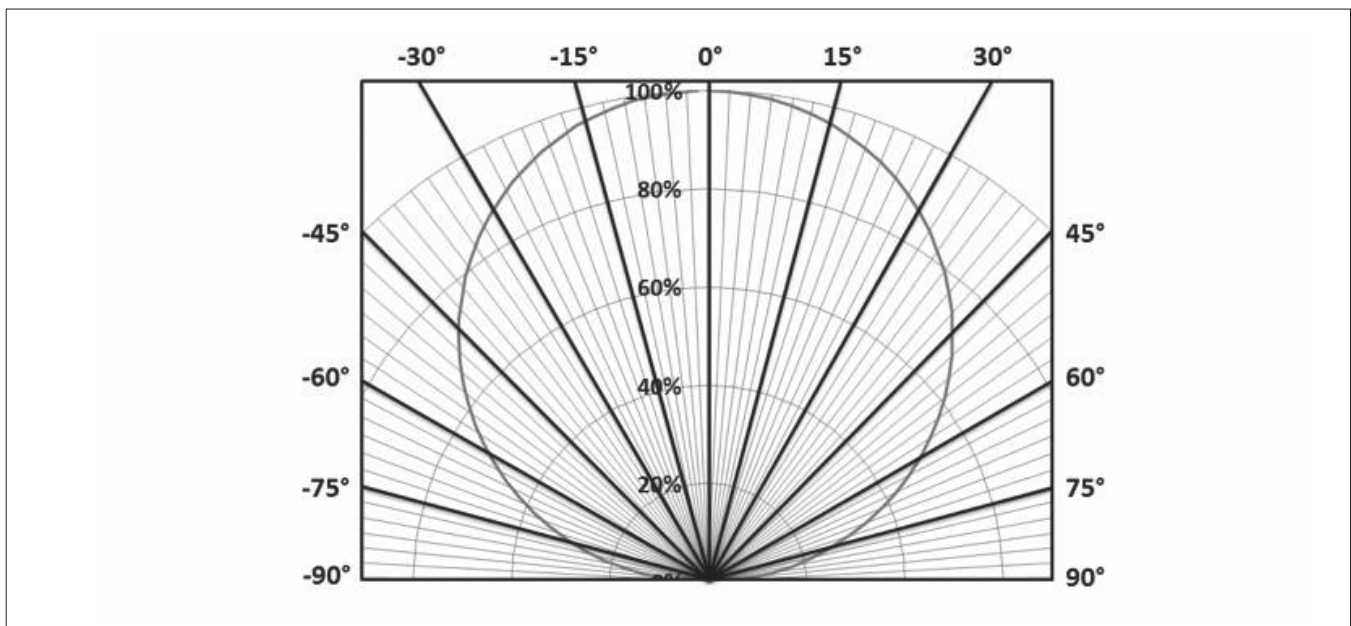

Typical Color Spectrum

Figure 22: Typical Color Spectrum

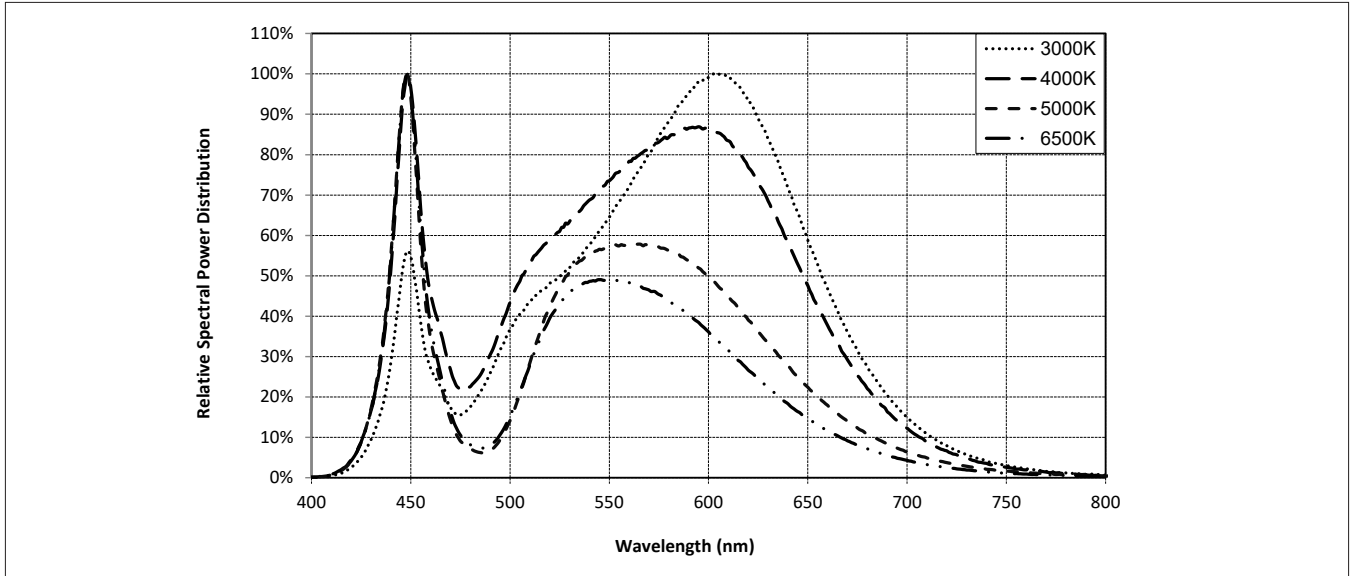

Note for Figure 22:

1. Color spectra measured at nominal current for $T_j = T_c = 25^\circ\text{C}$.
2. Color spectra shown is 3000K and 80 CRI.
3. Color spectra shown is 4000K and 80 CRI.
4. Color spectra shown is 5000K and 70 CRI.
4. Color spectra shown is 6500K and 70 CRI.

Figure 23: Typical Color Spectrum for Vero 18 with Décor Series

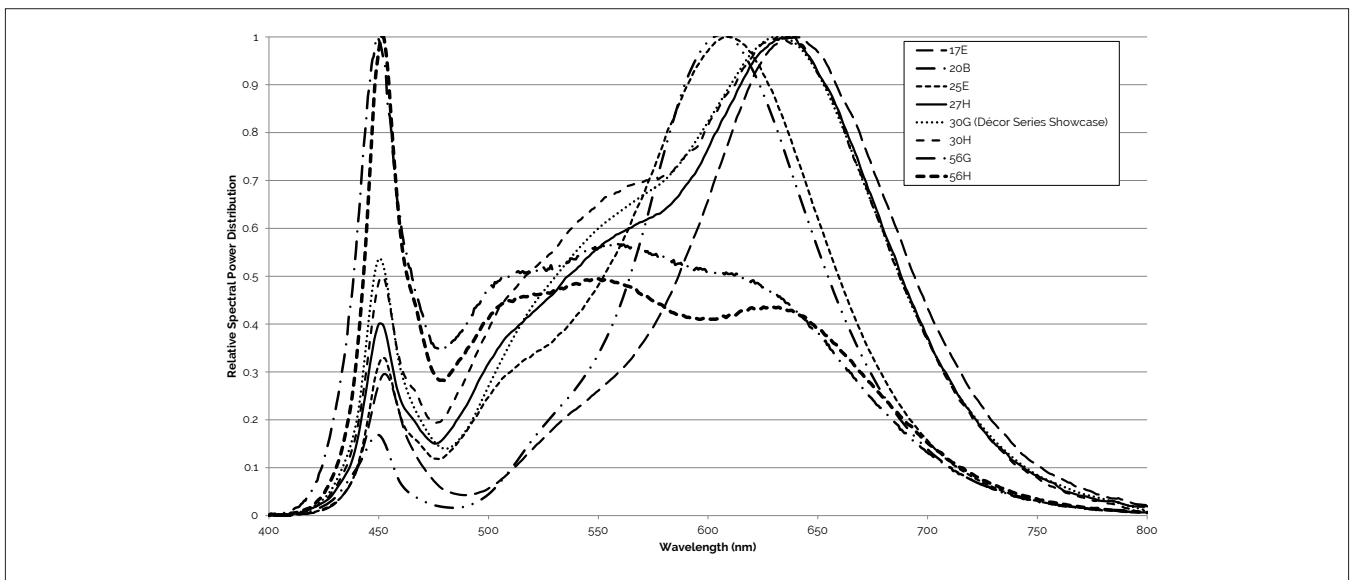

Note for Figure 23:

1. Color spectra measured at nominal current for $T_j = T_c = 25^\circ\text{C}$.

Mechanical Dimensions

Figure 24: Drawing for Vero 18 LED Array

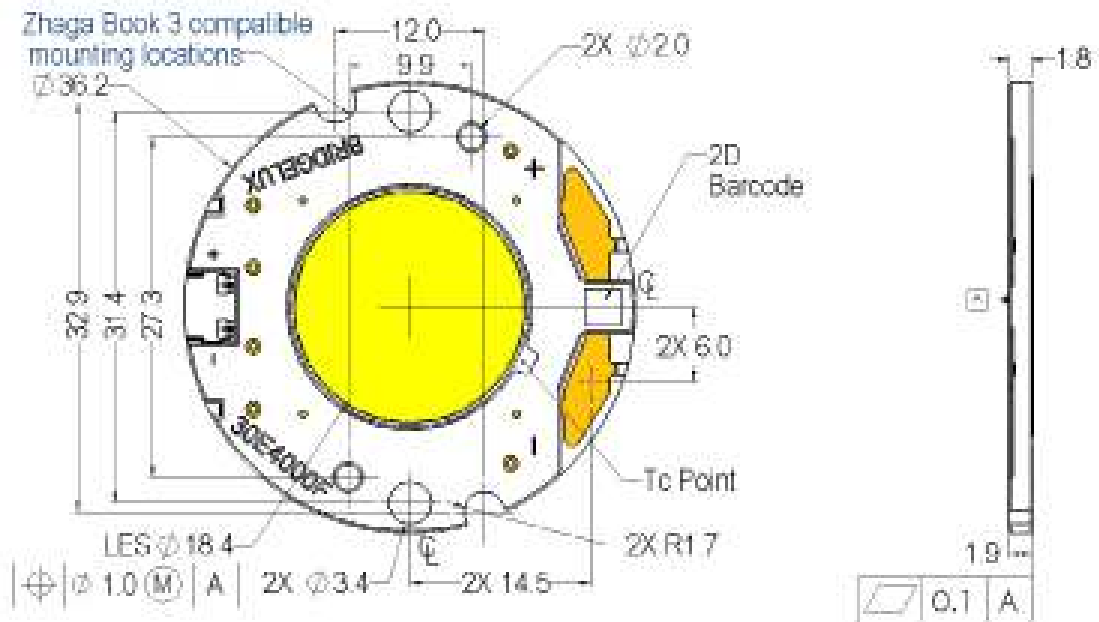

Notes for Figure 24:

1. Drawings are not to scale.
2. Drawing dimensions are in millimeters.
3. Unless otherwise specified, tolerances are ± 0.1 mm.
4. Mounting holes (2X) are for M2.5 screws.
5. Bridgelux recommends two tapped holes for mounting screws with 31.4 ± 0.10 mm center-to-center spacing.
6. Screws with flat shoulders (pan, dome, button, round, truss, mushroom) provide optimal torque control. Do NOT use flat, countersink, or raised head screws.
7. Solder pads and connector port are labeled "+" and "-" to denote positive and negative, respectively.
8. It is not necessary to provide electrical connections to both the solder pads and the connector port. Either set may be used depending on application specific design requirements.
9. Refer to Application Notes AN30 and AN31 for product handling, mounting and heat sink recommendations.
10. The optical center of the LED Array is nominally defined by the mechanical center of the array to a tolerance of ± 0.2 mm.
11. Bridgelux maintains a flatness of 0.10mm across the mounting surface of the array.

Color Binning Information

Figure 25: Warm and Neutral White Test Bins in xy Color Space

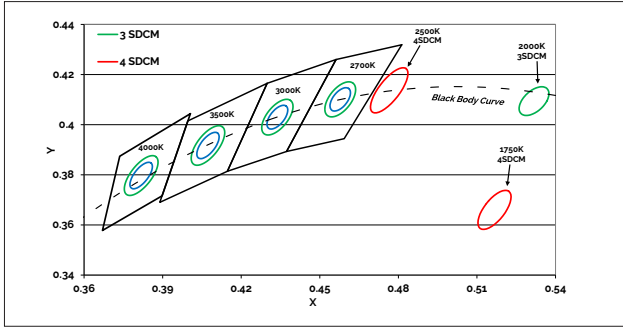

Note: Pulsed Test Conditions, $T_c = 25^\circ\text{C}$

Table 8: Warm and Neutral White xy Bin Coordinates and Associated Typical CCT

Bin Code	1750K	2000K	2500K	2700K	3000K ¹	3500K ¹	4000K ¹
ANSI Bin (for reference only)	-	-	-	(2580K - 2870K)	(2870K - 3220K)	(3220K - 3710K)	(3710K - 4260K)
73 (3 SDCM)	-	-	-	(2651K - 2794K)	(2968K - 3136K)	(3369K - 3586K)	(3851K - 4130K)
72 (2 SDCM)	-	-	-	(2674K - 2769K)	(2995K - 3107K)	(3404K - 3548K)	(3895K - 4081K)
Center Point (x,y)	(0.5167, 0.366)	(0.5280, 0.4100)	(0.4765, 0.4137)	(0.4578, 0.4101)	(0.4338, 0.403) (0.4465, 0.4024) ²	(0.4073, 0.3917)	(0.3818, 0.3797)

Note for Table 8:

- Color Binning information excludes Decor Series Class A products. Please contact your Bridgelux Sales Representative for more information.
- Center Point for Decor Series Showcase.

Figure 26: Cool White Test Bins in xy Color Space

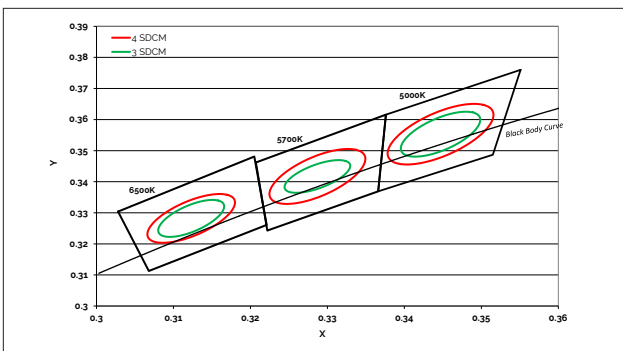

Note: Pulsed Test Conditions, $T_c = 25^\circ\text{C}$

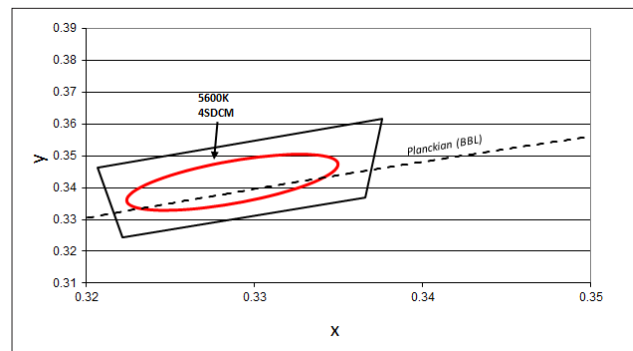

Note: Pulsed Test Conditions, $T_c = 25^\circ\text{C}$

Table 9: Cool White xy Bin Coordinates and Associated Typical CCT (product is hot targeted to $T_c = 85^\circ\text{C}$)

Bin Code	5000K	5600K	5700K	6500K
ANSI Bin (for reference only)	(4745K - 5311K)	(5310K - 6020K)	(5312K - 6022K)	(6022K - 7042K)
74 (4 SDCM)	(4801K - 5282K)	(5475K - 5830K)	(5481K - 5829K)	(6270K - 6765K)
73 (3 SDCM)	(4835K - 5215K)	(5490K - 5820K)	(5490K - 5820K)	(6250K - 6745K)
Center Point (x,y)	(0.3447, 0.3553)	(0.3293, 0.3423)	(0.3287, 0.3417)	(0.3123, 0.3282)

Note for Table 9:

- Select configurations with a CCT of 5600K are available with center point targets at $T_c = 85^\circ\text{C}$ or $T_c = 25^\circ\text{C}$.

Packaging and Labeling

Figure 27: Drawing for Vero 18 Packaging Tray

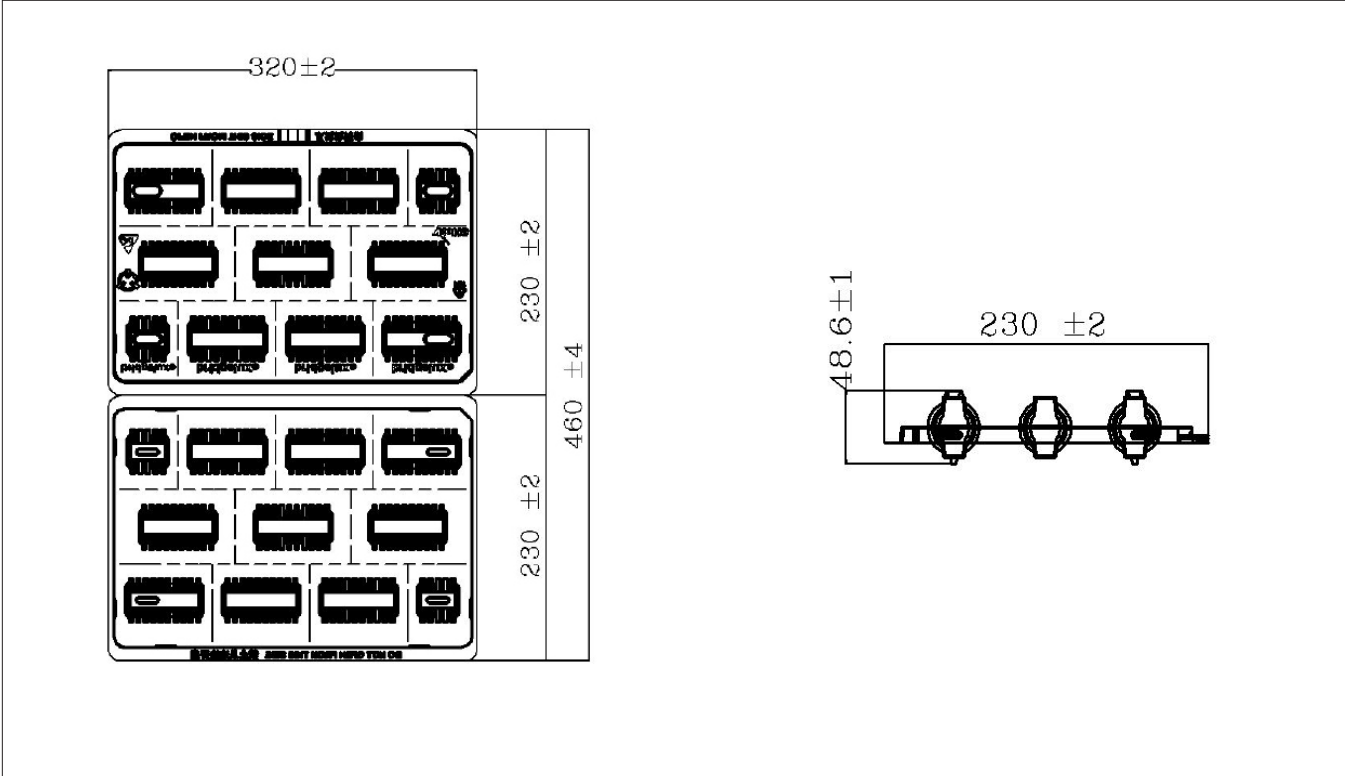

- Notes for Figure 27:
- 1. Dimensions are in millimeters.
 - 2. Drawings are not to scale.

Packaging and Labeling

Figure 28: Vero Series Packaging and Labeling

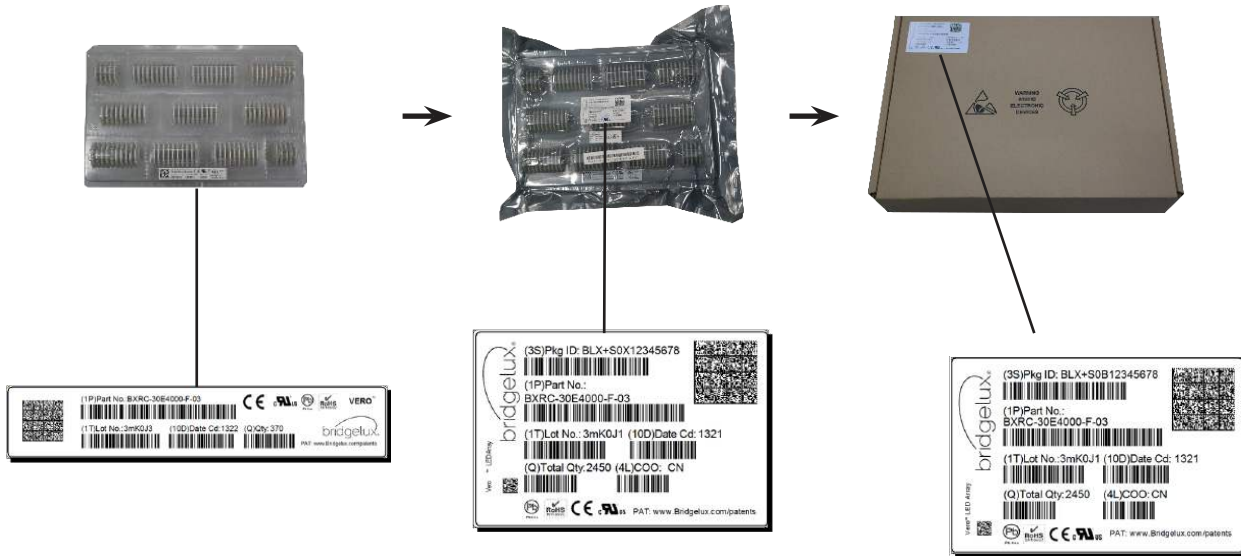

Notes for Figure 28:

1. Each tray holds 100 COBs.
2. Each tray is vacuum sealed in an anti-static bag and placed in its own box.
3. Each tray, bag and box is to be labeled as shown above.

Figure 29: Gen. 7 Product Labeling

Bridgelux COB arrays have laser markings on the back side of the substrate to help with product identification. In addition to the product identification markings, Bridgelux COB arrays also contain markings for internal Bridgelux manufacturing use only. The image below shows which markings are for customer use and which ones are for Bridgelux internal use only. The Bridgelux internal manufacturing markings are subject to change without notice, however these will not impact the form, function or performance of the COB array.



Customer Use- 2D Barcode
Scannable barcode provides product part number and other Bridgelux internal production information.

Customer Use- Product part number

30E4000C 73 2F

Customer Use- V_f Bin Code
included to enable greater luminaire design flexibility. Refer to ANG2 for bin code definitions.

Design Resources

Application Notes

Bridgelux has developed a comprehensive set of application notes and design resources to assist customers in successfully designing with the Vero product family of LED array products. For all available application notes visit www.bridgelux.com.

Optical Source Models

Optical source models and ray set files are available for all Bridgelux products. For a list of available formats, visit www.bridgelux.com.

3D CAD Models

Three dimensional CAD models depicting the product outline of all Bridgelux Vero LED arrays are available in both IGS and STEP formats. Please contact your Bridgelux sales representative for assistance.

LM80

LM80 testing has been completed and the LM80 report is now available. Please contact your Bridgelux sales representative for LM-80 report.

Precautions

CAUTION: CHEMICAL EXPOSURE HAZARD

Exposure to some chemicals commonly used in luminaire manufacturing and assembly can cause damage to the LED array. Please consult Bridgelux Application Note AN31 for additional information.

CAUTION: RISK OF BURN

Do not touch the Vero LED array during operation. Allow the array to cool for a sufficient period of time before handling. The Vero LED array may reach elevated temperatures such that could burn skin when touched.

CAUTION

CONTACT WITH LIGHT EMITTING SURFACE (LES)

Avoid any contact with the LES. Do not touch the LES of the LED array or apply stress to the LES (yellow phosphor resin area). Contact may cause damage to the LED array.

Optics and reflectors must not be mounted in contact with the LES (yellow phosphor resin area). Optical devices may be mounted on the top surface of the plastic housing of the Vero LED array. Use the mechanical features of the LED array housing, edges and/or mounting holes to locate and secure optical devices as needed.

Disclaimers

MINOR PRODUCT CHANGE POLICY

The rigorous qualification testing on products offered by Bridgelux provides performance assurance. Slight cosmetic changes that do not affect form, fit, or function may occur as Bridgelux continues product optimization.

STANDARD TEST CONDITIONS

Unless otherwise stated, array testing is performed at the nominal drive current.

About Bridgelux: Bridging Light and Life™

At Bridgelux, we help companies, industries and people experience the power and possibility of light. Since 2002, we've designed LED solutions that are high performing, energy efficient, cost effective and easy to integrate. Our focus is on light's impact on human behavior, delivering products that create better environments, experiences and returns—both experiential and financial. And our patented technology drives new platforms for commercial and industrial luminaires.

For more information about the company, please visit
bridgelux.com
twitter.com/Bridgelux
facebook.com/Bridgelux
youtube.com/user/Bridgelux
linkedin.com/company/bridgelux-inc-_2
WeChat ID: BridgeluxInChina



46430 Fremont Boulevard
Fremont, CA 94538 U.S.A.
Tel (925) 583-8400
www.bridgelux.com

© 2016-2019 Bridgelux, Inc. All rights reserved. Product specifications are subject to change without notice. Bridgelux, the Bridgelux stylized logo design, Vero, V Series and V Series HD are registered trademarks, and Decor Series is a trademark of Bridgelux, Inc. All other trademarks are the property of their respective owners.

Bridgelux Gen 7 Vero 18 Array Series Product Data Sheet DSg2 Rev. Q (09/2020)