



CAT93C66 (Die Rev. E)

4K-Bit Microwire Serial EEPROM

FEATURES

- High speed operation: 1MHz
- Low power CMOS technology
- 1.8 to 6.0 volt operation
- Selectable x8 or x16 memory organization
- Self-timed write cycle with auto-clear
- Hardware and software write protection
- Power-up inadvertant write protection
- 1,000,000 Program/erase cycles
- 100 year data retention
- Commercial, industrial and automotive temperature ranges
- Sequential read
- “Green” package option available

DESCRIPTION

The CAT93C66 is a 4K-bit Serial EEPROM memory device which is configured as either registers of 16 bits (ORG pin at V_{CC}) or 8 bits (ORG pin at GND). Each register can be written (or read) serially by using the DI (or DO) pin. The CAT93C66 is manufactured using

Catalyst’s advanced CMOS EEPROM floating gate technology. The devices are designed to endure 1,000,000 program/erase cycles and has a data retention of 100 years. The devices are available in 8-pin DIP, 8-pin SOIC, 8-pin TSSOP and 8-pad TDFN packages.

PIN CONFIGURATION

DIP Package (P, L)

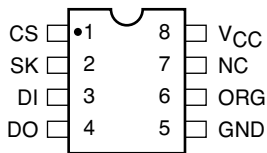

SOIC Package (J,W)

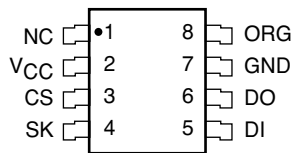

SOIC Package (S,V)

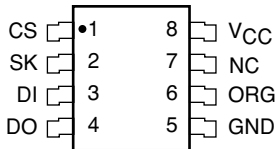

SOIC Package (K,X)

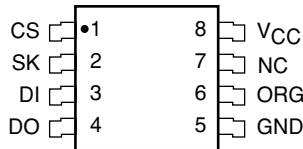

TSSOP Package (U,Y)



TDFN Package (RD4, ZD4)

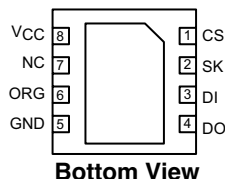

FUNCTIONAL SYMBOL

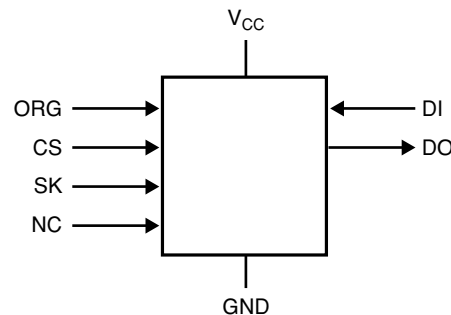

PIN FUNCTIONS

Pin Name	Function
CS	Chip Select
SK	Clock Input
DI	Serial Data Input
DO	Serial Data Output
V _{CC}	+1.8 to 6.0V Power Supply
GND	Ground
ORG	Memory Organization
NC	No Connection

Note: When the ORG pin is connected to V_{CC}, the x16 organization is selected. When it is connected to ground, the x8 pin is selected. If the ORG pin is left unconnected, then an internal pullup device will select the x16 organization.

ABSOLUTE MAXIMUM RATINGS*

Temperature Under Bias -55°C to +125°C
 Storage Temperature -65°C to +150°C
 Voltage on any Pin with
 Respect to Ground⁽¹⁾ -2.0V to +V_{CC} +2.0V
 V_{CC} with Respect to Ground -2.0V to +7.0V
 Package Power Dissipation
 Capability (T_A = 25°C) 1.0W
 Lead Soldering Temperature (10 secs) 300°C
 Output Short Circuit Current⁽²⁾ 100 mA

***COMMENT**

Stresses above those listed under “Absolute Maximum Ratings” may cause permanent damage to the device. These are stress ratings only, and functional operation of the device at these or any other conditions outside of those listed in the operational sections of this specification is not implied. Exposure to any absolute maximum rating for extended periods may affect device performance and reliability.

RELIABILITY CHARACTERISTICS

Symbol	Parameter	Reference Test Method	Min	Typ	Max	Units
N _{END} ⁽³⁾	Endurance	MIL-STD-883, Test Method 1033	1,000,000			Cycles/Byte
T _{DR} ⁽³⁾	Data Retention	MIL-STD-883, Test Method 1008	100			Years
V _{ZAP} ⁽³⁾	ESD Susceptibility	MIL-STD-883, Test Method 3015	2000			Volts
I _{LTH} ⁽³⁾⁽⁴⁾	Latch-Up	JEDEC Standard 17	100			mA

D.C. OPERATING CHARACTERISTICS

V_{CC} = +1.8V to +6.0V, unless otherwise specified.

Symbol	Parameter	Test Conditions	Min	Typ	Max	Units
I _{CC1}	Power Supply Current (Write)	f _{SK} = 1MHz V _{CC} = 5.0V			3	mA
I _{CC2}	Power Supply Current (Read)	f _{SK} = 1MHz V _{CC} = 5.0V			500	μA
I _{SB1}	Power Supply Current (Standby) (x8 Mode)	CS = 0V ORG=GND			10	μA
I _{SB2}	Power Supply Current (Standby) (x16Mode)	CS=0V ORG=Float or V _{CC}		0	10	μA
I _{LI}	Input Leakage Current	V _{IN} = 0V to V _{CC}			1	μA
I _{LO}	Output Leakage Current (Including ORG pin)	V _{OUT} = 0V to V _{CC} , CS = 0V			1	μA
V _{IL1}	Input Low Voltage	4.5V ≤ V _{CC} < 5.5V	-0.1		0.8	V
V _{IH1}	Input High Voltage	4.5V ≤ V _{CC} < 5.5V	2		V _{CC} + 1	V
V _{IL2}	Input Low Voltage	1.8V ≤ V _{CC} < 4.5V	0		V _{CC} x 0.2	V
V _{IH2}	Input High Voltage	1.8V ≤ V _{CC} < 4.5V	V _{CC} x 0.7		V _{CC} +1	V
V _{OL1}	Output Low Voltage	4.5V ≤ V _{CC} < 5.5V I _{OL} = 2.1mA			0.4	V
V _{OH1}	Output High Voltage	4.5V ≤ V _{CC} < 5.5V I _{OH} = -400μA	2.4			V
V _{OL2}	Output Low Voltage	1.8V ≤ V _{CC} < 4.5V I _{OL} = 1mA			0.2	V
V _{OH2}	Output High Voltage	1.8V ≤ V _{CC} < 4.5V I _{OH} = -100μA	V _{CC} - 0.2			V

Note:

- (1) The minimum DC input voltage is -0.5V. During transitions, inputs may undershoot to -2.0V for periods of less than 20 ns. Maximum DC voltage on output pins is V_{CC} +0.5V, which may overshoot to V_{CC} +2.0V for periods of less than 20 ns.
- (2) Output shorted for no more than one second. No more than one output shorted at a time.
- (3) This parameter is tested initially and after a design or process change that affects the parameter.
- (4) Latch-up protection is provided for stresses up to 100 mA on address and data pins from -1V to V_{CC} +1V.

PIN CAPACITANCE

Symbol	Test	Conditions	Min	Typ	Max	Units
C _{OUT} ⁽¹⁾	Output Capacitance (DO)	V _{OUT} =0V			5	pF
C _{IN} ⁽¹⁾	Input Capacitance (CS, SK, DI, ORG)	V _{IN} =0V			5	pF

INSTRUCTION SET

Instruction	Start Bit	Opcode	Address		Data		Comments
			x8	x16	x8	x16	
READ	1	10	A8-A0	A7-A0			Read Address AN– A0
ERASE	1	11	A8-A0	A7-A0			Clear Address AN– A0
WRITE	1	01	A8-A0	A7-A0	D7-D0	D15-D0	Write Address AN– A0
EWEN	1	00	11XXXXXXX	11XXXXXXX			Write Enable
EWDS	1	00	00XXXXXXX	00XXXXXXX			Write Disable
ERAL	1	00	10XXXXXXX	10XXXXXXX			Clear All Addresses
WRAL	1	00	01XXXXXXX	01XXXXXXX	D7-D0	D15-D0	Write All Addresses

A.C. CHARACTERISTICS

Symbol	Parameter	Test Conditions	Limits						Units
			V _{CC} = 1.8V-6V		V _{CC} = 2.5V-6V		V _{CC} = 4.5V-5.5V		
			Min	Max	Min	Max	Min	Max	
t _{CSS}	CS Setup Time		200		100		50		ns
t _{CSH}	CS Hold Time		0		0		0		ns
t _{DIS}	DI Setup Time		400		200		100		ns
t _{DIH}	DI Hold Time		400		200		100		ns
t _{PD1}	Output Delay to 1			1		0.5		0.25	μs
t _{PD0}	Output Delay to 0			1		0.5		0.25	μs
t _{HZ} ⁽¹⁾	Output Delay to High-Z			400		200		100	ns
t _{EW}	Program/Erase Pulse Width			10		10		10	ms
t _{CSSMIN}	Minimum CS Low Time		1		0.5		0.25		μs
t _{SKHI}	Minimum SK High Time		1		0.5		0.25		μs
t _{SKLOW}	Minimum SK Low Time		1		0.5		0.25		μs
t _{SV}	Output Delay to Status Valid			1		0.5		0.25	μs
SK _{MAX}	Maximum Clock Frequency		DC	250	DC	500	DC	1000	kHz

POWER-UP TIMING (1)(2)

Symbol	Parameter	Max	Units
t _{PUR}	Power-up to Read Operation	1	ms
t _{PUW}	Power-up to Write Operation	1	ms

A.C. TEST CONDITIONS

Input Rise and Fall Times	≤ 50ns	
Input Pulse Voltages	0.4V to 2.4V	4.5V ≤ V _{CC} ≤ 5.5V
Timing Reference Voltages	0.8V, 2.0V	4.5V ≤ V _{CC} ≤ 5.5V
Input Pulse Voltages	0.2V _{CC} to 0.7V _{CC}	1.8V ≤ V _{CC} ≤ 4.5V
Timing Reference Voltages	0.5V _{CC}	1.8V ≤ V _{CC} ≤ 4.5V

NOTE:

- (1) This parameter is tested initially and after a design or process change that affects the parameter.
- (2) t_{PUR} and t_{PUW} are the delays required from the time V_{CC} is stable until the specified operation can be initiated.
- (3) The input levels and timing reference points are shown in “AC Test Conditions” table.

DEVICE OPERATION

The CAT93C66 is a 4096-bit nonvolatile memory intended for use with industry standard microprocessors. The CAT93C66 can be organized as either registers of 16 bits or 8 bits. When organized as X16, seven 11-bit instructions control the reading, writing and erase operations of the device. When organized as X8, seven 12-bit instructions control the reading, writing and erase operations of the device. The CAT93C66 operates on a single power supply and will generate on chip, the high voltage required during any write operation.

Instructions, addresses, and write data are clocked into the DI pin on the rising edge of the clock (SK). The DO pin is normally in a high impedance state except when reading data from the device, or when checking the ready/busy status after a write operation.

The ready/busy status can be determined after the start of a write operation by selecting the device (CS high) and polling the DO pin; DO low indicates that the write operation is not completed, while DO high indicates that the device is ready for the next instruction. If necessary, the DO pin may be placed back into a high impedance state during chip select by shifting a dummy “1” into the DI pin. The DO pin will enter the high impedance state on the falling edge of the clock (SK). Placing the DO pin into the high impedance state is recommended in applications where the DI pin and the DO pin are to be tied together to form a common DI/O pin.

The format for all instructions sent to the device is a logical “1” start bit, a 2-bit (or 4-bit) opcode, 8-bit address (an additional bit when organized X8) and for write operations a 16-bit data field (8-bit for X8 organizations).

Read

Upon receiving a READ command and an address (clocked into the DI pin), the DO pin of the CAT93C66 will come out of the high impedance state and, after sending an initial dummy zero bit, will begin shifting out the data addressed (MSB first). The output data bits will toggle on the rising edge of the SK clock and are stable after the specified time delay (t_{PD0} or t_{PD1}).

For the CAT93C66, after the initial data word has been shifted out and CS remains asserted with the SK clock continuing to toggle, the device will automatically increment to the next address and shift out the next data word in a sequential READ mode. As long as CS is continuously asserted and SK continues to toggle, the device will keep incrementing to the next address automatically until it reaches to the end of the address space, then loops back to address 0. In the sequential READ mode, only the initial data word is preceded by a dummy zero bit. All subsequent data words will follow without a dummy zero bit.

Write

After receiving a WRITE command, address and the data, the CS (Chip Select) pin must be deselected for a minimum of t_{CSMIN}. The falling edge of CS will start the self clocking clear and data store cycle of the memory location specified in the instruction. The clocking of the SK pin is not necessary after the device has entered the self clocking mode. The ready/busy status of the CAT93C66 can be determined by selecting the device and polling the DO pin. Since this device features Auto-Clear before write, it is NOT necessary to erase a memory location before it is written into.

Erase

Upon receiving an ERASE command and address, the CS (Chip Select) pin must be deasserted for a minimum of t_{CSMIN} . The falling edge of CS will start the self clocking clear cycle of the selected memory location. The clocking of the SK pin is not necessary after the device has entered the self clocking mode. The ready/busy status of the CAT93C66 can be determined by selecting the device and polling the DO pin. Once cleared, the content of a cleared location returns to a logical "1" state.

Erase/Write Enable and Disable

The CAT93C66 powers up in the write disable state. Any writing after power-up or after an EWDS (write disable) instruction must first be preceded by the EWEN (write enable) instruction. Once the write instruction is enabled, it will remain enabled until power to the device is removed, or the EWDS instruction is sent. The EWDS instruction can be used to disable all CAT93C66 write and clear instructions, and will prevent any accidental writing or clearing of the device. Data can be read normally from the device regardless of the write enable/disable status.

Erase All

Upon receiving an ERAL command, the CS (Chip Select) pin must be deselected for a minimum of t_{CSMIN} . The falling edge of CS will start the self clocking clear cycle of all memory locations in the device. The clocking of the SK pin is not necessary after the device has entered the self clocking mode. The ready/busy status of the CAT93C66 can be determined by selecting the device and polling the DO pin. Once cleared, the contents of all memory bits return to a logical "1" state.

Write All

Upon receiving a WRAL command and data, the CS (Chip Select) pin must be deselected for a minimum of t_{CSMIN} . The falling edge of CS will start the self clocking data write to all memory locations in the device. The clocking of the SK pin is not necessary after the device has entered the self clocking mode. The ready/busy status of the CAT93C66 can be determined by selecting the device and polling the DO pin. It is not necessary for all memory locations to be cleared before the WRAL command is executed.

Figure 4. Erase Instruction Timing

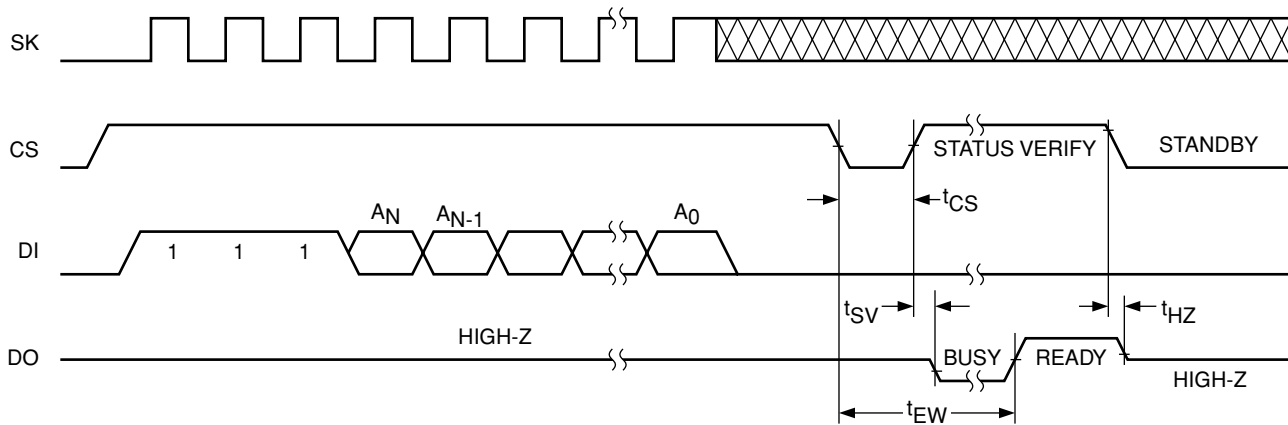

Figure 5. EWEN/EWDS Instruction Timing

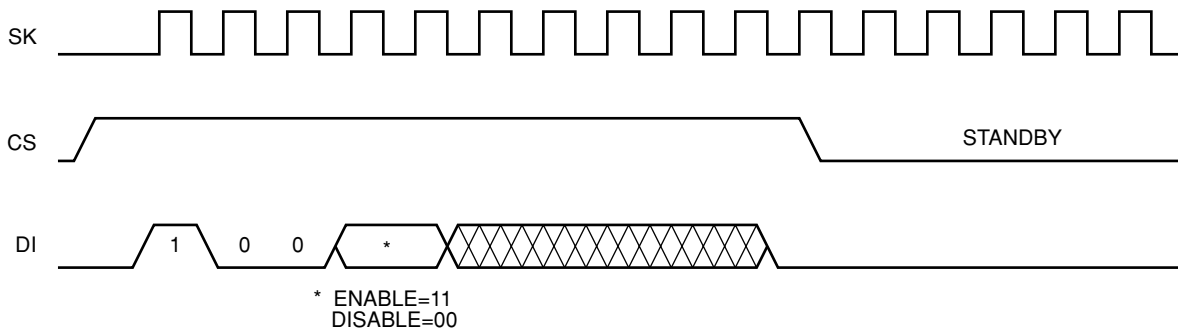

Figure 6. ERAL Instruction Timing

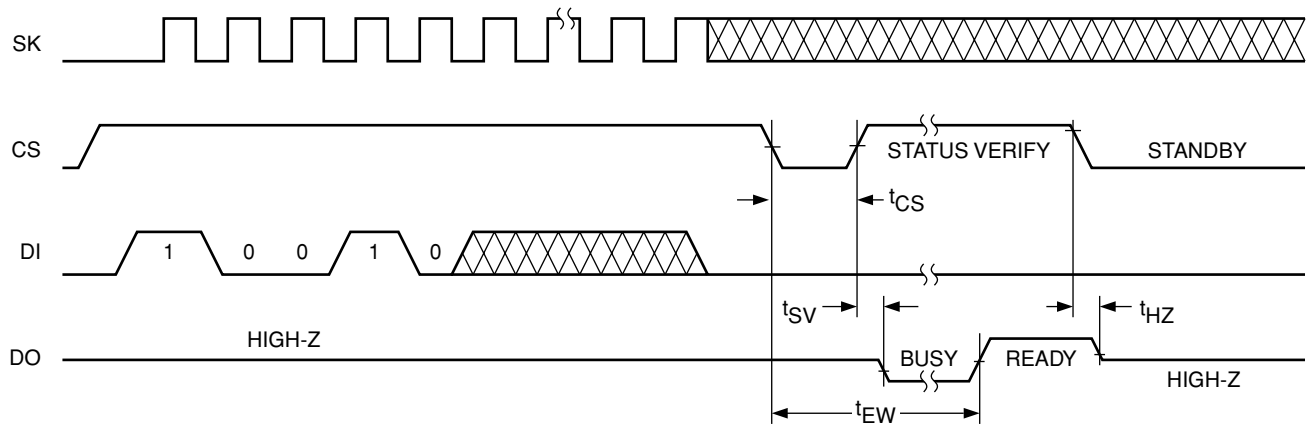
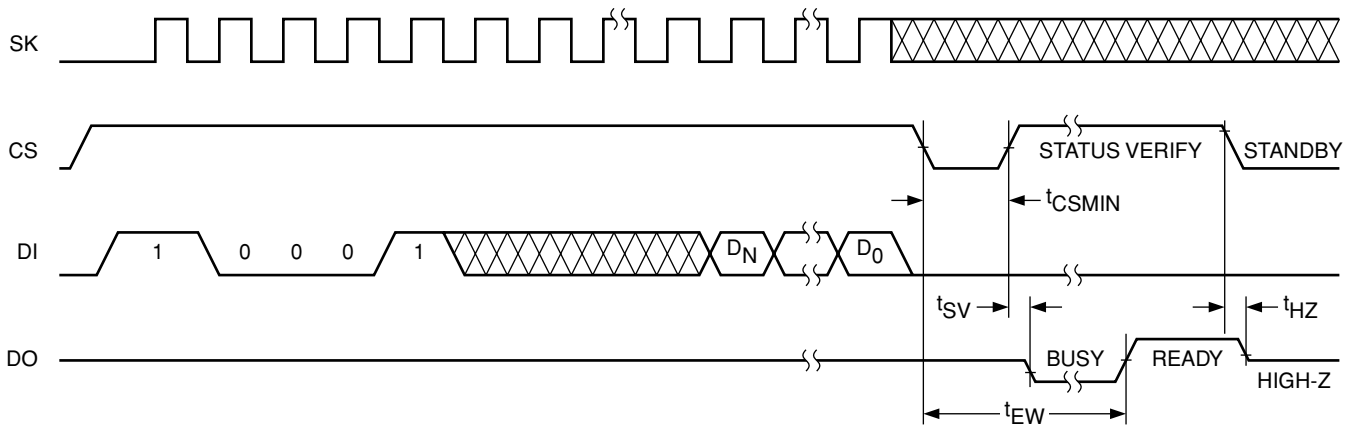
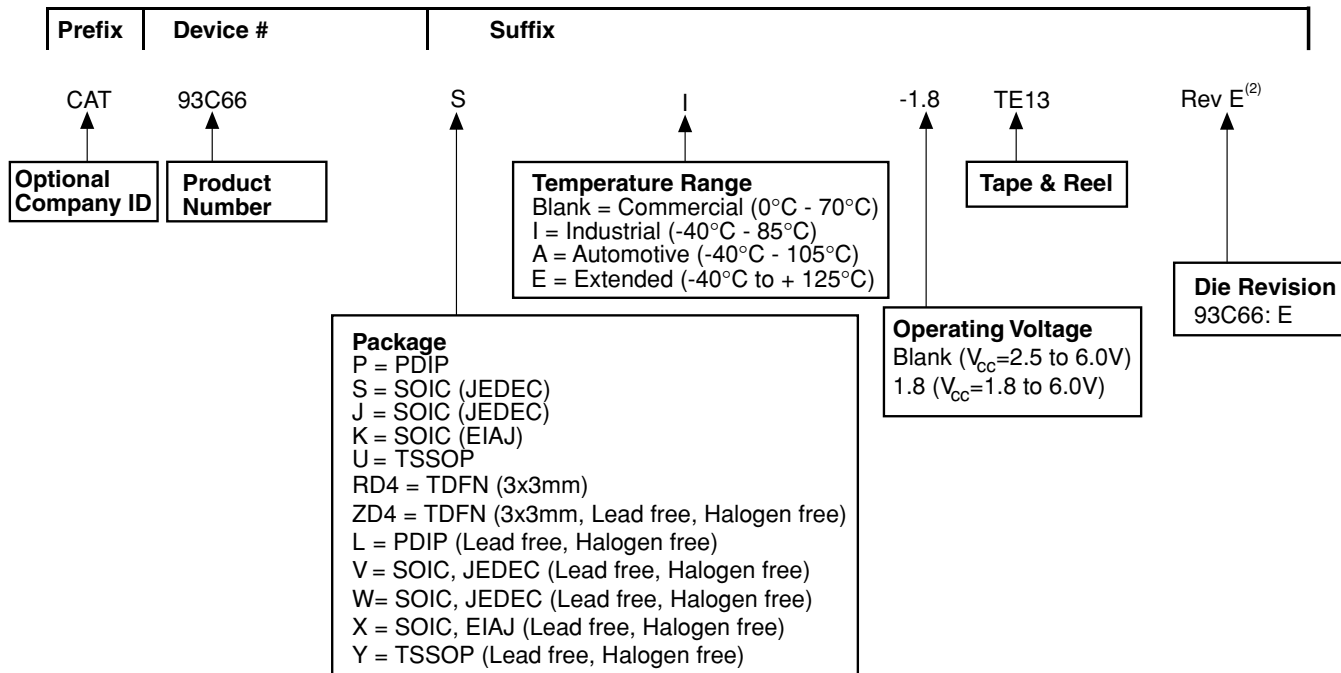

Figure 7. WRAL Instruction Timing



ORDERING INFORMATION



Notes:

- (1) The device used in the above example is a 93C66SI-1.8TE13 (SOIC, Industrial Temperature, 1.8 Volt to 6 Volt Operating Voltage, Tape & Reel)
- (2) Product die revision letter is marked on top of the package as a suffix to the production date code (e.g., AYWWE.) For additional information, please contact your Catalyst sales office.

REVISION HISTORY

Date	Revision	Comments
05/14/04	L	New Data Sheet Created From CAT93C46/56/57/66/86. Parts CAT93C56, CAT93C56, CAT93C57, CAT93C66, CAT93C76 and CAT93C86 have been separated into single data sheets Add Die Revision ID Letter Update Features Update Description Update Pin Condition Add Functional Diagram Update Pin Function Update D.C. Operating Characteristics Update Pin Capacitance Update Instruction Set Update Device Operation Update Ordering Information Update Revision History Update Rev Number

Copyrights, Trademarks and Patents

Trademarks and registered trademarks of Catalyst Semiconductor include each of the following:

DPP™ AE²™

Catalyst Semiconductor has been issued U.S. and foreign patents and has patent applications pending that protect its products. For a complete list of patents issued to Catalyst Semiconductor contact the Company's corporate office at 408.542.1000.

CATALYST SEMICONDUCTOR MAKES NO WARRANTY, REPRESENTATION OR GUARANTEE, EXPRESS OR IMPLIED, REGARDING THE SUITABILITY OF ITS PRODUCTS FOR ANY PARTICULAR PURPOSE, NOR THAT THE USE OF ITS PRODUCTS WILL NOT INFRINGE ITS INTELLECTUAL PROPERTY RIGHTS OR THE RIGHTS OF THIRD PARTIES WITH RESPECT TO ANY PARTICULAR USE OR APPLICATION AND SPECIFICALLY DISCLAIMS ANY AND ALL LIABILITY ARISING OUT OF ANY SUCH USE OR APPLICATION, INCLUDING BUT NOT LIMITED TO, CONSEQUENTIAL OR INCIDENTAL DAMAGES.

Catalyst Semiconductor products are not designed, intended, or authorized for use as components in systems intended for surgical implant into the body, or other applications intended to support or sustain life, or for any other application in which the failure of the Catalyst Semiconductor product could create a situation where personal injury or death may occur.

Catalyst Semiconductor reserves the right to make changes to or discontinue any product or service described herein without notice. Products with data sheets labeled "Advance Information" or "Preliminary" and other products described herein may not be in production or offered for sale.

Catalyst Semiconductor advises customers to obtain the current version of the relevant product information before placing orders. Circuit diagrams illustrate typical semiconductor applications and may not be complete.



CATALYST

Catalyst Semiconductor, Inc.

Corporate Headquarters

1250 Borregas Avenue

Sunnyvale, CA 94089

Phone: 408.542.1000

Fax: 408.542.1200

www.catalyst-semiconductor.com

Publication #: 1089

Revision: L

Issue date: 5/14/04