

Turbo 2 ultrafast high voltage rectifier

Datasheet - production data

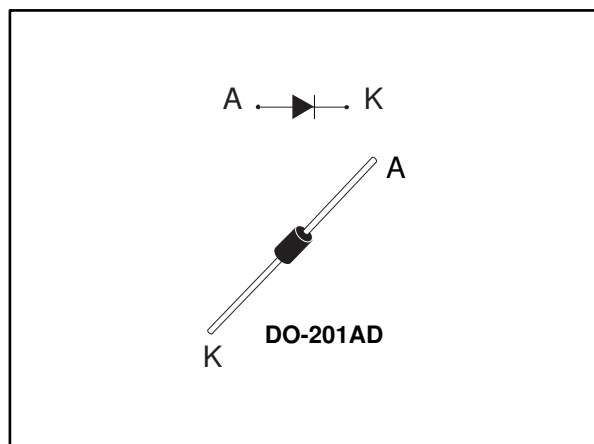

Features

- Ultrafast switching
- Low forward voltage drop
- Low leakage current (platinum doping)
- High operating junction temperature

Description

This device uses ST Turbo 2 600 V technology and is specially suited for use as a boost diode in discontinuous or critical mode power factor correction.

Packaged in DO-201AD it is ideal for use as freewheeling diode in power supplies and other power switching applications.

Table 1: Device summary

Symbol	Value
$I_{F(AV)}$	4 A
V_{RRM}	600 V
T_j (max.)	175 °C
V_F (typ.)	0.9 V
t_{rr} (typ.)	40 ns

1 Characteristics

Table 2: Absolute ratings (limiting values, per diode)

Symbol	Parameter	Value	Unit
V_{RRM}	Repetitive peak reverse voltage	600	V
$I_{F(RMS)}$	Forward rms current	10	A
$I_{F(AV)}$	Average forward current	4	A
I_{FSM}	Surge non repetitive forward current	$t_p = 8.3$ ms sinusoidal	80 A
T_{stg}	Storage temperature range	-65 to +175	°C
T_j	Maximum operating junction temperature	175	°C

Table 3: Thermal parameters

Symbol	Parameter	Maximum values	Unit
$R_{th(j-l)}$	Junction to lead	20	°C/W
$R_{th(j-a)}$	Junction to ambient		
Terminal length = 10 mm		75	

Table 4: Static electrical characteristics

Symbol	Parameter	Test conditions	Min.	Typ.	Max.	Unit	
$I_R^{(1)}$	Reverse leakage current	$T_j = 25$ °C	$V_R = V_{RRM}$	-	-	3	μA
		$T_j = 150$ °C		-	15	100	
$V_F^{(2)}$	Forward voltage drop	$T_j = 25$ °C	$I_F = 3$ A	-		1.30	V
		$T_j = 150$ °C		-	0.85	1.05	
		$T_j = 150$ °C	$I_F = 4$ A	-	0.90	1.10	

Notes:

(1) Pulse test: $t_p = 5$ ms, $\delta < 2\%$

(2) Pulse test: $t_p = 380$ μs, $\delta < 2\%$

To evaluate the maximum conduction losses, use the following equation:

$$P = 0.92 \times I_{F(AV)} + 0.0045 \times I_{F(RMS)}^2$$

Table 5: Dynamic characteristics (per diode)

Symbol	Parameter	Test conditions		Min.	Typ.	Max.	Unit
t_{rr}	Reverse recovery time		$I_F = 1\text{ A}$, $di_F/dt = -50\text{ A}/\mu\text{s}$, $V_R = 30\text{ V}$	-	55	75	ns
			$I_F = 1\text{ A}$, $di_F/dt = -100\text{ A}/\mu\text{s}$, $V_R = 30\text{ V}$	-	40	55	
I_{RM}	Reverse recovery current	$T_j = 25\text{ °C}$	$I_F = 4\text{ A}$, $di_F/dt = -100\text{ A}/\mu\text{s}$, $V_R = 400\text{ V}$	-	3	4	A
		$T_j = 150\text{ °C}$		-	5	6.5	
t_{fr}	Forward recovery time		$I_F = 4\text{ A}$, $di_F/dt = -100\text{ A}/\mu\text{s}$, $V_{FR} = 1.1 \times V_{Fmax}$	-		130	ns
V_{FP}	Forward recovery voltage		$I_F = 4\text{ A}$, $di_F/dt = 100\text{ A}/\mu\text{s}$	-		7.5	V

1.1 Characteristics (curves)

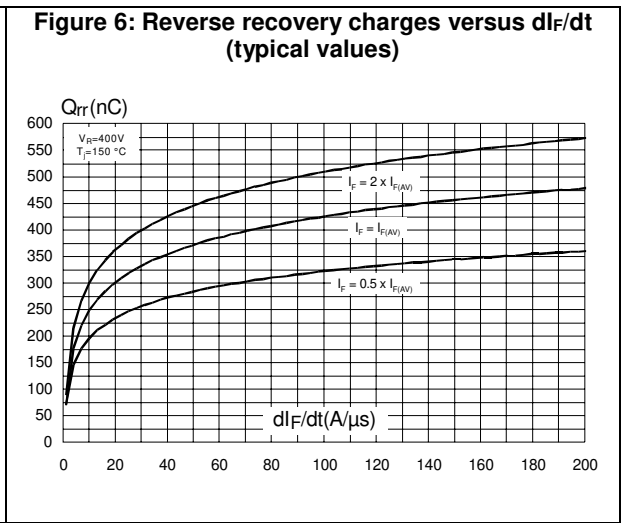
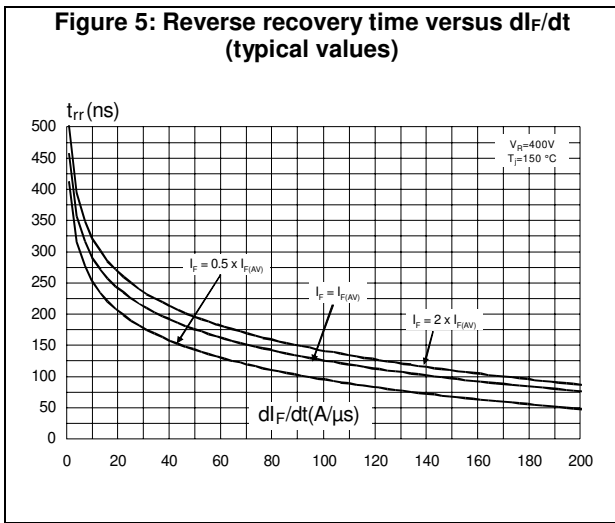
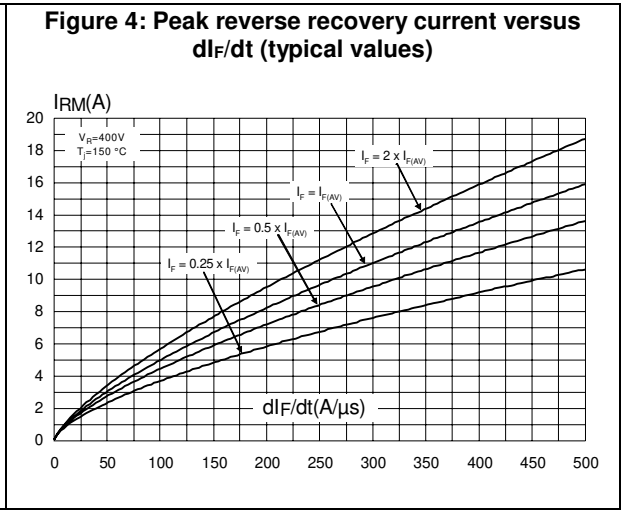
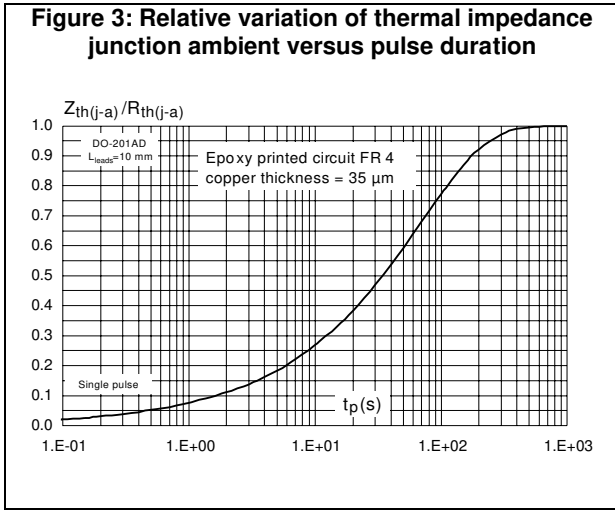
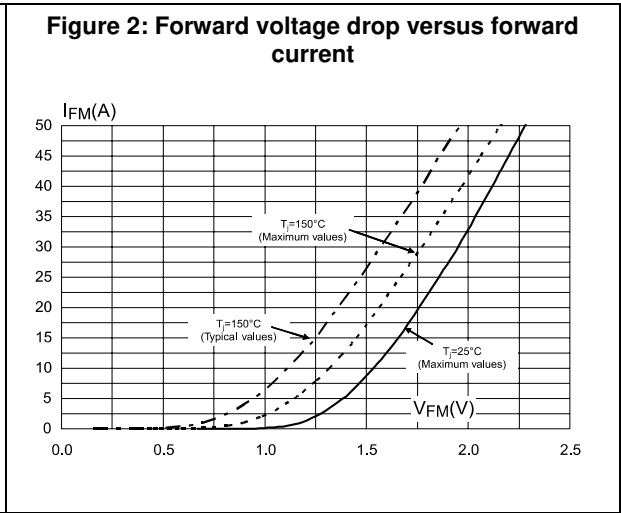
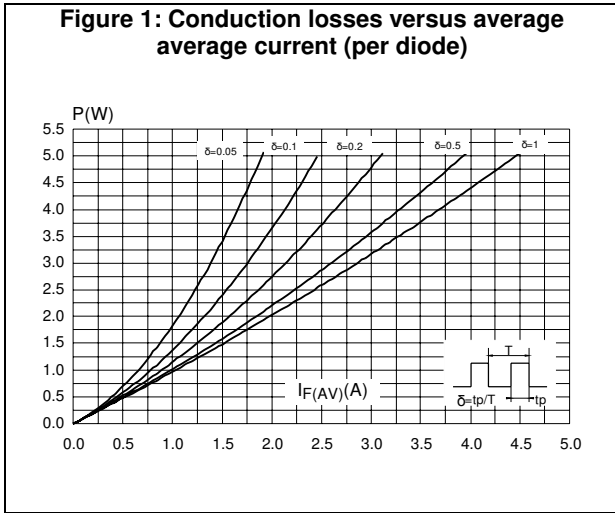

Figure 7: Relative variations of dynamic parameters versus junction temperature

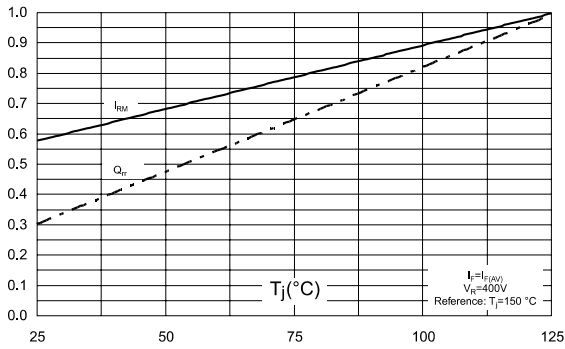

Figure 8: Transient peak forward voltage versus di_F/dt (typical values)

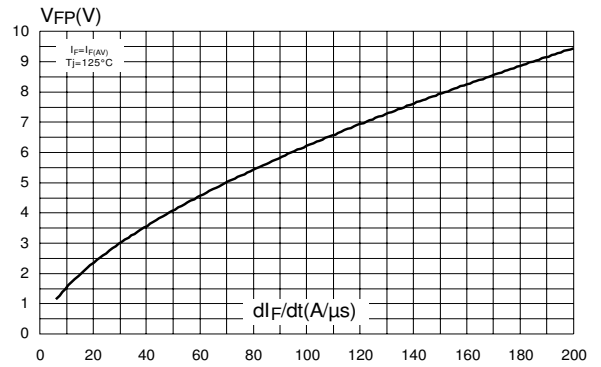

Figure 9: Forward recovery time versus di_F/dt (typical values)

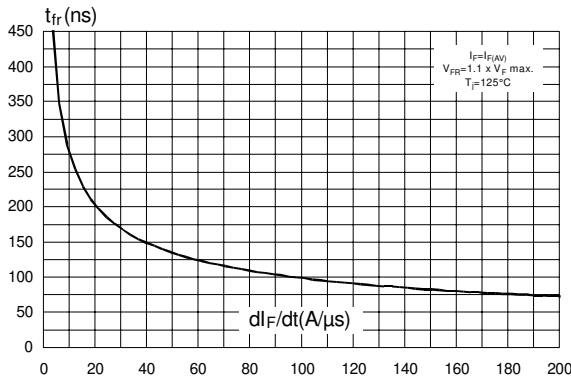

Figure 10: Junction capacitance versus reverse voltage applied (typical values)

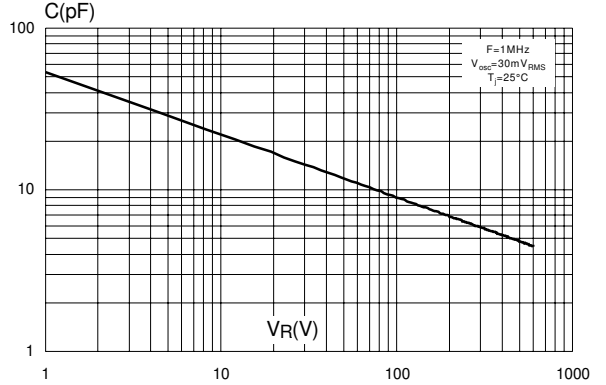

Figure 11: Thermal resistance junction to ambient versus copper surface under lead

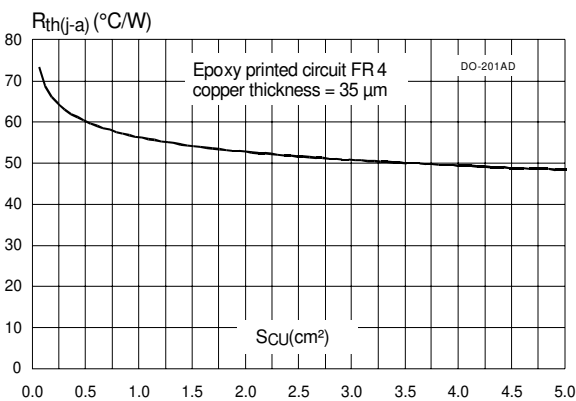
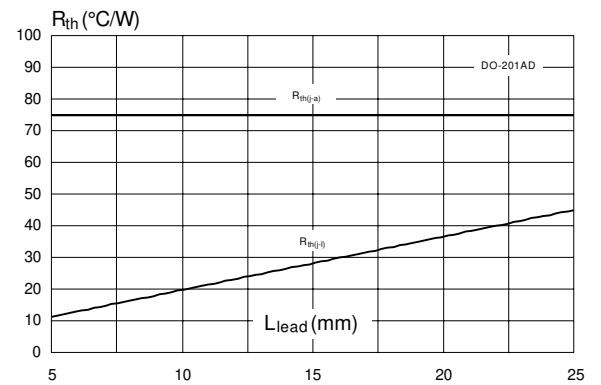

Figure 12: Thermal resistance versus lead length



2 Package information

In order to meet environmental requirements, ST offers these devices in different grades of ECOPACK® packages, depending on their level of environmental compliance. ECOPACK® specifications, grade definitions and product status are available at: www.st.com. ECOPACK® is an ST trademark.

- Epoxy meets UL94, V0
- Band indicated cathode (DO-201AD)
- Bending method: see application note AN1471 (DO-201AD)

2.1 DO-201AD package information

Figure 13: DO-201AD package outline

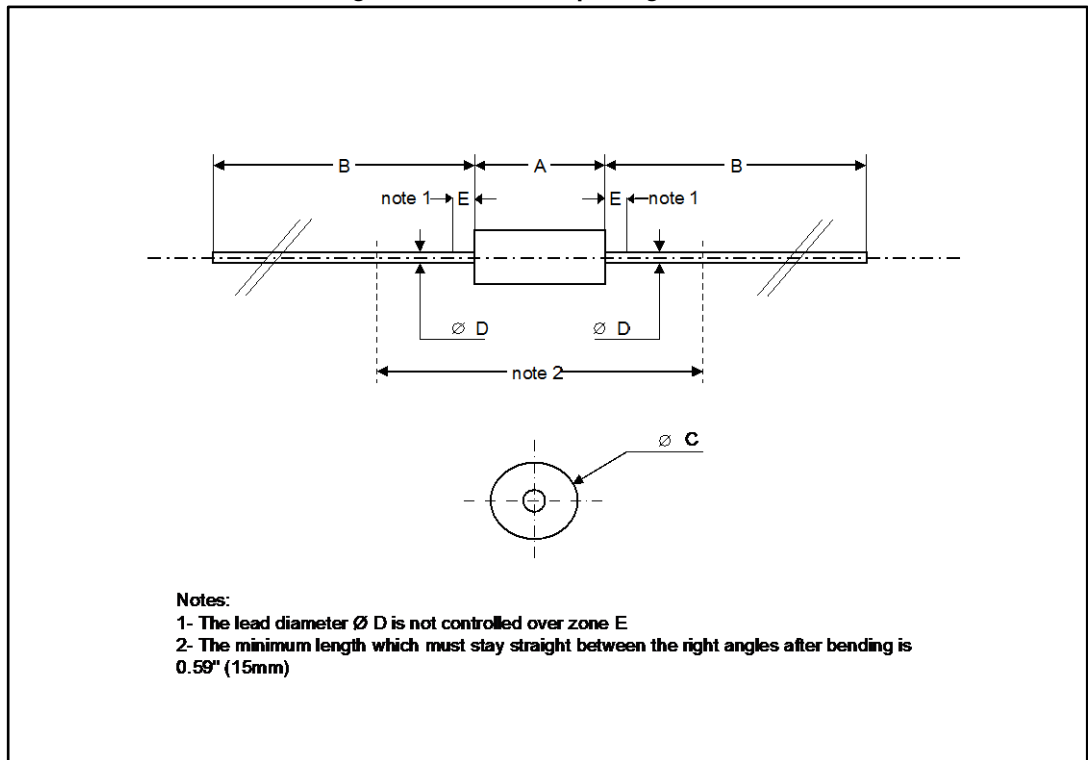

Table 6: DO-201AD package mechanical data

Ref.	Dimensions			
	Millimeters		Inches	
	Min.	Max.	Min.	Max.
A		9.5		0.3740
B	25.4		1.000	
C		5.3		0.2087
D		1.3		0.0512
E		1.25		0.0492

3 Ordering information

Table 7: Ordering information

Order code	Marking	Package	Weight	Base qty.	Delivery mode
STTH4L06	STTH4L06	DO-201AD	1.16 g	600	Ammopack
STTH4L06RL	STTH4L06			1900	Tape and reel

4 Revision history

Table 8: Document revision history

Date	Revision	Changes
22-Sep-2009	1	First issue.
27-Jan-2017	2	Removed DO-15 package.

IMPORTANT NOTICE – PLEASE READ CAREFULLY

STMicroelectronics NV and its subsidiaries ("ST") reserve the right to make changes, corrections, enhancements, modifications, and improvements to ST products and/or to this document at any time without notice. Purchasers should obtain the latest relevant information on ST products before placing orders. ST products are sold pursuant to ST's terms and conditions of sale in place at the time of order acknowledgement.

Purchasers are solely responsible for the choice, selection, and use of ST products and ST assumes no liability for application assistance or the design of Purchasers' products.

No license, express or implied, to any intellectual property right is granted by ST herein.

Resale of ST products with provisions different from the information set forth herein shall void any warranty granted by ST for such product.

ST and the ST logo are trademarks of ST. All other product or service names are the property of their respective owners.

Information in this document supersedes and replaces information previously supplied in any prior versions of this document.

© 2017 STMicroelectronics – All rights reserved