



Part Number: D3I0802S

Electrical Specifications

Frequency Range (GHz):	0.8 – 2.0
Isolation (dB):	14 MIN
Insertion Loss (dB):	1.0 MAX
VSWR:	1.5:1 MIN
Forward Power (W):	50 AVG 75 PK
Reflective Power (W):	10 AVG

Mechanical/Environmental Specifications

Connector Type:	SMA
Connector Body:	Nickel plated brass
Connector Pin:	Gold plated copper
Load Body:	Brass
Magnetic Shunt:	Nickel plated CRS
Operational Temp:	10°C to +55°C
Weight (oz)	15 MAX

D3I0802S Dimensions

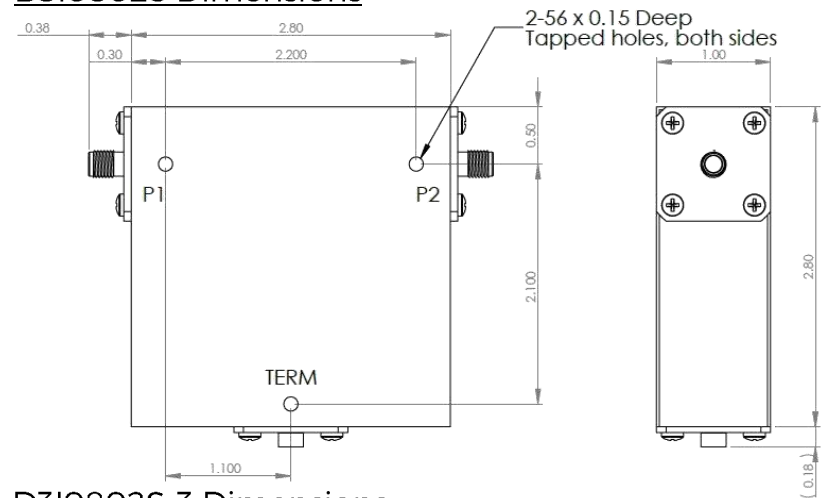

D3I0802S-3 Dimensions

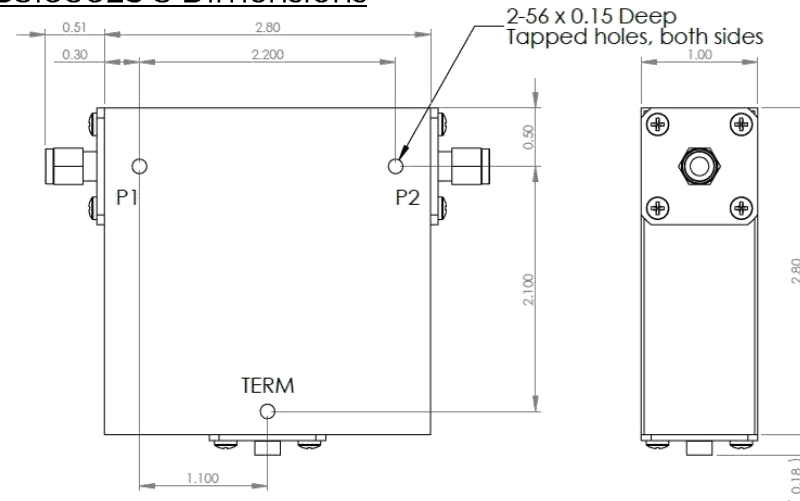

Dimensions are in inches
Tolerance

XX	±0.03
XXX	±0.010

Type of Device	PN Suffix	Connector Configuration Input / Output	PN Example
Single and Dual Junction Isolator, 2-Port Device Input / Output	N/A	Female / Female	D3I0802S
	-1	Male / Female	D3I0802S-1
	-2	Female / Male	D3I0802S-2
	-3	Male / Male	D3I0802S-3





MEASURED DATA

Part Number: D3I0802S, +25°C

