

Low Profile Shielded SMD Chip Power Inductor

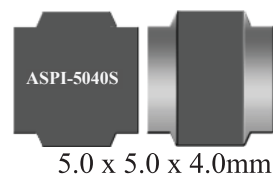

ASPI-5040S



RoHS
Compliant

FEATURES:

- Magnetically shielded for low radiation
- Large Terminal surface for good PCB mounting
- Low DCR and high rated current
- Suitable for DC-DC converter applications

APPLICATIONS:

- Portable communication equipment
- OA equipment
- LCD, DVD, modem, set-top box
- DC/DC converters

ELECTRICAL SPECIFICATIONS:

Part Number	Inductance	Tolerance	DCR Max	DCR Typ	Current Max	Temperature Rise Current Max
Units	μH	%	$\text{m}\Omega$	$\text{m}\Omega$	A	A
Symbol	L	M=±20%, N=±30%	DCR	DCR	Isat	Irms
ASPI-5040S-1R5	1.5	N	24	20	6.00	3.60
ASPI-5040S-2R2	2.2	N	26	22	4.60	3.50
ASPI-5040S-3R3	3.3	N	32	27	3.80	3.30
ASPI-5040S-4R7	4.7	N	35	29	3.30	3.10
ASPI-5040S-6R8	6.8	M	59	49	2.60	2.30
ASPI-5040S-100	10	M	67	56	2.30	2.10
ASPI-5040S-150	15	M	96	80	2.00	1.80
ASPI-5040S-220	22	M	151	126	1.60	1.40
ASPI-5040S-330	33	M	216	180	1.30	1.20
ASPI-5040S-470	47	M	372	310	1.10	0.90

Test Criteria:

Inductance: 100kHz, 1V

Isat: Based on inductance change ($\Delta L/L_0: \leq -30\%$)

Irms: Based on temperature rise ($\Delta T: 40^\circ\text{C TYP.}$)

Storage Temperature $-40^\circ\text{C} \sim 125^\circ\text{C}$ (including self-generated heat)

Operating Temperature $-40^\circ\text{C} \sim 125^\circ\text{C}$

OPTIONS AND PART IDENTIFICATION

ASPI-5040S - [] [] - []

Inductance Code
Please refer to the table above

Tolerance
M: ±20%
N: ±30%

Packaging
T: Tape and Reel
(1.5kpcs / reel)

M for 6.8 μH ~47 μH
N for 1.5 μH ~4.7 μH

Low Profile Shielded SMD Chip Power Inductor

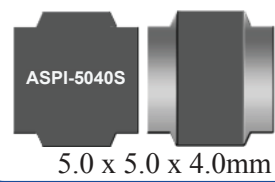

ASPI-5040S



RoHS
Compliant

5.0 x 5.0 x 4.0mm

OUTLINE DRAWING:

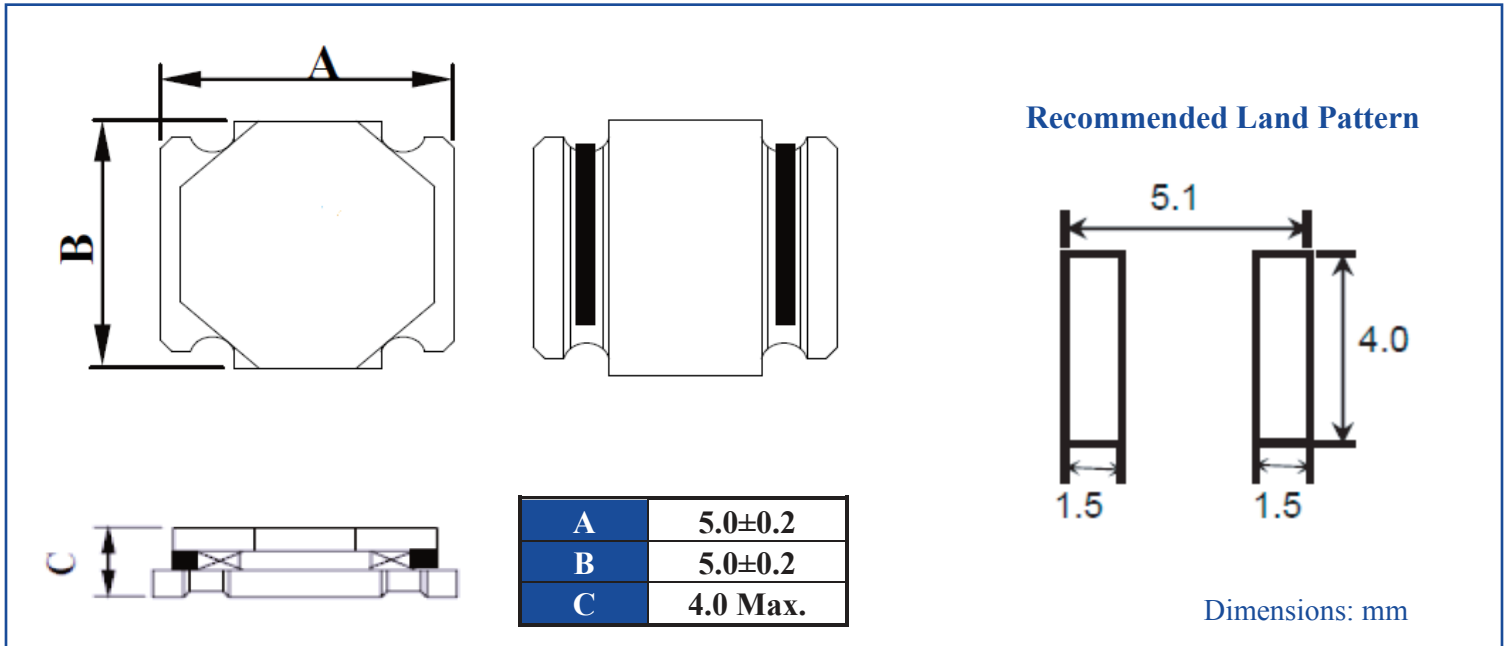

REFLOW PROFILE

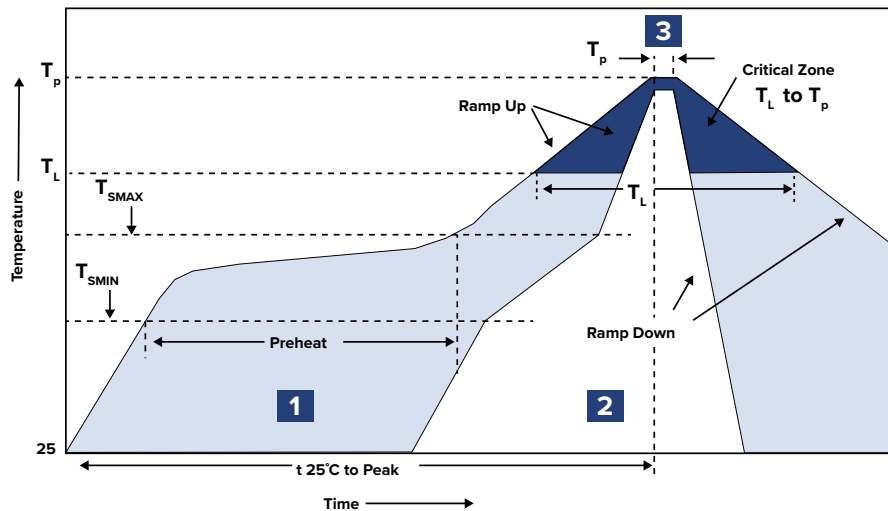

Zone	Description	Temperature	Time
1	Preheat / Soak	T_{SMAX} 150°C	60 sec.
2	Reflow	T_L 200°C	20 sec. MAX
3	Peak heat	T_P 260°C	10 sec. MAX

Low Profile Shielded SMD Chip Power Inductor

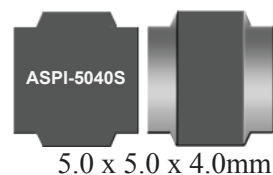

ASPI-5040S



RoHS
Compliant

5.0 x 5.0 x 4.0mm

TAPE & REEL: T: 1500pcs/reel

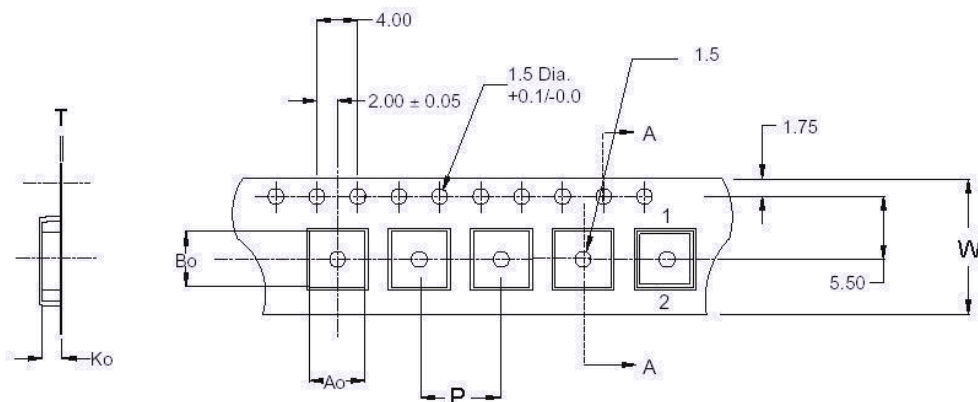

Ao	5.40
Bo	5.40
Ko	4.75
W	16.00
P	12.00
T	0.35

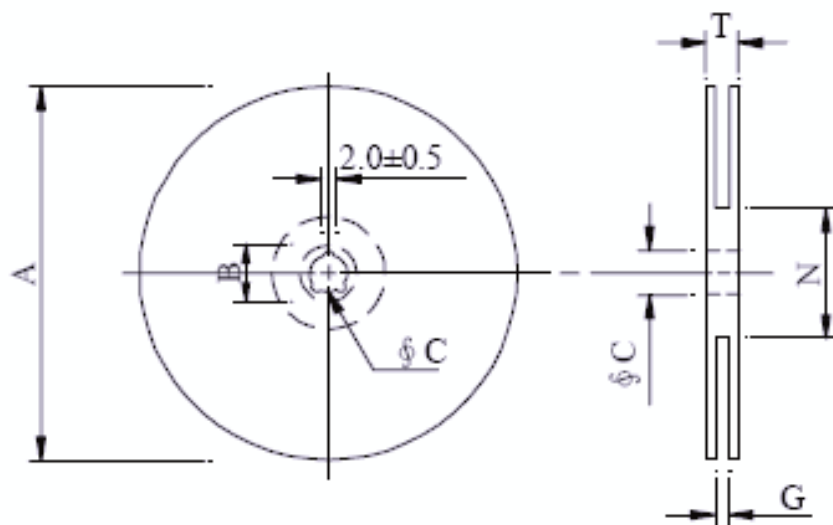

A	330
B	21.0±0.8
C	13.5±0.5
G	16.8
N	99.5
T	21.0

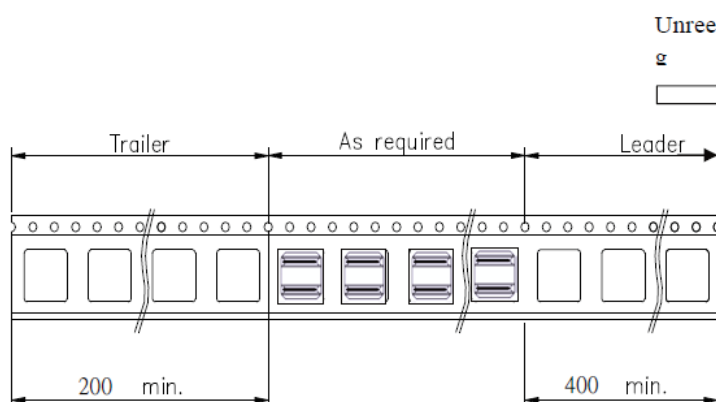

Dimensions: mm

ATTENTION: Abracon LLC's products are COTS – Commercial-Off-The-Shelf products; suitable for Commercial, Industrial and, where designated, Automotive Applications. Abracon's products are not specifically designed for Military, Aviation, Aerospace, Life-dependent Medical applications or any application requiring high reliability where component failure could result in loss of life and/or property. For applications requiring high reliability and/or presenting an extreme operating environment, written consent and authorization from Abracon LLC is required. Please contact Abracon LLC for more information.



5101 Hidden Creek Ln Spicewood TX 78669
Phone: 512-371-6159 | Fax: 512-351-8858
For terms and conditions of sales, please visit:
www.abracon.com

REVISED: 12-02-19

ABRACON IS
ISO9001-2015
CERTIFIED