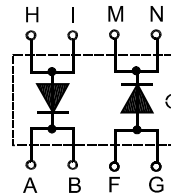

# Fast Recovery Epitaxial Diode (FRED)

$I_{FAVM} = 2x30 \text{ A}$   
 $V_{RRM} = 600 \text{ V}$   
 $t_{rr} = 35 \text{ ns}$

$V_{RSM}$	$V_{RRM}$	Type
V	V	
600	600	DSEI 2x 30-06P

**D5**

Symbol	Conditions	Maximum Ratings (per diode)	
$I_{FRMS}$	$T_{VJ} = T_{VJM}$	70	A
$I_{FAVM}$ ①	$T_C = 85^\circ\text{C}$ ; rectangular; $d = 0.5$	30	A
$I_{FRM}$	$t_p < 10 \mu\text{s}$ ; rep. rating; pulse width limited by $T_{VJM}$	375	A
$I_{FSM}$	$T_{VJ} = 45^\circ\text{C}$ ; $t = 10 \text{ ms}$ (50 Hz), sine	300	A
$T_{VJ}$		-40...+150	$^\circ\text{C}$
$T_{VJM}$		150	$^\circ\text{C}$
$T_{stg}$		-40...+150	$^\circ\text{C}$
$P_{tot}$	$T_C = 25^\circ\text{C}$	100	W
$V_{ISOL}$	50/60 Hz, RMS	$t = 1 \text{ min}$	2500 V~
	$I_{ISOL} \leq 1 \text{ mA}$	$t = 1 \text{ s}$	3000 V~
$M_d$	Mounting torque (M4)	1.5 - 2.0	Nm
		14 - 18	lb.in.
<b>Weight</b>		18	g

### Features

- 2 independent FRED in 1 package
- Isolation voltage 3000 V~
- Planar passivated chips
- Leads suitable for PC board soldering
- Very short recovery time
- Soft recovery behaviour

### Applications

- Antiparallel diode for high frequency switching devices
- Anti saturation diode
- Snubber diode
- Free wheeling diode in converters and motor control circuits
- Rectifiers in switch mode power supplies (SMPS)
- Inductive heating and melting
- Uninterruptible power supplies (UPS)
- Ultrasonic cleaners and welders

### Advantages

- Easy to mount with two screws
- Space and weight savings
- Improved temperature and power cycling capability
- Low noise switching
- Small and light weight

Symbol	Conditions	Characteristic Values (per diode)	
		typ.	max.
$I_R$	$T_{VJ} = 25^\circ\text{C}$ $V_R = V_{RRM}$	100	$\mu\text{A}$
	$T_{VJ} = 25^\circ\text{C}$ $V_R = 0.8 \cdot V_{RRM}$	50	$\mu\text{A}$
	$T_{VJ} = 125^\circ\text{C}$ $V_R = 0.8 \cdot V_{RRM}$	7	mA
$V_F$	$I_F = 30 \text{ A}$ ; $T_{VJ} = 150^\circ\text{C}$	1.4	V
	$T_{VJ} = 25^\circ\text{C}$	1.6	V
$V_{T0}$	For power-loss calculations only	1.01	V
$r_T$	$T_{VJ} = T_{VJM}$	7.1	m $\Omega$
$R_{thJC}$		1.25	K/W
$R_{thCK}$	0.05		K/W
$t_{rr}$	$I_F = 1 \text{ A}$ ; $-di/dt = 100 \text{ A}/\mu\text{s}$	35	ns
	$V_R = 30 \text{ V}$ ; $T_{VJ} = 25^\circ\text{C}$		
$I_{RM}$	$V_R = 350 \text{ V}$ ; $I_F = 30 \text{ A}$ ; $-di_F/dt = 240 \text{ A}/\mu\text{s}$ $L \leq 0.05 \mu\text{H}$ ; $T_{VJ} = 100^\circ\text{C}$	10	11 A
$d_S$	Creeping distance on surface	min. 11.2	mm
$d_A$	Creeping distance in air	min. 11.2	mm
$a$	Allowable acceleration	max. 50	m/s <sup>2</sup>

**Recommended replacement:  
DSEI 2x31-06P, DSEI 2x31-06C**

①  $I_{FAVM}$  rating includes reverse blocking losses at  $T_{VJM}$ ,  $V_R = 0.8 V_{RRM}$ , duty cycle  $d = 0.5$   
Data according to IEC 60747

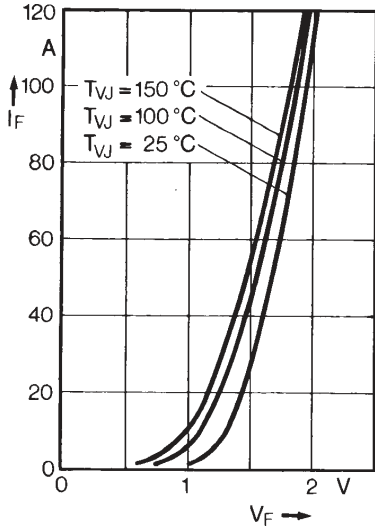

Fig. 1 Forward current versus voltage drop.

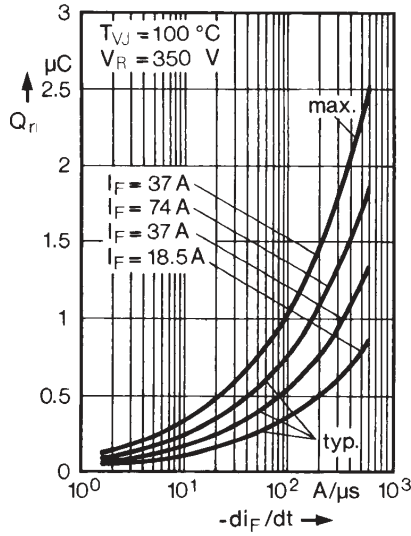

Fig. 2 Recovery charge versus  $-di_F/dt$ .

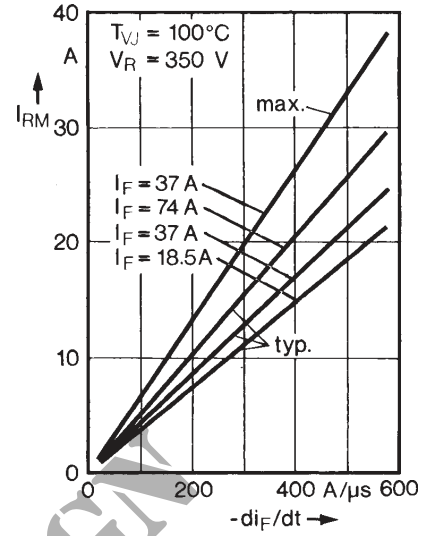

Fig. 3 Peak reverse current versus  $-di_F/dt$ .

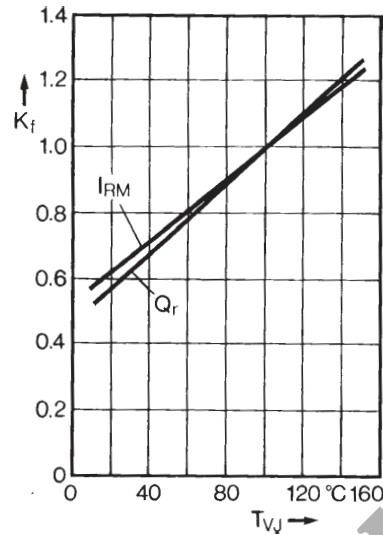

Fig. 4 Dynamic parameters versus junction temperature.

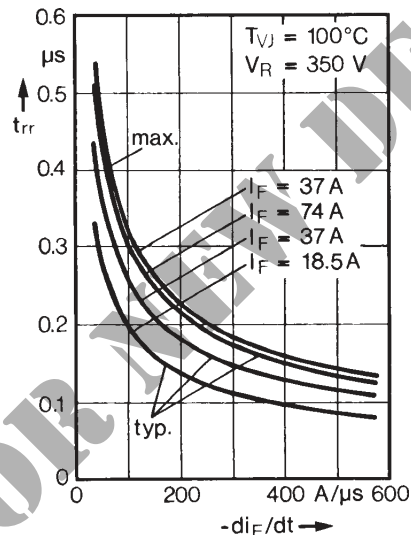

Fig. 5 Recovery time versus  $-di_F/dt$ .

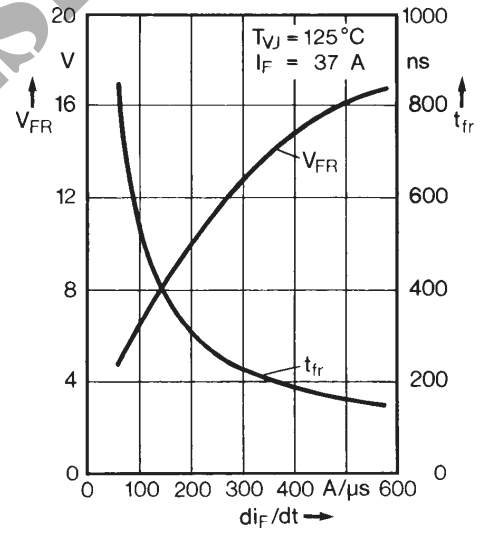

Fig. 6 Peak forward voltage versus  $di_F/dt$ .

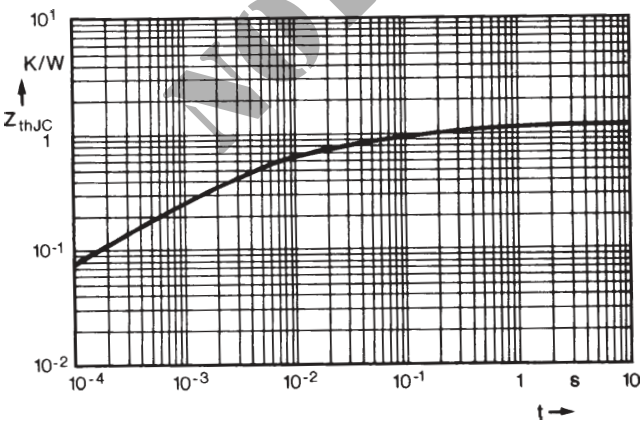
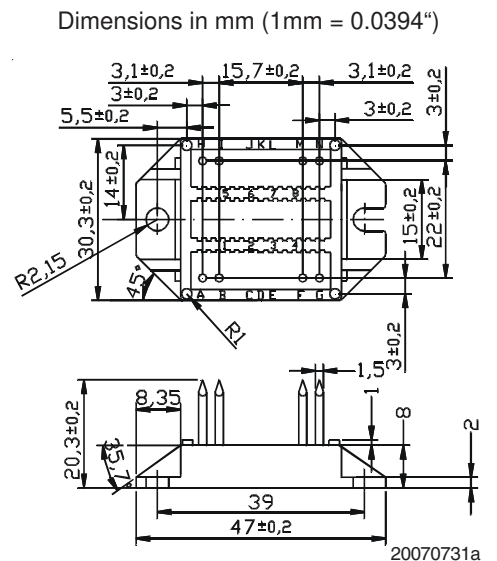

Fig. 7 Transient thermal impedance junction to case.



20070731a