

150 mA - ultra low noise - high PSRR linear voltage regulator IC

Datasheet - production data



Description

The LDLN015 is an ultra low noise linear regulator which provides 150 mA maximum current from an input voltage ranging from 2.1 V to 5.5 V with a typical dropout voltage of 86 mV. With its 6.3 μ V_{RMS} noise value in a band from 10 Hz to 100 kHz, the LDLN015 provides a very clean output suitable for ultra sensitive loads. It is stable with ceramic capacitors. High PSRR, low quiescent current and very low noise features make it suitable for low power battery powered applications. Power supply rejection is higher than 90 dB at low frequencies and starts to roll off at 10 kHz. The enable logic control function puts the LDLN015 into shutdown mode allowing a total current consumption lower than 1 μ A. The device also includes a short-circuit constant current limiting and thermal protection. Typical applications are noise sensitive loads like ADC, VCO in mobile phones, and personal digital assistants (PDAs).

Features

- Ultra low noise: 6.3 μ V_{RMS} from 10 Hz to 100 kHz
- Input voltage from 2.1 to 5.5 V
- Very low quiescent current (35 μ A typ. at no load, 70 μ A typ. at 150 mA load; 2 μ A max. in off mode)
- Output voltage tolerance: \pm 1% at 25 °C
- 150 mA guaranteed output current
- Wide range of output voltage from 0.8 V to 3.3 V with 100 mV step
- Logic-controlled electronic shutdown
- Compatible with ceramic capacitor (C_{OUT} = 0.47 μ F)
- No bypass capacitor is required
- Internal current and thermal limit
- Package DFN6 (2 x 2 mm)
- Temperature range: - 40 °C to 125 °C

Table 1: Device summary

Order code	Output voltage (V)
LDLN015PU10R	1.0
LDLN015PU12R	1.2
LDLN015PU15R	1.5
LDLN015PU18R	1.8
LDLN015PU25R	2.5
LDLN015PU28R	2.8
LDLN015PU30R	3.0
LDLN015PU33R	3.3

Contents

1	Application diagram	3
2	Pin configuration	4
3	Maximum ratings	5
4	Electrical characteristics	6
5	Typical performance characteristics	8
6	Package information	12
	6.1 DFN6 (2 x 2 mm) package information	12
	6.2 DFN6 (2 x 2 mm) packing information.....	14
7	Revision history	15

1 Application diagram

Figure 1: Block diagram

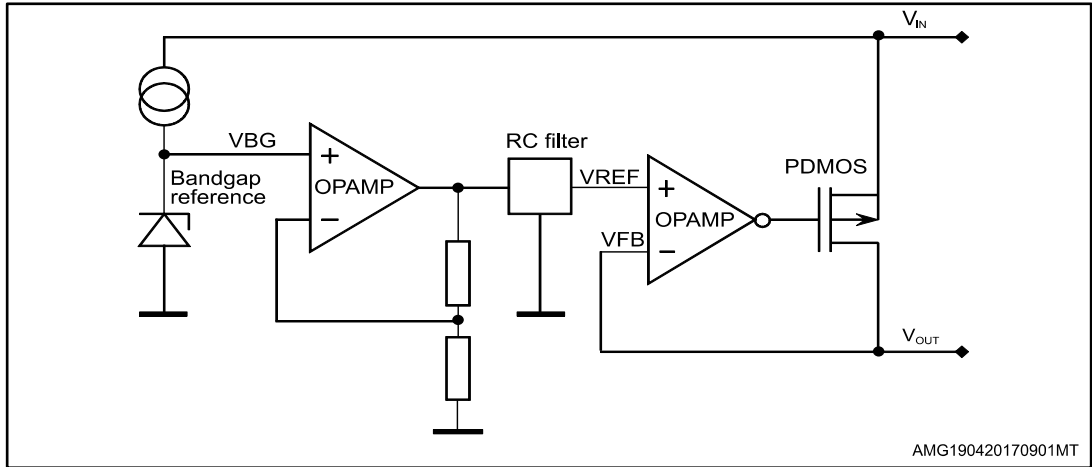
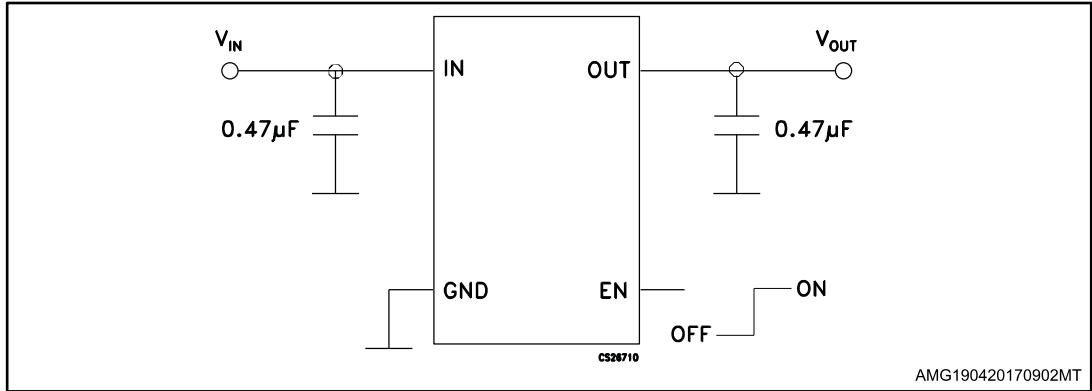

Figure 2: Typical application circuit



2 Pin configuration

Figure 3: Pin connections (top view)

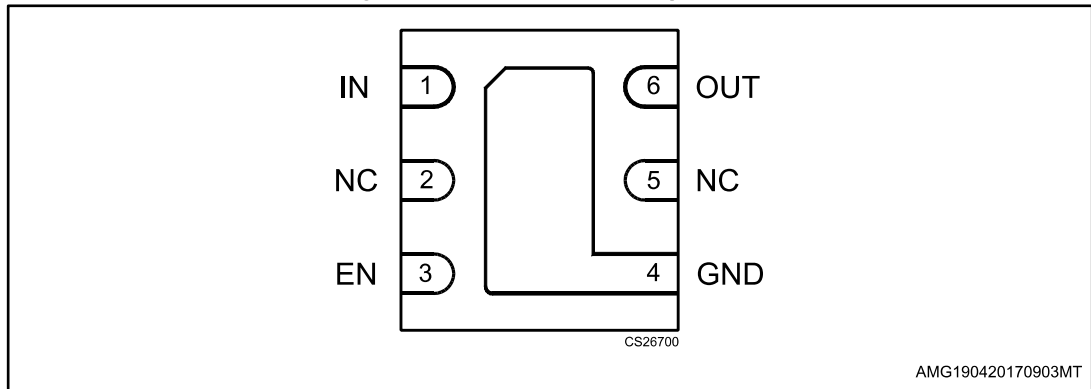

Table 2: Pin description

Pin	Symbol	Name and function
1	IN	Input voltage
2	NC	Not connected
3	EN	Enable input. Set $V_{EN} > 0.9$ to turn on the device Set $V_{EN} < 0.4$ to turn off the device
4	GND	Ground
5	NC	Not connected
6	OUT	Output voltage



Exposed pad is electrically connected to GND.

3 Maximum ratings

Table 3: Absolute maximum ratings

Symbol	Parameter	Value	Unit
V _{IN}	DC input voltage	-0.3 to 7	V
V _{OUT}	DC output voltage	From -0.3 to 4.6	V
V _{EN}	Enable input voltage	From -0.3 to V _{IN} + 0.3	V
I _{OUT}	Output current	Internally limited	mA
P _D	Power dissipation	Internally limited	mW
T _{STG}	Storage temperature range	-65 to 150	°C
T _{OP}	Operating junction temperature range	-40 to 125	°C
ESD	Human body model	±3	kV
	Machine model	±300	V



Absolute maximum ratings are those values beyond which damage to the device may occur. Functional operation under these conditions is not implied.

Table 4: Thermal data

Symbol	Parameter	Value	Unit
R _{thJA}	Thermal resistance junction-ambient	105	°C/W
R _{thJC}	Thermal resistance junction-case	20	°C/W

4 Electrical characteristics

$T_J = 25\text{ °C}$, $V_{IN} = V_{OUT(NOM)} + 1\text{ V}$, $C_{IN} = C_{OUT} = 0.47\text{ }\mu\text{F}$, $I_{OUT} = 1\text{ mA}$, $V_{EN} = V_{IN}$, unless otherwise specified.

Table 5: Electrical characteristics

Symbol	Parameter	Test condition	Min.	Typ.	Max.	Unit
V_{IN}	Operating input voltage		2.1		5.5	V
V_{OUT}	V_{OUT} accuracy	$I_{OUT} = 1\text{ mA}$	-1		1	%
		$-40\text{ °C} < T_J < 125\text{ °C}$, $I_{OUT} = \text{from } 1\text{ mA to } 150\text{ mA}$, $V_{IN} = V_{OUT(NOM)} + 1\text{ V to } 5.5\text{ V}$	-2		2	
ΔV_{OUT}	Static line regulation	$V_{OUT} + 1\text{ V} \leq V_{IN} \leq 5.5\text{ V}$, $I_{OUT} = 1\text{ mA}$		0.005		%/V
ΔV_{OUT}	Static load regulation	$I_{OUT} = 1\text{ mA to } 150\text{ mA}$		0.001		%/mA
V_{DROP}	Dropout voltage ⁽¹⁾	$I_{OUT} = 150\text{ mA}$, $V_{OUT} > 1.9\text{ V}$ $-40\text{ °C} < T_J < 125\text{ °C}$		86	180	mV
e_N	Output noise voltage	10 Hz to 100 kHz, $I_{OUT} = 0\text{ mA}$, $V_{OUT} = 1.0\text{ V}$		6.3		μV_{RMS}
		10 Hz to 100 kHz, $I_{OUT} = 150\text{ mA}$, $V_{OUT} = 1.0\text{ V}$		9.9		
SVR	Supply voltage rejection $V_{OUT} = 1.0\text{ V}$	$V_{IN} = V_{OUTNOM} + 1\text{ V } +/-V_{RIPPLE}$ $V_{RIPPLE} = 0.5\text{ V}$ Freq. = 1 kHz $I_{OUT} = 10\text{ mA}$		92		dB
		$V_{IN} = V_{OUTNOM} + 1\text{ V } +/-V_{RIPPLE}$ $V_{RIPPLE} = 0.5\text{ V}$ Freq. = 10 kHz $I_{OUT} = 10\text{ mA}$		89		
		$V_{IN} = V_{OUTNOM} + 1\text{ V } +/-V_{RIPPLE}$ $V_{RIPPLE} = 0.5\text{ V}$ Freq. = 100 kHz $I_{OUT} = 1\text{ mA}$		50		
I_Q	Quiescent current	$I_{OUT} = 0\text{ mA}$, $-40\text{ °C} < T_J < 125\text{ °C}$		35	60	μA
		$I_{OUT} = 150\text{ mA}$, $-40\text{ °C} < T_J < 125\text{ °C}$		70	120	
		V_{IN} input current in OFF mode $V_{EN} = \text{GND}$		0.002	2	
I_{SC}	Short-circuit current	$R_L = 0$ $V_{IN} = 2.0\text{ V}$	300			mA

Symbol	Parameter	Test condition	Min.	Typ.	Max.	Unit
V _{EN}	Enable input logic low	V _{IN} = 2.1 V to 5.5 V, -40 °C < T _J < 125 °C			0.4	V
	Enable input logic high	V _{IN} = 2.1 V to 5.5 V, -40 °C < T _J < 125 °C	0.9			
I _{EN}	Enable pin input current	V _{EN} = 5.5 V		0.1	100	nA
T _{ON}	Turn-on time ⁽²⁾			110		μs
T _{SHDN}	Thermal shutdown			166		°C
	Hysteresis			10		
C _{OUT}	Output capacitor	Capacitance (see Figure 15: "Stability area")	0.33		4.7	μF

Notes:

⁽¹⁾Dropout voltage is the input-to-output voltage difference at which the output voltage is 100 mV below its nominal value. This specification does not apply for output voltages below 2 V.

⁽²⁾Turn-on time is time measured between the enable input just exceeding V_{EN} high value and the output voltage just reaching 95% of its nominal value.

Note:

- For V_{OUT(NOM)} < 1.0 V, V_{IN} = 2 V
- All transient values are guaranteed by design, not production tested

5 Typical performance characteristics

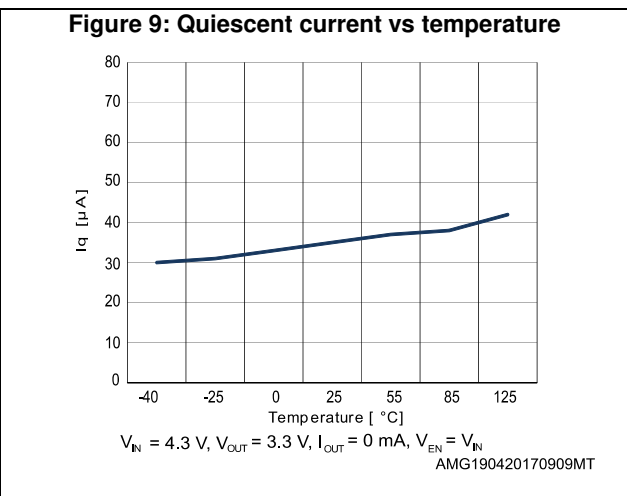
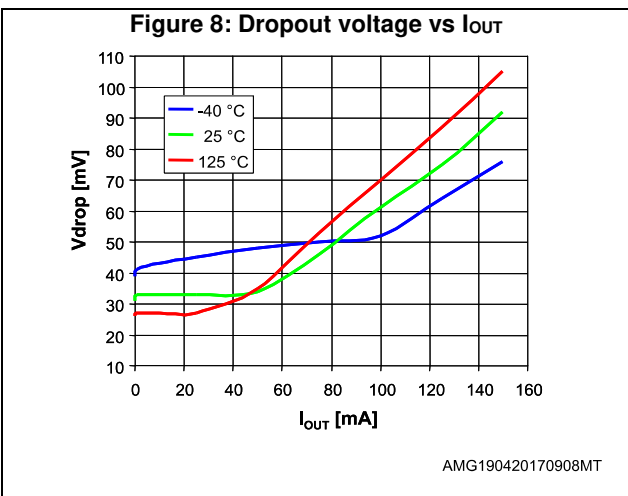
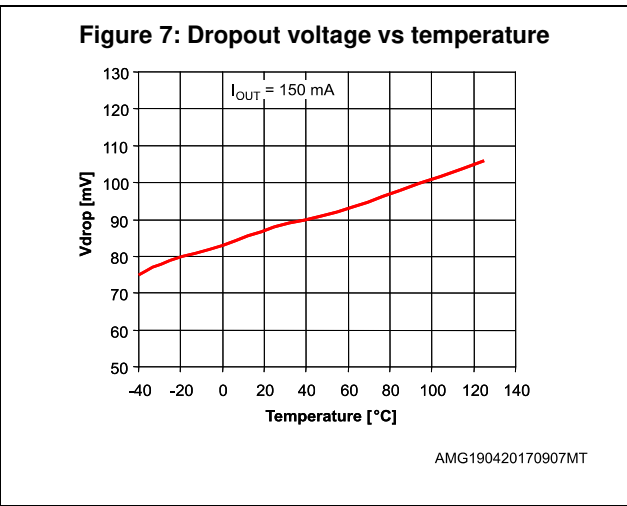
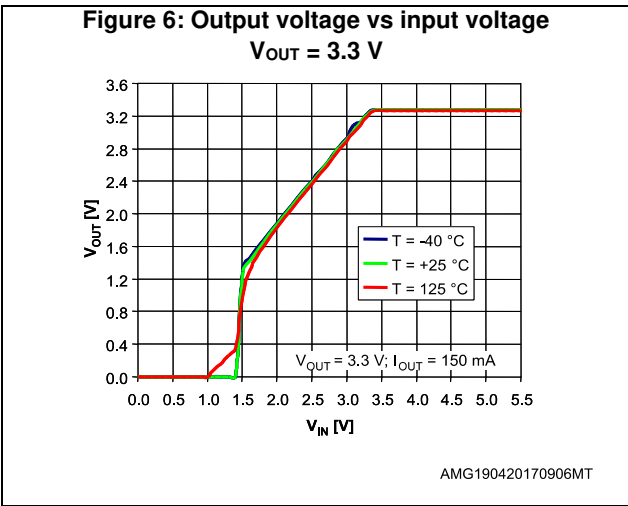
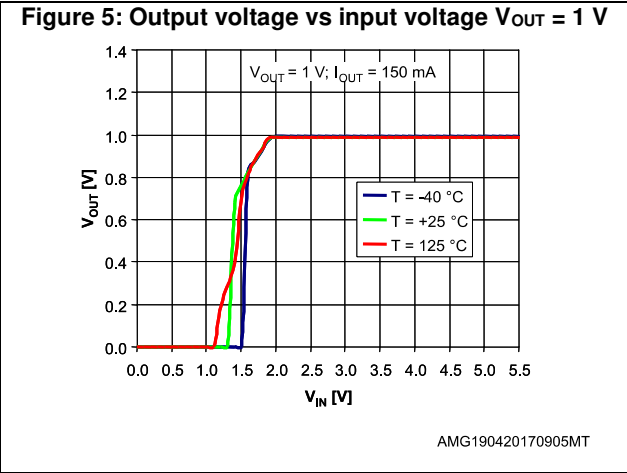
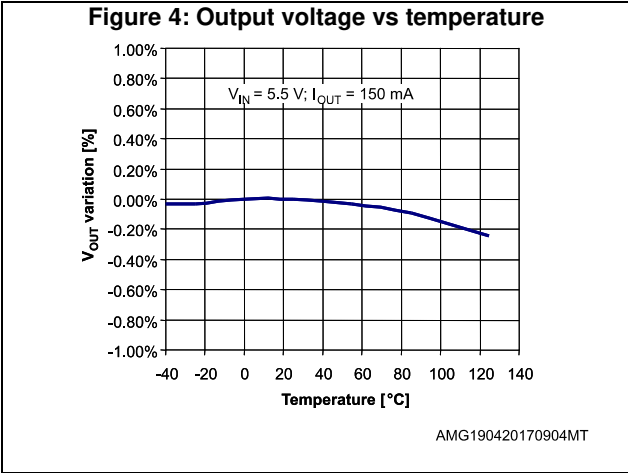

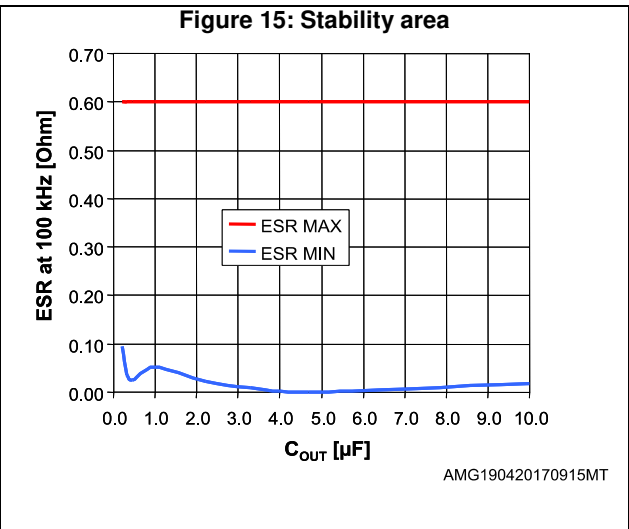
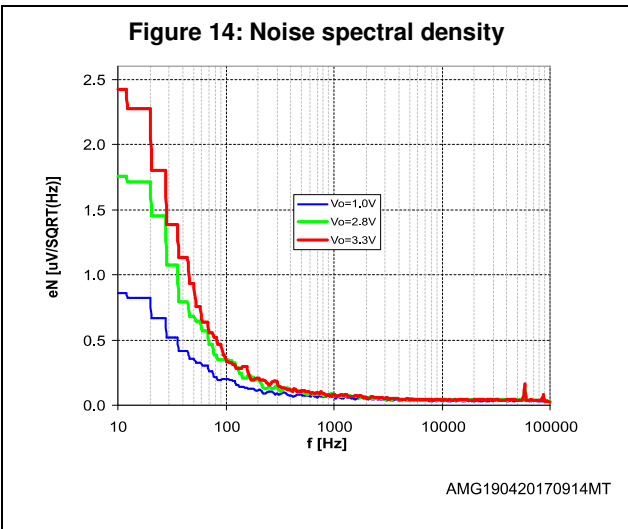
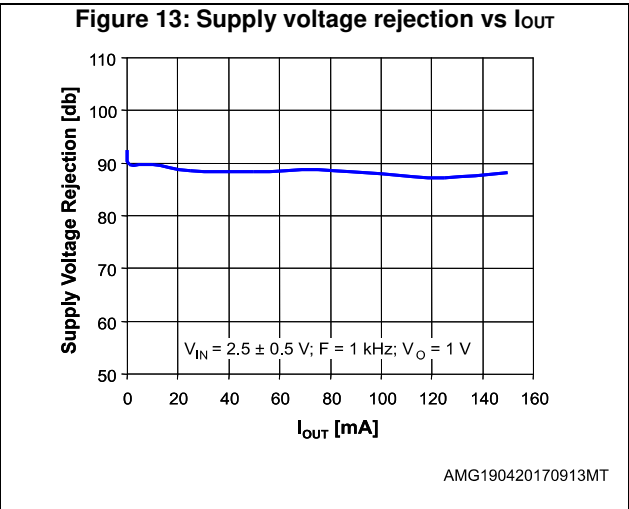
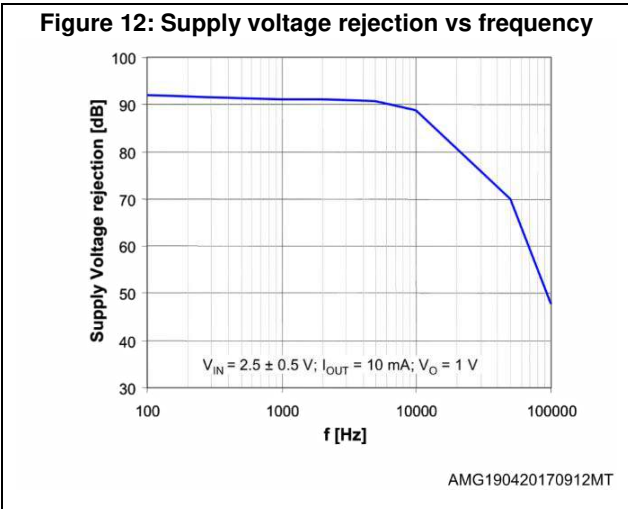
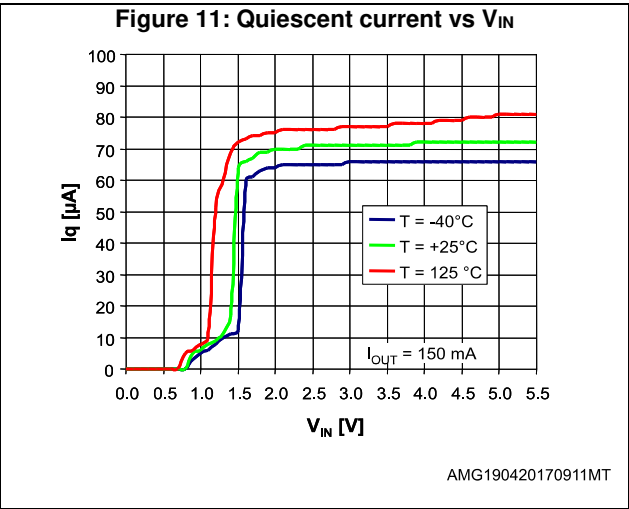
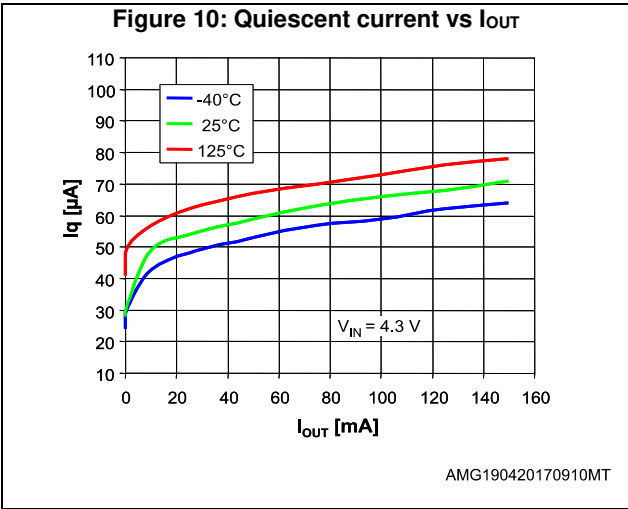
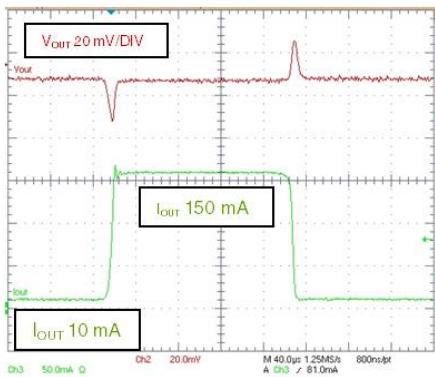

Figure 16: Load transient



I_{OUT} = from 10 to 150 mA; $t_{rise} = t_{fall} = 5 \mu s$

AMG190420170916MT

Figure 17: Line transient at $I_{OUT} = 1 \text{ mA}$

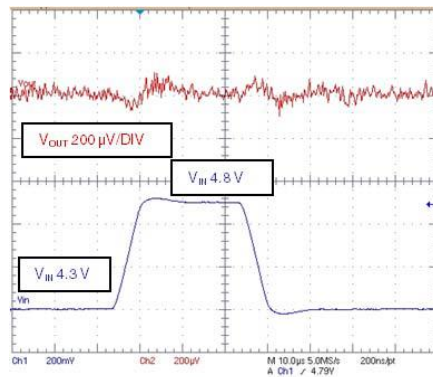

V_{IN} = from 4.3 to 4.8 V; $I_{OUT} = 1 \text{ mA}$; $t_{rise} = t_{fall} = 5 \mu s$

AMG190420170917MT

Figure 18: Line transient at $I_{OUT} = 150 \text{ mA}$

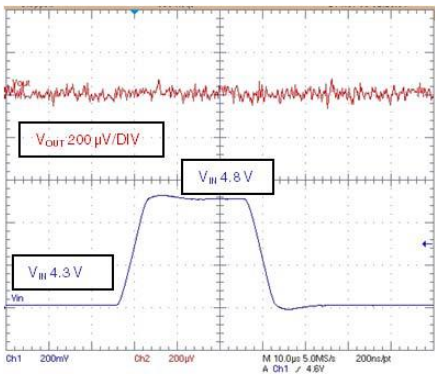

V_{IN} = from 4.3 to 4.8 V; $I_{OUT} = 150 \text{ mA}$; $t_{rise} = t_{fall} = 5 \mu s$

AMG190420170918MT

Figure 19: Turn-on time at $I_{OUT} = 1 \text{ mA}$; $V_{OUT} = 1 \text{ V}$

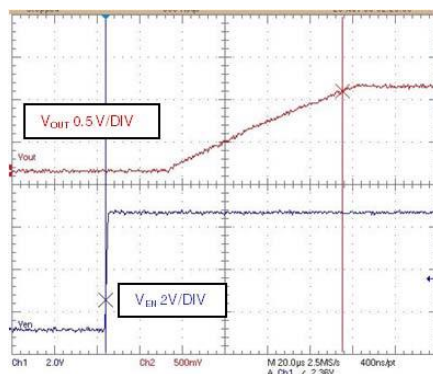

$V_{IN} = 2 \text{ V}$; $V_O = 1 \text{ V}$; $I_{OUT} = 1 \text{ mA}$

AMG190420170919MT

Figure 20: Turn-on time at $I_{OUT} = 150 \text{ mA}$, $V_{OUT} = 1 \text{ V}$

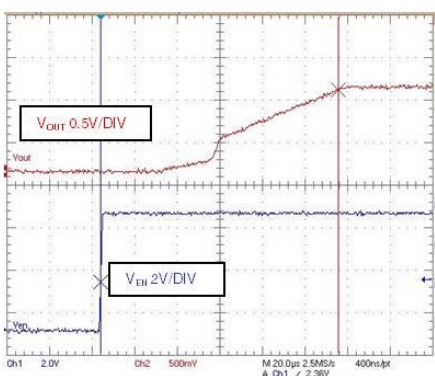

$V_{IN} = 2 \text{ V}$; $V_O = 1 \text{ V}$; $I_{OUT} = 150 \text{ mA}$

AMG190420170920MT

Figure 21: Turn-on time at $I_{OUT} = 1 \text{ mA}$; $V_{OUT} = 3.3 \text{ V}$

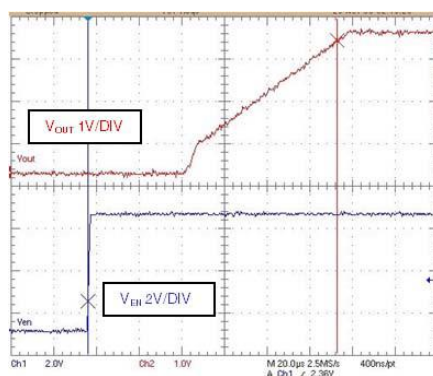

$V_{IN} = 4.3 \text{ V}$; $V_O = 3.3 \text{ V}$; $I_{OUT} = 1 \text{ mA}$

AMG190420170921MT

Figure 22: Turn-on time at $I_{OUT} = 150 \text{ mA}$, $V_{OUT} = 3.3 \text{ V}$

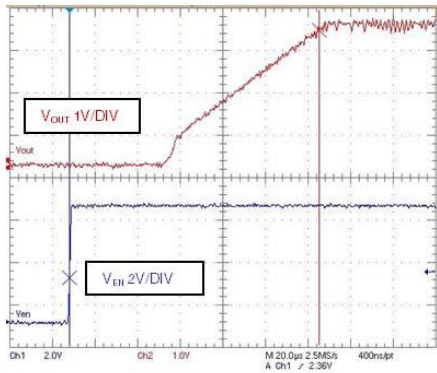

$V_{IN} = 4.3 \text{ V}$; $V_O = 3.3 \text{ V}$; $I_{OUT} = 150 \text{ mA}$

AMG190420170922MT

Figure 23: Startup transient

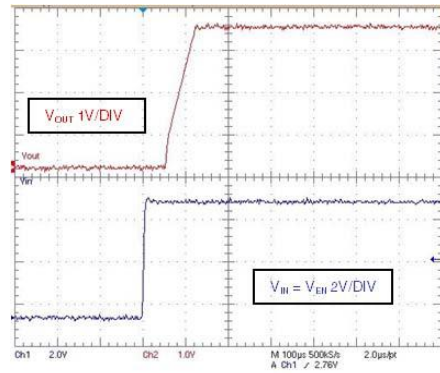

$V_O = 3.3 \text{ V}$; $I_{OUT} = 150 \text{ mA}$

AMG190420170923MT

6 Package information

In order to meet environmental requirements, ST offers these devices in different grades of ECOPACK® packages, depending on their level of environmental compliance. ECOPACK® specifications, grade definitions and product status are available at: www.st.com. ECOPACK® is an ST trademark.

6.1 DFN6 (2 x 2 mm) package information

Figure 24: DFN6 (2 x 2 mm) package outline

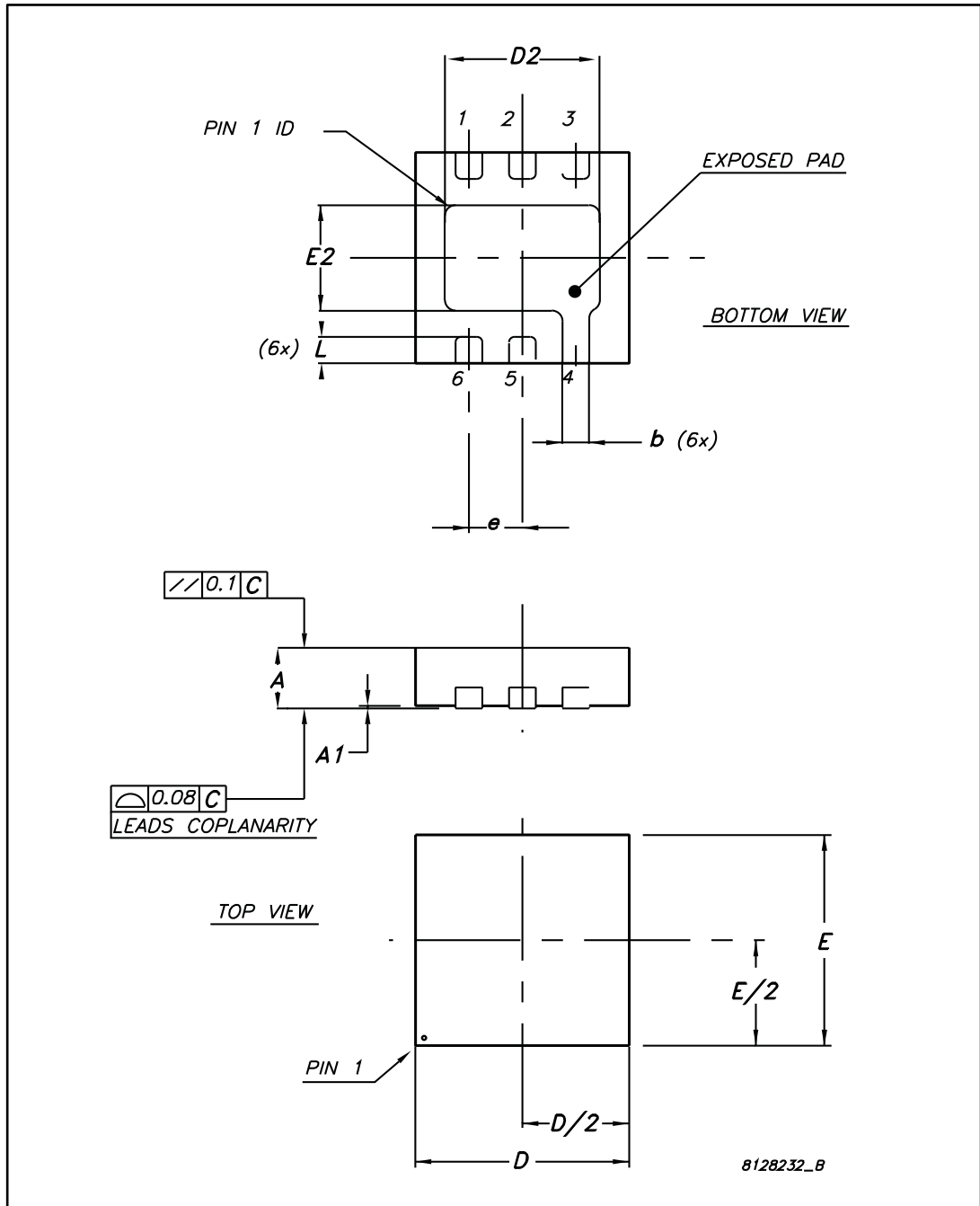
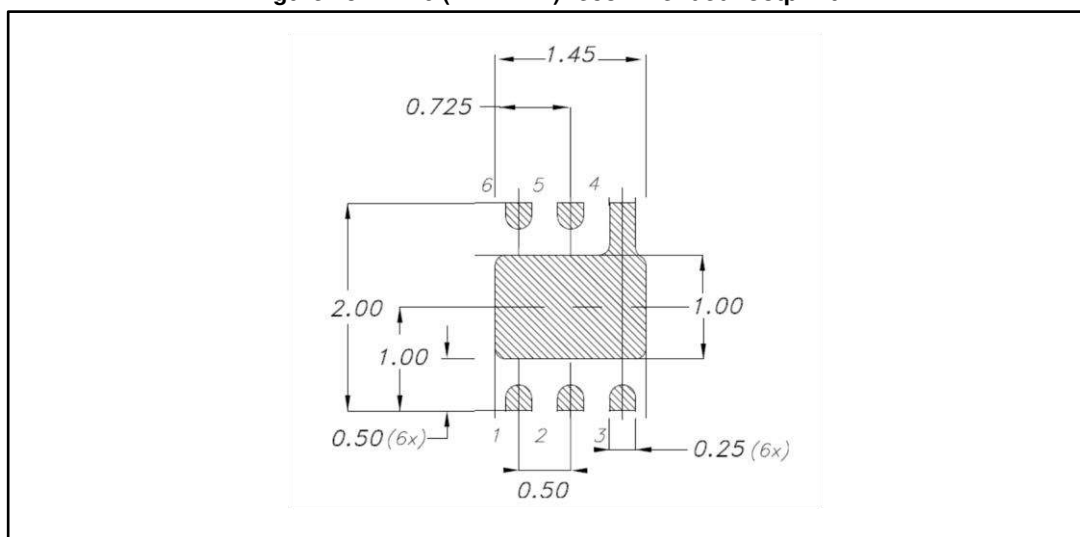

Table 6: DFN6 (2 x 2 mm) mechanical data

Dim.	mm		
	Min.	Typ.	Max.
A	0.51	0.55	0.60
A1	0	0.02	0.05
b	0.18	0.25	0.30
D		2.00	
D2	1.30	1.45	1.55
E		2.00	
E2	0.85	1.00	1.10
e		0.50	
L	0.15	0.25	0.35

Figure 25: DFN6 (2 x 2 mm) recommended footprint



6.2 DFN6 (2 x 2 mm) packing information

Figure 26: DFN6 (2 x 2 mm) reel outline

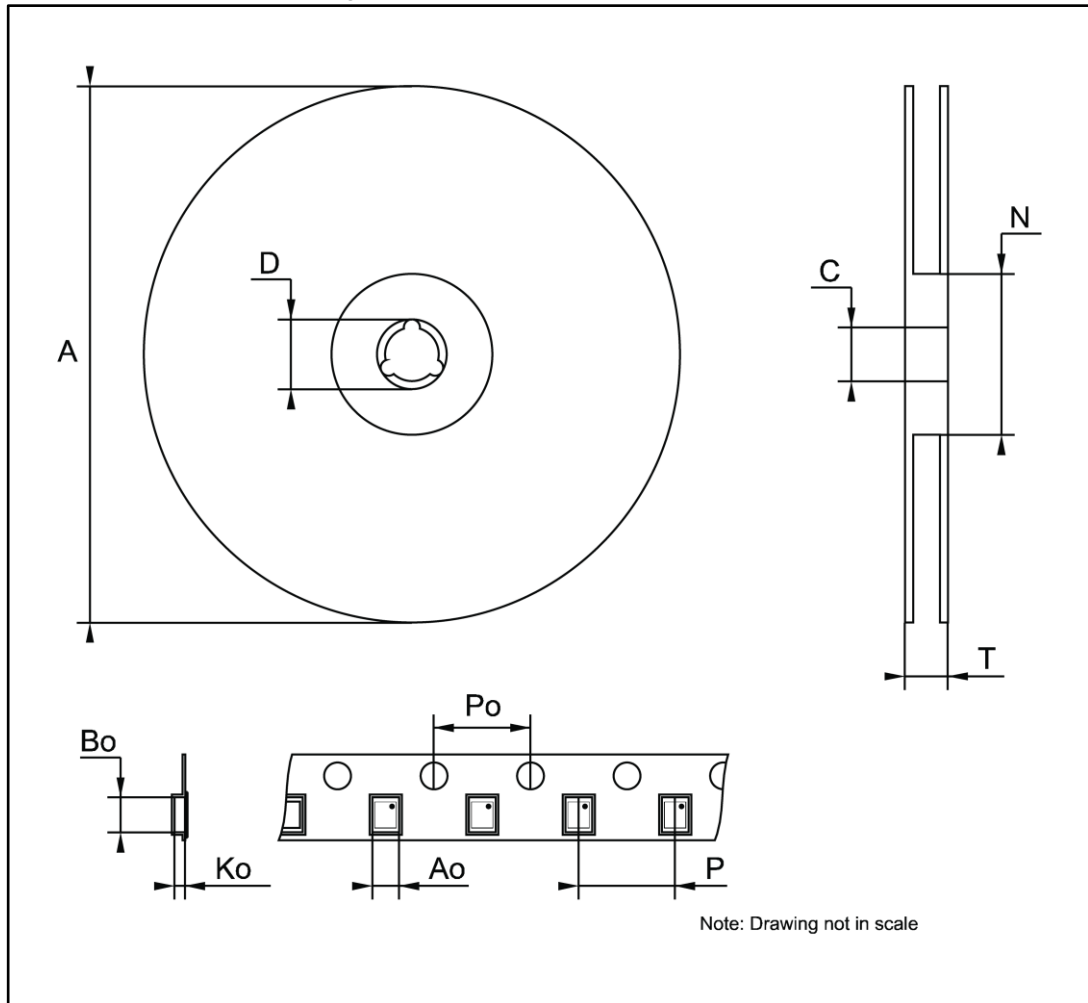

Table 7: DFN6 (2 x 2 mm) tape and reel mechanical data

Dim.	mm		
	Min.	Typ.	Max.
A			180
C	12.8		13.2
D	20.2		
N	60		
T			14.4
A0		2.4	
B0		2.4	
K0		1.3	
P0		4	
P		4	

7 Revision history

Table 8: Document revision history

Date	Revision	Changes
31-Jan-2012	1	Initial release.
15-Jan-2014	2	Changed the LDLN015xx to LDLN015. Updated the Description in cover page. Updated Table 1: Device summary, Section 5: Typical performance characteristics and Section 6: Package information. Added Section 6.2: DFN6 (2 x 2 mm) packing information. Minor text changes.
14-Jan-2015	3	Updated the features in cover page. Updated Table 5: Electrical characteristics and Figure 9: Quiescent current vs. temperature. Minor text changes.
26-Oct-2015	4	Modified Section 6: Package information. Minor text changes.
18-May-2017	5	Updated Section 6.1: "DFN6 (2 x 2 mm) package information" . Minor text changes.

IMPORTANT NOTICE – PLEASE READ CAREFULLY

STMicroelectronics NV and its subsidiaries ("ST") reserve the right to make changes, corrections, enhancements, modifications, and improvements to ST products and/or to this document at any time without notice. Purchasers should obtain the latest relevant information on ST products before placing orders. ST products are sold pursuant to ST's terms and conditions of sale in place at the time of order acknowledgement.

Purchasers are solely responsible for the choice, selection, and use of ST products and ST assumes no liability for application assistance or the design of Purchasers' products.

No license, express or implied, to any intellectual property right is granted by ST herein.

Resale of ST products with provisions different from the information set forth herein shall void any warranty granted by ST for such product.

ST and the ST logo are trademarks of ST. All other product or service names are the property of their respective owners.

Information in this document supersedes and replaces information previously supplied in any prior versions of this document.

© 2017 STMicroelectronics – All rights reserved