

NEW

PTS645V Series 6 mm SMT Side Actuated Tact Switch

Features/Benefits

- Full SMT processing
- Strong PCB soldering pads
- Compact 6 x 6 mm design

Typical Applications

- Consumer Products
- Set Top and Access Boxes
- Instrumentation
- Home and Garden Equipment



Specification

FUNCTION: Momentary action
 CONTACT ARRANGEMENT: 1 make contact = SPST, N.O.
 TERMINALS: G type for SMT
 TRAVEL: PTS645V: 0.25 +0.2/-0.1 mm
 PTS645VS: 0.35 +0.2/-0.1mm
 OPERATING LIFE: 100,000 cycles

Environmental

OPERATING TEMPERATURE: -40°C to 85°C
 STORAGE TEMPERATURE: -40°C to 85°C

Process

SOLDERING: This component is suited to the following methods:
 Infrared Reflow Soldering in accordance with IEC61760-1

Mechanical

Part Number	Operating Force (gf)	Actuator Color
PTS645VN13SMTR92 LFS	100	Dark Grey
PTS645VM13SMTR92 LFS	160	Yellow Green
PTS645VSN19PSMTR92 LFS	100	Grey
PTS645VSM19PSMTR92 LFS	160	Black
PTS645VSK19PSMTR92 LFS	260	Red
PTS645VSP19PSMTR92 LFS	320	Yellow

Recommended solder paste thickness is $\geq 15\mu\text{m}$

Packaging

In reels of 650 pieces
 Dimensions of reels according to EIA 481B
 External diameter 330 mm

NOTE:

- Specifications listed above are for switches with standard options. For information on specific and custom switches, consult Customer Service Center.
- The PTS series is not certified for using in Automotive application and no PPAP. However, in the case of some automotive accessories and specific applications for 2 and 3 wheeled vehicles the PTS is widely used and very suitable. Please contact your local C&K representative to discuss your application and the best switch solution.

Electrical

MAXIMUM VOLTAGE: 12 V DC
 MAXIMUM CURRENT: 50 mA
 DIELECTRIC STRENGTH: 100 V AC (1mn)
 CONTACT RESISTANCE: $\leq 100\text{ m}\Omega$
 INSULATION RESISTANCE: $\geq 100\text{ M}\Omega$
 BOUNCE TIME: $\leq 10\text{ ms}$

How To Order

Our easy build-a-switch concept allows you to mix and match options to create the switch you need. To order, select desired option from each category and and place it in the appropriate box.

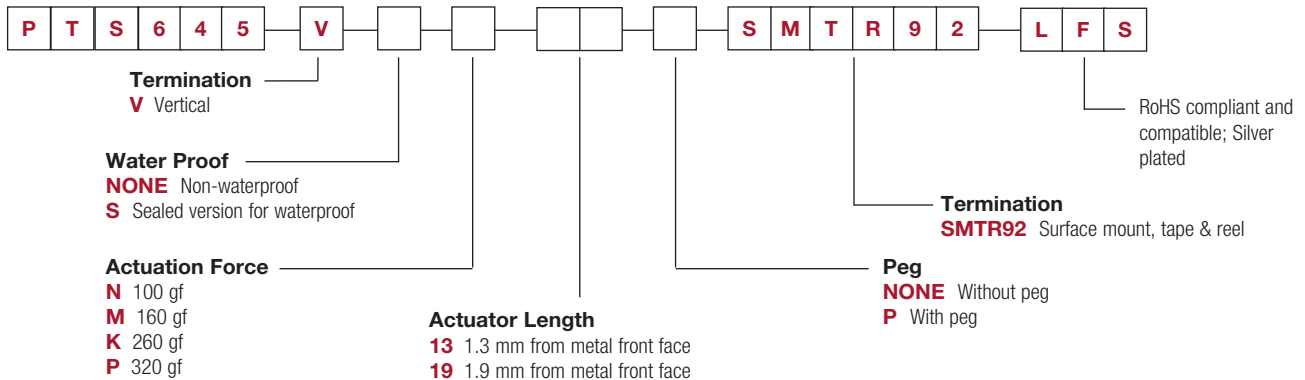

* Sealed version with IP67 is currently only for 1.9mm actuator length.
 For other lengths, please contact your local C&K representative.



PTS645V Series 6 mm SMT Side Actuated Tact Switch

NEW

STANDARD VERSION WITHOUT PEG

RECOMMENDED PCB LAYOUT

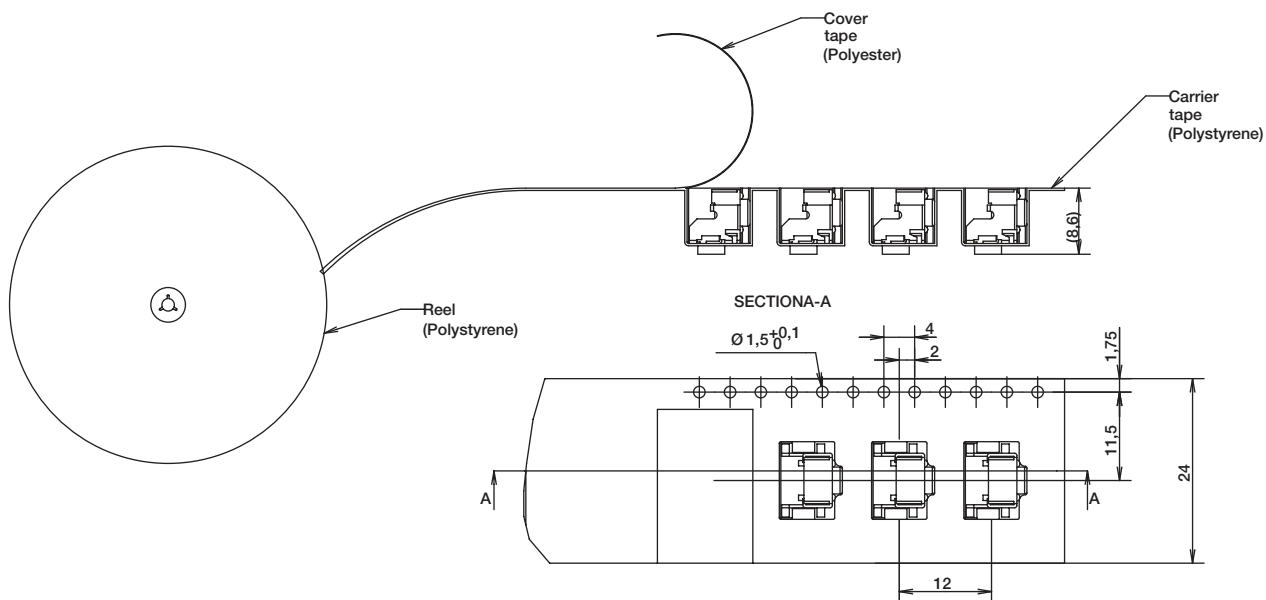
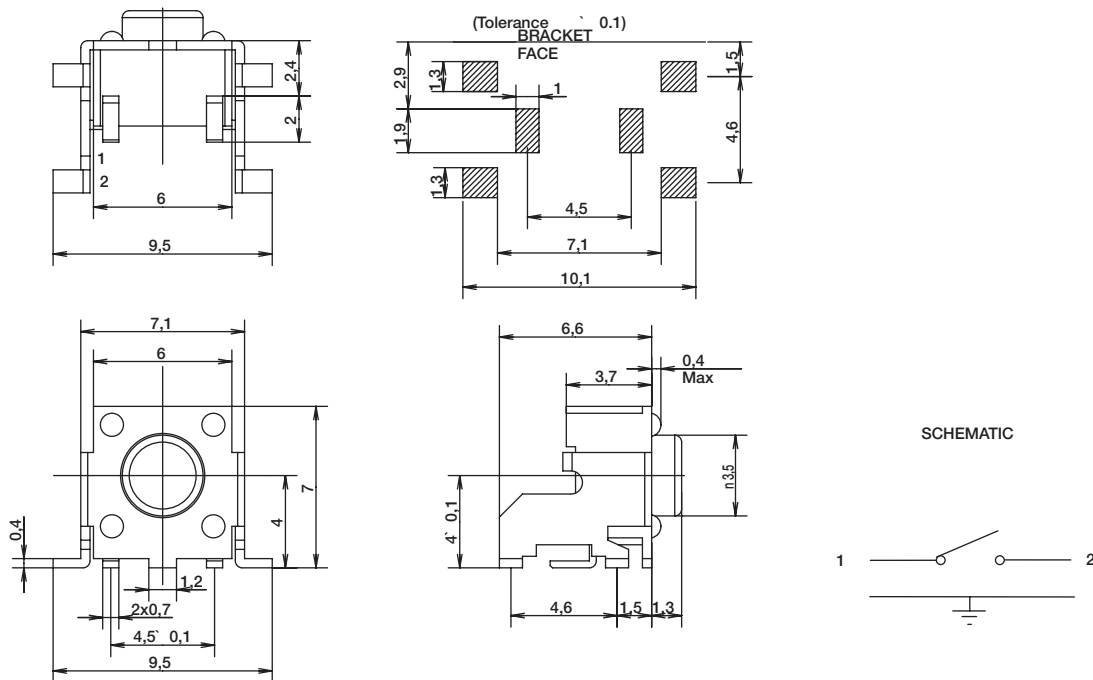

PTS645V Series 6 mm SMT Side Actuated Tact Switch

NEW

VERSION WITH PEG

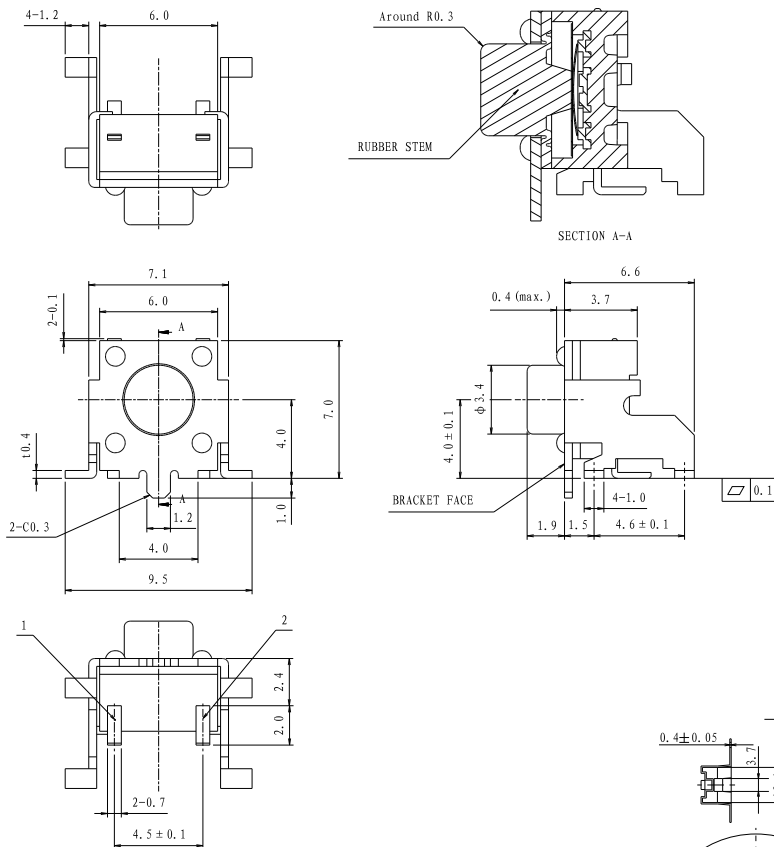

P. C. B SOLDER LAND DIMENSIONS

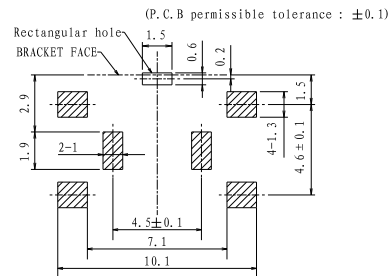

CIRCUIT DIAGRAM

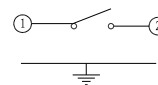

PACKAGE

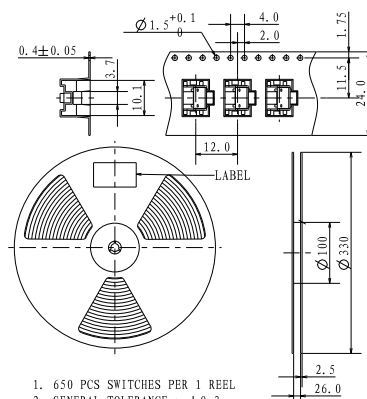

1. 650 PCS SWITCHES PER 1 REEL
2. GENERAL TOLERANCE : ±0.3

Tactile Switches