

4

3

2

1

THIS DRAWING IS UNPUBLISHED.

RELEASED FOR PUBLICATION

,19

© COPYRIGHT 19

BY AMP INCORPORATED. ALL RIGHTS RESERVED.

LOC DS

DIST

REVISIONS

P	LTR	DESCRIPTION	DATE	DWN	APVD
A		REVISED<FC00-0056-05>	28/FEB/'05	BH	CS
B		REVISED<ECR-09-004879>	03/MAR/'09	YC	HG

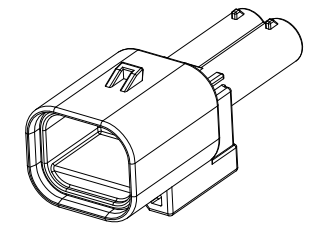
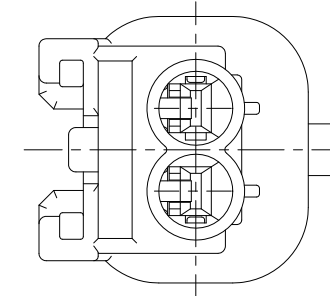
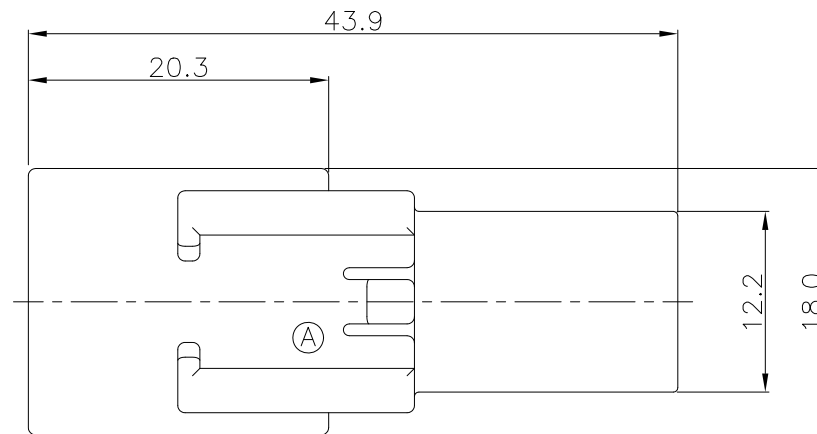
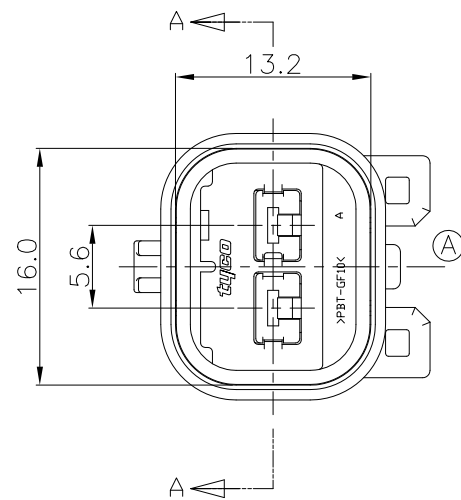

3D VIEW<SCALE 1:1>

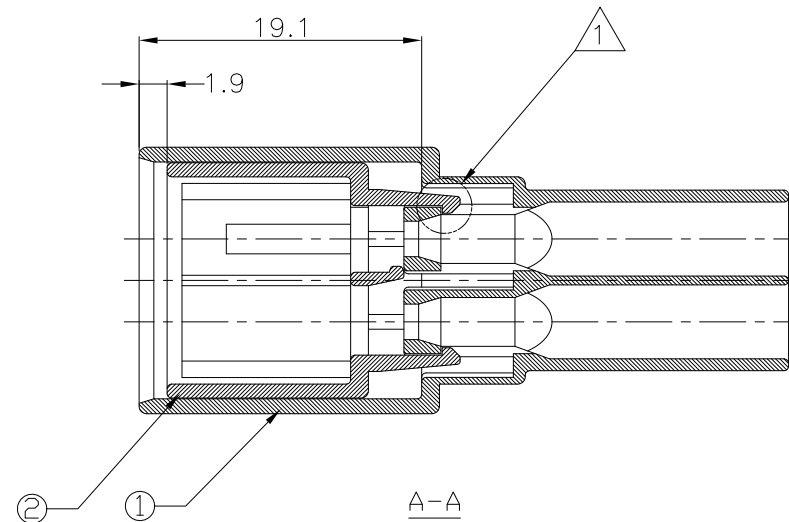
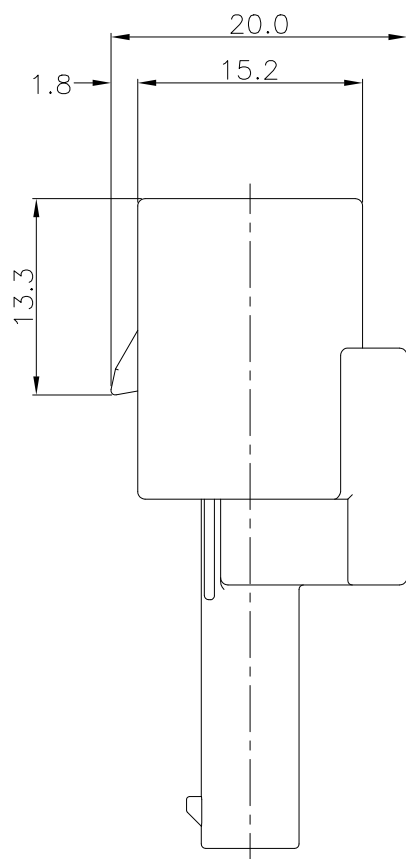

NOTES

1. CONDITION OF DELIVERY : DBL PLATE IN OPEN POSITION.

2. APPLIED TAB CONTACT P/N:

CONTACT	.090 TERMINAL		
Part NO.	936260-1	936261-1	936262-1
WIRE SIZE(mm ²)	0.3-AVS0.5	0.85-AVS1.25	AVSS2.0, AESSXF2.5

3. APPLIED FEMALE CONNECTOR P/N : 936248-X

4. APPLIED WIRE COVER HSG P/N : 936311-1
(CORRUGATOR DIA : Ø5)

NO.	COLOR	MATERIAL	DESCRIPTION	QTY	ASSY P/N
2	WHITE	PBT GF10	DBL PLATE	1	936291-8
1	BLUE	PBT	CAP HSG	1	936291-2
1	BLACK	PBT	CAP HSG	1	

THIS DRAWING IS A CONTROLLED DOCUMENT FOR AMP INCORPORATED. IT IS SUBJECT TO CHANGE AND THE CONTROLLING ENGINEERING ORGANIZATION SHOULD BE CONTACTED FOR THE LATEST REVISION.

DWN : YC LEE

CHK : YM CHOI

APVD : HG CHO

PRODUCT SPEC

APPLICATION SPEC

WEIGHT

CUSTOMER DRAWING

DIMENSIONS: MM

TOLERANCES UNLESS OTHERWISE SPECIFIED:

0 <XX<10 ± 0.2
 10<XX<30 ± 0.25
 30<XX ± 0.3
 ANGLES ± 3°

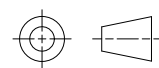

3rd ANGLE PROJECTION

MATERIAL

SEE TABLE

FINISH



AMP KOREA, kyungsan, korea

NAME

.090 SEALED 2P CAP ASS'Y

SIZE

CAGE CODE

DRAWING NO

A3

00779

936291

SCALE 2/1

SHEET 1 OF 1

REV B