

RECOMMENDED PCB LAYOUT (CONNECTOR SIDE VIEW)
 THICKNESS=1.6mm MIN. TOLERANCE: ±0.05
 RECOMMENDED STENCIL THICKNESS=0.2MM.

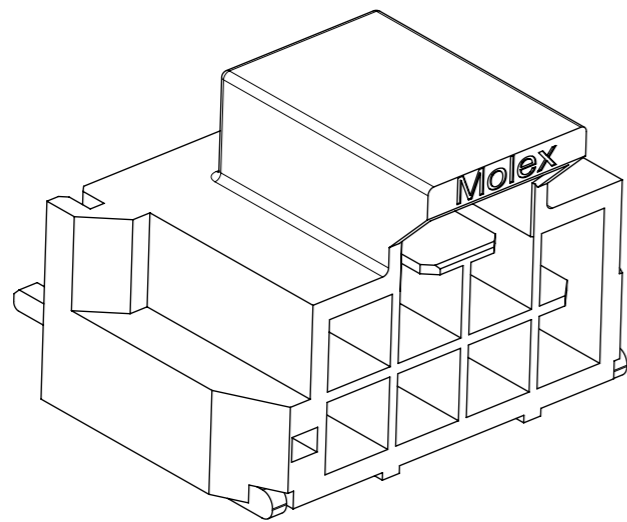

THIS DRAWING CONTAINS INFORMATION THAT IS PROPRIETARY TO MOLEX ELECTRONIC TECHNOLOGIES, LLC AND SHOULD NOT BE USED WITHOUT WRITTEN PERMISSION											
QUALITY SYMBOLS	2019/10/10	2019/10/10	2019/10/10	GENERAL TOLERANCES (UNLESS SPECIFIED)		DIMENSION UNITS	SCALE				
	2019/10/10	2019/10/10	2019/10/10	ANGULAR TOL ± 3.0 °		mm	5:1				
▽A = 0	EC NO: 625433	DRWN: GLLI	CHK'D: YXZHENG	APPR: YXZHENG	4 PLACES ±	DRWN BY	DATE	SD DRAWING FOR SMT HEADER OF NANO-FIT RA DUAL			
▽E = 0					3 PLACES ±	RFC_PLMMW	2016/01/04				
▽F = 0					2 PLACES ± 0.2	CHK'D BY	DATE	PRODUCT CUSTOMER DRAWING			
▽ = 0					1 PLACE ± 0.3	APPR BY	DATE				
▽C = 0					0 PLACES ±	AYIN	2016/01/04	SERIES	MATERIAL NUMBER	CUSTOMER	
⊗ = 0	DRAFT WHERE APPLICABLE MUST REMAIN WITHIN DIMENSIONS		DRAWING SIZE	THIRD ANGLE PROJECTION	105405	GENERAL MARKET					
■ = 0			A3		DOCUMENT NUMBER	DOC TYPE	DOC PART	SHEET NUMBER			
▽ = 0					SD-105405-001	PSD	000	1 OF 4			

9 8 7 6 5 4 3 2 1

E
D
C
B
A

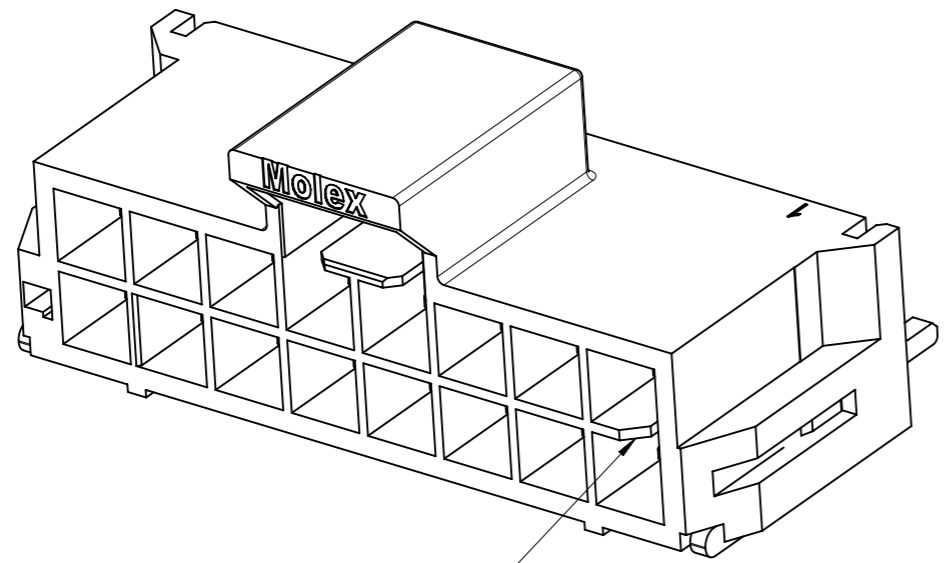

KEY A

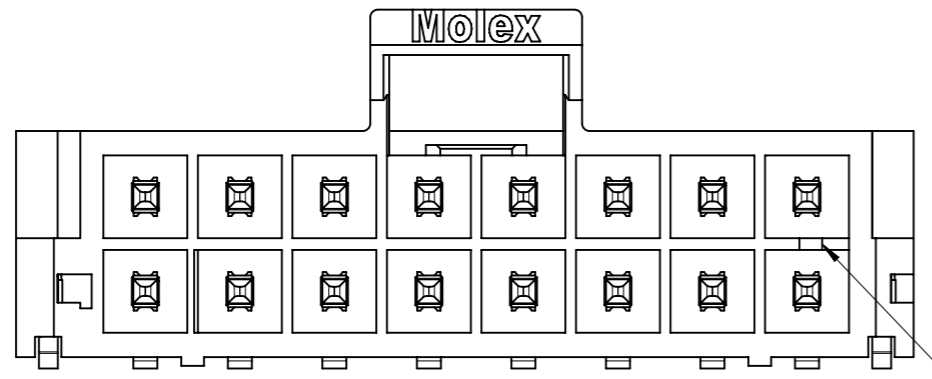

KEY A

BLACK

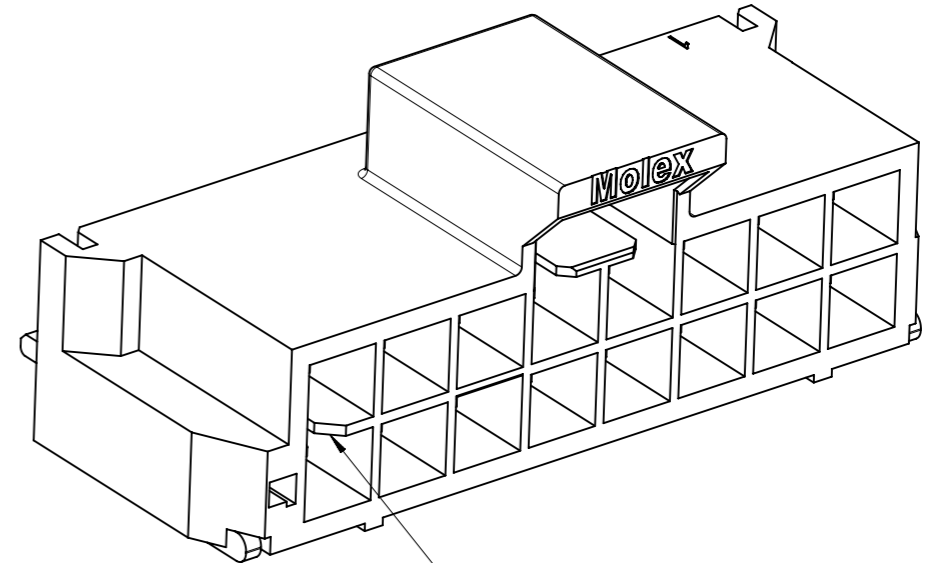

KEY B

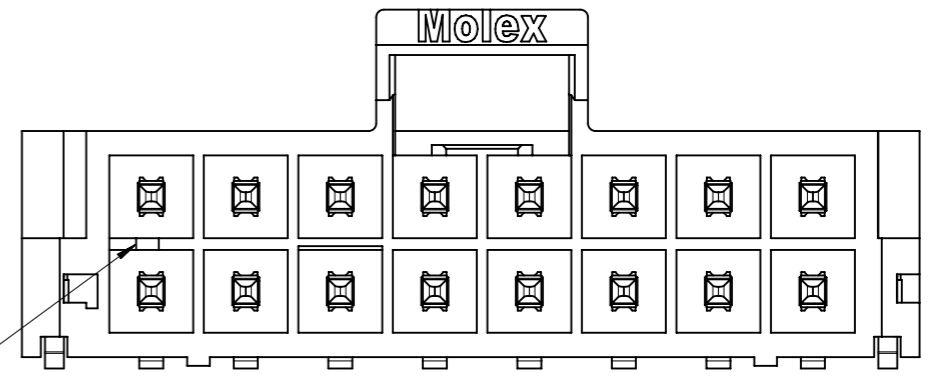

KEY B

NATURAL

COLOR OPTION

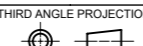
THIS DRAWING CONTAINS INFORMATION THAT IS PROPRIETARY TO MOLEX ELECTRONIC TECHNOLOGIES, LLC AND SHOULD NOT BE USED WITHOUT WRITTEN PERMISSION									
SYMBOLS	DIMENSION UNITS	SCALE	CURRENT REV DESC: RE-MASTER IN ECTR						
	mm								
▽ = 0	GENERAL TOLERANCES (UNLESS SPECIFIED)		EC NO: 625433				SD DRAWING FOR		
▽ = 0	ANGULAR TOL ± 3.0°		DRWN: GLLI 2019/10/10				SMT HEADER OF NANO-FIT RA DUAL		
▽ = 0	4 PLACES ±		CHK'D: YXZHENG 2019/10/10				PRODUCT CUSTOMER DRAWING		
▽ = 0	3 PLACES ±		APPR: YXZHENG 2019/10/10				DOCUMENT NUMBER		
▽ = 0	2 PLACES ± 0.2		INITIAL REVISION:				SD-105405-001		
▽ = 0	1 PLACE ± 0.3		DRWN: RFC_PLMMW 2016/01/04				DOC TYPE		
▽ = 0	0 PLACES ±		APPR: JALEXANDER 2016/01/04				PSD		
☒ = 0	DRAFT WHERE APPLICABLE MUST REMAIN WITHIN DIMENSIONS		THIRD ANGLE PROJECTION		DRAWING	SERIES	MATERIAL NUMBER	CUSTOMER	REVISION
▽ = 0					A3-SIZE	105405	GENERAL MARKET	000	E
							SHEET NUMBER		2 OF 4

DOCUMENT STATUS	P1	RELEASE DATE	2019/10/10	06:03:13
-----------------	----	--------------	------------	----------

9 8 7 6 5 4 3 2 1

	9	8	7	6	5	4	3	2	1
	PART NUMBER	DIM. A	DIM. B	DIM. C	DIM. D	CKT SIZE	PLATING	LUBE	
E	105405-1104	8.74	3.82	2.50	7.04	4	TIN		
	105405-1106	11.24	5.07	5.00	9.54	6			
	105405-1108	13.74	6.32	7.50	12.04	8			
	105405-1110	16.24	7.57	10.00	14.54	10			
	105405-1112	18.74	8.82	12.50	17.04	12			
	105405-1114	21.24	10.07	15.00	19.54	14			
	105405-1116	23.74	11.32	17.50	22.04	16			
	105405-1204	8.74	3.82	2.50	7.04	4			
	105405-1206	11.24	5.07	5.00	9.54	6			
	105405-1208	13.74	6.32	7.50	12.04	8			
	105405-1210	16.24	7.57	10.00	14.54	10			
	105405-1212	18.74	8.82	12.50	17.04	12			
	105405-1214	21.24	10.07	15.00	19.54	14			
	105405-1216	23.74	11.32	17.50	22.04	16			
D	105405-1304	8.74	3.82	2.50	7.04	4			
	105405-1306	11.24	5.07	5.00	9.54	6			
	105405-1308	13.74	6.32	7.50	12.04	8			
	105405-1310	16.24	7.57	10.00	14.54	10			
	105405-1312	18.74	8.82	12.50	17.04	12			
	105405-1314	21.24	10.07	15.00	19.54	14			
	105405-1316	23.74	11.32	17.50	22.04	16			
	105405-1404	8.74	3.82	2.50	7.04	4			
	105405-1406	11.24	5.07	5.00	9.54	6			
	105405-1408	13.74	6.32	7.50	12.04	8			
	105405-1410	16.24	7.57	10.00	14.54	10			
	105405-1412	18.74	8.82	12.50	17.04	12			
	105405-1414	21.24	10.07	15.00	19.54	14			
C	105405-1416	23.74	11.32	17.50	22.04	16			

COLOR: BLACK

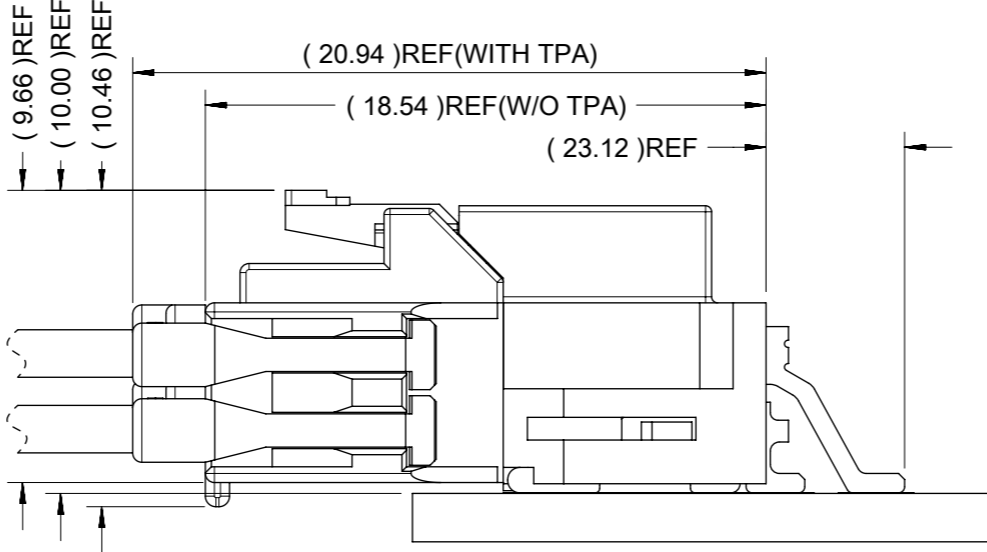

PART NUMBER	PACKING DRAWING
105405-XX04	PK-105405-001
105405-XX06	PK-105405-002
105405-XX08	PK-105405-003
105405-XX10	
105405-XX12	PK-105405-004
105405-XX14	
105405-XX16	
105405-XX16	

	PART NUMBER	DIM. A	DIM. B	DIM. C	DIM. D	CKT SIZE	PLATING	LUBE
	105405-2104	8.74	3.82	2.50	7.04	4	TIN	
	105405-2106	11.24	5.07	5.00	9.54	6		
	105405-2108	13.74	6.32	7.50	12.04	8		
	105405-2110	16.24	7.57	10.00	14.54	10		
	105405-2112	18.74	8.82	12.50	17.04	12		
	105405-2114	21.24	10.07	15.00	19.54	14		
	105405-2116	23.74	11.32	17.50	22.04	16		
	105405-2204	8.74	3.82	2.50	7.04	4		
	105405-2206	11.24	5.07	5.00	9.54	6		
	105405-2208	13.74	6.32	7.50	12.04	8		
	105405-2210	16.24	7.57	10.00	14.54	10		
	105405-2212	18.74	8.82	12.50	17.04	12		
	105405-2214	21.24	10.07	15.00	19.54	14		
	105405-2216	23.74	11.32	17.50	22.04	16		
	105405-2304	8.74	3.82	2.50	7.04	4		
	105405-2306	11.24	5.07	5.00	9.54	6		
	105405-2308	13.74	6.32	7.50	12.04	8		
	105405-2310	16.24	7.57	10.00	14.54	10		
	105405-2312	18.74	8.82	12.50	17.04	12		
	105405-2314	21.24	10.07	15.00	19.54	14		
	105405-2316	23.74	11.32	17.50	22.04	16		
	105405-2404	8.74	3.82	2.50	7.04	4		
	105405-2406	11.24	5.07	5.00	9.54	6		
	105405-2408	13.74	6.32	7.50	12.04	8		
	105405-2410	16.24	7.57	10.00	14.54	10		
	105405-2412	18.74	8.82	12.50	17.04	12		
	105405-2414	21.24	10.07	15.00	19.54	14		
	105405-2416	23.74	11.32	17.50	22.04	16		

COLOR: NATURAL

NOTES FOR ALL PARTS

1> MATERIAL:
HOUSING: LCP, UL 94V-0.
TERMINAL: BRASS.
SOLDER CLIP: BRASS.
2> PLATING FINISHED:
TERMINAL:
CONTACT AREA:
a. REFLOWED MATTE TIN 0.76 MICRONS MIN; b. GOLD 0.38 MICRONS MIN; c. GOLD 0.76 MICRONS MIN.
SOLDER AREA: TIN 0.76 MICRONS MINIMUM.
UNDER PLATING NICKEL 1.25 MICRONS MINIMUM.
SOLDER CLIP: TIN 2.5 MICRONS MINIMUM; UNDER PLATING NICKEL 1.25 MICRONS MINIMUM.

3> PRODUCT SPECIFICATION: PS-105405-001.
4> PACKAGE: REEL, OTHER INFORMATION REFER TO CHAT.
5> ALL COMPONENTS AND PRODUCT COMPLIANT TO RoHS DIRECTIVE 2011/65/EU AND ELV DIRECTIVE 2000/53/EC.
6> PRODUCT MATE WITH SERIES OF 105308(RECEPTACLE), 105300(CRIMP TERMINAL).
7> PARTS CONFORM TO CLASS 'B' REQUIREMENTS OF COSMETIC SPECIFICATION PS-45499-002.

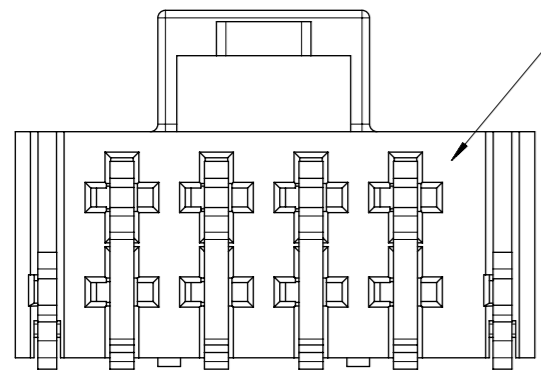







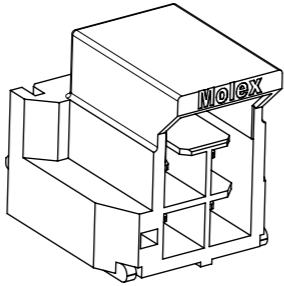
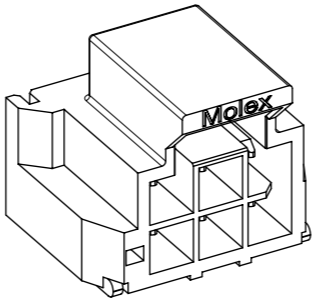
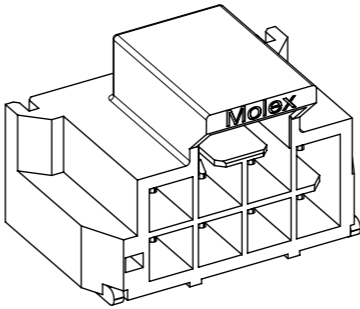
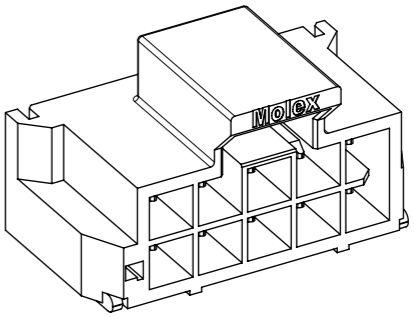
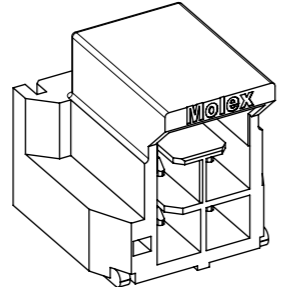
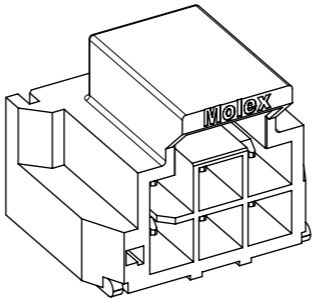
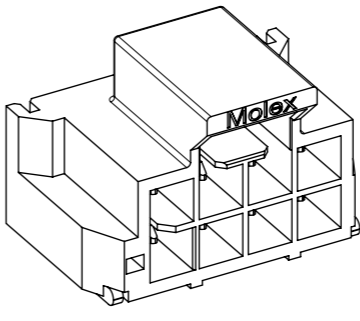
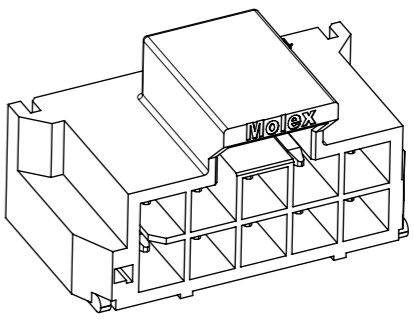
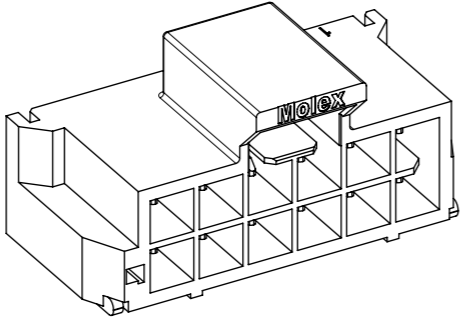
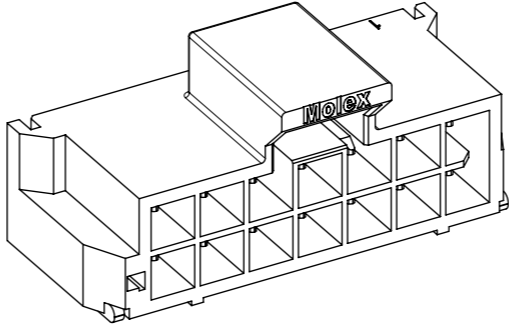
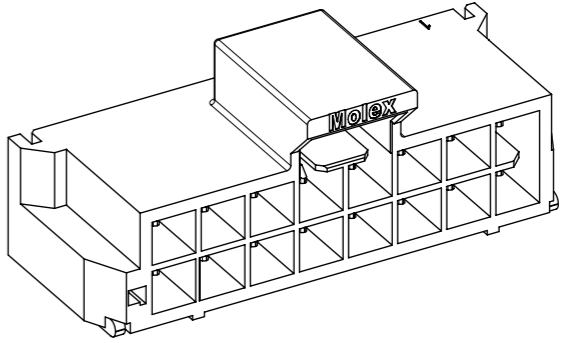
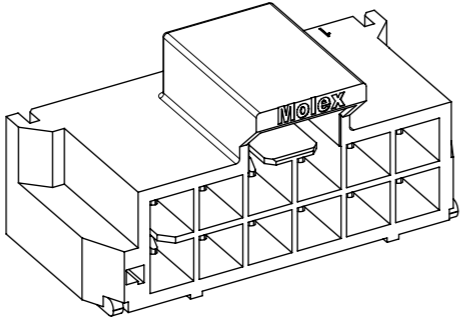
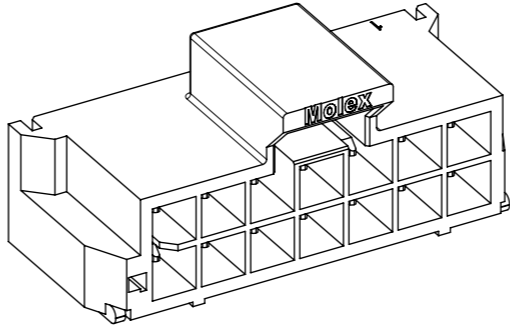
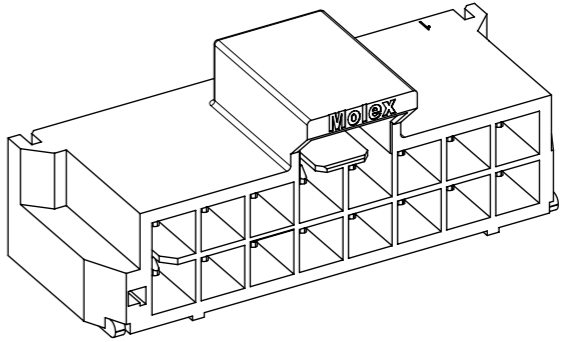

IF ANY NUMBER MARK APPEARS ON THIS SURFACE, PLEASE DISREGARD IT, IT IS NO ANY FUCTION AND NO ANY RELATION TO PIN NUMBER, IT IS JUST FOR MOLDING IDENDIFICATION.

THIS DRAWING CONTAINS INFORMATION THAT IS PROPRIETARY TO MOLEX ELECTRONIC TECHNOLOGIES, LLC AND SHOULD NOT BE USED WITHOUT WRITTEN PERMISSION

QUALITY SYMBOLS FA = 0 FB = 0 FC = 0 FD = 0 FE = 0 FF = 0 FG = 0 FH = 0 FI = 0 FJ = 0 FK = 0 FL = 0	DRW: GLLI CHK'D: YXZHENG APPR: YXZHENG DATE: 2019/10/10 REV:	GENERAL TOLERANCES (UNLESS SPECIFIED) ANGULAR TOL ± 3.0 ° 4 PLACES ± 3 PLACES ± 2 PLACES ± 0.2 1 PLACE ± 0.3 0 PLACES ±	DIMENSION UNITS: mm SCALE: 5:1 DRWN BY: RFC_PLMMW DATE: 2016/01/04 CHK'D BY: DATE: APPR BY: AYIN DATE: 2016/01/04 DRAWING SIZE: A3 THIRD ANGLE PROJECTION			
	SD DRAWING FOR SMT HEADER OF NANO-FIT RA DUAL					
	PRODUCT CUSTOMER DRAWING				SERIES: 105405	MATERIAL NUMBER:
	DOCUMENT NUMBER: SD-105405-001			DOC TYPE: PSD	DOC PART: 000	SHEET NUMBER: 3 OF 4
	DRAWING SIZE: A3			CUSTOMER: GENERAL MARKET		

	4 CKT	6 CKT	8 CKT	10 CKT
BLACK				
NATURAL				
	12 CKT	14 CKT	16 CKT	
BLACK				
NATURAL				

THIS DRAWING CONTAINS INFORMATION THAT IS PROPRIETARY TO MOLEX ELECTRONIC TECHNOLOGIES, LLC AND SHOULD NOT BE USED WITHOUT WRITTEN PERMISSION											
QUALITY SYMBOLS  = 0  = 0  = 0  = 0  = 0  = 0  = 0		2019/10/10 2019/10/10 2019/10/10		GENERAL TOLERANCES (UNLESS SPECIFIED) ANGULAR TOL ± 3.0 ° 4 PLACES ± 3 PLACES ± 2 PLACES ± 0.2 1 PLACE ± 0.3 0 PLACES ±		DIMENSION UNITS: mm SCALE: 3:1		 SD DRAWING FOR SMT HEADER OF NANO-FIT RA DUAL		DRWN BY: RFC_PLMMW DATE: 2016/01/04	
EC NO: 625433 DRWN: GLLI CHK'D: YXZHENG APPR: YXZHENG		DRAFT WHERE APPLICABLE MUST REMAIN WITHIN DIMENSIONS		DRWING SIZE: A3 THIRD ANGLE PROJECTION		CHK'D BY: AYIN DATE: 2016/01/04				PRODUCT CUSTOMER DRAWING	
RELEASE STATUS: P1 RELEASE DATE: 2019/10/10 06:03:13		DOCUMENT NUMBER: SD-105405-001 DOC TYPE: PSD DOC PART: 000 SHEET NUMBER: 4 OF 4									