

Dual Supply, 2-Bit Voltage Translator / Buffer / Repeater / Isolator for I²C Applications

FXMA2102



UQFN8, 1.4x1.2, 0.4P
CASE 523AS



UQFN8 1.6X1.6, 0.5P
CASE 523AY

Description

The FXMA2102 is a high-performance configurable dual-voltage-supply translator for bi-directional voltage translation over a wide range of input and output voltages levels.

Intended for use as a voltage translator between I²C-Bus compliant masters and slaves.

The device is designed so that the A port tracks the V_{CCA} level and the B port tracks the V_{CCB} level. This allows for bi-directional A/B port voltage translation between any two levels from 1.65 V to 5.5 V. V_{CCA} can equal V_{CCB} from 1.65 V to 5.5 V. The OE pin is referenced to V_{CCA}.

Either V_{CC} can be powered-up first. Internal power-down control circuits place the device in 3-state if either V_{CC} is removed.

The two ports of the device have automatic direction sense capability. Either port may sense an input signal and transfer it as an output signal to the other port.

Features

- Bi-Directional Interface between Any Two Levels: 1.65 V to 5.5 V
- Direction Control not Needed
- System GPIO Resources Not Required when OE Tied to V_{CCA}
- I²C 400 pF Buffer / Repeater
- I²C Bus Isolation
- A/B Port V_{OL} = 175 mV (Typical), V_{IL} = 150 mV, I_{OL} = 6 mA
- Open-Drain Inputs / Outputs
- Accommodates Standard-Mode and Fast-Mode I²C-Bus Devices
- Supports I²C Clock Stretching & Multi-Master
- Fully Configurable: Inputs and Outputs Track V_{CC}
- Control Input (OE) Referenced to V_{CCA}.
- Non-Preferential Power-Up; Either V_{CC} May Be Powered-Up First
- Outputs Switch to 3-State if Either V_{CC} is at GND
- Tolerant Output Enable: 5 V
- Packaged in 8-Terminal Leadless MicroPak™ (1.6 mm x 1.6 mm) and Ultrathin MLP (1.2 mm x 1.4 mm)
- ESD Protection Exceeds:
 - ◆ 8 kV HBM ESD (per JESD22-A114)
 - ◆ 2 kV CDM (per JESD22-C101)

MARKING DIAGRAM

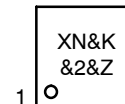

- XN = Device Code
- &K = 2-Digits Lot Run Traceability Code
- &2 = 2-Digit Date Code
- &Z = Assembly Plant Code

ORDERING INFORMATION

See detailed ordering and shipping information on page 13 of this data sheet.

FXMA2102

BLOCK DIAGRAM

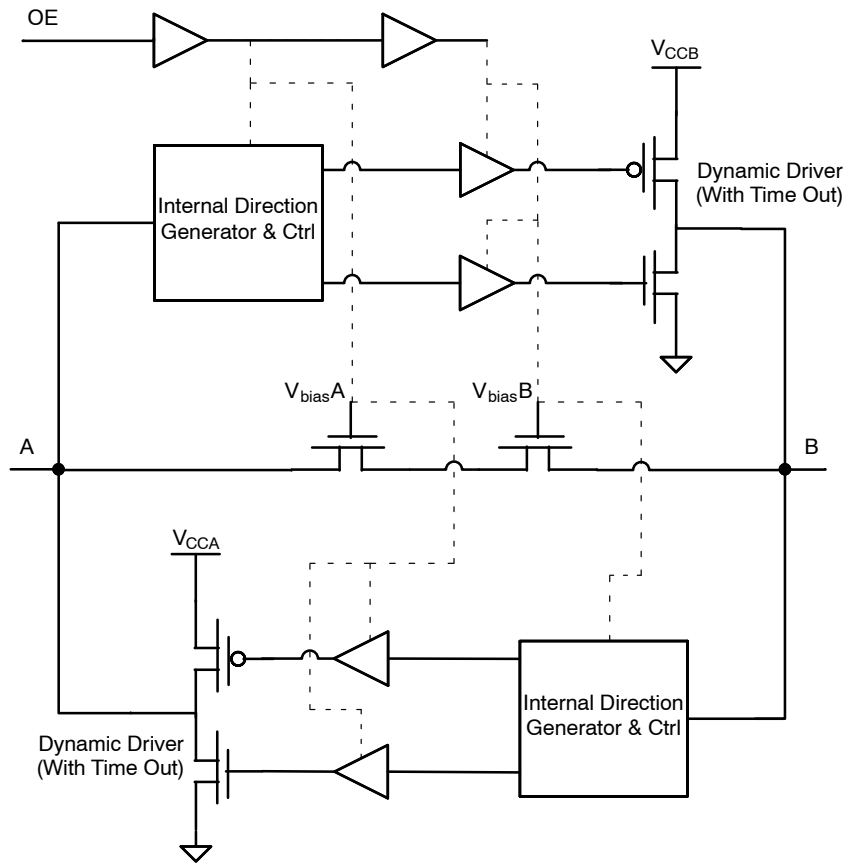

Figure 1. Block Diagram, 1 of 2 Channels

FXMA2102

PIN CONFIGURATION

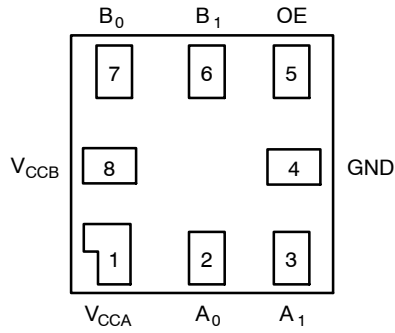

Figure 2. MicroPak (Top-Through View)

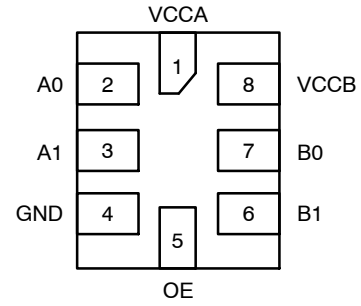

Figure 3. UMLP (Top-Through View)

PIN DEFINITIONS

Pin No.	Name	Description
1	V _{CCA}	A-Side Power Supply
2, 3	A ₀ , A ₁	A-Side Inputs or 3-State Outputs
4	GND	Ground
5	OE	Output Enable Input (Referenced to V _{CCA})
6, 7	B ₁ , B ₀	B-Side Inputs or 3-State Outputs
8	V _{CCB}	B-Side Power Supply

TRUTH TABLE

Control	Outputs
OE	
LOW Logic Level	3-State
HIGH Logic Level	Normal Operation

1. If the OE pin is driven LOW, the FXMA2102 is disabled and the A₀, A₁, B₀, and B₁ pins (including dynamic drivers) are forced into 3-state.

FXMA2102

ABSOLUTE MAXIMUM RATINGS

Symbol	Parameter		Min	Max	Unit
V_{CCA}, V_{CCB}	Supply Voltage		-0.5	7.0	V
V_{IN}	DC Input Voltage	A Port	-0.5	7.0	V
		B Port	-0.5	7.0	
		Control Input (OE)	-0.5	7.0	
V_O	Output Voltage (Note 2)	A_n Outputs 3-State	-0.5	7.0	V
		B_n Outputs 3-State	-0.5	7.0	
		A_n Outputs Active	-0.5	$V_{CCA} + 0.5\text{ V}$	
		B_n Outputs Active	-0.5	$V_{CCB} + 0.5\text{ V}$	
I_{IK}	DC Input Diode Current	At $V_{IN} < 0\text{ V}$	-	-50	mA
I_{OK}	DC Output Diode Current	At $V_O < 0\text{ V}$	-	-50	mA
		At $V_O > V_{CC}$	-	+50	
I_{OH} / I_{OL}	DC Output Source/Sink Current		-50	+50	mA
I_{CC}	DC V_{CC} or Ground Current per Supply Pin		-	± 100	mA
P_D	Power Dissipation	At 400 KHz	-	0.129	mW
T_{STG}	Storage Temperature Range		-65	+150	$^{\circ}\text{C}$
ESD	Electrostatic Discharge Capability	Human Body Model, JESD22-A114	-	8	kV
		Charged Device Mode, JESD22-C101	-	2	

Stresses exceeding those listed in the Maximum Ratings table may damage the device. If any of these limits are exceeded, device functionality should not be assumed, damage may occur and reliability may be affected.

2. I_O absolute maximum rating must be observed.

RECOMMENDED OPERATING CONDITIONS

Symbol	Parameter		Min	Max	Unit
V_{CCA}, V_{CCB}	Power Supply Operating		1.65	5.50	V
V_{IN}	Input Voltage	A Port	0	5.5	V
		B Port	0	5.5	
		Control Input (OE)	0	V_{CCA}	
Θ_{JA}	Thermal Resistance	8-Lead MicroPak	-	279.0	$^{\circ}\text{C}/\text{W}$
		8-Lead Ultrathin MLP	-	301.5	
T_A	Free Air Operating Temperature		-40	+85	$^{\circ}\text{C}$

Functional operation above the stresses listed in the Recommended Operating Ranges is not implied. Extended exposure to stresses beyond the Recommended Operating Ranges limits may affect device reliability.

3. All unused inputs and I/O pins must be held at V_{CCI} or GND

FUNCTIONAL DESCRIPTION

Power-Up/Power-Down Sequencing

FXM translators offer an advantage in that either V_{CC} may be powered up first. This benefit derives from the chip design. When either V_{CC} is at 0 V, outputs are in a high-impedance state. The control input (OE) is designed to track the V_{CCA} supply. A pull-down resistor tying OE to GND should be used to ensure that bus contention, excessive currents, or oscillations do not occur during power-up/power-down. The size of the pull-down resistor is based upon the current-sinking capability of the device driving the OE pin.

The recommended power-up sequence is:

1. Apply power to the first V_{CC} .
2. Apply power to the second V_{CC} .
3. Drive the OE input HIGH to enable the device.

The recommended power-down sequence is:

1. Drive OE input LOW to disable the device.
2. Remove power from either V_{CC} .
3. Remove power from other V_{CC} .

NOTE:

4. Alternatively, the OE pin can be hardwired to V_{CCA} to save GPIO pins. If OE is hardwired to V_{CCA} , either V_{CC} can be powered up or down first.

APPLICATION CIRCUIT

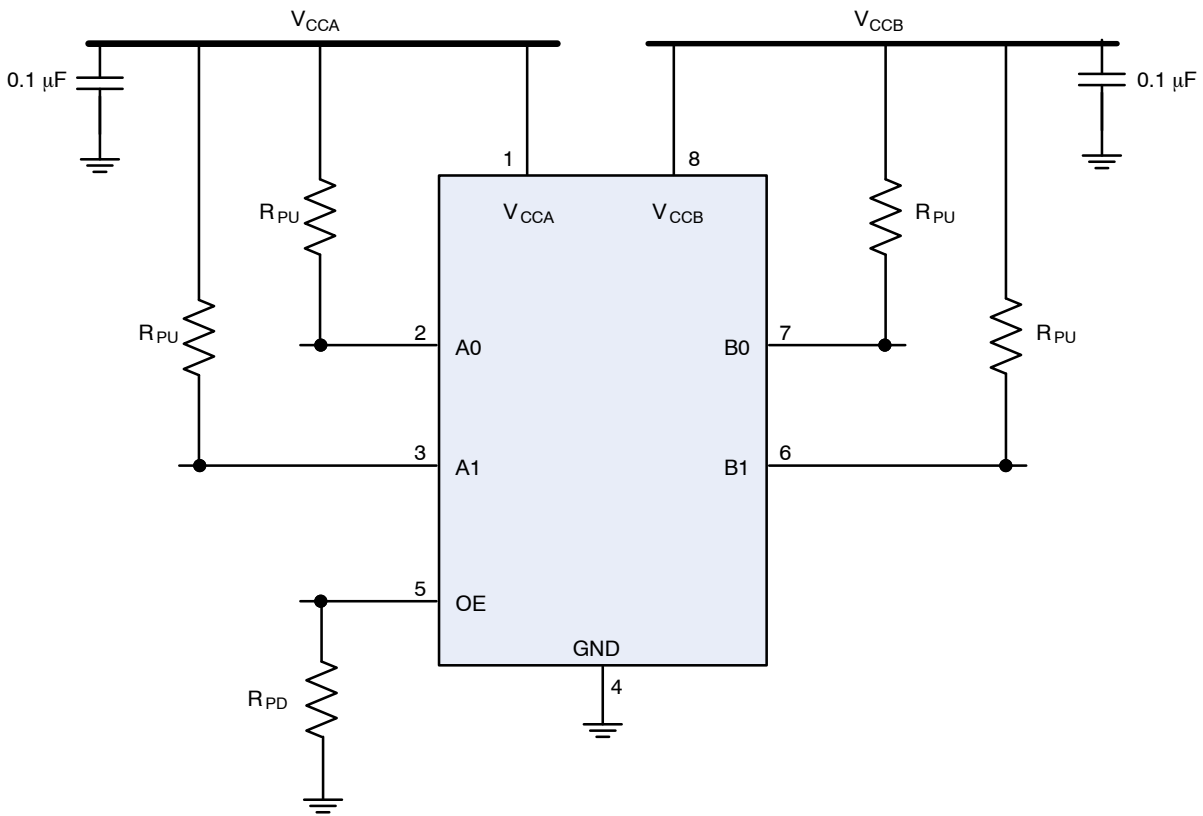

Figure 4. Application Circuit

APPLICATION NOTES

The FXMA2102 has open-drain I/Os and requires external pull-up resistors on the four data I/O pins, as shown in Figure 4. If a pair of data I/O pins (A_n/B_n) is not used, both pins should be tied to GND (or both to V_{CC}). In this case, pull-down or pull-up resistors are not required. The recommended values for the pull-up resistors (RPU) are 1 k Ω to 10 k Ω ; however, depending on the total bus capacitance, the user is free to vary the pull-up resistor value to meet the maximum I²C edge rate per the I²C specification (UM10204 rev. 03, June 19, 2007). For example, the maximum edge rate (30% – 70%) during fast mode (400 kbit/s) is 300 ns. If bus capacitance is approaching the maximum 400 pF, lower the RPU value to keep the rise time below 300 ns (Fast Mode). Section 7.1 of the I²C specification provides an excellent guideline for pull-up resistor sizing.

Theory of Operation

The FXMA2102 is designed for high-performance level shifting and buffer / repeating in an I²C application. Figure 1 shows that each bi-directional channel contains two series-Npassgates and two dynamic drivers. This hybrid architecture is highly beneficial in an I²C application where auto-direction is a necessity.

For example, during the following three I²C protocol events:

- Clock Stretching
- Slave's ACK Bit (9th bit = 0) following a Master's Write Bit (8th bit = 0)
- Clock Synchronization and Multi Master Arbitration

The bus direction needs to change from master to slave to slave to master without the occurrence of an edge. If there is an I²C translator between the master and slave in these examples, the I²C translator must change direction when both A and B ports are LOW. The Npassgates can accomplish this task very efficiently because, when both A and B ports are LOW, the Npassgates act as a low resistive short between the two (A and B) ports.

Due to I²C's open-drain topology, I²C masters and slaves are not push/pull drivers. Logic LOWs are “pulled down” (I_{sink}), while logic HIGHs are “let go” (3–state). For example, when the master lets go of SCL (SCL always comes from the master), the rise time of SCL is largely determined by the RC time constant, where $R = R_{PU}$ and $C =$ the bus capacitance. If the FXMA2102 is attached to the master [on the A port] in this example, and there is a slave on the B port, the Npassgates act as a low resistive short between both ports until either of the port's $V_{CC}/2$ thresholds are reached. After the RC time constant has reached the $V_{CC}/2$ threshold of either port, the port's edge detector triggers both dynamic drivers to drive their respective ports in the LOW-to-HIGH (LH) direction, accelerating the rising edge. The resulting rise time resembles the scope shot in Figure 5. Effectively, two

distinct slew rates appear in rise time. The first slew rate (slower) is the RC time constant of the bus. The second slew rate (much faster) is the dynamic driver accelerating the edge.

If both the A and B ports of the translator are HIGH, a high-impedance path exists between the A and B ports because both the Npassgates are turned off. If a master or slave device decides to pull SCL or SDA LOW, that device's driver pulls down (I_{sink}) SCL or SDA until the edge reaches the A or B port $V_{CC}/2$ threshold. When either the A or B port threshold is reached, the port's edge detector triggers both dynamic drivers to drive their respective ports in the HIGH-to-LOW (HL) direction, accelerating the falling edge.

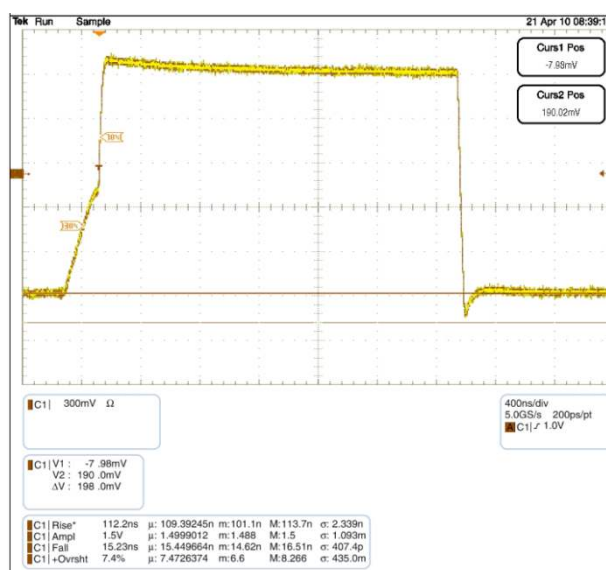

Figure 5. FXMA2102 Waveform C: 600 pF, R_{PU}: 2.2 K

Buffer / Repeater Performance

The FXMA2102 dynamic drivers have enough current sourcing capability to drive a 400 pF capacitive bus. This is beneficial for instances when an I²C buffer / repeater is required. The I²C specification stipulates a maximum bus capacitance of 400 pF. If an I²C segment exceeds 400 pF, an I²C buffer / repeater is required to split the segment into two segments, each of which is less than 400 pF. Figure 5 is a scope shot of an FXMA2102 driving a lumped load of 600 pF. Notice the (30% – 70%) rise time is only 112 ns ($R_{PU} = 2.2$ K). This is well below the maximum edge rate of 300 ns. Not only does the FXMA2102 drive 400 pF, but it also provides excellent headroom below the I²C specification maximum edge rate of 300 ns.

V_{OL} vs. I_{OL}

The I²C specification mandates a maximum V_{IL} (I_{OL} of 3 mA) of $V_{CC} \cdot 0.3$ and a maximum V_{OL} of 0.4 V. If there is a master on the A port of an I²C translator with a V_{CC} of

FXMA2102

1.65 V and a slave on the I²C translator B port with a V_{CC} of 3.3 V, the maximum V_{IL} of the master is (1.65 V x 0.3) 495 mV. The slave could legally transmit a valid logic LOW of 0.4 V to the master.

If the I²C translator's channel resistance is too high, the voltage drop across the translator could present a V_{IL} to the master greater than 495 mV. To complicate matters, the I²C

specification states that 6 mA of I_{OL} is recommended for bus capacitances approaching 400 pF. More I_{OL} increases the voltage drop across the I²C translator. The I²C application benefits when I²C translators exhibit low V_{OL} performance. Figure 6 depicts typical FXMA2102 V_{OL} performance vs. the competition, given a 0.4 V V_{IL}.

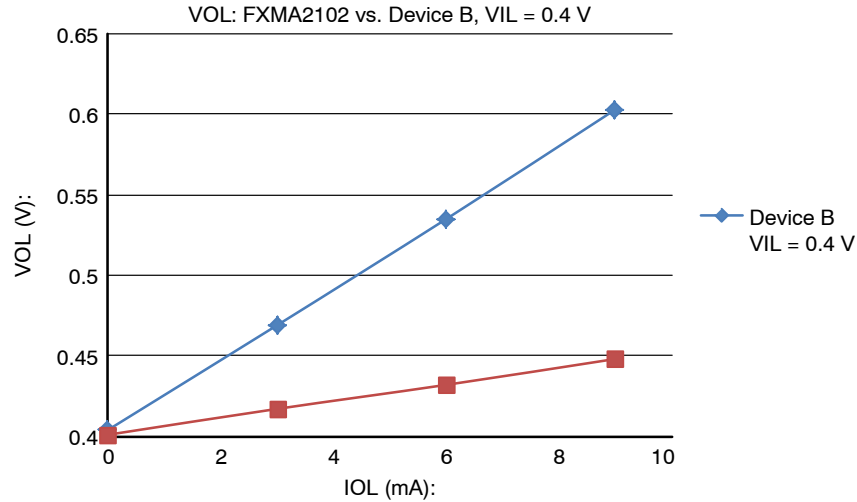

Figure 6. V_{OL} vs. I_{OL}

I²C-Bus Isolation

The FXMA2102 supports I²C-Bus isolation for the following conditions:

- Bus isolation if bus clear
- Bus isolation if either V_{CC} goes to ground

Bus Clear

Because the I²C specification defines the minimum SCL frequency of DC, the SCL signal can be held LOW forever; however, this condition shuts down the I²C bus. The I²C specification refers to this condition as “Bus Clear”. In Figure 7, if slave #2 holds down SCL forever, the master and slave #1 are not able to communicate, because the FXMA2102 passes the SCL stuck-LOW condition from

slave #2 to slave #1 as well as the master. However, if the OE pin is pulled LOW (disabled), both ports (A and B) are 3-stated. This results in the FXMA2102 isolating slave #2 from the master and slave #1, allowing full communication between the master and slave #1.

Either V_{CC} to GND

If slave #2 is a camera that is suddenly removed from the I²C bus, resulting in V_{CCB} transitioning from a valid V_{CC} (1.65 V – 5.5 V) to 0 V, the FXMA2102 automatically forces SCL and SDA on both its A and B ports into 3-state. Once V_{CCB} has reached 0 V, full I²C communication between the master and slave #1 remains undisturbed.

FXMA2102

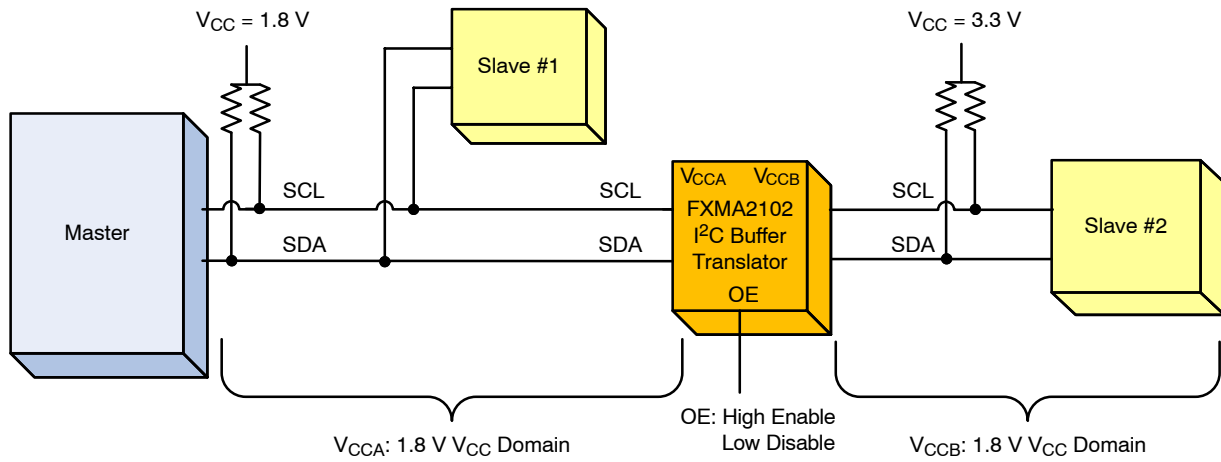

Figure 7. Bus Isolation

DC ELECTRICAL CHARACTERISTICS ($T_A = -40^\circ\text{C}$ to $+85^\circ\text{C}$)

Symbol	Parameter	Condition	V_{CCA} (V)	V_{CCB} (V)	Min	Max	Unit
V_{IHA}	High Level Input Voltage A	Data Inputs A_n	1.65 – 5.50	1.65 – 5.50	$V_{CCA} - 0.4$	–	V
		Control Input OE	1.65 – 5.50	1.65 – 5.50	$0.7 \times V_{CCA}$	–	
V_{IHB}	High Level Input Voltage B	Data Inputs B_n	1.65 – 5.50	1.65 – 5.50	$V_{CCB} - 0.4$	–	V
V_{ILA}	Low Level Input Voltage A	Data Inputs A_n	1.65 – 5.50	1.65 – 5.50	–	0.4	V
		Control Input OE	1.65 – 5.50	1.65 – 5.50	–	$0.3 \times V_{CCA}$	
V_{ILB}	Low Level Input Voltage B	Data Inputs B_n	1.65 – 5.50	1.65 – 5.50	–	0.4	V
V_{OL}	Low Level Output Voltage	$V_{IL} = 0.15\text{ V}$	1.65–5.50	1.65–5.50	–	0.4	V
		$I_{OL} = 6\text{ mA}$					
I_L	Input Leakage Current	Control Input OE, $V_{IN} = V_{CCA}$ or GND	1.65 – 5.50	1.65 – 5.50	–	± 1.0	μA
I_{OFF}	Power Off Leakage Current	A_n V_{IN} or $V_O = 0\text{ V}$ to 5.5 V	0	5.50	–	± 2.0	μA
		B_n V_{IN} or $V_O = 0\text{ V}$ to 5.5 V	5.50	0	–	± 2.0	
I_{OZ}	3–State Output Leakage (Note 6)	A_n, B_n $V_O = 0\text{ V}$ to 5.5 V , OE = V_{IL}	5.50	5.50	–	± 2.0	μA
		A_n $V_O = 0\text{ V}$ to 5.5 V , OE = Don't Care	5.50	0	–	± 2.0	
		B_n $V_O = 0\text{ V}$ to 5.5 V , OE = Don't Care	0	5.50	–	± 2.0	
$I_{CCA/B}$	Quiescent Supply Current (Note 7, 8)	$V_{IN} = V_{CC1}$ or GND, $I_O = 0$	1.65 – 5.50	1.65 – 5.50	–	5.0	μA
I_{CCZ}	Quiescent Supply Current (Note 7)	$V_{IN} = V_{CC1}$ or GND, $I_O = 0$, OE = V_{IL}	1.65 – 5.50	1.65 – 5.50	–	5.0	μA
I_{CCA}	Quiescent Supply Current (Note 6)	$V_{IN} = 5.5\text{ V}$ or GND, $I_O = 0$, OE = Don't Care, B_n to A_n	0	1.65 – 5.50	–	–2.0	μA
			1.65 – 5.50	0	–	2.0	
I_{CCB}	Quiescent Supply Current (Note 6)	$V_{IN} = 5.5\text{ V}$ or GND, $I_O = 0$, OE = Don't Care, A_n to B_n	1.65 – 5.50	0	–	–2.0	μA
			0	1.65 – 5.50	–	2.0	

5. This table contains the output voltage for static conditions. Dynamic drive specifications are given in Dynamic Output Electrical Characteristics.

6. "Don't Care" indicates any valid logic level.

7. V_{CC1} is the V_{CC} associated with the input side.

8. Reflects current per supply, V_{CCA} or V_{CCB} .

FXMA2102

DYNAMIC OUTPUT ELECTRICAL CHARACTERISTICS

OUTPUT RISE / FALL TIME (Output load: $C_L = 50$ pF, $R_{PU} = 2.2$ k Ω , push / pull driver, and $T_A = -40^\circ\text{C}$ to $+85^\circ\text{C}$.)

Symbol	Parameter	V_{CCO} (Note 10)				Unit
		4.5 to 5.5 V	3.0 to 3.6 V	2.3 to 2.7 V	1.65 to 1.95 V	
		Typ	Typ	Typ	Typ	
t_{rise}	Output Rise Time; A Port, B Port (Note 11)	3	4	5	7	ns
t_{fall}	Output Fall Time; A Port, B Port (Note 12)	1	1	1	1	ns

9. Output rise and fall times guaranteed by design simulation and characterization; not production tested.

10. V_{CCO} is the V_{CC} associated with the output side.

11. See Figure 12.

12. See Figure 13.

DYNAMIC OUTPUT ELECTRICAL CHARACTERISTICS

MAXIMUM DATA RATE (Note 13) (Output load: $C_L = 50$ pF, $R_{PU} = 2.2$ k Ω , push / pull driver, and $T_A = -40^\circ\text{C}$ to $+85^\circ\text{C}$.)

V_{CCA}	Direction	V_{CCB}				Unit
		4.5 to 5.5 V	3.0 to 3.6 V	2.3 to 2.7 V	1.65 to 1.95 V	
		Min	Min	Min	Min	
4.5 V to 5.5 V	A to B	37	26	19	10	MHz
	B to A	37	36	35	32	
3.0 V to 3.6 V	A to B	36	25	18	10	MHz
	B to A	25	25	25	24	
2.3 V to 2.7 V	A to B	35	25	18	10	MHz
	B to A	18	18	18	17	
1.65 V to 1.95 V	A to B	32	24	17	10	MHz
	B to A	10	10	10	10	

13. F-toggle guaranteed by design simulation; not production tested.

FXMA2102

AC CHARACTERISTICS (Output load: $C_L = 50$ pF, $R_{PU} = 2.2$ k Ω , and $T_A = -40^\circ\text{C}$ to $+85^\circ\text{C}$.)

Symbol	Parameter	V_{CCB}								Unit
		4.5 to 5.5 V		3.0 to 3.6 V		2.3 to 2.7 V		1.65 to 1.95 V		
		Typ	Max	Typ	Max	Typ	Max	Typ	Max	

$V_{CCA} = 4.5$ to 5.5 V

t_{PLH}	A to B	1	3	1	3	1	3	1	3	ns
	B to A	1	3	2	4	3	5	4	7	
t_{PHL}	A to B	2	4	3	5	4	6	5	7	ns
	B to A	2	4	2	5	2	6	5	7	
t_{PZL}	OE to A	4	5	6	10	5	9	7	15	ns
	OE to B	3	5	4	7	5	8	10	15	
t_{PLZ}	OE to A	65	100	65	105	65	105	65	105	ns
	OE to B	5	9	6	10	7	12	9	16	
t_{skew}	A Port, B Port (Note 14)	0.50	1.50	0.50	1.00	0.50	1.00	0.50	1.00	ns

$V_{CCA} = 3.0$ to 3.6 V

t_{PLH}	A to B	2.0	5.0	1.5	3.0	1.5	3.0	1.5	3.0	ns
	B to A	1.5	3.0	1.5	4.0	2.0	6.0	3.0	9.0	
t_{PHL}	A to B	2.0	4.0	2.0	4.0	2.0	5.0	3.0	5.0	ns
	B to A	2.0	4.0	2.0	4.0	2.0	5.0	3.0	5.0	
t_{PZL}	OE to A	4.0	8.0	5.0	9.0	6.0	11.0	7.0	15.0	ns
	OE to B	4.0	8.0	6.0	9.0	8.0	11.0	10.0	14.0	
t_{PLZ}	OE to A	100	115	100	115	100	115	100	115	ns
	OE to B	5	10	4	8	5	10	9	15	
t_{skew}	A Port, B Port (Note 14)	0.5	1.5	0.5	1.0	0.5	1.0	0.5	1.0	ns

$V_{CCA} = 2.3$ to 2.7 V

t_{PLH}	A to B	2.5	5.0	2.5	5.0	2.0	4.0	1.0	3.0	ns
	B to A	1.5	3.0	2.0	4.0	3.0	6.0	5.0	10.0	
t_{PHL}	A to B	2.0	5.0	2.0	5.0	2.0	5.0	3.0	6.0	ns
	B to A	2.0	5.0	2.0	5.0	2.0	5.0	3.0	6.0	
t_{PZL}	OE to A	5.0	10.0	5.0	10.0	6.0	12.0	9.0	18.0	ns
	OE to B	4.0	8.0	4.5	9.0	5.0	10.0	9.0	18.0	
t_{PLZ}	OE to A	100	115	100	115	100	115	100	115	ns
	OE to B	65	110	65	110	65	115	12	25	
t_{skew}	A Port, B Port (Note 14)	0.5	1.5	0.5	1.0	0.5	1.0	0.5	1.0	ns

$V_{CCA} = 1.65$ to 1.95 V

t_{PLH}	A to B	4	7	4	7	5	8	5	10	ns
	B to A	1.0	2.0	1.0	2.0	1.5	3.0	5.0	10.0	
t_{PHL}	A to B	5	8	3	7	3	7	3	7	ns
	B to A	4	8	3	7	3	7	3	7	
t_{PZL}	OE to A	11	15	11	14	14	28	14	23	ns
	OE to B	6	14	6	12	6	12	9	16	
t_{PLZ}	OE to A	75	115	75	115	75	115	75	115	ns
	OE to B	75	115	75	115	75	115	75	115	
t_{skew}	A Port, B Port (Note 14)	0.5	1.5	0.5	1.0	0.5	1.0	0.5	1.0	ns

14. Skew is the variation of propagation delay between output signals and applies only to output signals on the same port (A_n or B_n) and switching with the same polarity (LOW-to-HIGH or HIGH-to-LOW) (see Figure 15). Skew is guaranteed, but not tested.

FXMA2102

CAPACITANCE ($T_A = +25^\circ\text{C}$)

Symbol	Parameter	Condition	Typ	Unit
C_{IN}	Input Capacitance Control Pin (OE)	$V_{CCA} = V_{CCB} = \text{GND}$	2.2	pF
$C_{I/O}$	Input/Output Capacitance, A_n, B_n	$V_{CCA} = V_{CCB} = 5.0 \text{ V}$, $\text{OE} = \text{GND}$, $V_A = V_B = 5.0 \text{ V}$	13.0	pF
C_{pd}	Power Dissipation Capacitance	$V_{CCA} = V_{CCB} = 5.0 \text{ V}$, $V_{IN} = 0 \text{ V}$ or V_{CC} , $f = 400 \text{ KHz}$	13.5	pF

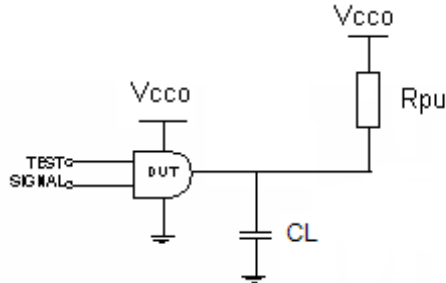

Figure 8. AC Test Circuit

Table 1. PROPAGATION DELAY TABLE

Test	Input Signal	Output Enable Control
t_{PLH}, t_{PHL}	Data Pulses	V_{CCA}
t_{PZL} (OE to A_n, B_n)	0 V	LOW to HIGH Switch
t_{PLZ} (OE to A_n, B_n)	0 V	HIGH to LOW Switch

Table 2. AC LOAD TABLE

V_{CCO}	C_L	R_L
$1.8 \pm 0.15 \text{ V}$	50 pF	2.2 k Ω
$2.5 \pm 0.2 \text{ V}$	50 pF	2.2 k Ω
$3.3 \pm 0.3 \text{ V}$	50 pF	2.2 k Ω
$5.0 \pm 0.5 \text{ V}$	50 pF	2.2 k Ω

TIMING DIAGRAMS

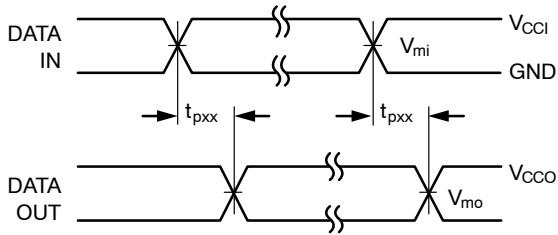

Figure 9. Waveform for Inverting and Non-Inverting Functions (Note 15)

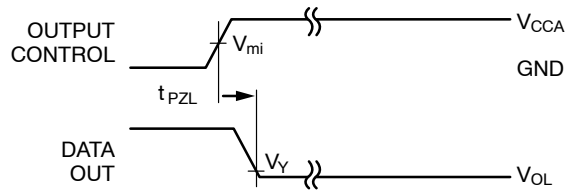

Figure 10. 3-STATE Output Low Enable Time (Note 15)

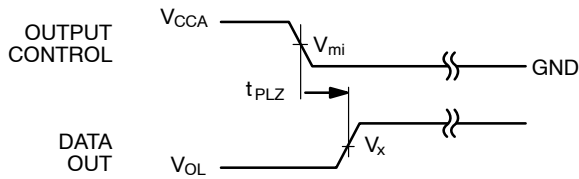

Figure 11. 3-STATE Output High Enable Time (Note 15)

Symbol	V _{CC}
V _{mi} (Note 16)	V _{CCI} / 2
V _{mo}	V _{CCO} / 2
V _X	0.5 × V _{CCO}
V _Y	0.1 × V _{CCO}

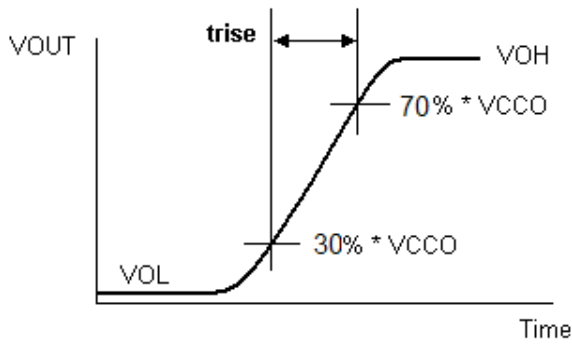

Figure 12. Active Output Rise Time

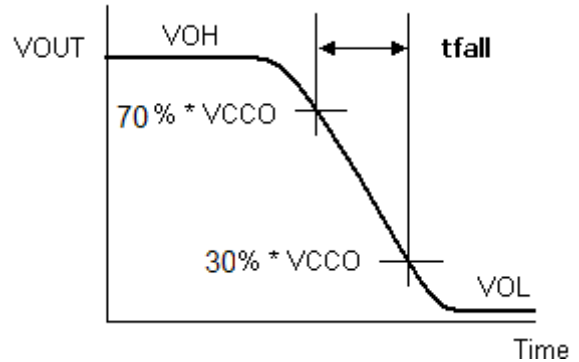

Figure 13. Active Output Fall Time

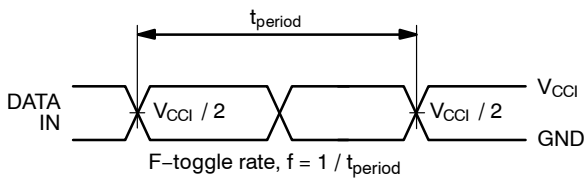

Figure 14. F-Toggle Rate

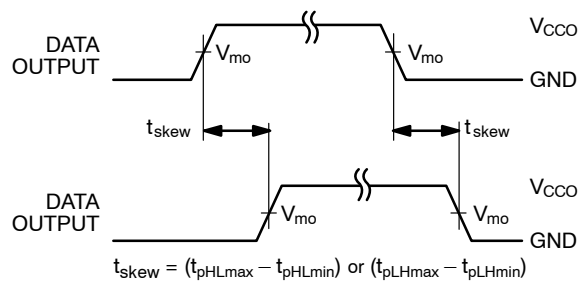

Figure 15. Output Skew Time

NOTES:

- 15. Input $t_R = t_F = 2.0$ ns, 10% to 90% at $V_{IN} = 1.65$ V to 1.95 V;
 Input $t_R = t_F = 2.0$ ns, 10% to 90% at $V_{IN} = 2.3$ V to 2.7 V;
 Input $t_R = t_F = 2.5$ ns, 10% to 90%, at $V_{IN} = 3.0$ V to 3.6 V only;
 Input $t_R = t_F = 2.5$ ns, 10% to 90%, at $V_{IN} = 4.5$ V to 5.5 V only.
- 16. $V_{CCI} = V_{CCA}$ for control pin OE or $V_{mi} = (V_{CCA} / 2)$.

FXMA2102

ORDERING INFORMATION

Part Number	Operating Temperature Range	Top Mark	Package	Packing Method [†]
FXMA2102L8X	-40 to +85°C	XN	8-Lead MicroPak, 1.6 mm Wide (Pb-Free)	5000 / Tape & Reel
FXMA2102UMX			8-Lead Ultrathin MLP, 1.2 mm x 1.4 mm (Pb-Free)	

[†]For information on tape and reel specifications, including part orientation and tape sizes, please refer to our Tape and Reel Packaging Specifications Brochure, BRD8011/D.

MicroPak is trademark of Semiconductor Components Industries, LLC (SCILLC) or its subsidiaries in the United States and/or other countries.
onsemi is licensed by the Philips Corporation to carry the I²C bus protocol.

MECHANICAL CASE OUTLINE PACKAGE DIMENSIONS



SCALE 4:1

UQFN8, 1.40x1.20, 0.40P
CASE 523AS
ISSUE B

DATE 19 AUG 2021

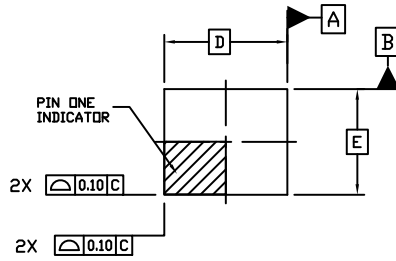

TOP VIEW

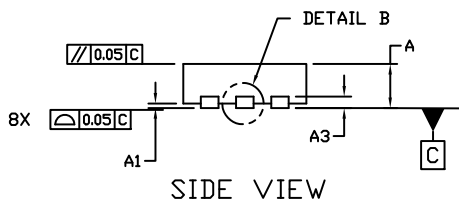

SIDE VIEW

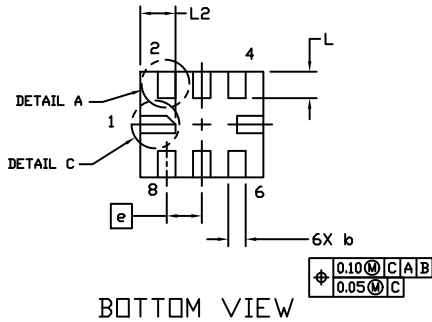

BOTTOM VIEW

GENERIC MARKING DIAGRAM*



XX = Specific Device Code
M = Date Code

*This information is generic. Please refer to device data sheet for actual part marking. Pb-Free indicator, "G" or microdot "▪", may or may not be present. Some products may not follow the Generic Marking.

NOTES:

1. DIMENSIONING AND TOLERANCING PER ASME Y14.5M, 1994.
2. CONTROLLING DIMENSION: MILLIMETERS
3. DIMENSION b APPLIES TO PLATED TERMINAL AND IS MEASURED BETWEEN 0.15 AND 0.25MM FROM THE TERMINAL TIP.
4. REFER TO SPECIFIC DEVICE DATA SHEET FOR PIN 1 NOTCH LOCATION.

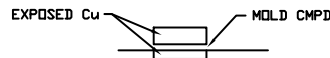

DETAIL B
ALTERNATE CONSTRUCTION

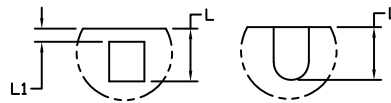

DETAIL A
ALTERNATE CONSTRUCTIONS



DETAIL C
ALTERNATE CONSTRUCTION
NOTE 4

DIM	MILLIMETERS	
	MIN.	MAX.
A	0.45	0.55
A1	0.00	0.05
A3	0.13	REF
b	0.15	0.25
D	1.40	BSC
E	1.20	BSC
e	0.40	BSC
L	0.20	0.40
L1	---	0.15
L2	0.30	0.50

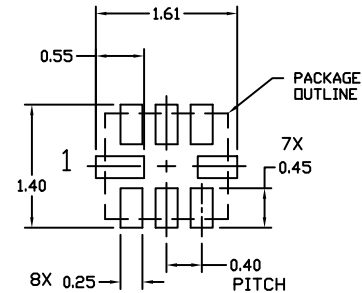

RECOMMENDED MOUNTING FOOTPRINT *

* For additional information on our Pb-Free strategy and soldering details, please download the QFN Semiconductor Soldering and Mounting Techniques Reference Manual, SOLDERRM/D.

DOCUMENT NUMBER:	98AON58906E	Electronic versions are uncontrolled except when accessed directly from the Document Repository. Printed versions are uncontrolled except when stamped "CONTROLLED COPY" in red.
DESCRIPTION:	UQFN8, 1.40x1.20, 0.40P	PAGE 1 OF 1

onsemi and ONSEMI are trademarks of Semiconductor Components Industries, LLC dba onsemi or its subsidiaries in the United States and/or other countries. onsemi reserves the right to make changes without further notice to any products herein. onsemi makes no warranty, representation or guarantee regarding the suitability of its products for any particular purpose, nor does onsemi assume any liability arising out of the application or use of any product or circuit, and specifically disclaims any and all liability, including without limitation special, consequential or incidental damages. onsemi does not convey any license under its patent rights nor the rights of others.



UQFN8 1.6X1.6, 0.5P
CASE 523AY
ISSUE O

DATE 31 AUG 2016

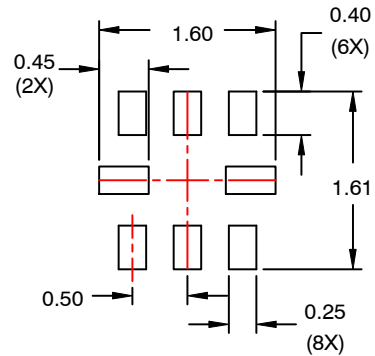
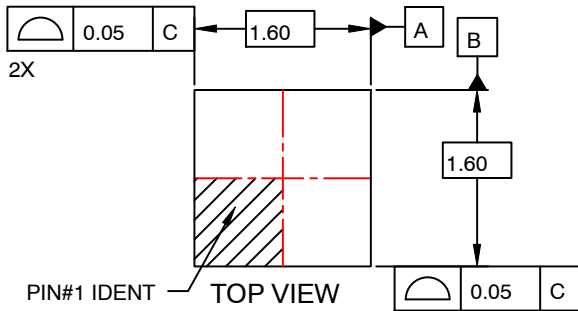

**RECOMMENDED
LAND PATTERN**

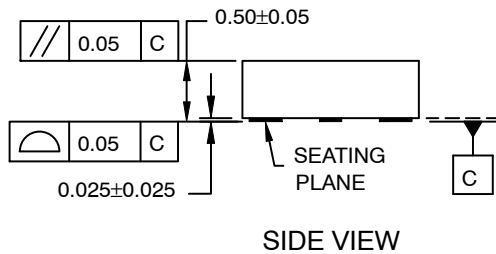

SIDE VIEW

NOTES:

- A. PACKAGE CONFORMS TO JEDEC MO-255 VARIATION UAAD.
- B. DIMENSIONS ARE IN MILLIMETERS.
- C. DIMENSIONS AND TOLERANCES PER ASME Y14.5M, 2009.
- D. LAND PATTERN RECOMMENDATION IS EXISTING INDUSTRY LAND PATTERN.

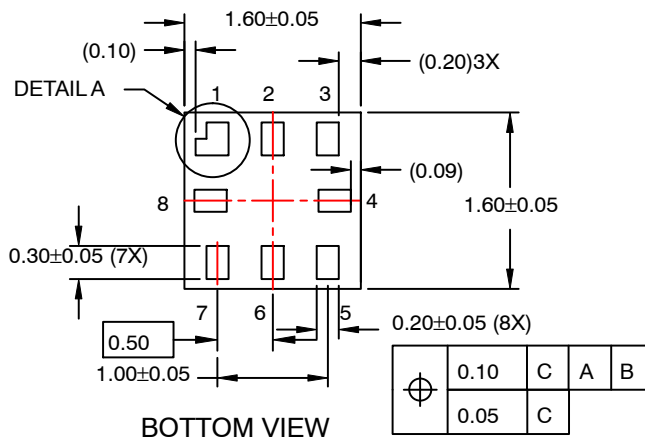

BOTTOM VIEW

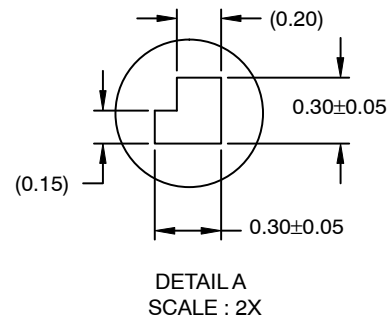

**DETAIL A
SCALE : 2X**

DOCUMENT NUMBER:	98AON13591G	Electronic versions are uncontrolled except when accessed directly from the Document Repository. Printed versions are uncontrolled except when stamped "CONTROLLED COPY" in red.
DESCRIPTION:	UQFN8 1.6X1.6, 0.5P	PAGE 1 OF 1

ON Semiconductor and are trademarks of Semiconductor Components Industries, LLC dba ON Semiconductor or its subsidiaries in the United States and/or other countries. ON Semiconductor reserves the right to make changes without further notice to any products herein. ON Semiconductor makes no warranty, representation or guarantee regarding the suitability of its products for any particular purpose, nor does ON Semiconductor assume any liability arising out of the application or use of any product or circuit, and specifically disclaims any and all liability, including without limitation special, consequential or incidental damages. ON Semiconductor does not convey any license under its patent rights nor the rights of others.

onsemi, **Onsemi**, and other names, marks, and brands are registered and/or common law trademarks of Semiconductor Components Industries, LLC dba "**onsemi**" or its affiliates and/or subsidiaries in the United States and/or other countries. **onsemi** owns the rights to a number of patents, trademarks, copyrights, trade secrets, and other intellectual property. A listing of **onsemi**'s product/patent coverage may be accessed at www.onsemi.com/site/pdf/Patent-Marking.pdf. **onsemi** reserves the right to make changes at any time to any products or information herein, without notice. The information herein is provided "as-is" and **onsemi** makes no warranty, representation or guarantee regarding the accuracy of the information, product features, availability, functionality, or suitability of its products for any particular purpose, nor does **onsemi** assume any liability arising out of the application or use of any product or circuit, and specifically disclaims any and all liability, including without limitation special, consequential or incidental damages. Buyer is responsible for its products and applications using **onsemi** products, including compliance with all laws, regulations and safety requirements or standards, regardless of any support or applications information provided by **onsemi**. "Typical" parameters which may be provided in **onsemi** data sheets and/or specifications can and do vary in different applications and actual performance may vary over time. All operating parameters, including "Typicals" must be validated for each customer application by customer's technical experts. **onsemi** does not convey any license under any of its intellectual property rights nor the rights of others. **onsemi** products are not designed, intended, or authorized for use as a critical component in life support systems or any FDA Class 3 medical devices or medical devices with a same or similar classification in a foreign jurisdiction or any devices intended for implantation in the human body. Should Buyer purchase or use **onsemi** products for any such unintended or unauthorized application, Buyer shall indemnify and hold **onsemi** and its officers, employees, subsidiaries, affiliates, and distributors harmless against all claims, costs, damages, and expenses, and reasonable attorney fees arising out of, directly or indirectly, any claim of personal injury or death associated with such unintended or unauthorized use, even if such claim alleges that **onsemi** was negligent regarding the design or manufacture of the part. **onsemi** is an Equal Opportunity/Affirmative Action Employer. This literature is subject to all applicable copyright laws and is not for resale in any manner.

ADDITIONAL INFORMATION

TECHNICAL PUBLICATIONS:

Technical Library: www.onsemi.com/design/resources/technical-documentation
onsemi Website: www.onsemi.com

ONLINE SUPPORT: www.onsemi.com/support

For additional information, please contact your local Sales Representative at www.onsemi.com/support/sales