

LTC7132

Dual Phase Monolithic Step-Down Supply with PSM

DESCRIPTION

Demonstration circuit 2666A-A/2666A-B features the [LTC®7132](#), a wide input and output voltage range, high efficiency dual output polyphase DC/DC step-down regulator with sub-milliohm DCR sensing and digital power system management. This demo board is available in two versions: DC2666A-A is configured as 2-phase dual output, DC2666A-B is configured as 2-phase single output. Both versions operate over an input voltage range of 6V to 20V. The DC2666A-A factory default output voltage for both outputs are $V_{OUT0} = 1V$, $V_{OUT1} = 1V$ with a 20A load current rating per channel. The DC2666A-B factory default output voltage is $V_{OUT} = 1V$ with a 40A load current rating. Both channels can deliver up to 25A maximum load current for each version.

The output voltages can be programmed from 0.6V up to 1.8V. Programming the output voltages to any value that is greater than 1.8V will require changes to the inductors, external DCR network component and may require the maximum output current to be derated based on thermal derating curves provided in the data sheet of LTC7132. The factory default switching frequency is preset at 425kHz typical. The DC2666A-A/DC2666A-B uses external inductors with extremely low DCR to demonstrate the part's capability of provide excellent performance for sub-milliohm DCR current sense applications.

Both versions of DC2666A comes with PMBus interface and digital power system management functions. An

onboard 12-pin connector is available for users to connect the [DC1613A](#) dongle to the demo board, which provides an easy way to communicate and program the part using [LTpowerPlay®](#) software development tool. LTpowerPlay software and I²C/PMBus/SMBus Dongle DC1613A allows users to monitor real time telemetry of input and output voltages, input and output current, switching frequency, internal IC die temperatures, external power component temperatures and fault logs. Programmable parameters include device address, output voltages, control loop compensation, switching frequency, phase interleaving, DCM or CCM Mode of operation, digital soft-start, sequencing and time based shut down, fault responses to input and output overvoltage, output overcurrent, IC die and power component overtemperatures.

The LTC7132 is available in a thermally enhanced, low profile 140-lead 9mm × 11.25mm × 2.22mm BGA package. It is recommended to read the data sheet and demo manual of LTC7132 prior to use or making any changes to DC2666A-A/DC2666A-B.

DC2666A-A: $6V \leq V_{IN} \leq 20V$; $V_{OUT0}/V_{OUT1} = 0.6V$ to 1.8V at 20A, 25A Peak

DC2666A-B: $6V \leq V_{IN} \leq 20V$; $V_{OUT} = 0.6V$ to 1.8V at 40A, 50A Peak

[Design files for this circuit board are available.](#)

All registered trademarks and trademarks are the property of their respective owners.

DEMO MANUAL

DC2666A-A/DC2666A-B

PERFORMANCE SUMMARY Specifications are at $T_A = 25^\circ\text{C}$

PARAMETER	CONDITIONS	MIN	TYP	MAX	UNITS
DC2666A-A: Dual Phase Dual Output					
Input Voltage Range: V_{IN}		6	12	20	V
Demo Board Default Output Voltages: V_{OUT0} , V_{OUT1}	$f_{SW} = 425\text{kHz}$, $V_{IN} = 6\text{V to } 20\text{V}$, $I_{LOAD} = 0\text{A to } 20\text{A per Channel}$		$1 \pm 0.5\%$		V
Default Switching Frequency: f_{SW}	Factory Default Switching Frequency		425 $\pm 7.5\%$		kHz
Maximum Continuous Output Current I_{OUT} per Channel, I_{OUT0} , I_{OUT1}	$f_{SW} = 425\text{kHz}$, $V_{IN} = 6\text{V to } 20\text{V}$, $V_{OUT0} = 1\text{V}$, $V_{OUT1} = 1\text{V}$		20		A
Efficiency	$V_{IN} = 12\text{V}$, $f_{SW} = 425\text{kHz}$, $V_{OUT0} = 1\text{V}$ at $I_{OUT0} = 20\text{A}$, CCM, $EXTV_{CC} = 5.5\text{V}$		89.20 (Figure 5)		%
Thermal Performance (Peak Temperature)	$V_{IN} = 12\text{V}$, $f_{SW} = 425\text{kHz}$, $V_{OUT0} = 1\text{V}$, $V_{OUT1} = 1\text{V}$, $I_{OUT} = 20\text{A per Channel}$, $EXTV_{CC} = 5.5\text{V}$, $T_A = 25^\circ\text{C}$, No Heatsink, No Forced Airflow		LTC7132: 77 (Figure 7)		$^\circ\text{C}$
DC2666A-B: Dual Phase Single Output					
Input Voltage Range: V_{IN}		6	12	20	V
Demo Board Default Output Voltages: V_{OUT}	$f_{SW} = 425\text{kHz}$, $V_{IN} = 6\text{V to } 20\text{V}$, $I_{LOAD} = 0\text{A to } 40\text{A Max}$		$1 \pm 0.5\%$		V
Default Switching Frequency	Factory Default Switching Frequency		$425 \pm 7.5\%$		kHz
Maximum Continuous Output Current I_{OUT}	$f_{SW} = 425\text{kHz}$, $V_{IN} = 6\text{V to } 20\text{V}$, $V_{OUT} = 1\text{V}$		40		A
Efficiency	$V_{IN} = 12\text{V}$, $f_{SW} = 425\text{kHz}$, $V_{OUT} = 1\text{V}$ at $I_{OUT} = 40\text{A}$, CCM, $EXTV_{CC} = 5.5\text{V}$		88.80 (Figure 6)		%
Thermal Performance (Peak Temperature)	$V_{IN} = 12\text{V}$, $f_{SW} = 425\text{kHz}$, $V_{OUT} = 1\text{V}$, $I_{LOAD} = 40\text{A}$, $EXTV_{CC} = 5.5\text{V}$, $T_A = 25^\circ\text{C}$, No Heatsink, No Forced Airflow		LTC7132: 78.9 (Figure 8)		$^\circ\text{C}$

QUICK START PROCEDURE

Demonstration circuit DC2666A-A/DC2666A-B is easy to set up to evaluate the performance of the LTC7132. Please refer to Figure 4a (DC2666A-A) and Figure 4b (DC2666A-B) for proper measurement equipment setup and follow the test procedures below:

- With power off, connect the input power supply between V_{IN} (J1) and GND (J2).
- Connect the first load between V_{OUT0} (J3) and GND (J4) for channel 0, connect the second load between V_{OUT1} (J5) and GND (J6) for channel 1. Preset all the loads to 0A.
- Connect the DMM between the input test points: V_{IN+} (E1) and V_{IN-} (E2) to monitor the input voltage. Connect DMMs between V_{OUT0+} (E3) and V_{OUT0-} (E4), V_{OUT1+} (E5) and V_{OUT1-} (E6) to monitor corresponding DC output voltages of channel 0 and channel 1.
- Prior power up the DC2666A-A/DC2666A-B, check the default position of the jumpers and switches (Refer to Table 1):

Table 1. Demo Board Default Jumpers and Switches Position

JUMPER/ SWITCH NAME	SW0, SW1	JP1	JP2	JP3
DESCRIPTION	RUN0, RUN1	WP	BIAS	PULSE
POSITION	OFF	OFF	OFF	EXT

- Turn on the power supply at the input, measure and make sure the input supply voltage is 12V. Flip SW0 (RUN0) and SW1 (RUN1) to the ON position. The output voltages should be $1.0\text{V} \pm 0.5\%$ for V_{OUT0} and V_{OUT1} .
- Once the input and output voltages are properly established, adjusting the input voltage between 6V to 20V max and the load current within the operating range

QUICK START PROCEDURE

of 0A to 20A max per channel. Observe the output voltage regulation, output ripple voltage, switching node waveforms, load transient response and other parameters.

NOTE: To measure the input/output voltage ripples properly, do not use the long ground lead on the oscilloscope probe. See Figure 3 for the proper probing technique of input/output voltage ripples. Short, stiff leads need to be soldered to the (+) and (–) terminals of an input or output capacitor. The probe’s ground ring needs to touch the (–) lead and the probe tip needs to touch the (+) lead.

7. DC2666A-A/DC2666A-B provides convenient onboard BNC terminals to accurately measure the output ripple voltage of channel 0 and channel 1. Connect short BNC cables from VOUT0 (J7) and VOUT1 (J8) to the input channels of an oscilloscope. (Scope probe ratio 1:1, AC-coupling) to observe the output ripple voltage.

8. *(Optional) Operation with EXTV_{CC}*

The LTC7132 EXTV_{CC} pin is available for optional use of an external 5.5V bias supply voltage to power the EXTV_{CC} pin, bypassing the internal 5.5V regulator when EXTV_{CC} is higher than 4.7V and V_{IN} is higher than 7V. An onboard LDO (U2) output can be used to supply 5.5V bias voltage for EXTV_{CC} pin. The onboard 5.5V LDO output is enabled by insert R50 with zero ohm and place JP2 (BIAS) to the ON position. Place JP2 (BIAS) to the OFF position to disable the output of this LDO. EXTV_{CC} pin requires a minimum of 4.7μF decoupling ceramic capacitor between this pin and PGND. Do not exceed the maximum rated voltage of EXTV_{CC} pin and make sure V_{IN} is powered up before applying EXTV_{CC}.

9. *(Optional) Onboard Load Step Circuit*

DC2666A-A/DC2666A-B provides an option onboard load transient circuit to quickly check ΔV_{OUT} peak to peak deviation during rising or falling dynamic load transient.

The load step circuit is enabled by place JP2 (BIAS) to the ON position, JP3 (PULSE) to the INT position and

tweak the potentiometer R71 to adjust the amplitude of the pulse load current. Connect a short BNC cable from IOUT STEP (J9) to the input channel of an oscilloscope to monitor the output load current step. The equivalent conversion ratio of voltage to current of IOUT STEP is 10mV/1A. The load step response of VOUT0 is observed by connecting a short BNC cable from VOUT0 (J7) to the input of an oscilloscope channel. Similarly, the load step response of VOUT1 is observed by remove R56 and use this zero-ohm jumper to stuff R58 and connect a short BNC cable from VOUT1 (J8) to the input of an oscilloscope channel. When operating the part as dual phase dual output, R56 and R58 cannot be stuffed at the same time to avoid shorting two outputs together. The onboard load step circuit is disabled by set JP2 (BIAS) to the OFF position. If the fine adjustment of the output load step current rise time and fall time di/dt is required, disable the onboard load step circuit by set JP2 (BIAS) to the OFF position, set JP3 (PULSE) to the EXT position and use an external pulse generator with adjustable dV/dt to apply the pulse voltage at E17 (EXT PULSE) and connect a short BNC cable from IOUT STEP (J9) to the input of an oscilloscope channel to monitor the corresponding load step current. The output current step slew rate and its magnitude is varied by adjusting the rise time, fall time and amplitude of the applied voltage pulse at the gate of the MOSFETs (Q3, Q4). Keep the voltage pulse at the frequency less than 10Hz and maximum duty cycle less than 5% to avoid excessive thermal stress on the MOSFETs.

10. *Connecting a PC to DC2666A-A/DC2666A-B*

Refer to Figure 1a (DC2666A-A) and Figure 1b (DC2666A-B) for proper demo board set up with PC.

Users can use a PC to reconfigure the power management features of the LTC7132 such as: nominal V_{OUT}, margin set points, OV/UV limits, temperature fault limits, sequencing parameters, the fault logs, fault responses, GPIOs and other functionality. The DC1613A dongle can be hot plugged when V_{IN} is present.

QUICK START PROCEDURE

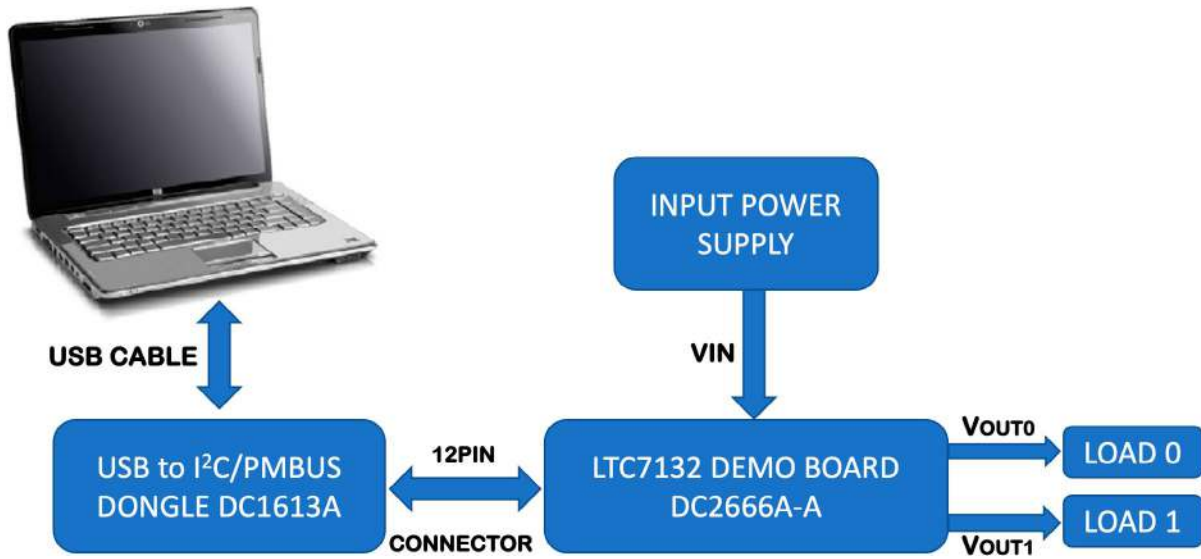

(1a) Demo Setup with PC for DC2666A-A

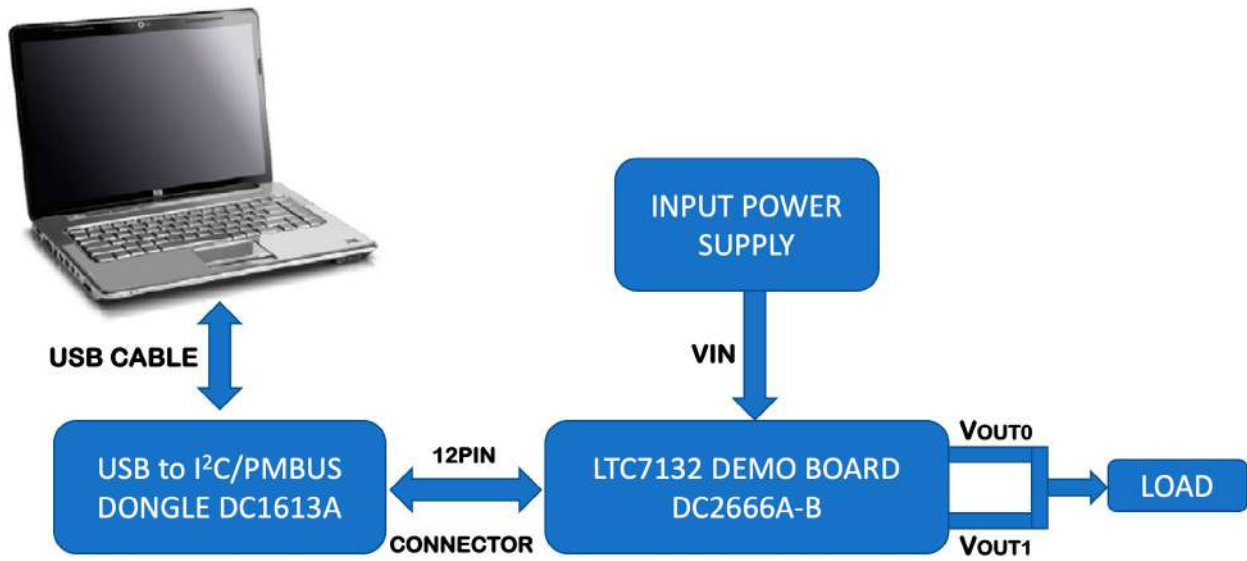

(1b) Demo Setup with PC for DC2666A-B

Figure 1.

QUICK START PROCEDURE

LTpowerPlay Quick Start Guide

LTpowerPlay is a powerful Windows-based development environment that supports ADI power system management ICs. The software supports a variety of different tasks. You can use LTpowerPlay to evaluate ADI PSM ICs by connecting to a demo board system. LTpowerPlay can also be used in an offline mode (with no hardware present) to build a multichip configuration file that can be saved and reloaded anytime. LTpowerPlay provides unprecedented diagnostic tool and debug features. It becomes a valuable diagnostic tool during board bring-up to program or tweak the power management scheme in a system, or to diagnose power issues when bringing up rails. LTpowerPlay utilizes the DC1613A USB-to-SMBus controller to communicate with one of many potential targets, including all the parts in PSM product category demo system. The software also provides an automatic update feature to keep the software current with the latest set of device drivers and documentation. The LTpowerPlay software can be downloaded from: [LTpowerPlay](#). USB to PMBus Controller Dongle DC1613A for use with LTpowerPlay is available at: [DC1613A](#)

To access technical support documents for LTC Digital Management Products, visit Help or view online help on the LTpowerPlay menu.

The following procedure describes how to use LTpowerPlay to monitor and change the settings of LTC7132:

1. Download and install the LTpowerPlay GUI: [LTpowerPlay](#)

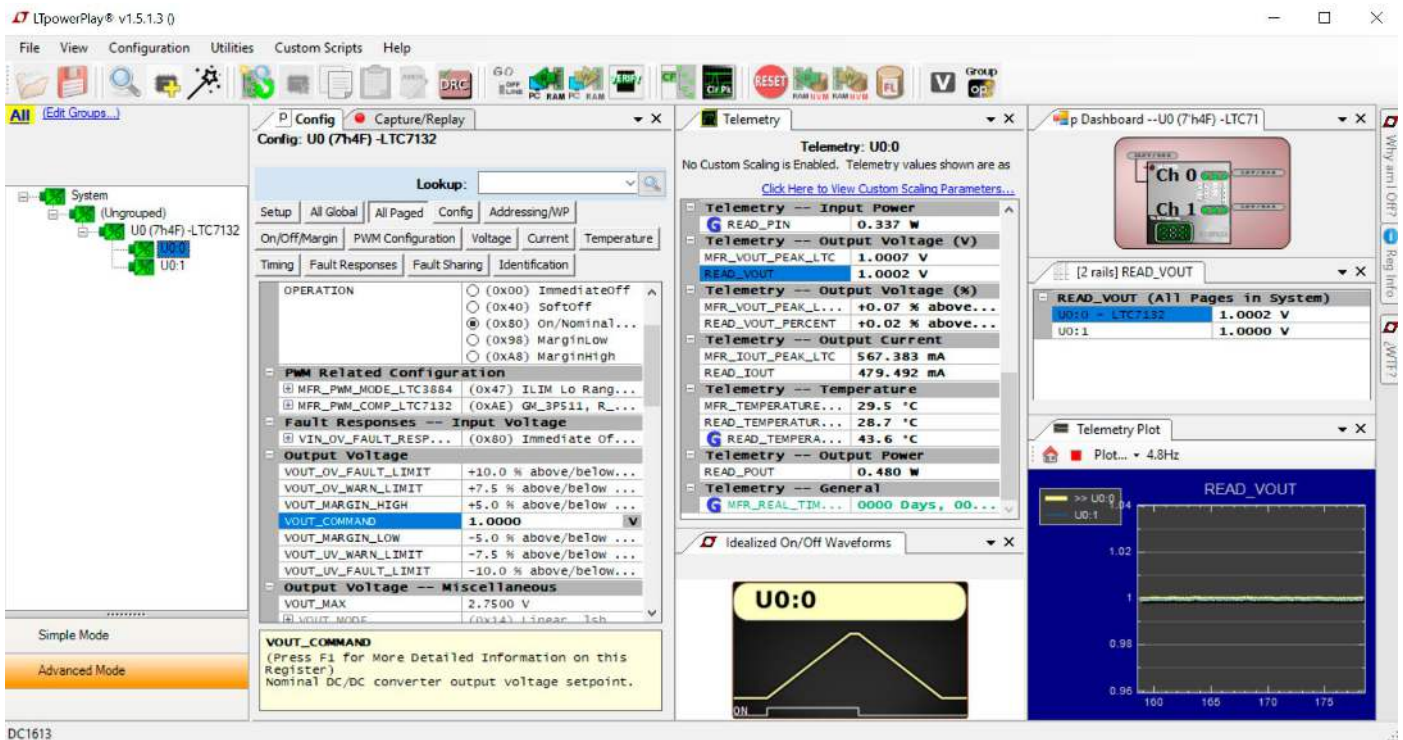

Figure 2. LTpowerPlay Main Interface

DEMO MANUAL

DC2666A-A/DC2666A-B

QUICK START PROCEDURE

1. Launch the LTpowerPlay GUI
 - a. The GUI should automatically identify the DC2666A-A/DC2666A-B.

The system tree on the left-hand side should look like this:

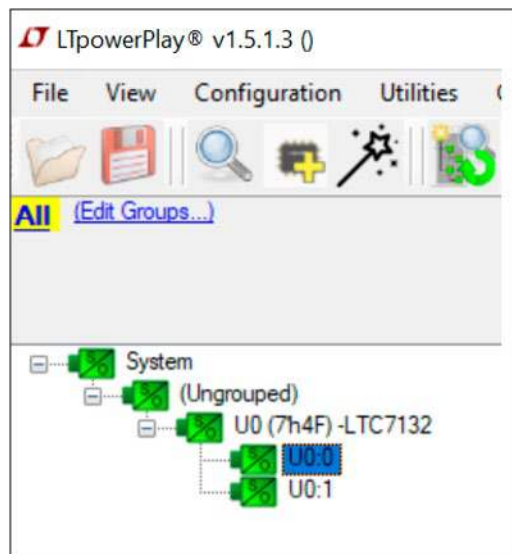

- b. A green message box shows for a few seconds in the lower left-hand corner, confirming that the LTC7132 is communicating:

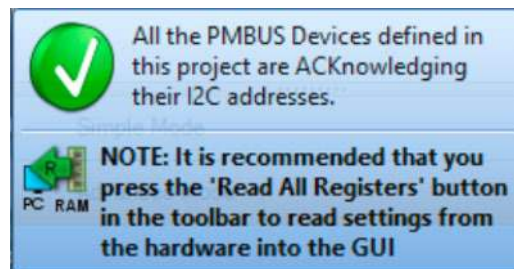

- c. In the Toolbar, click the R (RAM to PC) icon to read the RAM from the LTC7132. The configuration is read from the RAM of the LTC7132 and loaded into the GUI.



QUICK START PROCEDURE

d. Example of program the output voltage to a different value:

In the Config Tab, click on the Voltage Tab in the main menu bar, type in 1.2V in the VOUT_COMMAND box as showed below:

The screenshot shows the 'Config' window for 'U0 (7h4F) -LTC7132'. The 'Voltage' tab is active. The 'VOUT_COMMAND' register is selected and shows a value of '1.2000 V'. Below the register list, a tooltip for 'VOUT_COMMAND' is displayed, stating: '(Press F1 for More Detailed Information on this Register) Nominal DC/DC converter output voltage setpoint.'

Register Name	Value
VOUT_OV_FAULT_LIMIT	+10.0 % above/below...
VOUT_OV_WARN_LIMIT	+7.5 % above/below ...
VOUT_MARGIN_HIGH	+5.0 % above/below ...
VOUT_COMMAND	1.2000 V
VOUT_MARGIN_LOW	-5.0 % above/below ...
VOUT_UV_WARN_LIMIT	-7.5 % above/below ...
VOUT_UV_FAULT_LIMIT	-10.0 % above/below...
Output Voltage -- Miscellaneous	
VOUT_MAX	2.7500 V
VOUT_MODE	(0x14) Linear, 1sb...
MFR_VOUT_MAX	2.7500 V
VOUT_TRANSITION_RATE	0.250 V/ms
Fault Responses -- Output Voltage	
TON_MAX_FAULT_RES...	(0xB8) Immediate Of...
VOUT_UV_FAULT_RES...	(0xB8) Immediate Of...
VOUT_OV_FAULT_RES...	(0xB8) Immediate Of...
Output Current Calibration	
IOUT_CAL_GAIN	0.305 mOhms
MFR_IOUT_CAL_GAIN_TC	3900 ppm/°C

Then click the W (PC to RAM) icon to write these register values to the LTC7132.



QUICK START PROCEDURE

The output voltage will change to 1.2V.

If the write is successful, the following message should be seen:

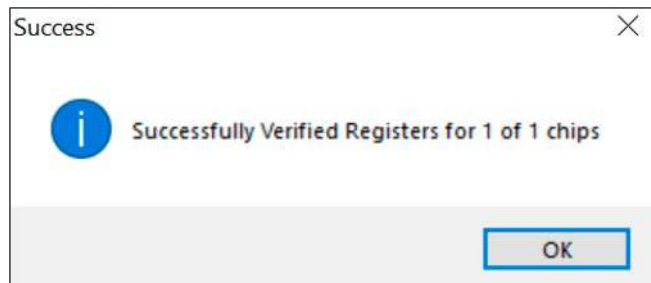

e. All user configurations or changes can be saved in to the NVM. In the toolbar, click RAM to NVM icon:



f. Save the demo board configuration to a (*.proj) file. Click the Save icon and save the file with a preferred file name.

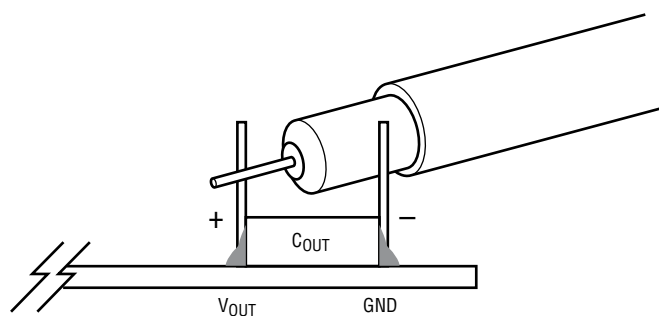
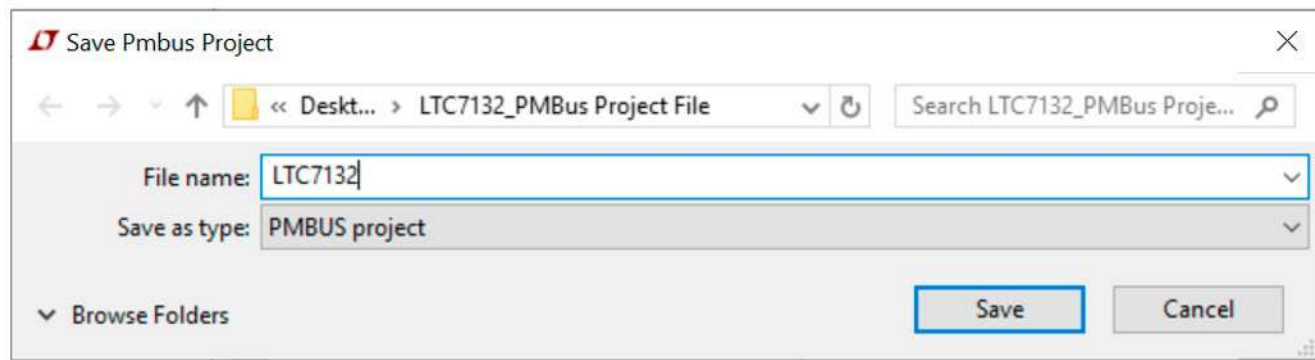
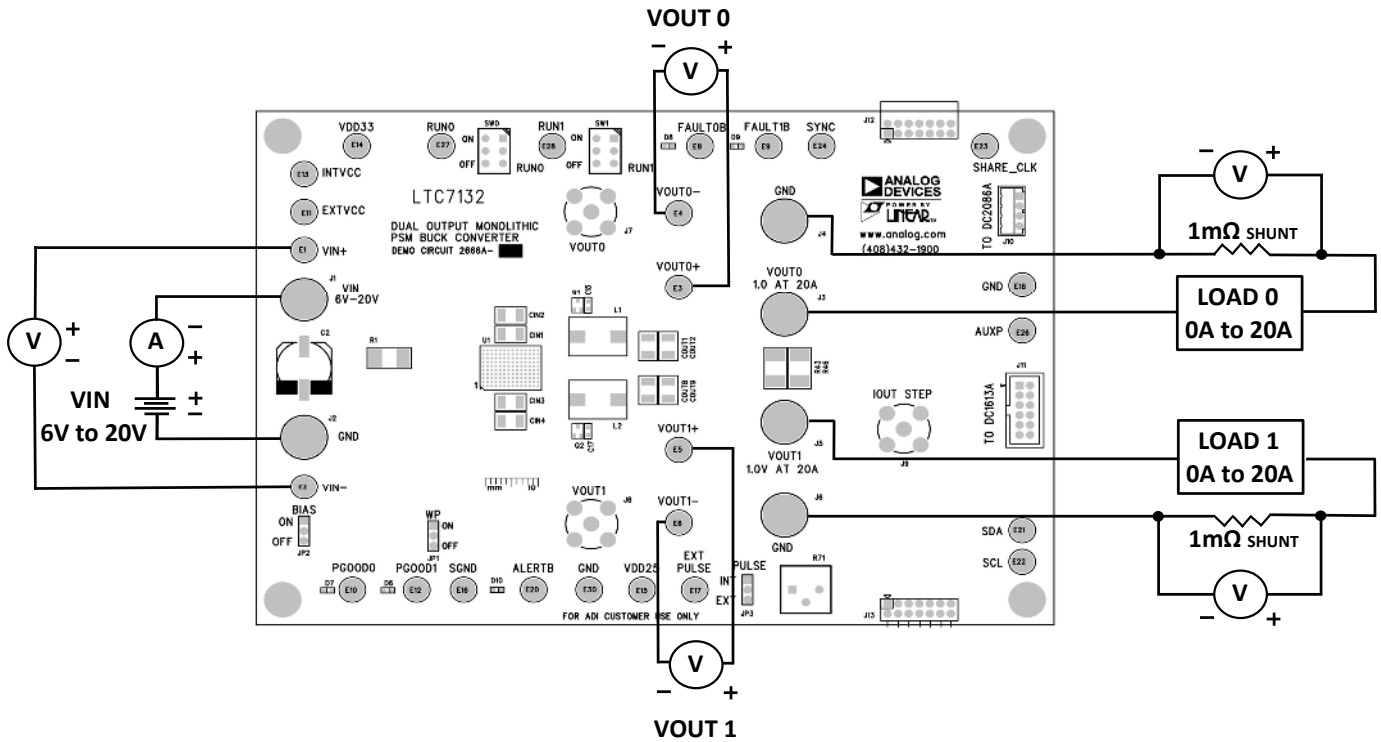
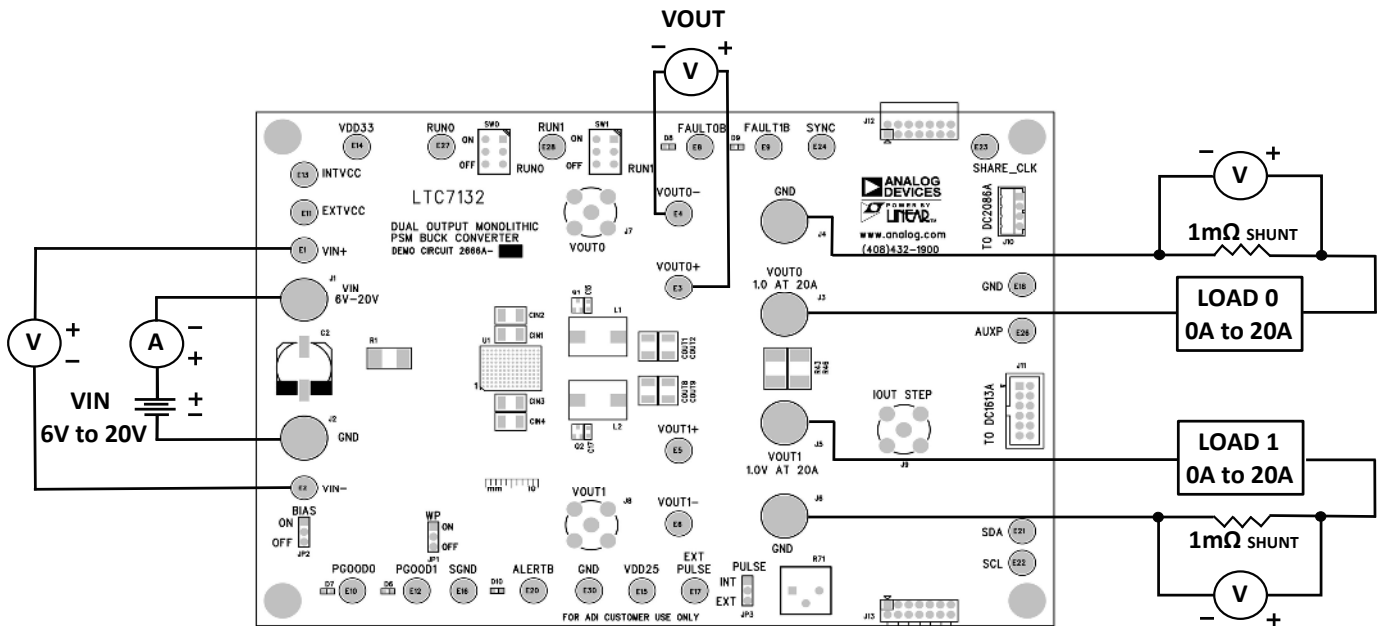

Figure 3. Scope Probe Placement for Measuring Input or Output Ripple Voltage

QUICK START PROCEDURE



(4a) Proper Measurement Equipment Setup for DC2666A-A



(4b) Proper Measurement Equipment Setup for DC2666A-B

Figure 4.

DEMO MANUAL

DC2666A-A/DC2666A-B

QUICK START PROCEDURE

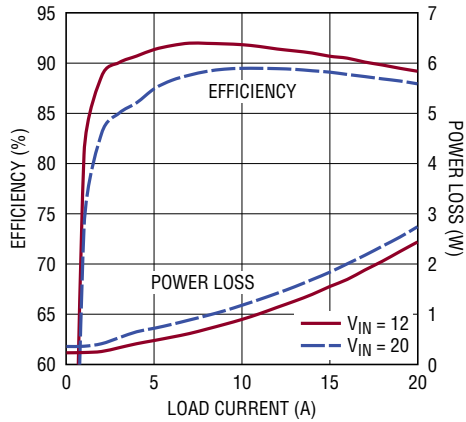

CIRCUIT CONFIGURATION:
 DUAL PHASE DUAL OUTPUT
 $f_{SW} = 425\text{kHz}$
 $V_{OUT} = 1\text{V}$
 $I_{LOAD} = 0\text{A TO } 20\text{A}$
 $EXTV_{CC} = 5.5\text{V}$ (EXTERNAL 5.5V BIAS VOLTAGE SUPPLY USED)
 ONE OUTPUT RAIL IS ENABLED AT A TIME

dc2666a F05

Figure 5. DC2666A-A: Efficiency

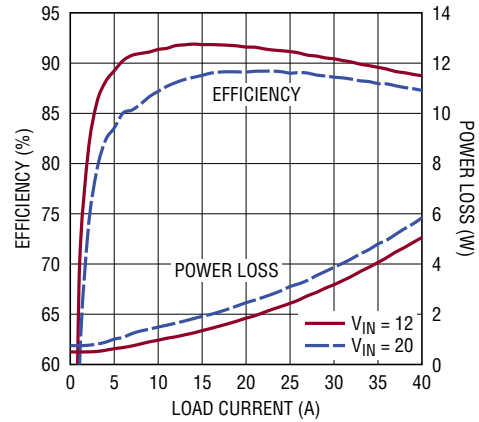

CIRCUIT CONFIGURATION:
 DUAL PHASE SINGLE OUTPUT
 $f_{SW} = 425\text{kHz}$
 $V_{OUT} = 1\text{V}$
 $I_{LOAD} = 0\text{A TO } 40\text{A}$
 $EXTV_{CC} = 5.5\text{V}$ (EXTERNAL 5.5V BIAS VOLTAGE SUPPLY USED)

dc2666a F06

Figure 6. DC2666A-B: Efficiency

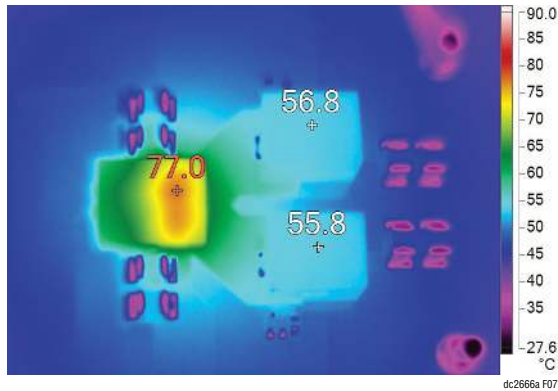

dc2666a F07

CIRCUIT CONFIGURATION: DUAL PHASE DUAL OUTPUT
 $f_{SW} = 425\text{kHz TYPICAL}$
 $V_{IN} = 12\text{V}$
 $V_{OUT0} = 1\text{V}, V_{OUT1} = 1\text{V}$
 $I_{LOAD0} = 20\text{A}, I_{LOAD1} = 20\text{A}$
 $EXTV_{CC} = 5.5\text{V}$ (EXTERNAL 5.5V POWER SUPPLY USED)
 $T_A = 25^\circ\text{C}$, NO HEATSINK, NO FORCED AIRFLOW

Figure 7. DC2666A-A: Thermal Performance

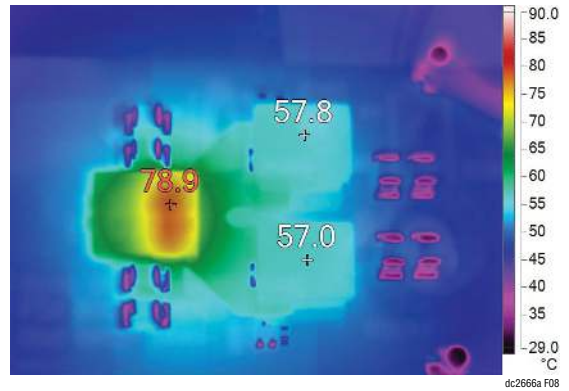

dc2666a F08

CIRCUIT CONFIGURATION: DUAL PHASE SINGLE OUTPUT
 $f_{SW} = 425\text{kHz TYPICAL}$
 $V_{IN} = 12\text{V}$
 $V_{OUT} = 1\text{V}$
 $I_{LOAD_TOTAL} = 40\text{A}$
 $EXTV_{CC} = 5.5\text{V}$ (EXTERNAL 5.5V POWER SUPPLY USED)
 $T_A = 25^\circ\text{C}$, NO HEATSINK, NO FORCED AIRFLOW

Figure 8. DC2666A-B: Thermal Performance

QUICK START PROCEDURE

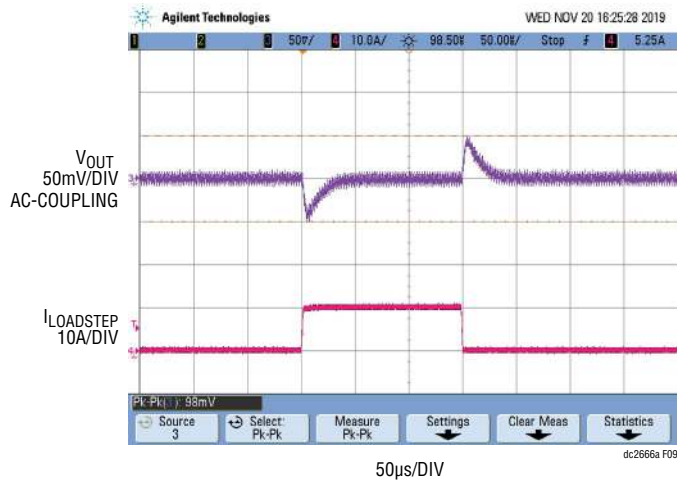

CIRCUIT CONFIGURATION: DUAL PHASE DUAL OUTPUT
 $f_{SW} = 425\text{kHz}$
 $V_{IN} = 12\text{V}$
 $V_{OUT} = 1\text{V}$
 $I_{LOADSTEP} = 0\text{A TO } 10\text{A AT } 10\text{A}/\mu\text{s}$
 $V_{OUT(P-P)} = 98\text{mV}$

Figure 9. DC2666A-A: Load Transient Response

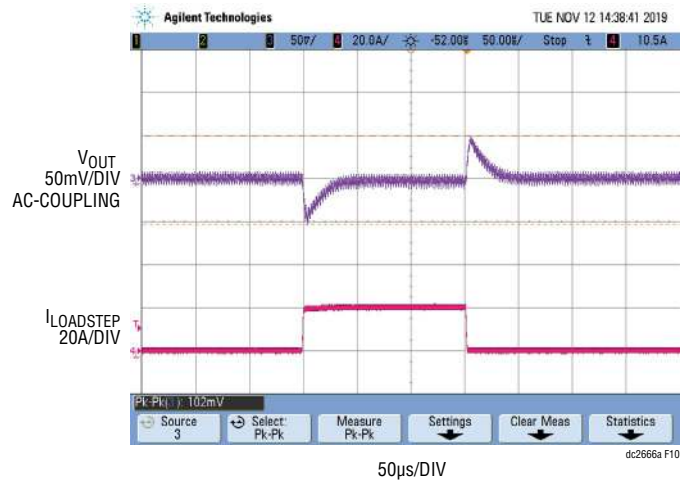

CIRCUIT CONFIGURATION: DUAL PHASE SINGLE OUTPUT
 $f_{SW} = 425\text{kHz}$
 $V_{IN} = 12\text{V}$
 $V_{OUT} = 1\text{V}$
 $I_{LOADSTEP} = 0\text{A TO } 20\text{A AT } 20\text{A}/\mu\text{s}$
 $V_{OUT(P-P)} = 102\text{mV}$

Figure 10. DC2666A-B: Load Transient Response

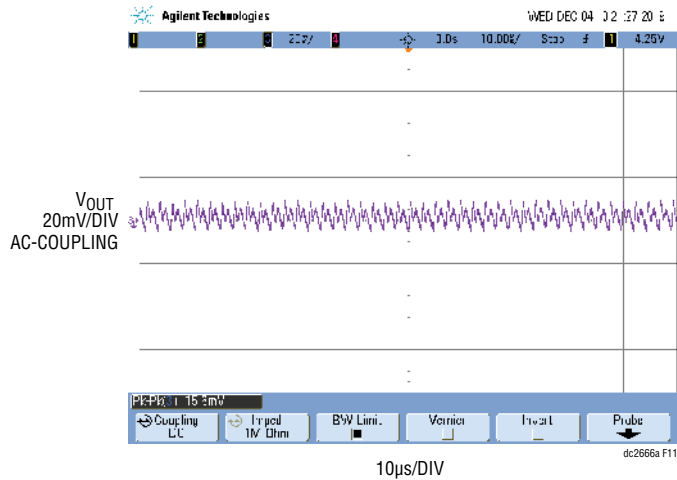

CIRCUIT CONFIGURATION: DUAL PHASE DUAL OUTPUT
 $f_{SW} = 425\text{kHz}$
 $V_{OUT} = 1\text{V}$
 $I_{LOAD} = 20\text{A}$
 $V_{OUT(P-P)} = 15.6\text{mV}$

Figure 11. DC2666A-A: Output Ripple Voltage

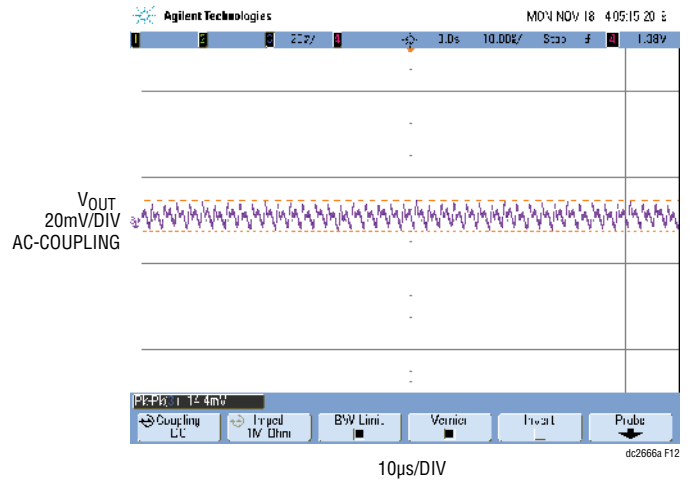

CIRCUIT CONFIGURATION: DUAL PHASE SINGLE OUTPUT
 $f_{SW} = 425\text{kHz}$
 $V_{OUT} = 1\text{V}$
 $I_{LOAD} = 40\text{A}$
 $V_{OUT(P-P)} = 14.4\text{mV}$

Figure 12. DC2666A-B: Output Ripple Voltage

DEMO MANUAL

DC2666A-A/DC2666A-B

PARTS LIST

ITEM	QTY	REFERENCE	PART DESCRIPTION	MANUFACTURER/PART NUMBER
DC2666A-A Required Circuit Components				
1	4	CIN1, CIN2, CIN3, CIN4	CAP, 1210 22 μ F 20% 25V X5R	MURATA GRM32ER61E226ME15L
2	9	COUT1, COUT2, COUT5, COUT6, COUT8, COUT9, COUT12, COUT13, C22	CAP, 1210 100 μ F 20% 6.3V X5R	MURATA GRM32ER60J107ME20L
3	4	COUT3, COUT4, COUT10, COUT11	CAP, 7343 330 μ F 20% 6.3V POSCAP	PANASONIC 6TPF330M9L
4	5	COUT15, COUT16, C5, C25, C26	CAP, 0603 1 μ F 20% 25V X5R	MURATA GRM188R61E105MA12D
5	2	C1, C4	CAP, 0603 2.2 μ F 10% 10V X7R	MURATA GRM188R71A225KE15D
6	1	C2	CAP, 180 μ F 20% 25V OSCON	PANASONIC 25SVPF180M
7	2	C6, C8	CAP, 0603 4.7 μ F 20% 25V X5R	TDK C1608X5R1E475M080AC
8	2	C9, C16	CAP, 0603 0.1 μ F 5% 50V X7R	KEMET C0603X104J5RECAUTO
9	2	C10, C18	CAP, 25V 0.22 μ F 0603 X7R 5%	KEMET C0603C224J3RACTU
10	3	C11, C13, C24	CAP, 0603 150pF 5% 50V NPO	AVX 06035A151JAT2A
11	2	C12, C14	CAP, 0603 2200pF 5% 50V C0G	MURATA GRM1885C1H222JA01D
12	4	C15, C17, C28, C29	CAP, 0603 10nF 10% 25V X7R	AVX 06033C103KAT2A
13	2	C19, C20	CAP, 1210 10 μ F 10% 25V X7R	MURATA GRM32DR71E106KA12L
14	2	C23, C27	CAP, 0603 100nF 20% 16V X7R	AVX 0603YC104MAT2A
15	2	D1, D2	DIODE, SCHOTTKY 30V, 100mA	CENTRAL SEMI CMDSH-3-TR
16	1	D3	DIODE, 0.5A ULTRA LOW VF SCHOTTKY	NEXPERIA PMEG2005AEL
17	4	D6, D7, D8, D9	LED, 0603 GREEN	WURTH ELEKTRONIK 150060GS75000
18	1	D10	LED, 0603 RED	WURTH ELEKTRONIK 150060SS75000
19	2	L1, L2	IND, 0.3 μ H DCR = 0.29m Ω	EATON, FP1007R3-R30-R
20	2	Q1, Q2	XSTR, PNP GENERAL PURPOSE	DIODES INC. MMST3906-7-F
21	2	Q3, Q4	XSTR, N-CH 40V 14A TO-252	VISHAY SUD50N04-8M8P-4GE3
22	1	Q5	MOSFET P-CH 20V 5.2A SOT-23	VISHAY SI2365EDS-T1-GE3
23	4	Q7, Q8, Q9, Q10	XSTR, N-CH 60V 0.21A SOT-23	DIODES INC 2N7002-7-F
24	1	R1	RES., 0.005 Ω , 1%, 2W, 2512	PANASONIC ERJMP4PF5MOU
25	1	R2	RES, 0603 1 Ω 1% 1/10W	VISHAY CRCW06031R00FKEA
26	10	R3, R4, R15, R17, R21, R23, R60, R75, R77, R79	RES, 0603 0 Ω JUMPER	YAGEO RC0603FR-070RL
27	11	R5, R6, R7, R9, R37, R38, R39, R40, R53, R55, R66	RES, 0603 10k 5% 1/10W	VISHAY CRCW060310K0JNEA
28	6	R8, R10, R11, R12, R84, R85	RES, 0603 4.99k 1% 1/10W	VISHAY CRCW06034K99FKEA
29	6	R13, R16, R19, R22, R82, R83	RES, 0603 10 Ω 1% 1/10W	VISHAY CRCW060310R0FKEA
30	2	R14, R20	RES, 0603 931 Ω 1% 1/10W	NIC NRC06F9310TRF
31	1	R54	RES, 0603 34.8k 1% 1/10W	VISHAY CRCW060334K8FKEA
32	1	R56	RES, 2010 0 Ω JUMPER	VISHAY CRCW20100000Z0EF
33	1	R57	RES, 0603 2 Ω 5% 1/10W	VISHAY CRCW06032R00JNEA
34	1	R59	RES, 0603 154k 1% 1/10W	VISHAY CRCW0603154KFKEA
35	1	R61	RES, 0603 1M 5% 1/10W	VISHAY CRCW06031M00JNEA
36	2	R62, R64	RES, 0603 20k 5% 1/10W	VISHAY CRCW060320K0JNEA
37	1	R63	RES, 0603 3.3 Ω 1% 1/10W	VISHAY CRCW06033R30FKEA
38	1	R65	RES, 0603 681k 1% 1/10W	YAGEO RC0603FR-07681KL

PARTS LIST

ITEM	QTY	REFERENCE	PART DESCRIPTION	MANUFACTURER/PART NUMBER
39	1	R67	RES, 0603 249Ω 1% 1/10W	VISHAY CRCW0603249RFKEA
40	1	R68	RES, 0603 82.5Ω 1% 1/10W	VISHAY CRCW060382R5FKEA
41	1	R69	RES, 2512 0.01Ω 1% 1W	VISHAY WSL2512R0100FEA
42	1	R71	RES, VARIABLE 5k	BOURNS 3386P-1-502-LF
43	1	R72	RES, 0603 649Ω 1% 1/10W	VISHAY CRCW0603649RFKEA
45	4	R91, R92, R93, R94	RES, 0603 200Ω 5% 1/10W	VISHAY CRCW0603200RJNEA
46	1	R97	RES, 0603 127Ω 1% 1/10W	VISHAY CRCW0603127RFKEA
47	1	U1	IC, LTC7132 BGA	ANALOG DEVICES INC., LTC7132IY#PBF-ES
48	1	U2	IC, LT1761ES5-SD REGULATOR SOT-23-S5	ANALOG DEVICES INC., LT1761ES5-SD#PBF
49	1	U3	IC, LTC6992IS6-1	ANALOG DEVICES INC., LTC6992IS6-1#PBF
50	1	U4	IC, LT1803IS5 SINGLE OP AMP	ANALOG DEVICES INC., LT1803IS5#PBF
51	1	U5	IC, 24LC024-I/ST	MICROCHIP 24LC024-I/ST

Additional Demo Board Circuit Components

1	0	COU7, COU14	CAP, 7343, OPTION	OPTION
2	0	C3	CAP, OPTION	OPTION
3	0	C7	CAP, 0603, OPTION	OPTION
4	0	C21	CAP, 1210, OPTION	OPTION
5	0	D4, D5	DIODE, SOD-323, OPTION	OPTION
6	0	Q6	XSTR, OPTION	DIODES INC. DMP3130L-7
7	0	R43, R46, R51, R52, R70	RES, 2512, OPTION	OPTION
8	0	R18, R24, R25, R26, R27, R28, R29, R30, R31, R32, R33, R34, R35, R36, R41, R42, R44, R45, R47, R48, R49, R50, R73, R74, R76, R78, R80, R81, R86, R87, R89, R90, R95, R96	RES, 0603, OPTION	OPTION
9	0	R58	RES, 2010, OPTION	OPTION
10	0	R88	RES, 1206, OPTION	OPTION

Hardware: For Demo Board Only

1	26	E1-E6, E8-E18, E20-E24, E26-E28, E30	TEST POINT, TURRET, 0.094"	MILL-MAX, 2501-2-00-80-00-00-07-0
2	3	JP1, JP2, JP3	HEADER, SINGLE ROW 3-PIN	WURTH ELEKTRONIK 62000311121
3	6	J1, J2, J3, J4, J5, J6	BANANA JACK CONNECTOR	KEYSTONE, 575-4
4	3	J7, J8, J9	CONN., RF, BNC, RCPT, THT, STR, 5-PIN	AMPHENOL CONNEX, 112404
5	1	J10	HEADER, 4-PIN 2mm STR DL	HIROSE, DF3A-4P-2DSA
6	1	J11	HEADER, 12-PIN 2mm STR DL	FCI 98414-G06-12ULF
7	1	J12	CONN., HDR, FEMALE, 2x7, 2mm, R/A THT	SULLINS CONNECTOR SOLUTIONS, NPPN072FJFN-RC
8	1	J13	CONN., HDR, MALE, 2x7, 2mm, R/A THT	MOLEX, 87760-1416
9	2	SW0, SW1	SWITCH, SUBMINIATURE SLIDE	C&K JS202011CQN
10	3	XJP1, XJP2, XJP3	SHUNT	WURTH ELEKTRONIK 60800213421
11	4	STANDOFF	STANDOFF, NYLON, SNAP-ON, 0.50"	WURTH ELEKTRONIK, 702935000

DEMO MANUAL

DC2666A-A/DC2666A-B

PARTS LIST

ITEM	QTY	REFERENCE	PART DESCRIPTION	MANUFACTURER/PART NUMBER
DC2666A-B Required Circuit Components				
1	4	CIN1, CIN2, CIN3, CIN4	CAP, 1210 22µF 20% 25V X5R	MURATA GRM32ER61E226ME15L
2	9	COU1, COU2, COU5, COU6, COU8, COU9, COU12, COU13, C22	CAP, 1210 100µF 20% 6.3V X5R	MURATA GRM32ER60J107ME20L
3	4	COU3, COU4, COU10, COU11	CAP, 7343 330µF 20% 6.3V POSCAP	PANASONIC 6TPF330M9L
4	5	COU15, COU16, C5, C25, C26	CAP, 0603 1µF 20% 25V X5R	MURATA GRM188R61E105MA12D
5	2	C1, C4	CAP, 0603 2.2µF 10% 10V X7R	MURATA GRM188R71A225KE15D
6	1	C2	CAP, 180µF 20% 25V OSCON	PANASONIC 25SVPF180M
7	2	C6, C8	CAP, 0603 4.7µF 20% 25V X5R	TDK C1608X5R1E475M080AC
8	2	C9, C16	CAP, 0603 0.1µF 5% 50V X7R	KEMET C0603X104J5RECAUTO
9	2	C10, C18	CAP, 25V 0.22µF 0603 X7R 5%	KEMET C0603C224J3RACTU
10	1	C11	CAP, 0603 220pF 5% 50V NPO	AVX 06035A221JAT2A
11	1	C12	CAP, 50V 4700pF X7R 0603 5% AEC-Q200	AVX 06035C472J4T2A
12	1	C13	CAP, 0603 10pF 1% 50V NPO	AVX 06035A100FAT2A
13	4	C15, C17, C28, C29	CAP, 0603 10nF 10% 25V X7R	AVX 06033C103KAT2A
14	2	C19, C20	CAP, 1210 10µF 10% 25V X7R	MURATA GRM32DR71E106KA12L
15	1	C24	CAP, 0603 150pF 5% 50V NPO	AVX 06035A151JAT2A
16	2	C23, C27	CAP, 0603 100nF 20% 16V X7R	AVX 0603YC104MAT2A
17	2	D1, D2	DIODE, SCHOTTKY 30V, 100mA	CENTRAL SEMI CMDSH-3-TR
18	1	D3	DIODE, 0.5A ULTRA LOW VF SCHOTTKY	NEXPERIA PMEG2005AEL
19	4	D6, D7, D8, D9	LED, 0603 GREEN	WURTH ELEKTRONIK 150060GS75000
20	1	D10	LED, 0603 RED	WURTH ELEKTRONIK 150060SS75000
21	2	L1, L2	IND, 0.3µH DCR = 0.29mΩ	EATON, FP1007R3-R30-R
22	2	Q1, Q2	XSTR, PNP GENERAL PURPOSE	DIODES INC. MMST3906-7-F
23	2	Q3, Q4	XSTR, N-CH 40V 14A TO-252	VISHAY SUD50N04-8M8P-4GE3
24	1	Q5	MOSFET P-CH 20V 5.2A SOT-23	VISHAY SI2365EDS-T1-GE3
25	4	Q7, Q8, Q9, Q10	XSTR, N-CH 60V 0.21A SOT-23	DIODES INC 2N7002-7-F
26	1	R1	RES., 0.005Ω, 1%, 2W, 2512	PANASONIC ERJ-MP4PF5M0U
27	1	R2	RES, 0603 1Ω 1% 1/10W	VISHAY CRCW06031R00FKEA
28	17	R3, R4, R15, R17, R21, R23, R60, R75, R77, R79, R41, R42, R44, R45, R47, R48, R49	RES, 0603 0Ω JUMPER	YAGEO RC0603FR-070RL
29	11	R5, R6, R7, R9, R37, R38, R39, R40, R53, R55, R66	RES, 0603 10k 5% 1/10W	VISHAY CRCW060310K0JNEA
30	6	R8, R10, R11, R12, R84, R85	RES, 0603 4.99k 1% 1/10W	VISHAY CRCW06034K99FKEA
31	4	R13, R16, R82, R83	RES, 0603 10Ω 1% 1/10W	VISHAY CRCW060310R0FKEA
32	2	R14, R20	RES, 0603 931Ω 1% 1/10W	NIC NRC06F9310TRF
33	2	R43, R46	RES, 2512 0.001Ω 1% 1W	PANASONIC ERJ-M1WTF1M0U
34	1	R54	RES, 0603 34.8k 1% 1/10W	VISHAY CRCW060334K8FKEA
35	1	R56	RES, 2010 0Ω JUMPER	VISHAY CRCW20100000Z0EF
36	1	R57	RES, 0603 2Ω 5% 1/10W	VISHAY CRCW06032R00JNEA
37	1	R59	RES, 0603 154k 1% 1/10W	VISHAY CRCW0603154KFKEA
38	1	R61	RES, 0603 1M 5% 1/10W	VISHAY CRCW06031M00JNEA

DEMO MANUAL

DC2666A-A/DC2666A-B

PARTS LIST

ITEM	QTY	REFERENCE	PART DESCRIPTION	MANUFACTURER/PART NUMBER
39	2	R62, R64	RES, 0603 20k 5% 1/10W	VISHAY CRCW060320K0JNEA
40	1	R63	RES, 0603 3.3Ω 1% 1/10W	VISHAY CRCW06033R30FKEA
41	1	R65	RES, 0603 681k 1% 1/10W	YAGEO RC0603FR-07681KL
42	1	R67	RES, 0603 249Ω 1% 1/10W	VISHAY CRCW0603249RFKEA
43	1	R68	RES, 0603 82.5Ω 1% 1/10W	VISHAY CRCW060382R5FKEA
44	1	R69	RES, 2512 0.01Ω 1% 1W	VISHAY WSL2512R0100FEA
45	1	R71	RES, VARIABLE 5k	BOURNS 3386P-1-502-LF
46	1	R72	RES, 0603 649Ω 1% 1/10W	VISHAY CRCW0603649RFKEA
47	4	R91, R92, R93, R94	RES, 0603 200Ω 5% 1/10W	VISHAY CRCW0603200RJNEA
48	1	R97	RES, 0603 127Ω 1% 1/10W	VISHAY CRCW0603127RFKEA
49	1	U1	IC, LTC7132 BGA	ANALOG DEVICES INC., LTC7132IY#PBF-ES
50	1	U2	IC, LT1761ES5-SD REGULATOR SOT-23-S5	ANALOG DEVICES INC., LT1761ES5-SD#PBF
51	1	U3	IC, LTC6992IS6-1	ANALOG DEVICES INC., LTC6992IS6-1#PBF
52	1	U4	IC, LT1803IS5 SINGLE OP AMP	ANALOG DEVICES INC., LT1803IS5#PBF
53	1	U5	IC, 24LC024-I/ST	MICROCHIP 24LC024-I/ST

Additional Demo Board Circuit Components

1	0	COU7, COU14	CAP, 7343, OPTION	OPTION
2	0	C3	CAP, OPTION	OPTION
3	0	C7	CAP, 0603, OPTION	OPTION
4	0	C14	CAP, 0603, OPTION	OPTION
5	0	C21	CAP, 1210, OPTION	OPTION
6	0	D4, D5	DIODE, SOD-323, OPTION	OPTION
7	0	Q6	XSTR, OPTION	DIODES INC. DMP3130L-7
8	0	R51, R52, R70	RES, 2512, OPTION	OPTION
9	0	R18, R19, R22, R24-R36, R50, R73, R74, R76, R78, R80, R81, R86, R87, R90, R95, R96	RES., OPTION, 0603	OPTION
10	0	R58	RES, 2010, OPTION	OPTION
11	0	R88	RES, 1206, OPTION	OPTION

Hardware: For Demo Board Only

1	26	E1-E6, E8-E18, E20-E24, E26-E28, E30	TEST POINT, TURRET, 0.094"	MILL-MAX, 2501-2-00-80-00-00-07-0
2	3	JP1, JP2, JP3	HEADER, SINGLE ROW 3-PIN	WURTH ELEKTRONIK 62000311121
3	6	J1, J2, J3, J4, J5, J6	BANANA JACK CONNECTOR	KEYSTONE, 575-4
4	3	J7, J8, J9	CONN., RF, BNC, RCPT, THT, STR, 5-PIN	AMPHENOL CONNEX, 112404
5	1	J10	HEADER, 4-PIN 2mm STR DL	HIROSE, DF3A-4P-2DSA
6	1	J11	HEADER, 12-PIN 2mm STR DL	FCI 98414-G06-12ULF
7	1	J12	CONN., HDR, FEMALE, 2x7, 2mm, R/A THT	SULLINS CONNECTOR SOLUTIONS, NPPN072FJFN-RC
8	1	J13	CONN., HDR, MALE, 2x7, 2mm, R/A THT	MOLEX, 87760-1416
9	2	SW0, SW1	SWITCH, SUBMINIATURE SLIDE	C&K JS202011CQN
10	3	XJP1, XJP2, XJP3	SHUNT	WURTH ELEKTRONIK 60800213421
11	4	STANDOFF	STANDOFF, NYLON, SNAP-ON, 0.50"	WURTH ELEKTRONIK, 702935000

SCHEMATIC DIAGRAM

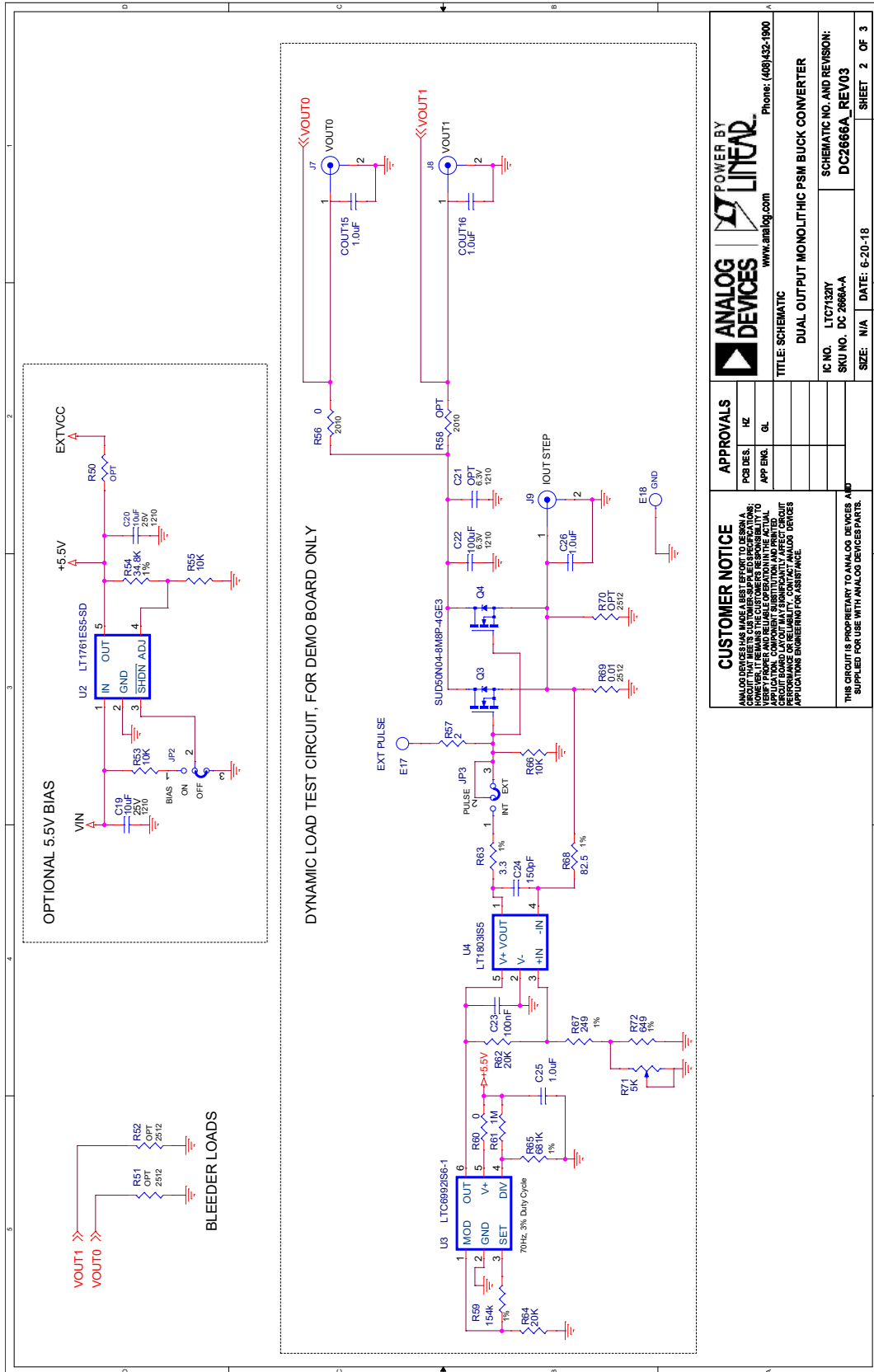

Figure 13b. DC2666A-A Demo Circuit Schematic, Sheet 2

DEMO MANUAL DC2666A-A/DC2666A-B

SCHEMATIC DIAGRAM

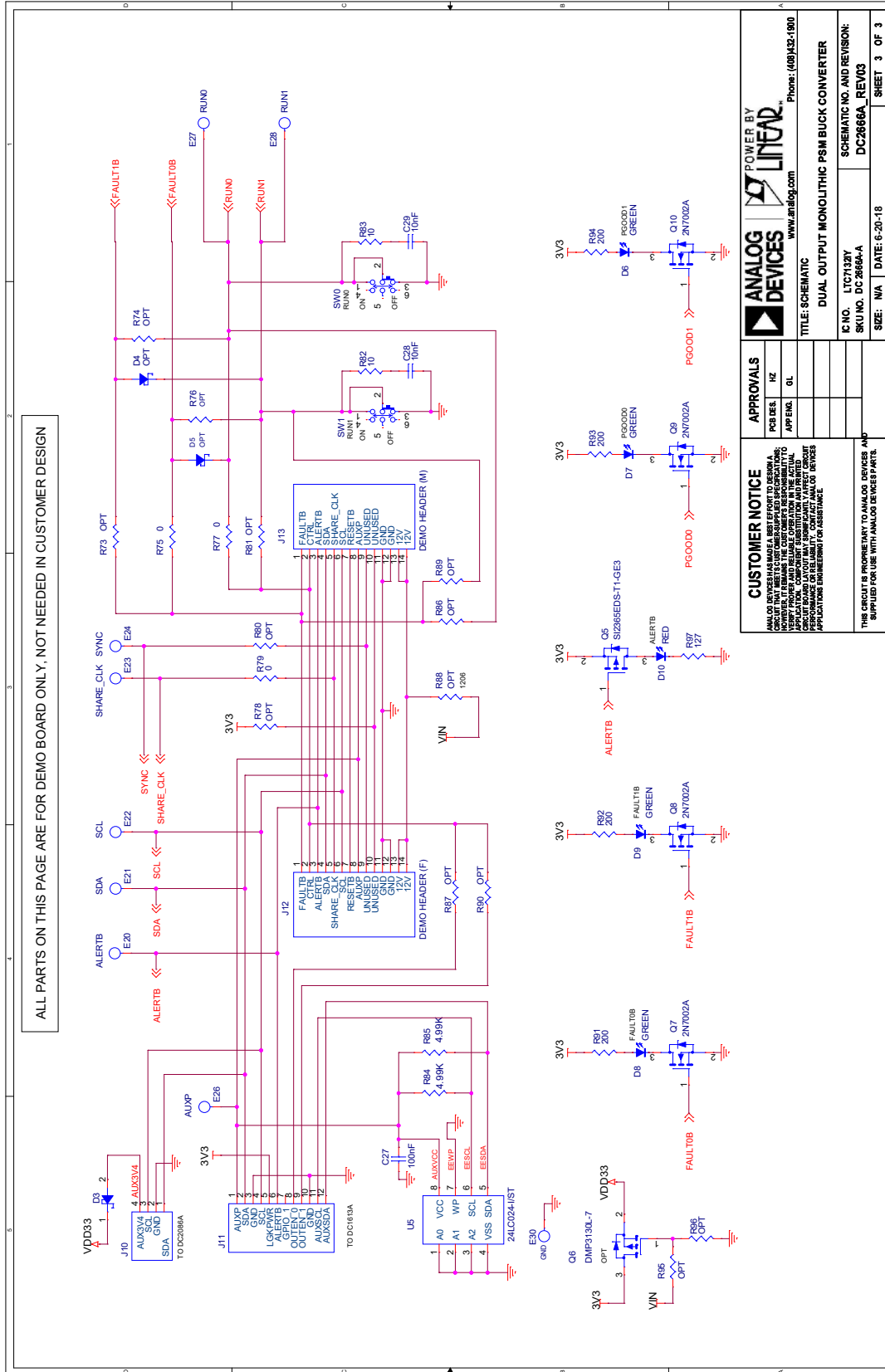

Figure 13c. DC2666A-A Demo Circuit Schematic, Sheet 3

SCHEMATIC DIAGRAM

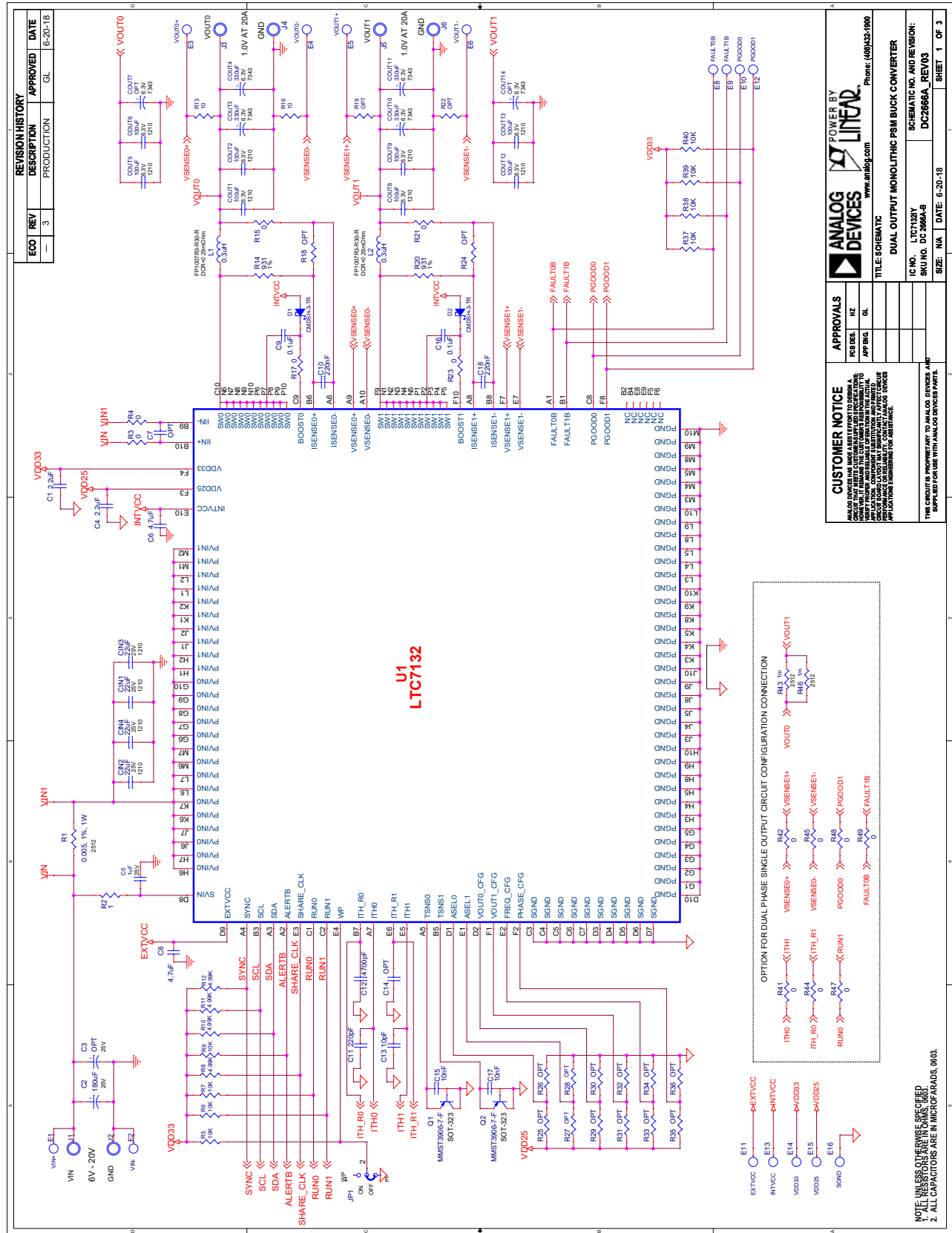

Figure 14a. DC2666A-B Demo Circuit Schematic, Sheet 1

DEMO MANUAL DC2666A-A/DC2666A-B

SCHEMATIC DIAGRAM

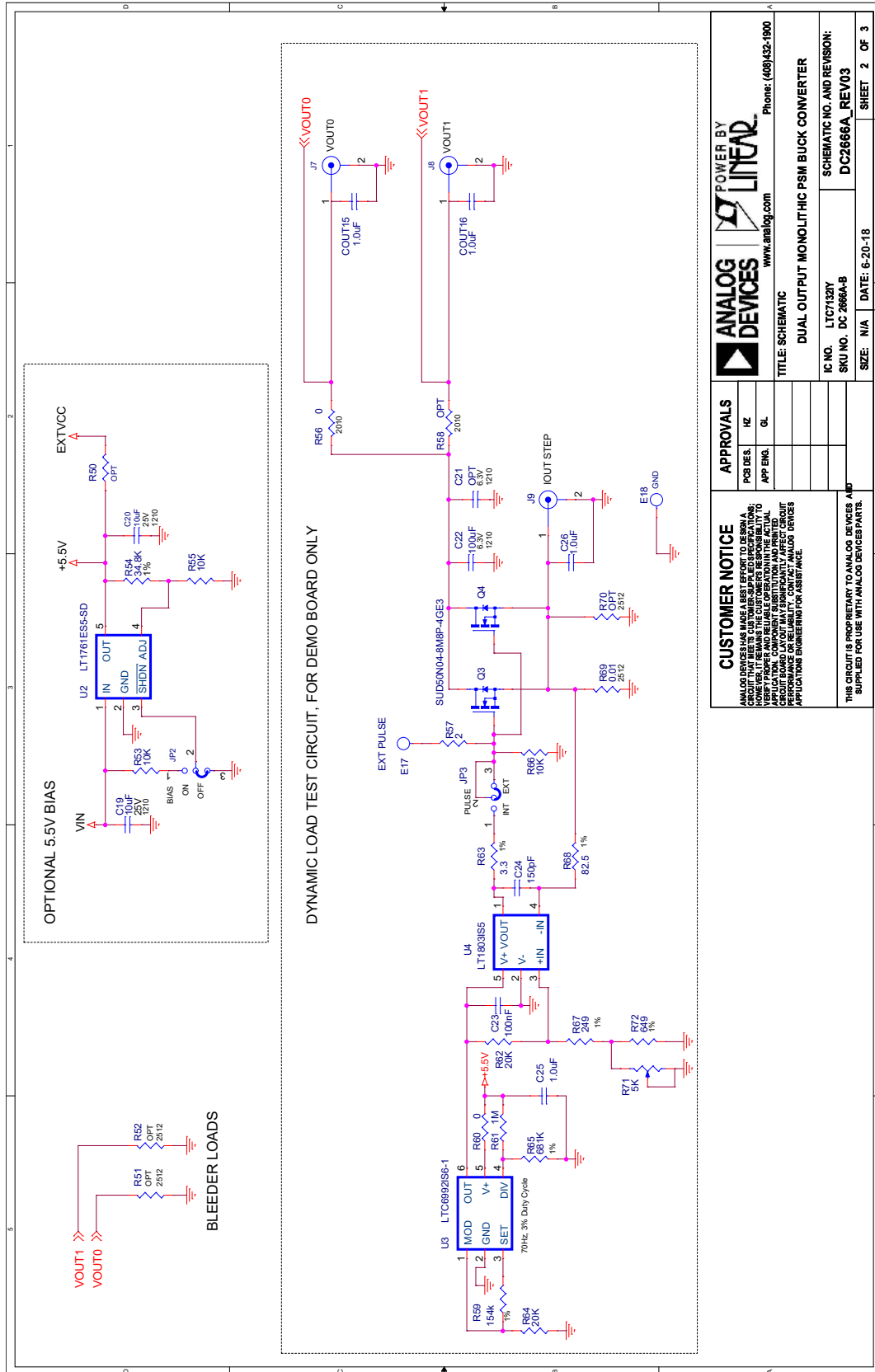
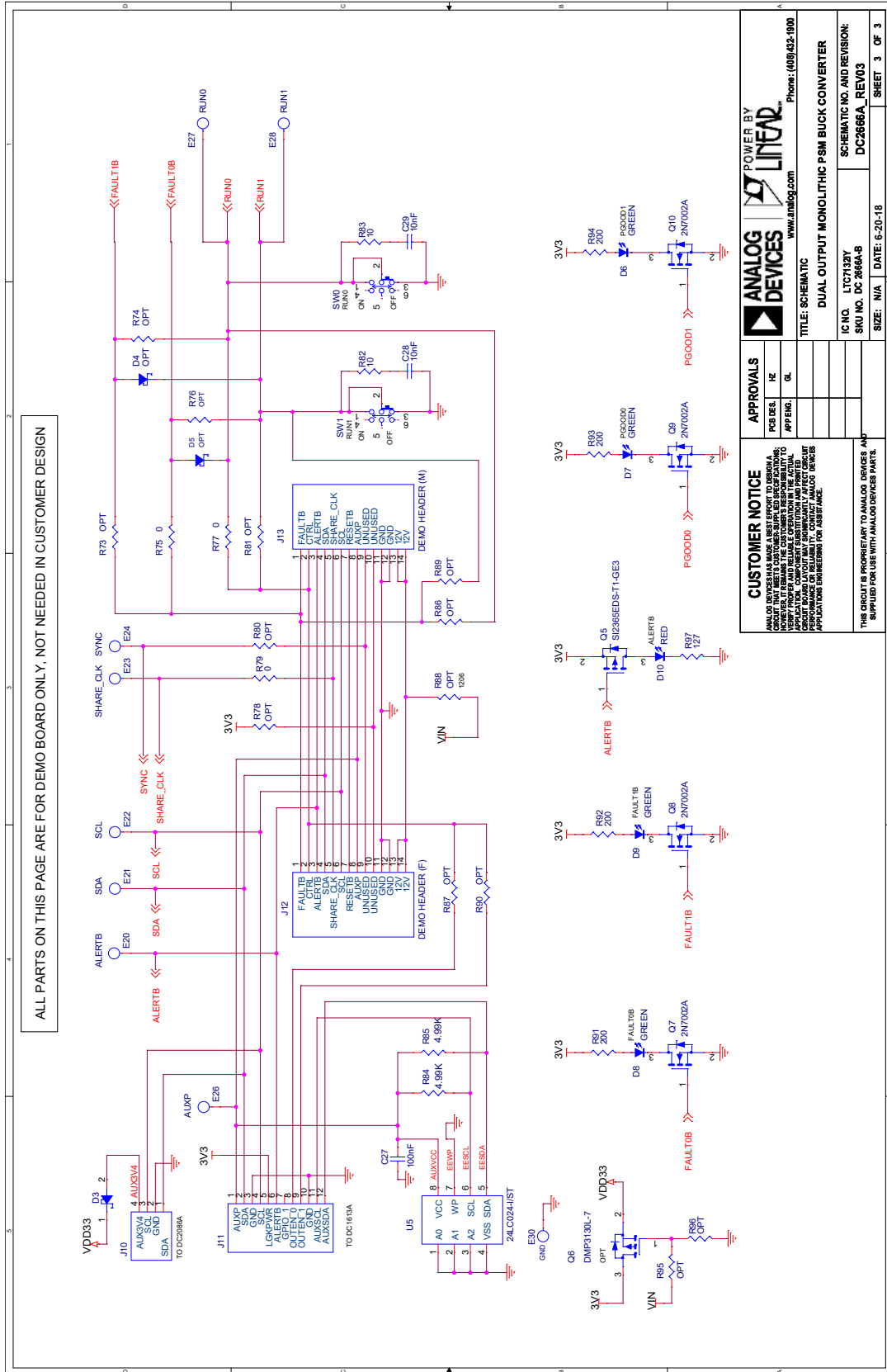

Figure 14b. DC2666A-B Demo Circuit Schematic, Sheet 2

SCHEMATIC DIAGRAM



POWER BY

 www.analog.com Phone: (609) 435-1900

CUSTOMER NOTICE
 ANALOG DEVICES HAS MADE BEST EFFORT TO DESIGN A DEMO BOARD THAT IS EASY TO USE AND UNDERSTAND. HOWEVER, IT REMAINS THE CUSTOMER'S RESPONSIBILITY TO VERIFY THE BOARD LAYOUT AND WIRE SCHEMATIC FOR THEIR APPLICATIONS AND TO PROVIDE THE NECESSARY APPLICATIONS ENGINEERING FOR ASSET FACE.

APPROVALS

PCB DES.	IZ
APP ENG.	OL

TITLE: SCHEMATIC
IC NO.: LTC1132Y
SKU NO.: DC 2666A-B
DATE: 6-20-18
SIZE: N/A
SHEET: 3 OF 3

DUAL OUTPUT MONOLITHIC PSM BUCK CONVERTER
SCHEMATIC NO. AND REVISION: DC2666A_REV03

THIS CIRCUIT IS PROPRIETARY TO ANALOG DEVICES AND IS SUPPLIED FOR USE WITH ANALOG DEVICES PARTS.

Figure 14c. DC2666A-B Demo Circuit Schematic, Sheet 3

DEMO MANUAL

DC2666A-A/DC2666A-B



ESD Caution

ESD (electrostatic discharge) sensitive device. Charged devices and circuit boards can discharge without detection. Although this product features patented or proprietary protection circuitry, damage may occur on devices subjected to high energy ESD. Therefore, proper ESD precautions should be taken to avoid performance degradation or loss of functionality.

Legal Terms and Conditions

By using the evaluation board discussed herein (together with any tools, components documentation or support materials, the "Evaluation Board"), you are agreeing to be bound by the terms and conditions set forth below ("Agreement") unless you have purchased the Evaluation Board, in which case the Analog Devices Standard Terms and Conditions of Sale shall govern. Do not use the Evaluation Board until you have read and agreed to the Agreement. Your use of the Evaluation Board shall signify your acceptance of the Agreement. This Agreement is made by and between you ("Customer") and Analog Devices, Inc. ("ADI"), with its principal place of business at One Technology Way, Norwood, MA 02062, USA. Subject to the terms and conditions of the Agreement, ADI hereby grants to Customer a free, limited, personal, temporary, non-exclusive, non-sublicensable, non-transferable license to use the Evaluation Board FOR EVALUATION PURPOSES ONLY. Customer understands and agrees that the Evaluation Board is provided for the sole and exclusive purpose referenced above, and agrees not to use the Evaluation Board for any other purpose. Furthermore, the license granted is expressly made subject to the following additional limitations: Customer shall not (i) rent, lease, display, sell, transfer, assign, sublicense, or distribute the Evaluation Board; and (ii) permit any Third Party to access the Evaluation Board. As used herein, the term "Third Party" includes any entity other than ADI, Customer, their employees, affiliates and in-house consultants. The Evaluation Board is NOT sold to Customer; all rights not expressly granted herein, including ownership of the Evaluation Board, are reserved by ADI. CONFIDENTIALITY. This Agreement and the Evaluation Board shall all be considered the confidential and proprietary information of ADI. Customer may not disclose or transfer any portion of the Evaluation Board to any other party for any reason. Upon discontinuation of use of the Evaluation Board or termination of this Agreement, Customer agrees to promptly return the Evaluation Board to ADI. ADDITIONAL RESTRICTIONS. Customer may not disassemble, decompile or reverse engineer chips on the Evaluation Board. Customer shall inform ADI of any occurred damages or any modifications or alterations it makes to the Evaluation Board, including but not limited to soldering or any other activity that affects the material content of the Evaluation Board. Modifications to the Evaluation Board must comply with applicable law, including but not limited to the RoHS Directive. TERMINATION. ADI may terminate this Agreement at any time upon giving written notice to Customer. Customer agrees to return to ADI the Evaluation Board at that time. LIMITATION OF LIABILITY. THE EVALUATION BOARD PROVIDED HEREUNDER IS PROVIDED "AS IS" AND ADI MAKES NO WARRANTIES OR REPRESENTATIONS OF ANY KIND WITH RESPECT TO IT. ADI SPECIFICALLY DISCLAIMS ANY REPRESENTATIONS, ENDORSEMENTS, GUARANTEES, OR WARRANTIES, EXPRESS OR IMPLIED, RELATED TO THE EVALUATION BOARD INCLUDING, BUT NOT LIMITED TO, THE IMPLIED WARRANTY OF MERCHANTABILITY, TITLE, FITNESS FOR A PARTICULAR PURPOSE OR NON-INFRINGEMENT OF INTELLECTUAL PROPERTY RIGHTS. IN NO EVENT WILL ADI AND ITS LICENSORS BE LIABLE FOR ANY INCIDENTAL, SPECIAL, INDIRECT, OR CONSEQUENTIAL DAMAGES RESULTING FROM CUSTOMER'S POSSESSION OR USE OF THE EVALUATION BOARD, INCLUDING BUT NOT LIMITED TO LOST PROFITS, DELAY COSTS, LABOR COSTS OR LOSS OF GOODWILL. ADI'S TOTAL LIABILITY FROM ANY AND ALL CAUSES SHALL BE LIMITED TO THE AMOUNT OF ONE HUNDRED US DOLLARS (\$100.00). EXPORT. Customer agrees that it will not directly or indirectly export the Evaluation Board to another country, and that it will comply with all applicable United States federal laws and regulations relating to exports. GOVERNING LAW. This Agreement shall be governed by and construed in accordance with the substantive laws of the Commonwealth of Massachusetts (excluding conflict of law rules). Any legal action regarding this Agreement will be heard in the state or federal courts having jurisdiction in Suffolk County, Massachusetts, and Customer hereby submits to the personal jurisdiction and venue of such courts. The United Nations Convention on Contracts for the International Sale of Goods shall not apply to this Agreement and is expressly disclaimed.

Rev. 0