

LDS0705

Shielded metalized drum core power inductors

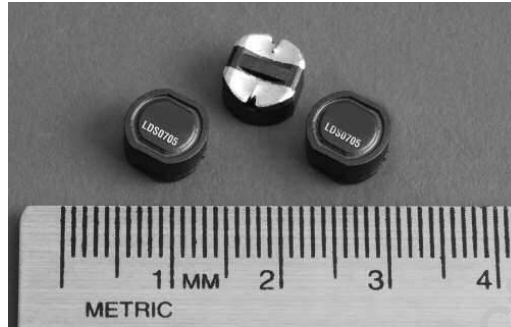

Product features

- 7.8 mm x 7.0 mm x 5.0 mm shielded drum core
- Ferrite core material
- Metalized core mounting utilizes board space
- Inductance range from 0.82 μ H to 470 μ H
- Current range from 0.368 A to 8.57 A
- Frequency range up to 1 MHz

Applications

- Buck or Boost Inductor
- Noise filtering and output filter chokes
- Battery Power, DC-DC converters
- Notebook and laptop power
- Hand held devices
- Media players

Environmental data

- Storage temperature range (component): -40 °C to +125 °C
- Operating temperature range: -40 °C to +125 °C (ambient plus self-temperature rise)
- Solder reflow temperature: J-STD-020 (latest revision) compliant



Discontinued, Effective October 2018 or until inventory is depleted. No replacement available. DRA74-R possible alternate solution.

Product specifications

Part Number	Rated Inductance (μH)	OCL (1) μH	I _{rms} (2) (A)	I _{sat} (3) (A)	DCR (Ω) @+20 °C (Typical)	K-factor (4)
LDS0705-R82M-R	0.82	0.861±20%	7.68	8.57	0.0040	24.8
LDS0705-1R5M-R	1.5	1.42±20%	6.17	6.67	0.0061	19.3
LDS0705-2R2M-R	2.2	2.13±20%	5.06	5.45	0.009	15.8
LDS0705-3R3M-R	3.3	2.97±20%	4.19	4.62	0.013	13.4
LDS0705-4R7M-R	4.7	5.08±20%	3.32	3.53	0.021	10.2
LDS0705-6R8M-R	6.8	6.34±20%	3.11	3.16	0.024	9.2
LDS0705-8R2M-R	8.2	7.75±20%	2.67	2.86	0.033	8.3
LDS0705-100M-R	10.0	9.30±20%	2.54	2.61	0.036	7.6
LDS0705-150M-R	15.0	14.78±20%	2.04	2.07	0.056	6.0
LDS0705-220M-R	22.0	21.53±20%	1.66	1.71	0.084	5.0
LDS0705-330M-R	33.0	32.50±20%	1.48	1.40	0.107	4.0
LDS0705-470M-R	47.0	45.71±20%	1.21	1.18	0.153	3.4
LDS0705-680M-R	68.0	69.76±20%	0.985	0.952	0.240	2.8
LDS0705-820M-R	82.0	83.67±20%	0.850	0.870	0.323	2.5
LDS0705-101M-R	100.0	98.9±20%	0.808	0.800	0.357	2.3
LDS0705-151M-R	150.0	152.0±20%	0.649	0.645	0.554	1.9
LDS0705-221M-R	220.0	216.5±20%	0.584	0.541	0.68	1.6
LDS0705-331M-R	330.0	329.9±20%	0.470	0.438	1.06	1.3
LDS0705-471M-R	470.0	467.0±20%	0.387	0.368	1.56	1.1

- (1) Open Circuit Inductance Test Parameters: 100 kHz, 0.1 V, 0.0 Adc.
 (2) I_{rms}: DC current for an approximate ΔT of 30 °C without core loss. Derating is necessary for AC currents. PCB layout, trace thickness and width, air-flow, and proximity of other heat generating components will affect the temperature rise. It is recommended that the temperature of the part not exceed +125 °C under worst case operating conditions verified in the end application.
 (3) I_{sat} Amperes peak for approximately 15% rolloff (@+25 °C)
 (4) K-factor: Used to determine B p-p for core loss (see graph).
 $B_{p-p} = K \cdot L \cdot \Delta I$, B p-p(mT), K: (K factor from table), L: (Inductance in μH), ΔI(Peak to peak ripple current in Amps).
 (5) Part Number Definition: LDS0705-xxx-R
 LDS0705 = Product code and size; -xxx = Inductance value in uH;
 R = decimal point; If no R is present, last character equals number of zeros.
 M = Inductance tolerance +/- 20% -R suffix = RoHS compliant

Dimensions- mm

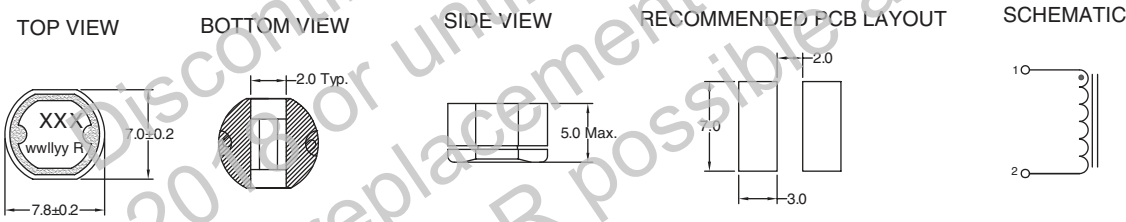

Marking: xxx = Inductance in uH. R = decimal point. If no R is present last character equals number of zeros. wwlllyy = Date code. R = Revision level.
 Do not route traces or vias underneath the inductor

Packaging information- mm

Parts packaged on 13" Diameter reel,
1,000 parts per reel.

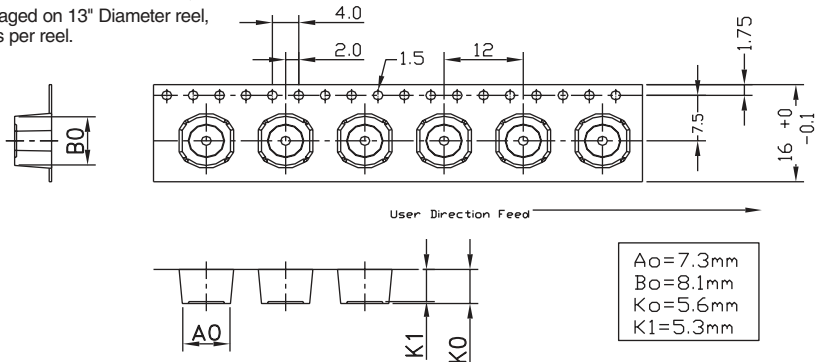

Temperature rise vs. total loss

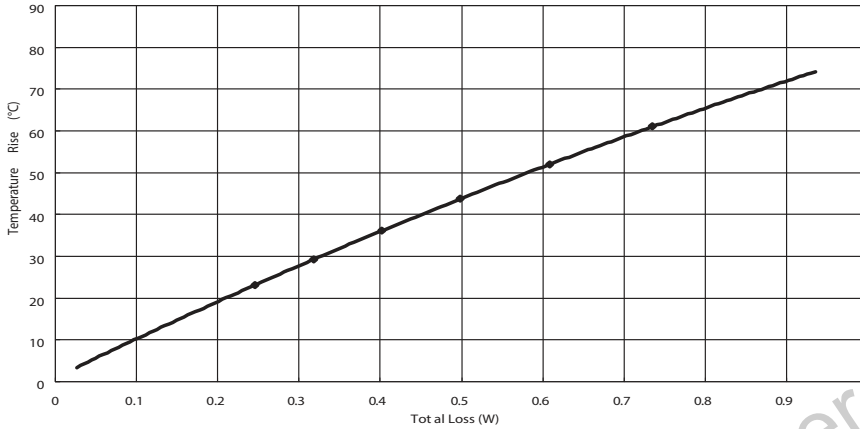

Core loss vs Bp-p

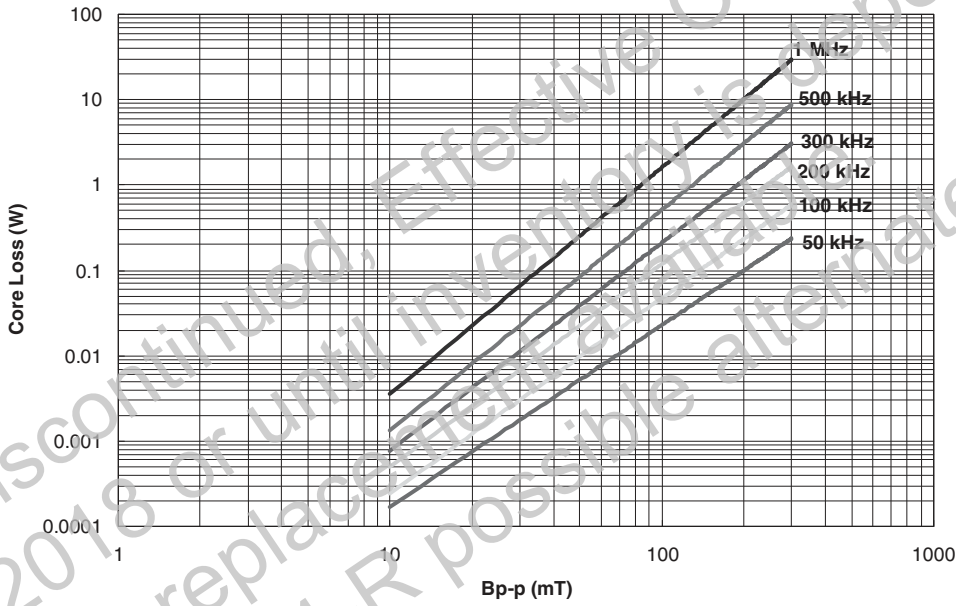

Inductance characteristics

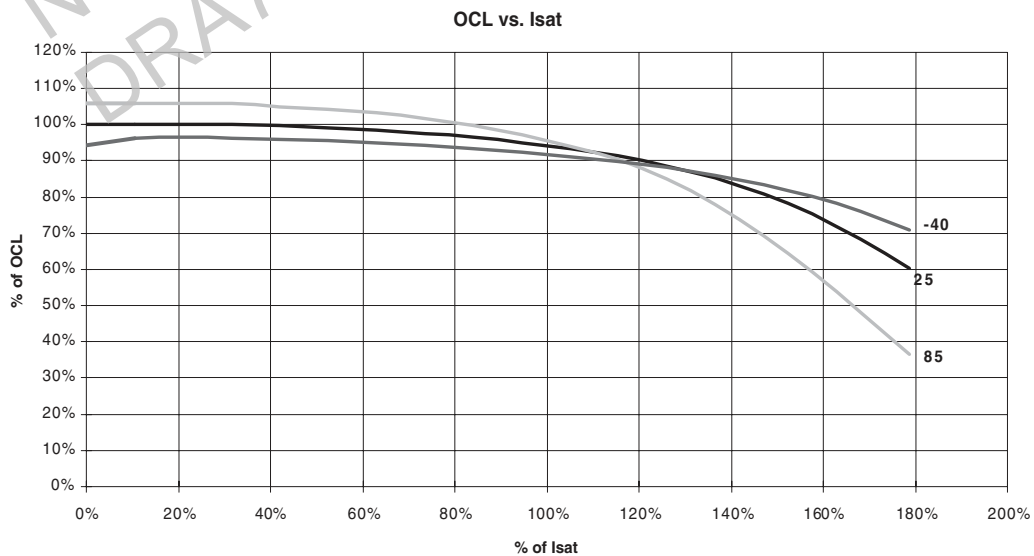

Solder Reflow Profile

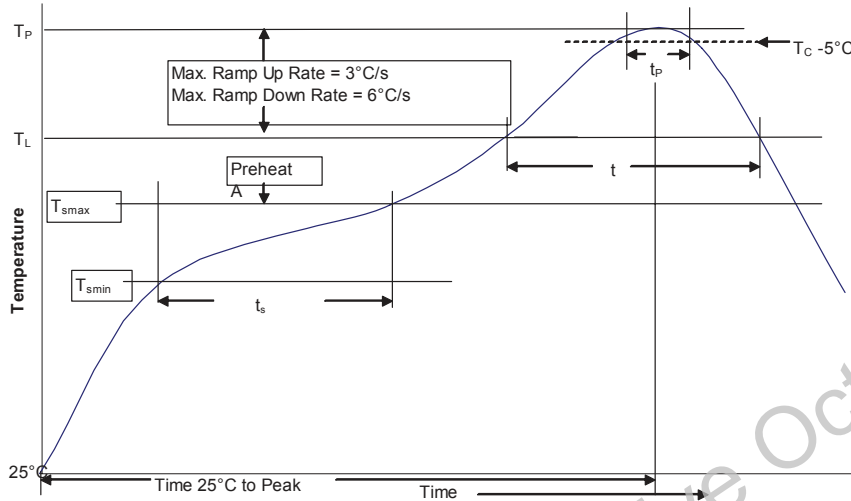

Table 1 - Standard SnPb Solder (T_p)

Package Thickness	Volume mm^3 <350	Volume mm^3 ≥ 350
<2.5mm	235°C	220°C
$\geq 2.5\text{mm}$	220°C	220°C

Table 2 - Lead (Pb) Free Solder (T_p)

Package Thickness	Volume mm^3 <350	Volume mm^3 350 - 2000	Volume mm^3 >2000
<1.6mm	260°C	260°C	260°C
1.6 – 2.5mm	260°C	250°C	245°C
>2.5mm	250°C	245°C	245°C

Reference JDEC J-STD-020

Profile Feature	Standard SnPb Solder	Lead (Pb) Free Solder
Preheat and Soak	<ul style="list-style-type: none"> Temperature min. (T_{smin}) Temperature max. (T_{smax}) Time (T_{smin} to T_{smax}) (t_s) 	<ul style="list-style-type: none"> 100°C 150°C 60-120 Seconds
Average ramp up rate T_{smax} to T_p	3°C/ Second Max.	3°C/ Second Max.
Liquidous temperature (T_l)	183°C	217°C
Time at liquidous (t_l)	60-150 Seconds	60-150 Seconds
Peak package body temperature (T_p)*	Table 1	Table 2
Time (t_p)** within 5 °C of the specified classification temperature (T_c)	20 Seconds**	30 Seconds**
Average ramp-down rate (T_p to T_{smax})	6°C/ Second Max.	6°C/ Second Max.
Time 25°C to Peak Temperature	6 Minutes Max.	8 Minutes Max.

* Tolerance for peak profile temperature (T_p) is defined as a supplier minimum and a user maximum.

** Tolerance for time at peak profile temperature (t_p) is defined as a supplier minimum and a user maximum.

Life Support Policy: Eaton does not authorize the use of any of its products for use in life support devices or systems without the express written approval of an officer of the Company. Life support systems are devices which support or sustain life, and whose failure to perform, when properly used in accordance with instructions for use provided in the labeling, can be reasonably expected to result in significant injury to the user.

Eaton reserves the right, without notice, to change design or construction of any products and to discontinue or limit distribution of any products. Eaton also reserves the right to change or update, without notice, any technical information contained in this bulletin.

Eaton
Electronics Division
1000 Eaton Boulevard
Cleveland, OH 44122
United States
www.eaton.com/electronics

© 2017 Eaton
All Rights Reserved
Printed in USA
Publication No. 4142
July 2017