

74LVC4T3144

4-bit dual supply buffer/line driver; 3-state

Rev. 2 — 3 August 2023

Product data sheet

1. General description

The 74LVC4T3144 is a 4-bit, dual-supply level translating buffer with 3-state outputs. It features four data inputs (An and B4), four data outputs (YBn and YA4), and an output enable input (\overline{OE}). The device is configured to translate three inputs from $V_{CC(A)}$ to $V_{CC(B)}$ and one input from $V_{CC(B)}$ to $V_{CC(A)}$. \overline{OE} , An and YA4 are referenced to $V_{CC(A)}$ and YBn and B4 are referenced to $V_{CC(B)}$. A HIGH on \overline{OE} causes the outputs to assume a high-impedance OFF-state.

The device is fully specified for partial power-down applications using I_{OFF} . The I_{OFF} circuitry disables outputs, preventing any damaging backflow current through the device when it is powered down. In suspend mode when either $V_{CC(A)}$ or $V_{CC(B)}$ are at GND level, all outputs are in the high-impedance OFF-state.

2. Features and benefits

- Wide supply voltage range:
 - $V_{CC(A)}$: 1.2 V to 5.5 V
 - $V_{CC(B)}$: 1.2 V to 5.5 V
- High noise immunity
- Maximum data rates:
 - 200 Mbps (3.3 V to 5.0 V translation)
 - 140 Mbps (translate to 3.3 V)
 - 100 Mbps (translate to 2.5 V)
 - 75 Mbps (translate to 1.8 V)
 - 60 Mbps (translate to 1.5 V)
- Suspend mode
- Latch-up performance exceeds 100 mA per JESD 78B Class II
- ± 24 mA output drive ($V_{CC} = 3.0$ V)
- Inputs accept voltages up to 5.5 V
- Low power consumption: 30 μ A maximum I_{CC}
- I_{OFF} circuitry provides partial Power-down mode operation
- Complies with JEDEC standards:
 - JESD8-11A (1.4 V to 1.6 V)
 - JESD8-7 (1.65 V to 1.95 V)
 - JESD8-5 (2.3 V to 2.7 V)
 - JESD8C (3.0 V to 3.6 V)
 - JESD12-6 (4.5 V to 5.5 V)
- ESD protection:
 - HBM: ANSI/ESDA/JEDEC JS-001 class 2 exceeds 2000 V
 - CDM: ANSI/ESDA/JEDEC JS-002 class C3 exceeds 1000 V
- Specified from -40 °C to +85 °C and -40 °C to +125 °C

3. Ordering information

Table 1. Ordering information

Type number	Package			Version
	Temperature range	Name	Description	
74LVC4T3144PW	-40 °C to +125 °C	TSSOP14	plastic thin shrink small outline package; 14 leads; body width 4.4 mm	SOT402-1

4. Functional diagram

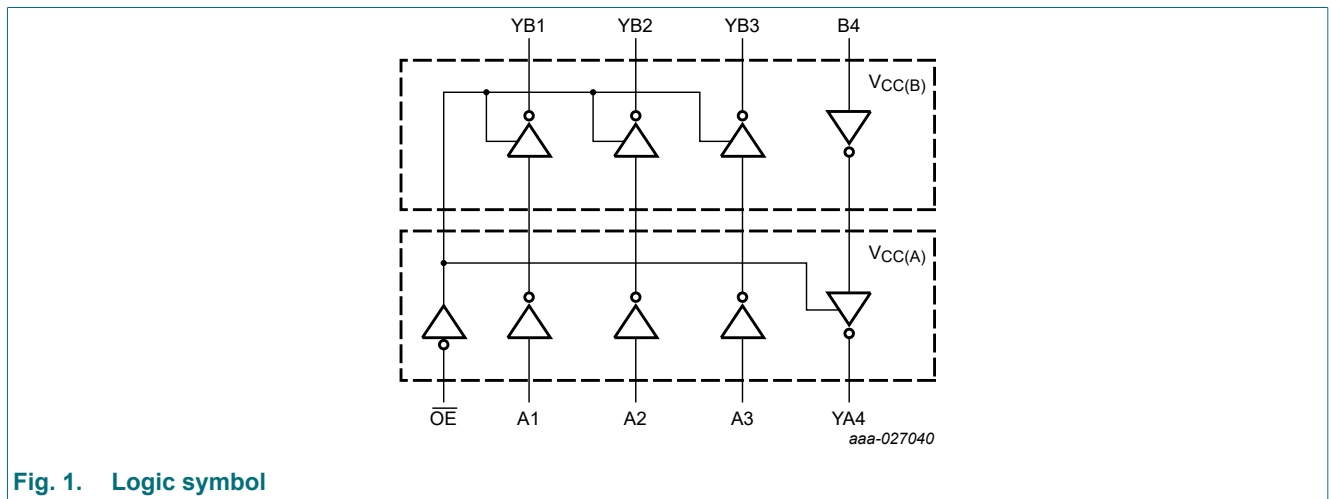
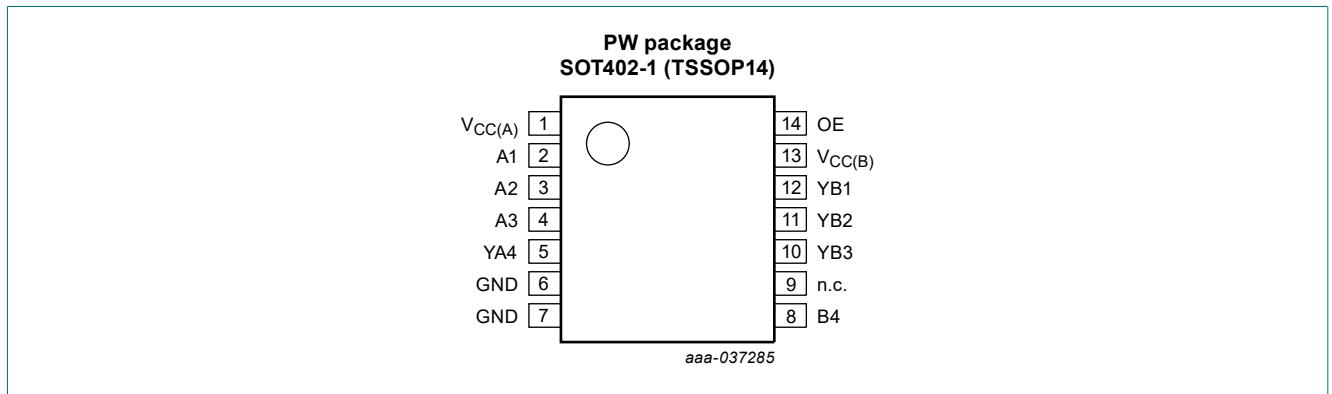

Fig. 1. Logic symbol

5. Pinning information

5.1. Pinning



5.2. Pin description

Table 2. Pin description

Symbol	Pin	Description
$V_{CC(A)}$	1	supply voltage A (An inputs, YA4 output and \overline{OE} input are referenced to $V_{CC(A)}$)
A1, A2, A3	2, 3, 4	data input
YA4	5	data output
GND	6, 7	ground (0 V)
B4	8	data input
n.c.	9	not connected
YB3, YB2, YB1	10, 11, 12	data output
$V_{CC(B)}$	13	supply voltage B (YBn outputs and B4 input are referenced to $V_{CC(B)}$)
\overline{OE}	14	output enable input (active LOW)

6. Functional description

Table 3. Function table [1]

Supply voltage	Control	Input	Output
$V_{CC(A)}$, $V_{CC(B)}$	\overline{OE} [2]	An, B4[2]	YBn, YA4[2]
1.2 V to 5.5 V	L	L	L
1.2 V to 5.5 V	L	H	H
1.2 V to 5.5 V	H	X	Z
GND[3]	X	X	Z

[1] H = HIGH voltage level; L = LOW voltage level; X = don't care; Z = high-impedance OFF-state.

[2] The An inputs, YA4 output and \overline{OE} input are referenced to $V_{CC(A)}$; The YBn outputs and B4 input are referenced to $V_{CC(B)}$.

[3] If at least one of $V_{CC(A)}$ or $V_{CC(B)}$ is at GND level, the device goes into suspend mode.

7. Limiting values

Table 4. Limiting values

In accordance with the Absolute Maximum Rating System (IEC 60134). Voltages are referenced to GND (ground = 0 V).

Symbol	Parameter	Conditions	Min	Max	Unit
$V_{CC(A)}$	supply voltage A		-0.5	+6.5	V
$V_{CC(B)}$	supply voltage B		-0.5	+6.5	V
I_{IK}	input clamping current	$V_I < 0$ V	-50	-	mA
V_I	input voltage	[1]	-0.5	+6.5	V
I_{OK}	output clamping current	$V_O < 0$ V	-50	-	mA
V_O	output voltage	Active mode [1] [2] [3]	-0.5	$V_{CCO} + 0.5$	V
		Suspend or 3-state mode [1]	-0.5	+6.5	V
I_O	output current	$V_O = 0$ V to V_{CCO} [2]	-	± 50	mA
I_{CC}	supply current	$I_{CC(A)}$ or $I_{CC(B)}$; per V_{CC} pin	-	100	mA
I_{GND}	ground current	per GND pin	-100	-	mA
T_{stg}	storage temperature		-65	+150	°C
P_{tot}	total power dissipation	$T_{amb} = -40$ °C to $+125$ °C [4]	-	500	mW

- [1] The minimum input voltage ratings and output voltage ratings may be exceeded if the input and output current ratings are observed.
 [2] V_{CCO} is the supply voltage associated with the output port.
 [3] $V_{CCO} + 0.5$ V should not exceed 6.5 V.
 [4] For SOT402-1 (TSSOP14) package: P_{tot} derates linearly with 7.3 mW/K above 81 °C.

8. Recommended operating conditions

Table 5. Recommended operating conditions

Symbol	Parameter	Conditions	Min	Max	Unit
$V_{CC(A)}$	supply voltage A		1.2	5.5	V
$V_{CC(B)}$	supply voltage B		1.2	5.5	V
V_I	input voltage		0	5.5	V
V_O	output voltage	Active mode [1]	0	V_{CCO}	V
		Suspend or 3-state mode	0	5.5	V
T_{amb}	ambient temperature		-40	+125	°C
$\Delta t/\Delta V$	input transition rise and fall rate	$V_{CCI} = 1.2$ V [2]	-	20	ns/V
		$V_{CCI} = 1.4$ V to 1.95 V	-	20	ns/V
		$V_{CCI} = 2.3$ V to 2.7 V	-	20	ns/V
		$V_{CCI} = 3$ V to 3.6 V	-	10	ns/V
		$V_{CCI} = 4.5$ V to 5.5 V	-	5	ns/V

- [1] V_{CCO} is the supply voltage associated with the output port.
 [2] V_{CCI} is the supply voltage associated with the input port.

9. Static characteristics

Table 6. Typical static characteristics at $T_{amb} = 25\text{ °C}$

At recommended operating conditions; voltages are referenced to GND (ground = 0 V).

Symbol	Parameter	Conditions	Min	Typ	Max	Unit
V_{OH}	HIGH-level output voltage	YBn, YA4; $V_I = V_{IH}$ or V_{IL} [1]				
		$I_O = -3\text{ mA}$; $V_{CCO} = 1.2\text{ V}$	-	1.09	-	V
V_{OL}	LOW-level output voltage	YBn, YA4; $V_I = V_{IH}$ or V_{IL}				
		$I_O = 3\text{ mA}$; $V_{CCO} = 1.2\text{ V}$ [1]	-	0.07	-	V
I_I	input leakage current	An, B4 and \overline{OE} input; $V_I = 0\text{ V}$ to 5.5 V ; $V_{CCI} = 1.2\text{ V}$ to 5.5 V [2]	-	-	± 1	μA
I_{OZ}	OFF-state output current	YBn, YA4; $V_O = 0\text{ V}$ or V_{CCO} ; $V_{CCO} = 1.2\text{ V}$ to 5.5 V [1]	-	-	± 1	μA
		YBn, YA4; suspend mode; $V_O = 0\text{ V}$ or V_{CCO} ; $V_{CC(A)} = 5.5\text{ V}$; $V_{CC(B)} = 0\text{ V}$ [1]	-	-	± 1	μA
		YBn, YA4; suspend mode; $V_O = 0\text{ V}$ or V_{CCO} ; $V_{CC(A)} = 0\text{ V}$; $V_{CC(B)} = 5.5\text{ V}$ [1]	-	-	± 1	μA
I_{OFF}	power-off leakage current	A port; V_I or $V_O = 0\text{ V}$ to 5.5 V ; $V_{CC(A)} = 0\text{ V}$; $V_{CC(B)} = 1.2\text{ V}$ to 5.5 V	-	-	± 1	μA
		B port; V_I or $V_O = 0\text{ V}$ to 5.5 V ; $V_{CC(B)} = 0\text{ V}$; $V_{CC(A)} = 1.2\text{ V}$ to 5.5 V	-	-	± 1	μA
C_I	input capacitance	An, B4 and \overline{OE} input; $V_I = 0\text{ V}$ or 3.3 V ; $V_{CC(A)} = 3.3\text{ V}$; $V_{CC(B)} = 3.3\text{ V}$	-	3	-	pF
C_O	output capacitance	YBn, YA4 output; $V_O = 0\text{ V}$ or 3.3 V ; \overline{OE} input = 3.3 V ; $V_{CC(A)} = 3.3\text{ V}$; $V_{CC(B)} = 3.3\text{ V}$	-	6.5	-	pF

[1] V_{CCO} is the supply voltage associated with the output port.

[2] V_{CCI} is the supply voltage associated with the input port.

Table 7. Static characteristics

At recommended operating conditions; voltages are referenced to GND (ground = 0 V).

Symbol	Parameter	Conditions	-40 °C to +85 °C		-40 °C to +125 °C		Unit
			Min	Max	Min	Max	
V_{IH}	HIGH-level input voltage	data input [1]					
		$V_{CCI} = 1.2\text{ V}$	$0.8V_{CCI}$	-	$0.8V_{CCI}$	-	V
		$V_{CCI} = 1.4\text{ V}$ to 1.95 V	$0.65V_{CCI}$	-	$0.65V_{CCI}$	-	V
		$V_{CCI} = 2.3\text{ V}$ to 2.7 V	1.7	-	1.7	-	V
		$V_{CCI} = 3.0\text{ V}$ to 3.6 V	2.0	-	2.0	-	V
		$V_{CCI} = 4.5\text{ V}$ to 5.5 V	$0.7V_{CCI}$	-	$0.7V_{CCI}$	-	V
		\overline{OE} input					
		$V_{CCI} = 1.2\text{ V}$	$0.8V_{CC(A)}$	-	$0.8V_{CC(A)}$	-	V
		$V_{CCI} = 1.4\text{ V}$ to 1.95 V	$0.65V_{CC(A)}$	-	$0.65V_{CC(A)}$	-	V
		$V_{CCI} = 2.3\text{ V}$ to 2.7 V	1.7	-	1.7	-	V
		$V_{CCI} = 3.0\text{ V}$ to 3.6 V	2.0	-	2.0	-	V
		$V_{CCI} = 4.5\text{ V}$ to 5.5 V	$0.7V_{CC(A)}$	-	$0.7V_{CC(A)}$	-	V

Symbol	Parameter	Conditions	-40 °C to +85 °C		-40 °C to +125 °C		Unit
			Min	Max	Min	Max	
V _{IL}	LOW-level input voltage	data input [1]					
		V _{CCI} = 1.2 V	-	0.2V _{CCI}	-	0.2V _{CCI}	V
		V _{CCI} = 1.4 V to 1.95 V	-	0.35V _{CCI}	-	0.35V _{CCI}	V
		V _{CCI} = 2.3 V to 2.7 V	-	0.7	-	0.7	V
		V _{CCI} = 3.0 V to 3.6 V	-	0.8	-	0.8	V
		V _{CCI} = 4.5 V to 5.5 V	-	0.3V _{CCI}	-	0.3V _{CCI}	V
		OE input					
		V _{CCI} = 1.2 V	-	0.2V _{CC(A)}	-	0.2V _{CC(A)}	V
		V _{CCI} = 1.4 V to 1.95 V	-	0.35V _{CC(A)}	-	0.35V _{CC(A)}	V
		V _{CCI} = 2.3 V to 2.7 V	-	0.7	-	0.7	V
		V _{CCI} = 3.0 V to 3.6 V	-	0.8	-	0.8	V
		V _{CCI} = 4.5 V to 5.5 V	-	0.3V _{CC(A)}	-	0.3V _{CC(A)}	V
V _{OH}	HIGH-level output voltage	V _I = V _{IH}					
		I _O = -100 µA; V _{CCO} = 1.2 V to 4.5 V [2]	V _{CCO} - 0.1	-	V _{CCO} - 0.1	-	V
		I _O = -6 mA; V _{CCO} = 1.4 V	1.0	-	1.0	-	V
		I _O = -8 mA; V _{CCO} = 1.65 V	1.2	-	1.2	-	V
		I _O = -12 mA; V _{CCO} = 2.3 V	1.9	-	1.9	-	V
		I _O = -24 mA; V _{CCO} = 3.0 V	2.4	-	2.4	-	V
		I _O = -24 mA; V _{CCO} = 4.5 V	3.85	-	3.85	-	V
I _O = -32 mA; V _{CCO} = 4.5 V	3.8	-	3.8	-	V		
V _{OL}	LOW-level output voltage	V _I = V _{IL} [2]					
		I _O = 100 µA; V _{CCO} = 1.2 V to 4.5 V	-	0.1	-	0.1	V
		I _O = 6 mA; V _{CCO} = 1.4 V	-	0.3	-	0.3	V
		I _O = 8 mA; V _{CCO} = 1.65 V	-	0.45	-	0.45	V
		I _O = 12 mA; V _{CCO} = 2.3 V	-	0.3	-	0.3	V
		I _O = 24 mA; V _{CCO} = 3.0 V	-	0.55	-	0.55	V
		I _O = 24 mA; V _{CCO} = 4.5 V	-	0.50	-	0.50	V
I _O = 32 mA; V _{CCO} = 4.5 V	-	0.55	-	0.55	V		
I _I	input leakage current	V _I = 0 V to 5.5 V; V _{CCI} = 1.2 V to 5.5 V	-	±2	-	±10	µA
I _{OZ}	OFF-state output current	V _O = 0 V or V _{CCO} ; V _{CCO} = 1.2 V to 5.5 V [2]	-	±2	-	±10	µA
		suspend mode; V _O = 0 V or V _{CCO} ; V _{CC(A)} = 5.5 V; V _{CC(B)} = 0 V [2]	-	±2	-	±10	µA
		suspend mode; V _O = 0 V or V _{CCO} ; V _{CC(A)} = 0 V; V _{CC(B)} = 5.5 V [2]	-	±2	-	±10	µA
I _{OFF}	power-off leakage current	A port; V _I or V _O = 0 V to 5.5 V; V _{CC(A)} = 0 V; V _{CC(B)} = 1.2 V to 5.5 V	-	±2	-	±10	µA
		B port; V _I or V _O = 0 V to 5.5 V; V _{CC(B)} = 0 V; V _{CC(A)} = 1.2 V to 5.5 V	-	±2	-	±10	µA

Symbol	Parameter	Conditions	-40 °C to +85 °C		-40 °C to +125 °C		Unit
			Min	Max	Min	Max	
I _{CC}	supply current	A port; V _I = 0 V or V _{CCI} ; I _O = 0 A [1]					
		V _{CC(A)} , V _{CC(B)} = 1.2 V to 5.5 V	-	15	-	20	μA
		V _{CC(A)} = 5.5 V; V _{CC(B)} = 0 V	-	15	-	20	μA
		V _{CC(A)} = 0 V; V _{CC(B)} = 5.5 V	-2	-	-4	-	μA
		B port; V _I = 0 V or V _{CCI} ; I _O = 0 A					
		V _{CC(A)} , V _{CC(B)} = 1.2 V to 5.5 V	-	15	-	20	μA
		V _{CC(B)} = 0 V; V _{CC(A)} = 5.5 V	-2	-	-4	-	μA
		V _{CC(B)} = 5.5 V; V _{CC(A)} = 0 V	-	15	-	20	μA
		A plus B port (I _{CC(A)} + I _{CC(B)}); I _O = 0 A; V _I = 0 V or V _{CCI}					
V _{CC(A)} , V _{CC(B)} = 1.2 V to 5.5 V	-	25	-	30	μA		
ΔI _{CC}	additional supply current	per input; V _{CC(A)} , V _{CC(B)} = 3.0 V to 5.5 V					
		OE input; OE input at V _{CC(A)} - 0.6 V; A port at V _{CC(A)} or GND; B port = open	-	50	-	75	μA
		A port; A port at V _{CC(A)} - 0.6 V; B port = open	-	50	-	75	μA
		B port; B port at V _{CC(B)} - 0.6 V; A port = open	-	50	-	75	μA

[1] V_{CCI} is the supply voltage associated with the input port.

[2] V_{CCO} is the supply voltage associated with the output port.

10. Dynamic characteristics

Table 8. Typical dynamic characteristics at $V_{CC(A)} = 1.2\text{ V}$ and $T_{amb} = 25\text{ °C}$ [1]

Voltages are referenced to GND (ground = 0 V); for test circuit see Fig. 4; for waveforms see Fig. 2 and Fig. 3.

Symbol	Parameter	Conditions	$V_{CC(B)}$						Unit
			1.2 V	1.5 V	1.8 V	2.5 V	3.3 V	5.0 V	
t_{pd}	propagation delay	An to YBn	15.6	11.6	9.8	7.8	6.9	6.3	ns
		B4 to YA4	15.6	14.5	14.0	13.5	13.3	13.8	ns
t_{dis}	disable time	\overline{OE} to YA4	8.7	8.7	8.7	8.7	8.7	8.7	ns
		\overline{OE} to YBn	11.9	9.2	8.7	7.4	7.7	6.8	ns
t_{en}	enable time	\overline{OE} to YA4	17.5	17.5	17.5	17.5	17.5	17.5	ns
		\overline{OE} to YBn	18.3	13.6	11.5	9.5	8.8	8.5	ns

[1] t_{pd} is the same as t_{PLH} and t_{PHL} ; t_{dis} is the same as t_{PLZ} and t_{PHZ} ; t_{en} is the same as t_{PZL} and t_{PZH} .

Table 9. Typical dynamic characteristics at $V_{CC(B)} = 1.2\text{ V}$ and $T_{amb} = 25\text{ °C}$ [1]

Voltages are referenced to GND (ground = 0 V); for test circuit see Fig. 4; for waveforms see Fig. 2 and Fig. 3.

Symbol	Parameter	Conditions	$V_{CC(A)}$						Unit
			1.2 V	1.5 V	1.8 V	2.5 V	3.3 V	5.0 V	
t_{pd}	propagation delay	An to YBn	15.6	14.5	14.0	13.5	13.3	13.1	ns
		B4 to YA4	15.6	11.6	9.8	7.8	6.9	6.3	ns
t_{dis}	disable time	\overline{OE} to YA4	8.7	6.1	5.5	3.9	4.1	2.9	ns
		\overline{OE} to YBn	11.9	10.5	9.9	9.2	8.9	8.4	ns
t_{en}	enable time	\overline{OE} to YA4	17.5	11.6	9.0	5.7	4.6	3.8	ns
		\overline{OE} to YBn	18.3	17.0	16.4	15.8	15.6	15.4	ns

[1] t_{pd} is the same as t_{PLH} and t_{PHL} ; t_{dis} is the same as t_{PLZ} and t_{PHZ} ; t_{en} is the same as t_{PZL} and t_{PZH} .

Table 10. Typical power dissipation capacitance at $V_{CC(A)} = V_{CC(B)}$ and $T_{amb} = 25\text{ °C}$ [1] [2]

Voltages are referenced to GND (ground = 0 V).

Symbol	Parameter	Conditions	$V_{CC(A)}$ and $V_{CC(B)}$						Unit
			1.2 V	1.5 V	1.8 V	2.5 V	3.3 V	5.0 V	
C_{PD}	power dissipation capacitance	inputs An, B4	0.5	0.5	0.5	0.7	0.9	1.3	pF
		outputs YBn, YA4	12	12	12	12	12	12	pF

[1] C_{PD} is used to determine the dynamic power dissipation (P_D in μW).

$$P_D = C_{PD} \times V_{CC}^2 \times f_i \times N + \Sigma(C_L \times V_{CC}^2 \times f_o) \text{ where:}$$

f_i = input frequency in MHz;

f_o = output frequency in MHz;

C_L = load capacitance in pF;

V_{CC} = supply voltage in V;

N = number of inputs switching;

$\Sigma(C_L \times V_{CC}^2 \times f_o)$ = sum of the outputs.

[2] $f_i = 10\text{ MHz}$; $V_i = \text{GND to } V_{CC}$; $t_r = t_f = 1\text{ ns}$; $C_L = 0\text{ pF}$; $R_L = \infty\ \Omega$.

Table 11. Dynamic characteristics for temperature range -40 °C to +85 °C [1]

Voltages are referenced to GND (ground = 0 V); for test circuit see Fig. 4; for waveforms see Fig. 2 and Fig. 3.

Symbol	Parameter	Conditions	V _{CC(B)}										Unit
			1.5 V ± 0.1 V		1.8 V ± 0.15 V		2.5 V ± 0.2 V		3.3 V ± 0.3 V		5.0 V ± 0.5 V		
			Min	Max	Min	Max	Min	Max	Min	Max	Min	Max	
V_{CC(A)} = 1.5 V ± 0.1 V													
t _{pd}	propagation delay	An to YBn	1.7	20.7	1.6	17.1	1.3	12.9	1.1	11.1	1.0	9.5	ns
		B4 to YA4	1.7	20.7	1.6	19.8	1.6	19.0	1.5	18.5	1.5	18.3	ns
t _{dis}	disable time	\overline{OE} to YA4	1.3	11.6	1.3	11.6	1.3	11.6	1.3	11.6	1.3	11.6	ns
		\overline{OE} to YBn	1.5	14.4	1.6	13.2	1.3	10.4	1.5	10.7	1.2	9.4	ns
t _{en}	enable time	\overline{OE} to YA4	2.1	21.8	2.1	21.8	2.1	21.8	2.1	21.8	2.1	21.8	ns
		\overline{OE} to YBn	2.1	22.2	1.8	18.4	1.5	14.2	1.3	12.5	1.2	11.4	ns
V_{CC(A)} = 1.8 V ± 0.15 V													
t _{pd}	propagation delay	An to YBn	1.6	19.8	1.4	16.2	1.2	11.9	1.0	10.2	0.9	8.5	ns
		B4 to YA4	1.6	17.1	1.4	16.2	1.3	15.3	1.2	14.9	1.2	14.5	ns
t _{dis}	disable time	\overline{OE} to YA4	1.4	10.1	1.4	10.1	1.4	10.1	1.4	10.1	1.4	10.1	ns
		\overline{OE} to YBn	1.4	13.7	1.5	12.3	1.2	9.5	1.4	9.7	1.1	8.2	ns
t _{en}	enable time	\overline{OE} to YA4	1.8	17.2	1.8	17.2	1.8	17.2	1.8	17.2	1.8	17.2	ns
		\overline{OE} to YBn	2.0	21.4	1.7	17.4	1.4	12.9	1.2	11.1	1.1	9.8	ns
V_{CC(A)} = 2.5 V ± 0.2 V													
t _{pd}	propagation delay	An to YBn	1.6	19.0	1.3	15.3	1.0	11.0	0.9	9.1	0.7	7.2	ns
		B4 to YA4	1.3	12.9	1.2	11.9	1.0	11.0	0.9	10.6	0.9	10.2	ns
t _{dis}	disable time	\overline{OE} to YA4	0.9	7.2	0.9	7.2	0.9	7.2	0.9	7.2	0.9	7.2	ns
		\overline{OE} to YBn	1.3	12.8	1.4	11.3	1.1	8.4	1.3	8.5	1.0	6.9	ns
t _{en}	enable time	\overline{OE} to YA4	1.4	11.7	1.4	11.7	1.4	11.7	1.4	11.7	1.4	11.7	ns
		\overline{OE} to YBn	2.0	20.8	1.6	16.6	1.3	11.9	1.2	9.9	1.0	8.2	ns
V_{CC(A)} = 3.3 V ± 0.3 V													
t _{pd}	propagation delay	An to YBn	1.5	18.5	1.2	14.9	0.9	10.6	0.8	8.5	0.7	6.6	ns
		B4 to YA4	1.1	11.1	1.0	10.2	0.9	9.1	0.8	8.5	0.7	8.1	ns
t _{dis}	disable time	\overline{OE} to YA4	1.1	7.2	1.1	7.2	1.1	7.2	1.1	7.2	1.1	7.2	ns
		\overline{OE} to YBn	1.2	12.3	1.3	10.9	1.0	8.0	1.2	8.0	0.9	6.3	ns
t _{en}	enable time	\overline{OE} to YA4	1.2	9.3	1.2	9.3	1.2	9.3	1.2	9.3	1.2	9.3	ns
		\overline{OE} to YBn	2.0	20.4	1.7	16.5	1.4	11.5	1.2	9.4	1.0	7.5	ns
V_{CC(A)} = 5.0 V ± 0.5 V													
t _{pd}	propagation delay	An to YBn	1.5	18.3	1.2	14.5	0.9	10.2	0.7	8.1	0.6	6.3	ns
		B4 to YA4	1.0	9.5	0.9	8.5	0.7	7.2	0.7	6.6	0.6	6.3	ns
t _{dis}	disable time	\overline{OE} to YA4	0.7	5.3	0.7	5.3	0.7	5.3	0.7	5.3	0.7	5.3	ns
		\overline{OE} to YBn	1.2	12.0	1.3	10.5	0.9	7.6	1.2	7.6	0.8	5.8	ns
t _{en}	enable time	\overline{OE} to YA4	1.1	7.0	1.1	7.0	1.1	7.0	1.1	7.0	1.1	7.0	ns
		\overline{OE} to YBn	2.0	20.5	1.7	16.4	1.4	11.4	1.2	9.2	1.0	7.2	ns

[1] t_{pd} is the same as t_{PLH} and t_{PHL}; t_{dis} is the same as t_{PLZ} and t_{PHZ}; t_{en} is the same as t_{PZL} and t_{PZH}.

Table 12. Dynamic characteristics for temperature range -40 °C to +125 °C [1]

Voltages are referenced to GND (ground = 0 V); for test circuit see Fig. 4; for waveforms see Fig. 2 and Fig. 3.

Symbol	Parameter	Conditions	V _{CC(B)}										Unit
			1.5 V ± 0.1 V		1.8 V ± 0.15 V		2.5 V ± 0.2 V		3.3 V ± 0.3 V		5.0 V ± 0.5 V		
			Min	Max	Min	Max	Min	Max	Min	Max	Min	Max	
V_{CC(A)} = 1.5 V ± 0.1 V													
t _{pd}	propagation delay	An to YBn	1.7	22.0	1.6	18.3	1.3	14.0	1.1	12.2	1.0	10.5	ns
		B4 to YA4	1.7	22.0	1.6	21.0	1.6	20.1	1.5	19.5	1.5	19.4	ns
t _{dis}	disable time	\overline{OE} to YA4	1.3	12.8	1.3	12.8	1.3	12.8	1.3	12.8	1.3	12.8	ns
		\overline{OE} to YBn	1.5	15.8	1.6	14.5	1.3	11.5	1.5	11.1	1.2	9.7	ns
t _{en}	enable time	\overline{OE} to YA4	2.1	23.2	2.1	23.2	2.1	23.2	2.1	23.2	2.1	23.2	ns
		\overline{OE} to YBn	2.1	23.6	1.8	19.6	1.5	15.4	1.3	13.7	1.2	12.6	ns
V_{CC(A)} = 1.8 V ± 0.15 V													
t _{pd}	propagation delay	An to YBn	1.6	21.0	1.4	17.4	1.2	13.0	1.0	11.2	0.9	9.3	ns
		B4 to YA4	1.6	18.3	1.4	17.4	1.3	16.4	1.2	16.0	1.2	15.6	ns
t _{dis}	disable time	\overline{OE} to YA4	1.4	11.2	1.4	11.2	1.4	11.2	1.4	11.2	1.4	11.2	ns
		\overline{OE} to YBn	1.4	15.2	1.5	13.5	1.2	10.5	1.4	10.0	1.1	8.5	ns
t _{en}	enable time	\overline{OE} to YA4	1.8	18.4	1.8	18.4	1.8	18.4	1.8	18.4	1.8	18.4	ns
		\overline{OE} to YBn	2.0	22.7	1.7	18.7	1.4	14.1	1.2	12.2	1.1	10.8	ns
V_{CC(A)} = 2.5 V ± 0.2 V													
t _{pd}	propagation delay	An to YBn	1.6	20.1	1.3	16.4	1.0	11.9	0.9	9.9	0.7	7.9	ns
		B4 to YA4	1.3	14.0	1.2	13.0	1.0	11.9	0.9	11.5	0.9	11.1	ns
t _{dis}	disable time	\overline{OE} to YA4	0.9	8.0	0.9	8.0	0.9	8.0	0.9	8.0	0.9	8.0	ns
		\overline{OE} to YBn	1.3	14.0	1.4	12.5	1.1	9.3	1.3	9.3	1.0	7.5	ns
t _{en}	enable time	\overline{OE} to YA4	1.4	12.7	1.4	12.7	1.4	12.7	1.4	12.7	1.4	12.7	ns
		\overline{OE} to YBn	2.0	22.0	1.6	17.9	1.3	13.0	1.2	10.8	1.0	9.0	ns
V_{CC(A)} = 3.3 V ± 0.3 V													
t _{pd}	propagation delay	An to YBn	1.5	19.5	1.2	16.0	0.9	11.5	0.8	9.3	0.7	7.3	ns
		B4 to YA4	1.1	12.2	1.0	11.2	0.9	9.9	0.8	9.3	0.7	8.8	ns
t _{dis}	disable time	\overline{OE} to YA4	1.1	7.8	1.1	7.8	1.1	7.8	1.1	7.8	1.1	7.8	ns
		\overline{OE} to YBn	1.2	13.6	1.3	12.1	1.0	8.8	1.2	8.3	0.9	6.5	ns
t _{en}	enable time	\overline{OE} to YA4	1.2	10.1	1.2	10.1	1.2	10.1	1.2	10.1	1.2	10.1	ns
		\overline{OE} to YBn	2.0	21.6	1.7	17.5	1.4	12.6	1.2	10.3	1.0	8.3	ns
V_{CC(A)} = 5.0 V ± 0.5 V													
t _{pd}	propagation delay	An to YBn	1.5	19.4	1.2	15.6	0.9	11.1	0.7	8.8	0.6	6.8	ns
		B4 to YA4	1.0	10.5	0.9	9.3	0.7	7.9	0.7	7.3	0.6	6.8	ns
t _{dis}	disable time	\overline{OE} to YA4	0.7	5.7	0.7	5.7	0.7	5.7	0.7	5.7	0.7	5.7	ns
		\overline{OE} to YBn	1.2	13.3	1.3	11.7	0.9	8.4	1.2	7.9	0.8	6.0	ns
t _{en}	enable time	\overline{OE} to YA4	1.1	7.7	1.1	7.7	1.1	7.7	1.1	7.7	1.1	7.7	ns
		\overline{OE} to YBn	2.0	21.7	1.7	17.4	1.4	12.5	1.2	10.1	1.0	7.9	ns

[1] t_{pd} is the same as t_{PLH} and t_{PHL}; t_{dis} is the same as t_{PLZ} and t_{PHZ}; t_{en} is the same as t_{PZL} and t_{PZH}.

10.1. Waveforms and test circuit

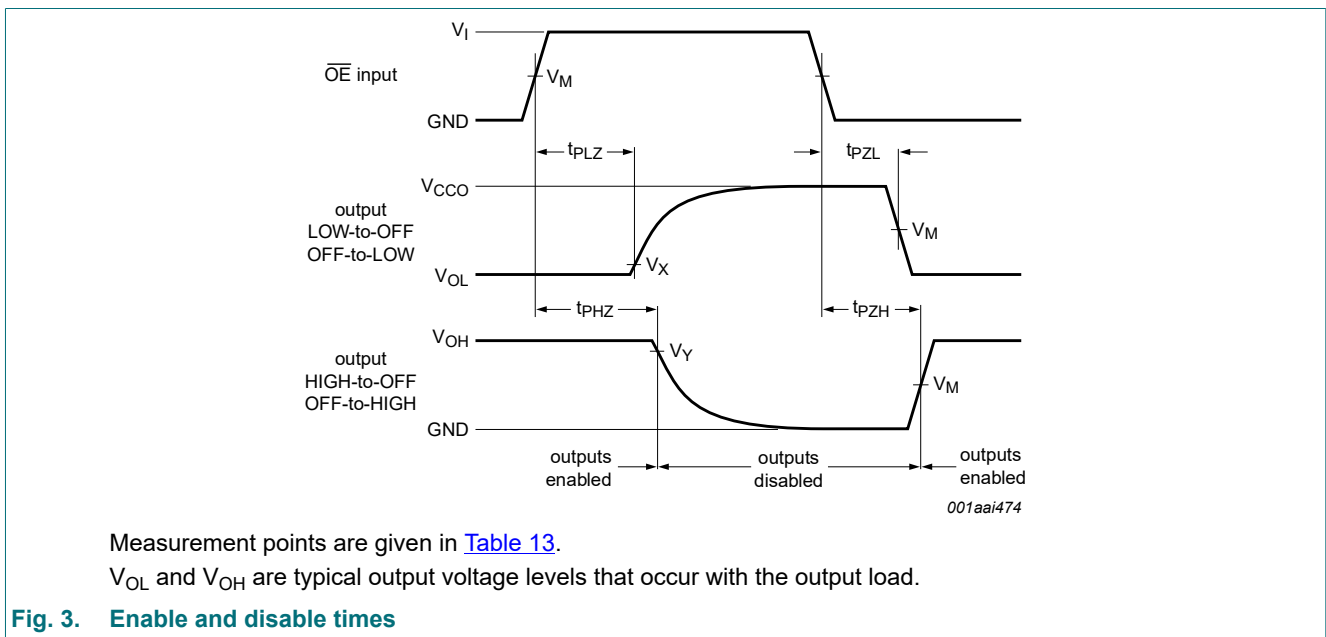
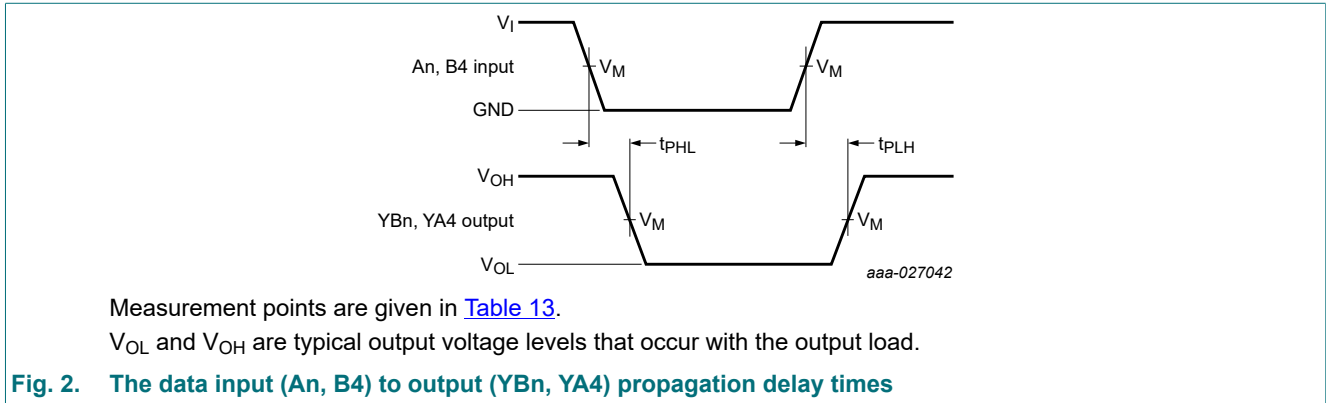

Table 13. Measurement points

Supply voltage	Input [1]	Output [2]		
$V_{CC(A)}, V_{CC(B)}$	V_M	V_M	V_X	V_Y
1.2 V to 1.6 V	$0.5 \times V_{CCI}$	$0.5 \times V_{CCO}$	$V_{OL} + 0.1 \text{ V}$	$V_{OH} - 0.1 \text{ V}$
1.65 V to 2.7 V	$0.5 \times V_{CCI}$	$0.5 \times V_{CCO}$	$V_{OL} + 0.15 \text{ V}$	$V_{OH} - 0.15 \text{ V}$
3.0 V to 5.5 V	$0.5 \times V_{CCI}$	$0.5 \times V_{CCO}$	$V_{OL} + 0.3 \text{ V}$	$V_{OH} - 0.3 \text{ V}$

[1] V_{CCI} is the supply voltage associated with the input port.
 [2] V_{CCO} is the supply voltage associated with the output port.

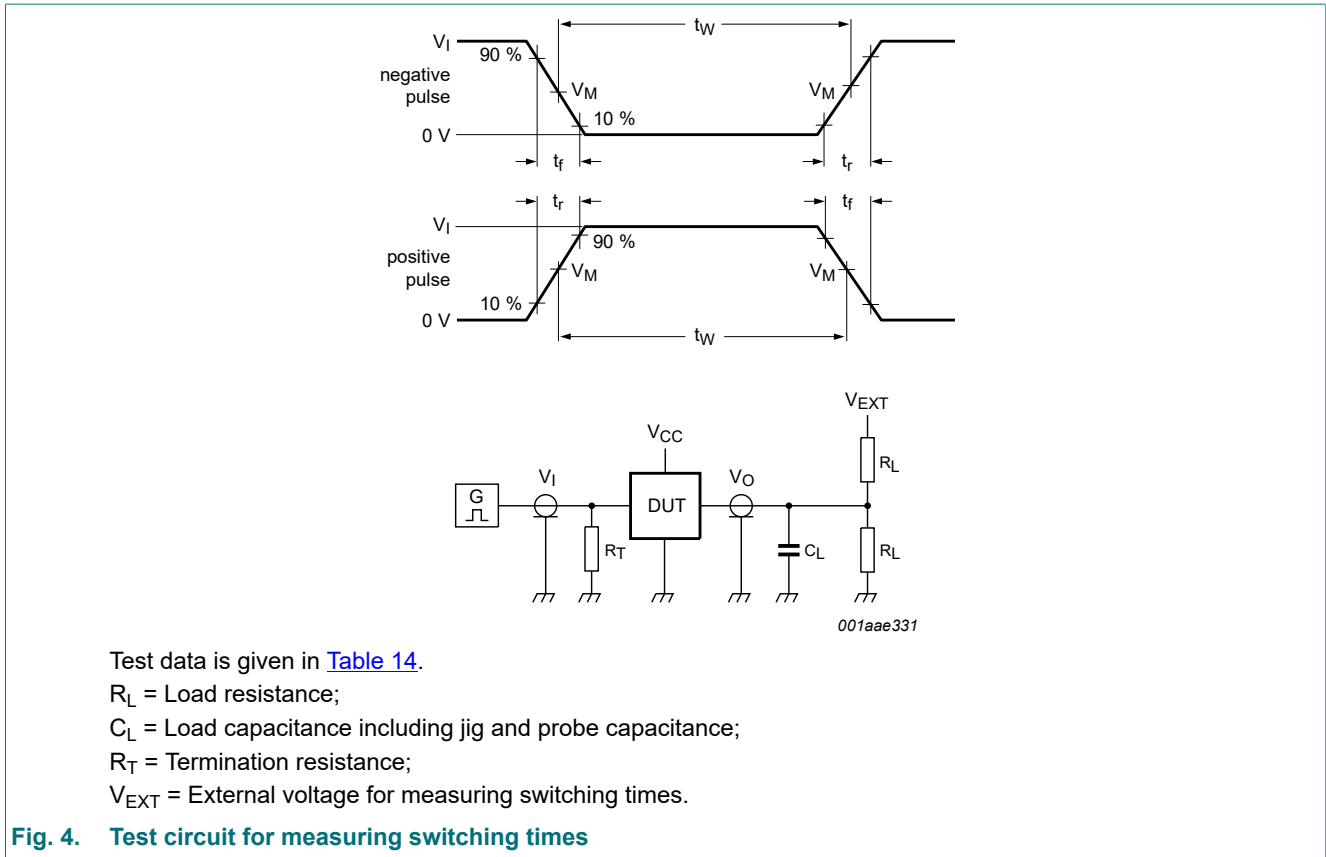
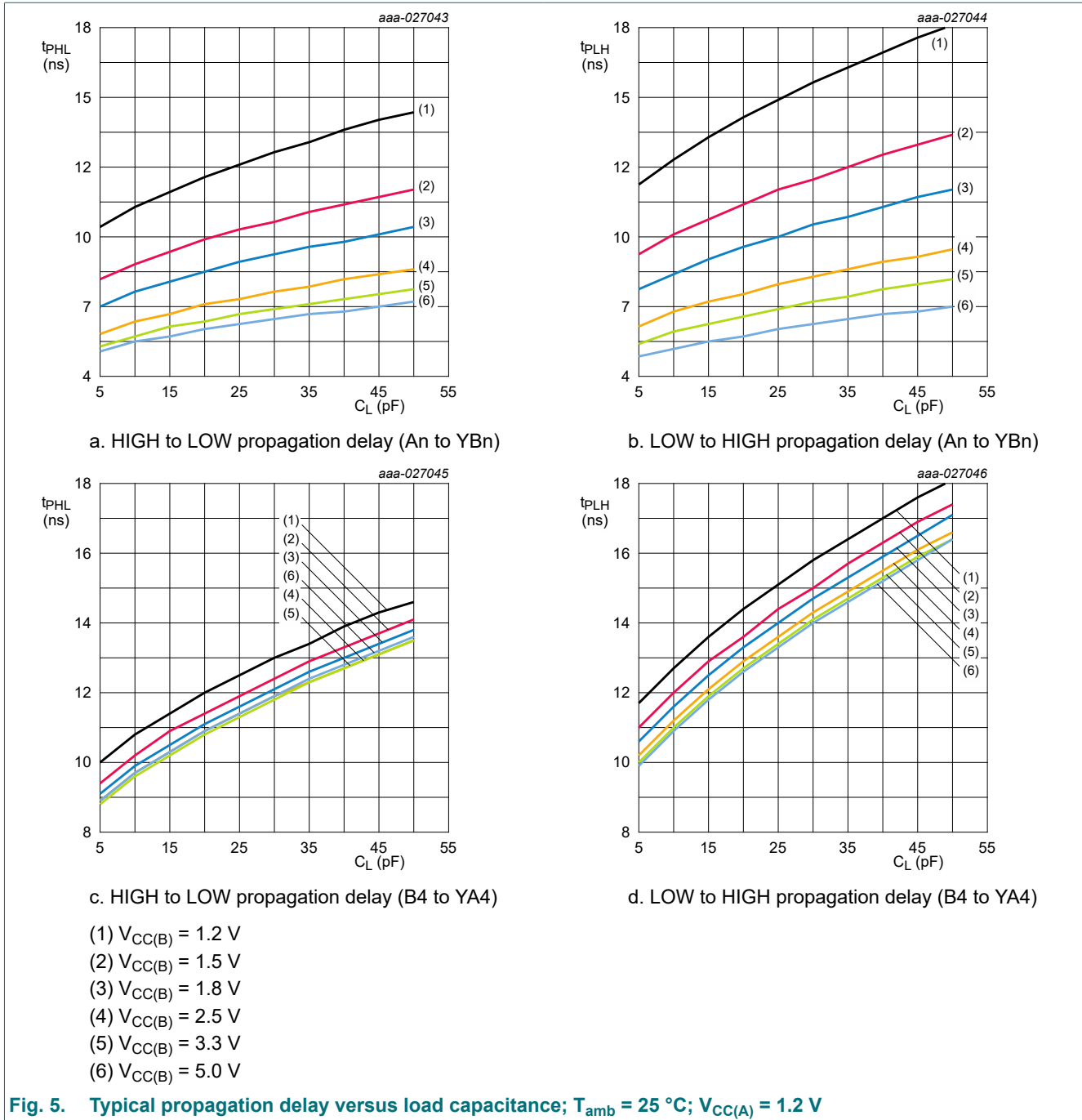

Table 14. Test data

Supply voltage	Input		Load		V_{EXT}		
$V_{CC(A)}, V_{CC(B)}$	V_I [1]	$\Delta t/\Delta V$ [2]	C_L	R_L	t_{PLH}, t_{PHL}	t_{PZH}, t_{PHZ}	t_{PZL}, t_{PLZ} [3]
1.2 V to 5.5 V	V_{CCI}	≤ 1.0 ns/V	15 pF	2 k Ω	open	GND	$2 \times V_{CCO}$

- [1] V_{CCI} is the supply voltage associated with the input port.
- [2] $dV/dt \geq 1.0$ V/ns.
- [3] V_{CCO} is the supply voltage associated with the output port.

10.2. Typical propagation delay characteristics



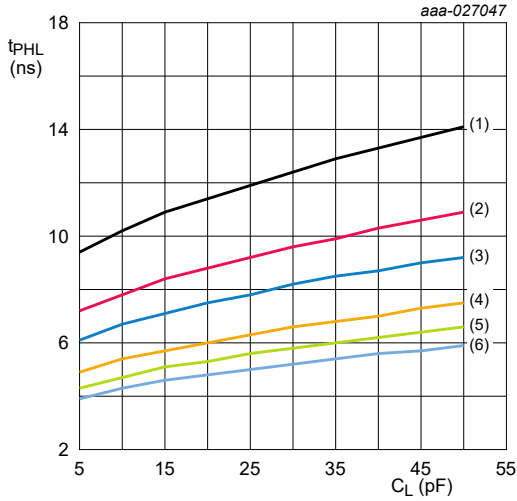

a. HIGH to LOW propagation delay (An to YBn)

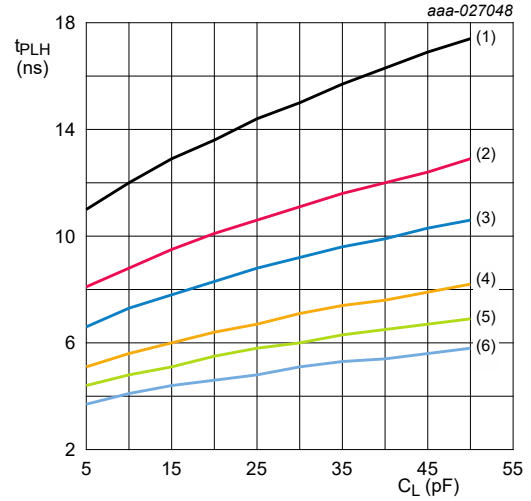

b. LOW to HIGH propagation delay (An to YBn)

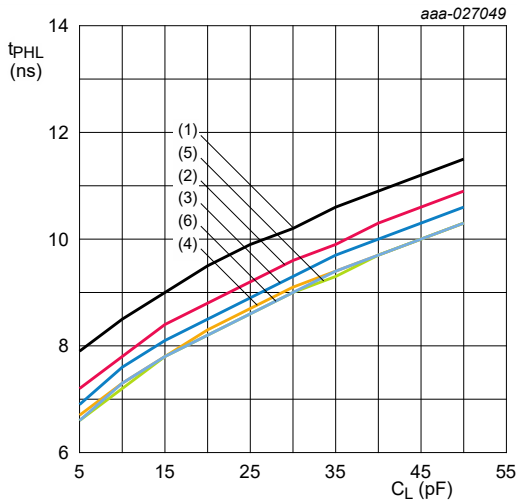

c. HIGH to LOW propagation delay (B4 to YA4)

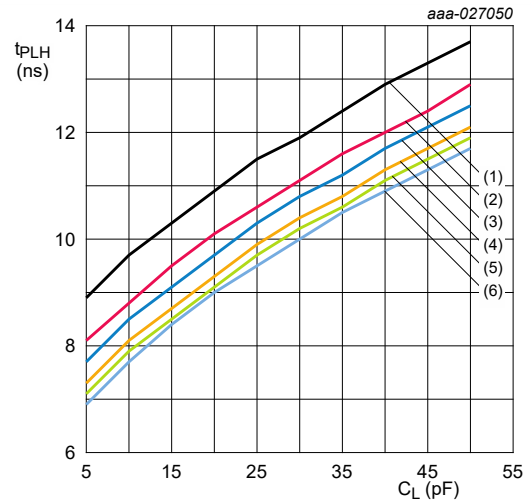

d. LOW to HIGH propagation delay (B4 to YA4)

- (1) $V_{CC(B)} = 1.2$ V
- (2) $V_{CC(B)} = 1.5$ V
- (3) $V_{CC(B)} = 1.8$ V
- (4) $V_{CC(B)} = 2.5$ V
- (5) $V_{CC(B)} = 3.3$ V
- (6) $V_{CC(B)} = 5.0$ V

Fig. 6. Typical propagation delay versus load capacitance; $T_{amb} = 25$ °C; $V_{CC(A)} = 1.5$ V

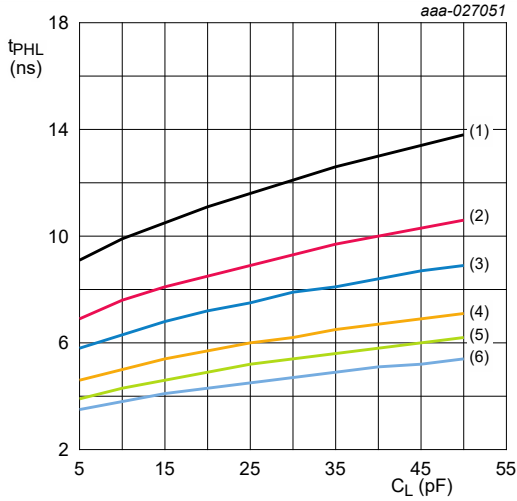

a. HIGH to LOW propagation delay (An to YBn)

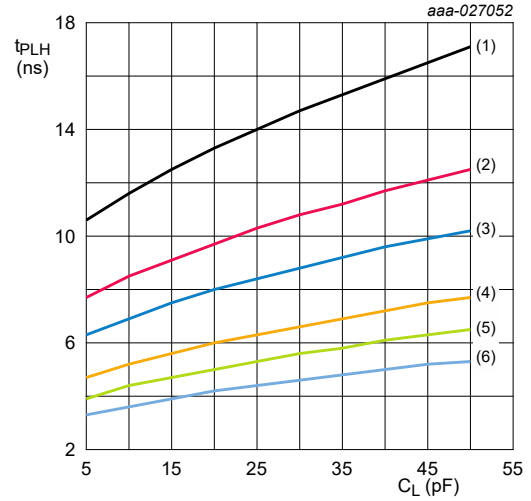

b. LOW to HIGH propagation delay (An to YBn)

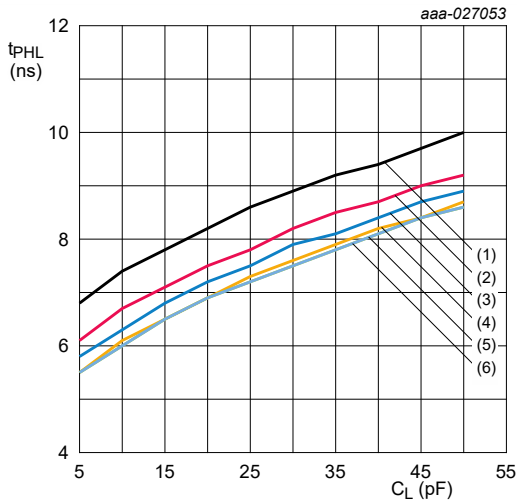

c. HIGH to LOW propagation delay (B4 to YA4)

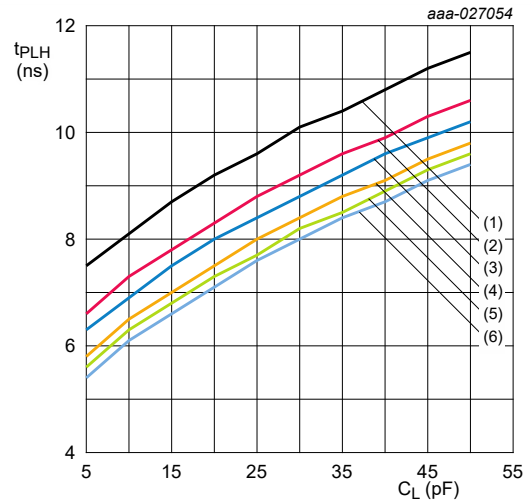

d. LOW to HIGH propagation delay (B4 to YA4)

- (1) $V_{CC(B)} = 1.2\text{ V}$
- (2) $V_{CC(B)} = 1.5\text{ V}$
- (3) $V_{CC(B)} = 1.8\text{ V}$
- (4) $V_{CC(B)} = 2.5\text{ V}$
- (5) $V_{CC(B)} = 3.3\text{ V}$
- (6) $V_{CC(B)} = 5.0\text{ V}$

Fig. 7. Typical propagation delay versus load capacitance; $T_{amb} = 25\text{ }^\circ\text{C}$; $V_{CC(A)} = 1.8\text{ V}$

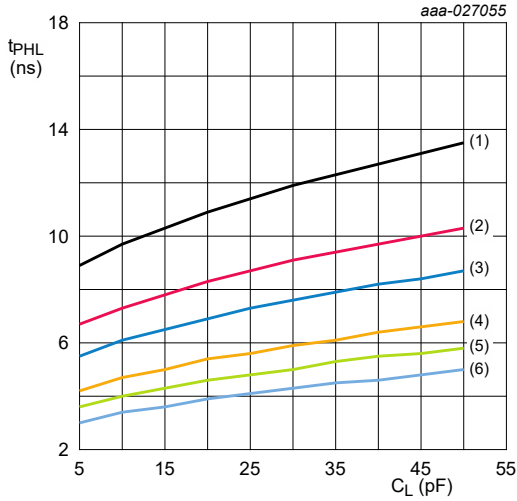

a. HIGH to LOW propagation delay (An to YBn)

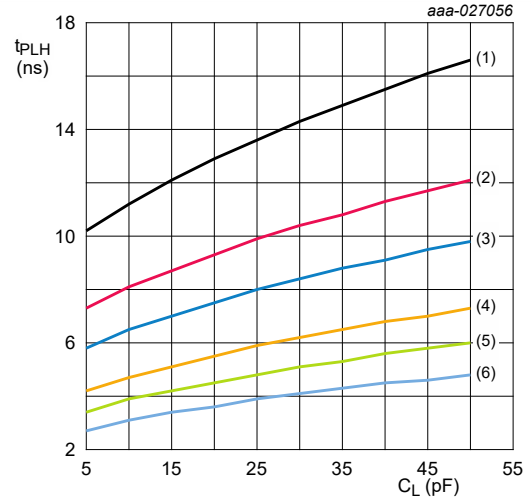

b. LOW to HIGH propagation delay (An to YBn)

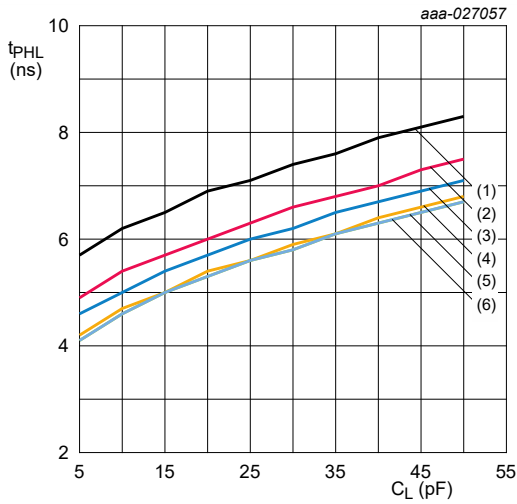

c. HIGH to LOW propagation delay (B4 to YA4)

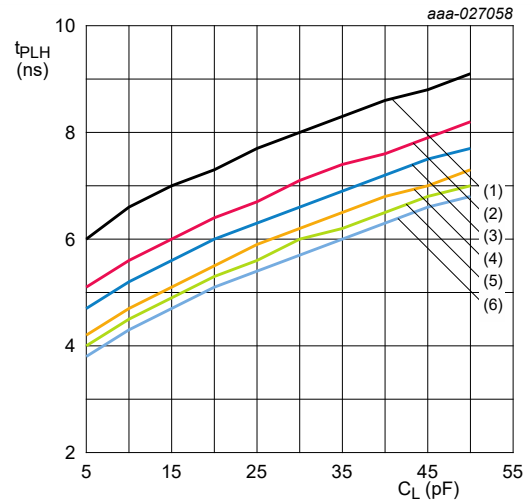

d. LOW to HIGH propagation delay (B4 to YA4)

- (1) $V_{CC(B)} = 1.2\text{ V}$
- (2) $V_{CC(B)} = 1.5\text{ V}$
- (3) $V_{CC(B)} = 1.8\text{ V}$
- (4) $V_{CC(B)} = 2.5\text{ V}$
- (5) $V_{CC(B)} = 3.3\text{ V}$
- (6) $V_{CC(B)} = 5.0\text{ V}$

Fig. 8. Typical propagation delay versus load capacitance; $T_{amb} = 25\text{ }^\circ\text{C}$; $V_{CC(A)} = 2.5\text{ V}$

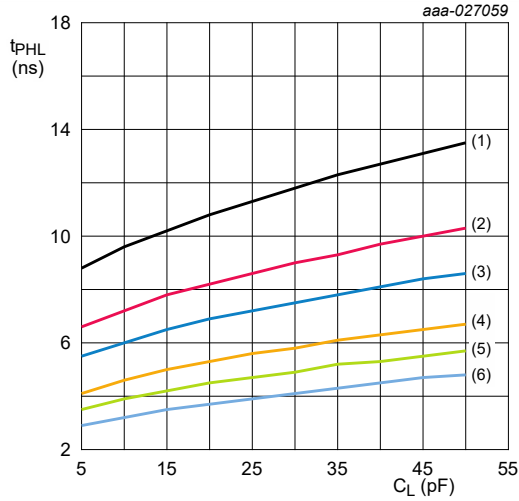

a. HIGH to LOW propagation delay (An to YBn)

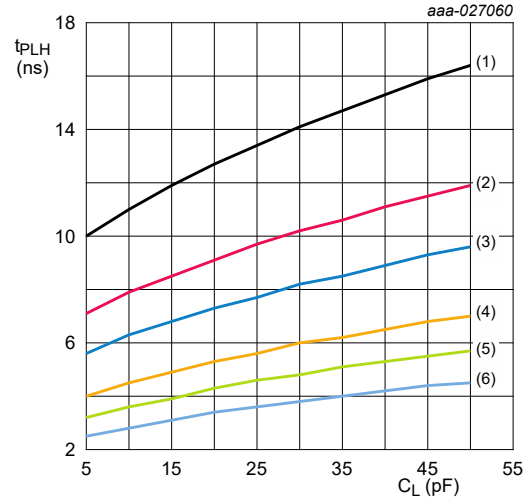

b. LOW to HIGH propagation delay (An to YBn)

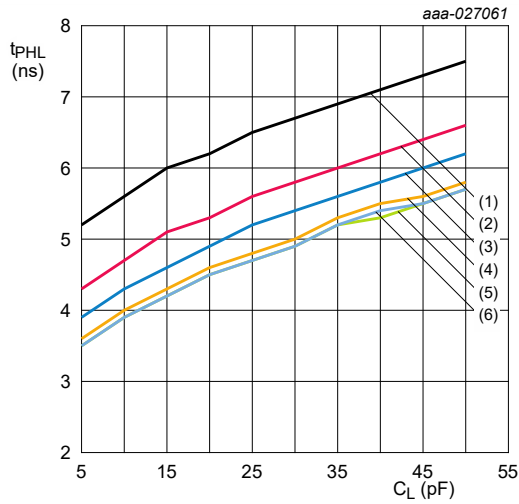

c. HIGH to LOW propagation delay (B4 to YA4)

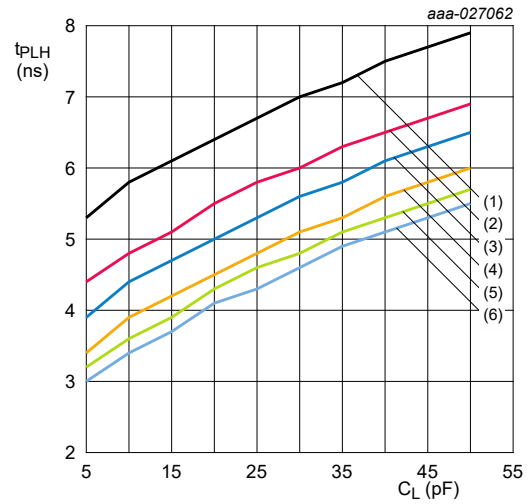

d. LOW to HIGH propagation delay (B4 to YA4)

- (1) $V_{CC(B)} = 1.2\text{ V}$
- (2) $V_{CC(B)} = 1.5\text{ V}$
- (3) $V_{CC(B)} = 1.8\text{ V}$
- (4) $V_{CC(B)} = 2.5\text{ V}$
- (5) $V_{CC(B)} = 3.3\text{ V}$
- (6) $V_{CC(B)} = 5.0\text{ V}$

Fig. 9. Typical propagation delay versus load capacitance; $T_{amb} = 25\text{ }^\circ\text{C}$; $V_{CC(A)} = 3.3\text{ V}$

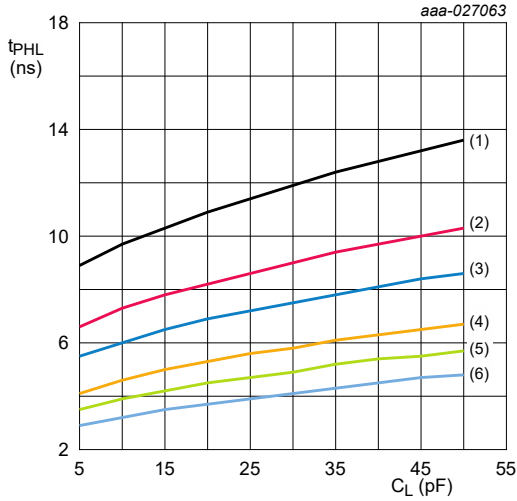

a. HIGH to LOW propagation delay (An to YBn)

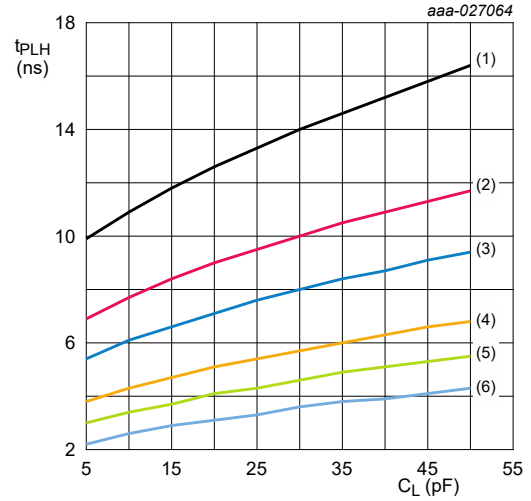

b. LOW to HIGH propagation delay (An to YBn)

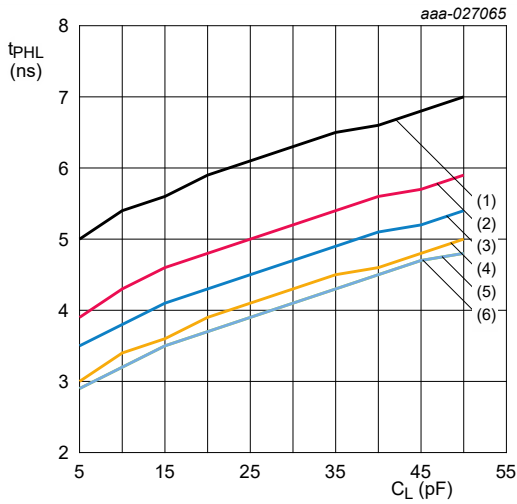

c. HIGH to LOW propagation delay (B4 to YA4)

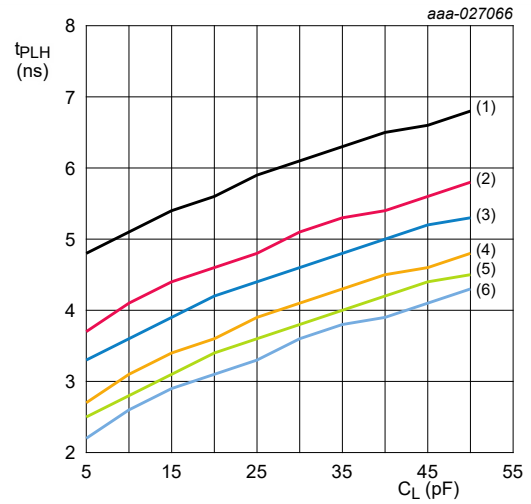

d. LOW to HIGH propagation delay (B4 to YA4)

- (1) $V_{CC(B)} = 1.2\text{ V}$
- (2) $V_{CC(B)} = 1.5\text{ V}$
- (3) $V_{CC(B)} = 1.8\text{ V}$
- (4) $V_{CC(B)} = 2.5\text{ V}$
- (5) $V_{CC(B)} = 3.3\text{ V}$
- (6) $V_{CC(B)} = 5.0\text{ V}$

Fig. 10. Typical propagation delay versus load capacitance; $T_{amb} = 25\text{ }^\circ\text{C}$; $V_{CC(A)} = 5\text{ V}$

11. Application information

11.1. Unidirectional logic level-shifting application

The circuit given in Fig. 11 is an example of the 74LVC4T3144 being used in an unidirectional logic level-shifting application.

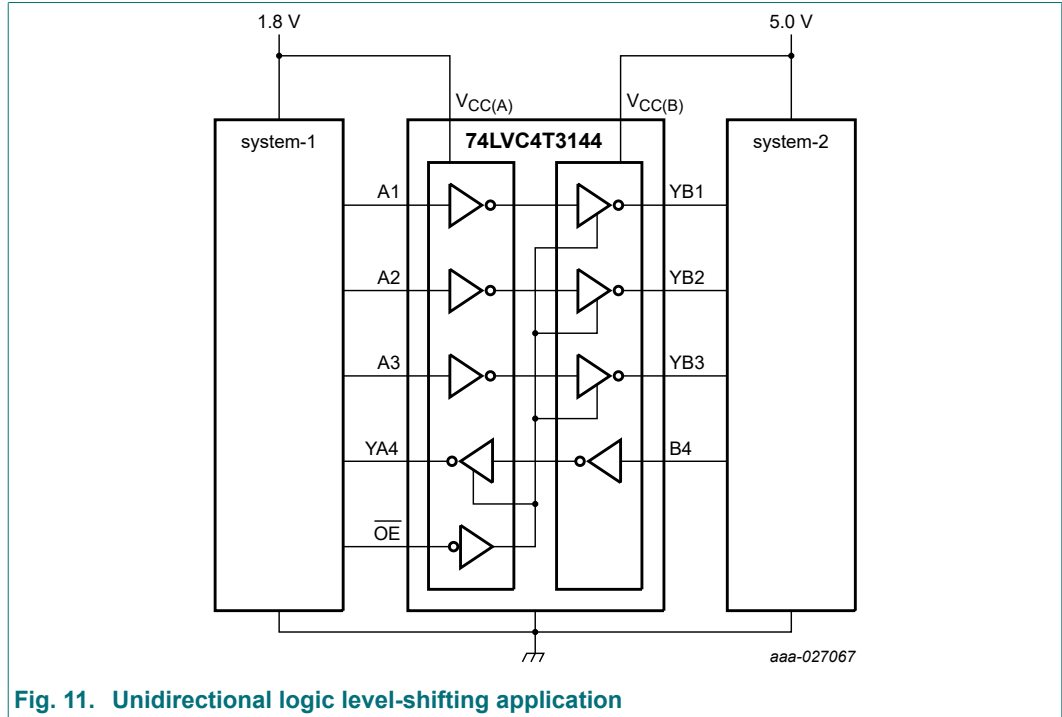

Fig. 11. Unidirectional logic level-shifting application

Table 15. Description unidirectional logic level-shifting application

Name	Description
$V_{CC(A)}$	supply voltage of system-1 (1.2 V to 5.5 V)
$V_{CC(B)}$	supply voltage of system-2 (1.2 V to 5.5 V)
A1, A2, A3	input level depends on $V_{CC(A)}$ voltage
YA4	output level depends on $V_{CC(A)}$ voltage
YB1, YB2, YB3	output level depends on $V_{CC(B)}$ voltage
B4	input level depends on $V_{CC(B)}$ voltage
\overline{OE}	input level depends on $V_{CC(A)}$ voltage
GND	device GND

11.2. Power-up considerations

The device is designed such that no special power-up sequence is required other than GND being applied first.

Table 16. Typical total supply current ($I_{CC(A)} + I_{CC(B)}$)

$V_{CC(A)}$	$V_{CC(B)}$							Unit
	0 V	1.2 V	1.5 V	1.8 V	2.5 V	3.3 V	5.0 V	
0 V	0	< 1	< 1	< 1	< 1	< 1	< 1	μA
1.2 V	< 1	< 1	< 1	< 1	< 1	< 1	1	μA
1.5 V	< 1	< 1	< 1	< 1	< 1	< 1	< 1	μA
1.8 V	< 1	< 1	< 1	< 1	< 1	< 1	< 1	μA
2.5 V	< 1	< 1	< 1	< 1	< 1	< 1	< 1	μA
3.3 V	< 1	< 1	< 1	< 1	< 1	< 1	< 1	μA
5.0 V	< 1	1	< 1	< 1	< 1	< 1	< 1	μA

12. Package outline

TSSOP14: plastic thin shrink small outline package; 14 leads; body width 4.4 mm

SOT402-1

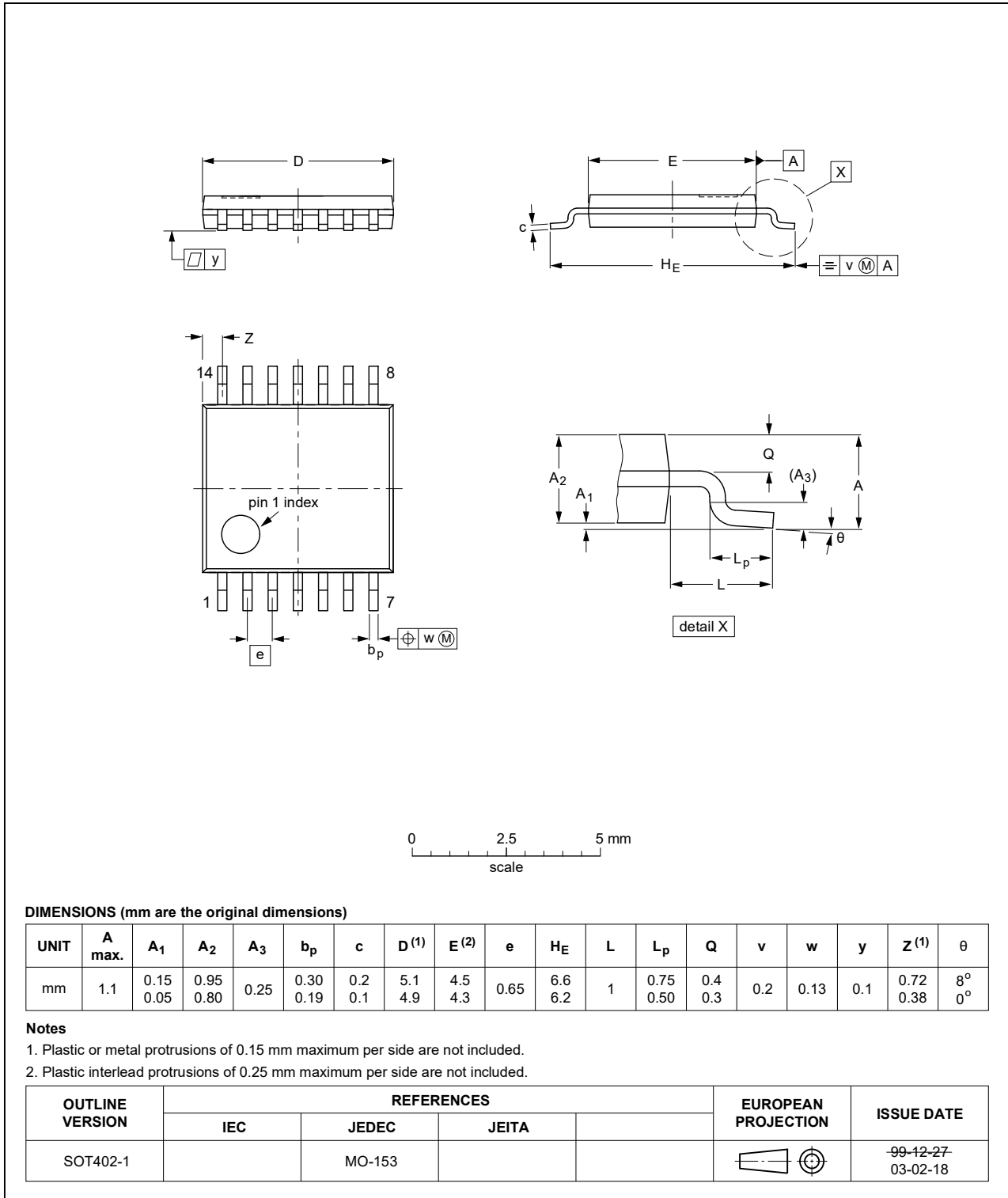

Fig. 12. Package outline SOT402-1 (TSSOP14)

13. Abbreviations

Table 17. Abbreviations

Acronym	Description
CDM	Charged Device Model
DUT	Device Under Test
ESD	ElectroStatic Discharge
HBM	Human Body Model

14. Revision history

Table 18. Revision history

Document ID	Release date	Data sheet status	Change notice	Supersedes
74LVC4T3144 v.2	20230803	Product data sheet	-	74LVC4T3144 v.1
Modifications:	<ul style="list-style-type: none">• Section 2: ESD specification updated according to the latest JEDEC standard.• Section 7: Derating values for P_{tot} total power dissipation updated.			
74LVC4T3144 v.1	20170814	Product data sheet	-	-

15. Legal information

Data sheet status

Document status [1][2]	Product status [3]	Definition
Objective [short] data sheet	Development	This document contains data from the objective specification for product development.
Preliminary [short] data sheet	Qualification	This document contains data from the preliminary specification.
Product [short] data sheet	Production	This document contains the product specification.

- [1] Please consult the most recently issued document before initiating or completing a design.
- [2] The term 'short data sheet' is explained in section "Definitions".
- [3] The product status of device(s) described in this document may have changed since this document was published and may differ in case of multiple devices. The latest product status information is available on the internet at <https://www.nexperia.com>.

Definitions

Draft — The document is a draft version only. The content is still under internal review and subject to formal approval, which may result in modifications or additions. Nexperia does not give any representations or warranties as to the accuracy or completeness of information included herein and shall have no liability for the consequences of use of such information.

Short data sheet — A short data sheet is an extract from a full data sheet with the same product type number(s) and title. A short data sheet is intended for quick reference only and should not be relied upon to contain detailed and full information. For detailed and full information see the relevant full data sheet, which is available on request via the local Nexperia sales office. In case of any inconsistency or conflict with the short data sheet, the full data sheet shall prevail.

Product specification — The information and data provided in a Product data sheet shall define the specification of the product as agreed between Nexperia and its customer, unless Nexperia and customer have explicitly agreed otherwise in writing. In no event however, shall an agreement be valid in which the Nexperia product is deemed to offer functions and qualities beyond those described in the Product data sheet.

Disclaimers

Limited warranty and liability — Information in this document is believed to be accurate and reliable. However, Nexperia does not give any representations or warranties, expressed or implied, as to the accuracy or completeness of such information and shall have no liability for the consequences of use of such information. Nexperia takes no responsibility for the content in this document if provided by an information source outside of Nexperia.

In no event shall Nexperia be liable for any indirect, incidental, punitive, special or consequential damages (including - without limitation - lost profits, lost savings, business interruption, costs related to the removal or replacement of any products or rework charges) whether or not such damages are based on tort (including negligence), warranty, breach of contract or any other legal theory.

Notwithstanding any damages that customer might incur for any reason whatsoever, Nexperia's aggregate and cumulative liability towards customer for the products described herein shall be limited in accordance with the Terms and conditions of commercial sale of Nexperia.

Right to make changes — Nexperia reserves the right to make changes to information published in this document, including without limitation specifications and product descriptions, at any time and without notice. This document supersedes and replaces all information supplied prior to the publication hereof.

Suitability for use — Nexperia products are not designed, authorized or warranted to be suitable for use in life support, life-critical or safety-critical systems or equipment, nor in applications where failure or malfunction of an Nexperia product can reasonably be expected to result in personal

injury, death or severe property or environmental damage. Nexperia and its suppliers accept no liability for inclusion and/or use of Nexperia products in such equipment or applications and therefore such inclusion and/or use is at the customer's own risk.

Quick reference data — The Quick reference data is an extract of the product data given in the Limiting values and Characteristics sections of this document, and as such is not complete, exhaustive or legally binding.

Applications — Applications that are described herein for any of these products are for illustrative purposes only. Nexperia makes no representation or warranty that such applications will be suitable for the specified use without further testing or modification.

Customers are responsible for the design and operation of their applications and products using Nexperia products, and Nexperia accepts no liability for any assistance with applications or customer product design. It is customer's sole responsibility to determine whether the Nexperia product is suitable and fit for the customer's applications and products planned, as well as for the planned application and use of customer's third party customer(s). Customers should provide appropriate design and operating safeguards to minimize the risks associated with their applications and products.

Nexperia does not accept any liability related to any default, damage, costs or problem which is based on any weakness or default in the customer's applications or products, or the application or use by customer's third party customer(s). Customer is responsible for doing all necessary testing for the customer's applications and products using Nexperia products in order to avoid a default of the applications and the products or of the application or use by customer's third party customer(s). Nexperia does not accept any liability in this respect.

Limiting values — Stress above one or more limiting values (as defined in the Absolute Maximum Ratings System of IEC 60134) will cause permanent damage to the device. Limiting values are stress ratings only and (proper) operation of the device at these or any other conditions above those given in the Recommended operating conditions section (if present) or the Characteristics sections of this document is not warranted. Constant or repeated exposure to limiting values will permanently and irreversibly affect the quality and reliability of the device.

Terms and conditions of commercial sale — Nexperia products are sold subject to the general terms and conditions of commercial sale, as published at <http://www.nexperia.com/profile/terms>, unless otherwise agreed in a valid written individual agreement. In case an individual agreement is concluded only the terms and conditions of the respective agreement shall apply. Nexperia hereby expressly objects to applying the customer's general terms and conditions with regard to the purchase of Nexperia products by customer.

No offer to sell or license — Nothing in this document may be interpreted or construed as an offer to sell products that is open for acceptance or the grant, conveyance or implication of any license under any copyrights, patents or other industrial or intellectual property rights.

Export control — This document as well as the item(s) described herein may be subject to export control regulations. Export might require a prior authorization from competent authorities.

Non-automotive qualified products — Unless this data sheet expressly states that this specific Nexperia product is automotive qualified, the product is not suitable for automotive use. It is neither qualified nor tested in accordance with automotive testing or application requirements. Nexperia accepts no liability for inclusion and/or use of non-automotive qualified products in automotive equipment or applications.

In the event that customer uses the product for design-in and use in automotive applications to automotive specifications and standards, customer (a) shall use the product without Nexperia's warranty of the product for such automotive applications, use and specifications, and (b) whenever customer uses the product for automotive applications beyond Nexperia's specifications such use shall be solely at customer's own risk, and (c) customer fully indemnifies Nexperia for any liability, damages or failed product claims resulting from customer design and use of the product for automotive applications beyond Nexperia's standard warranty and Nexperia's product specifications.

Translations — A non-English (translated) version of a document is for reference only. The English version shall prevail in case of any discrepancy between the translated and English versions.

Trademarks

Notice: All referenced brands, product names, service names and trademarks are the property of their respective owners.

Contents

1. General description	1
2. Features and benefits	1
3. Ordering information	2
4. Functional diagram	2
5. Pinning information	2
5.1. Pinning.....	2
5.2. Pin description.....	3
6. Functional description	3
7. Limiting values	4
8. Recommended operating conditions	4
9. Static characteristics	5
10. Dynamic characteristics	8
10.1. Waveforms and test circuit.....	11
10.2. Typical propagation delay characteristics.....	13
11. Application information	19
11.1. Unidirectional logic level-shifting application.....	19
11.2. Power-up considerations.....	20
12. Package outline	21
13. Abbreviations	22
14. Revision history	22
15. Legal information	23

© Nexperia B.V. 2023. All rights reserved

For more information, please visit: <http://www.nexperia.com>
For sales office addresses, please send an email to: salesaddresses@nexperia.com
Date of release: 3 August 2023