

NOTES:

1. ROHS COMPLIANT
2. HEADER: THERMOSET PLASTIC MATERIAL WITH FLAMMABILITY RATING UL 94V-0 OR BETTER.
3. STORAGE TEMPERATURE: -20°C TO +125°C
4. COMPLIANCE TO J-STD:
 - A. J-STD-002: SOLDERABILITY AT 245°C REFLOW PROFILE
 - B. J-STD-020: LEVEL 1, NO MOISTURE SENSITIVE
 - C. J-STD-075: R7, 245°C MAXIMUM THROUGH REFLOW SOLDER
5. TO ORDER TAPE & REEL PACKAGING ADD A "T" SUFFIX TO THE PART NUMBER(i.e H7018NL BECOMES H7018NLT).

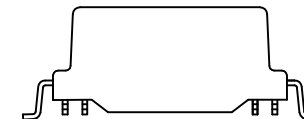
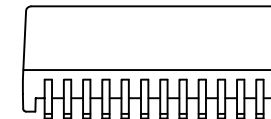
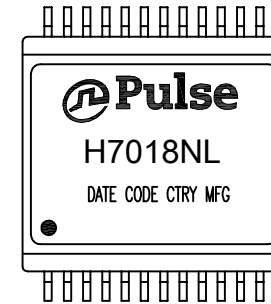

FINAL OUTLINE

© Copyright, 2015. Pulse Electronics Corp. All rights reserved. Pulse confidential & proprietary. (07/30/15)

PRODUCT DESCRIPTION	TLA DRAWING	PS DRAWING	SHEET	PART NO.	DATASHEET REV.
MDL,SIN,10G,1:1,SM,TU	H7018NL-15	PS-2517.001-A	1 OF 3	H7018NL	A

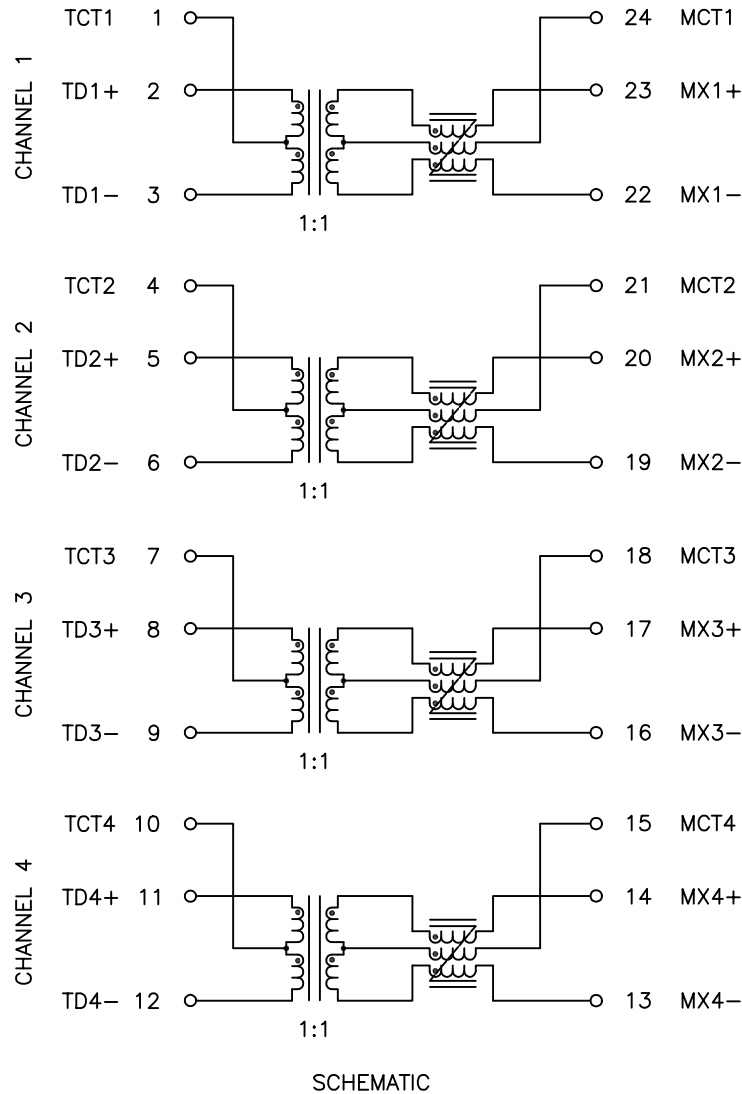

ELECTRICAL CHARACTERISTICS AT +25°C UNLESS OTHER SPECIFIED
MEETS IEEE 802.3 SPECIFICATION

PARAMETER	SPECIFICATIONS		
OPERATING TEMP	0°C – 70°C		
URNS RATIO	1.00 ± 2%		
POLARITY	PER SCHEMATIC		
INSERTION LOSS	100 KHz	1–500 MHz	
	-3.0 dB MAX	-1.0 dB MAX (-.6 dB TYP)	
RETURN LOSS (Z OUT = 100 OHM ± 1%)	1–40 MHz	40 MHz–500 MHz	
	-18 dB MIN	-17 + 10*LOG (f/40)	
INDUCTANCE (OCL)	120 uH TYP @ 100 kHz, 100 mV		
CROSSTALK, ADJACENT CHANNELS	1–100 MHz	100–500 MHz	
	-40 dB MIN	-30 dB MIN	
COMMON MODE REJECTION RATIO	1–100 MHz	100–300 MHz	300–500 MHz
	-35 dB MIN	-30 dB MIN	-25 dB MIN
	COMMON TO DIFFERENTIAL MODE REJECTION (CDMR)		
	1–250 MHz	250–500 MHz	
	-30 dB MIN	-22 dB MIN	
INPUT – OUTPUT ISOLATION	1500 VRMS MIN @ 60 SECONDS		

NOTE: f IS FREQUENCY IN MHZ.

© Copyright, 2015. Pulse Electronics Corp. All rights reserved. Pulse confidential & proprietary. (07/30/15)

PRODUCT DESCRIPTION	TLA DRAWING	PS DRAWING	SHEET	PART NO.	DATASHEET REV.
MDL,SIN,10G,1:1,SM,TU	H7018NL-15	PS-2517.001-A	2 OF 3	H7018NL	A

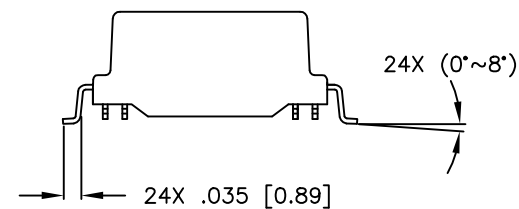
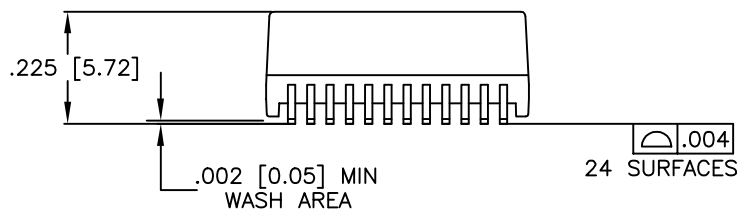
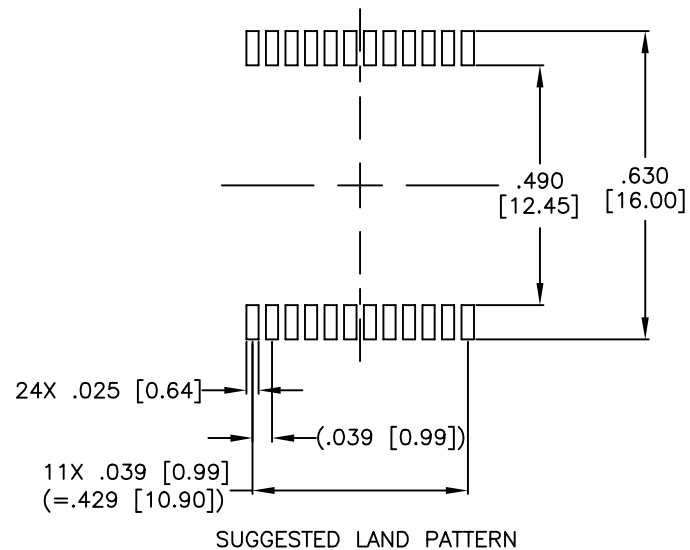
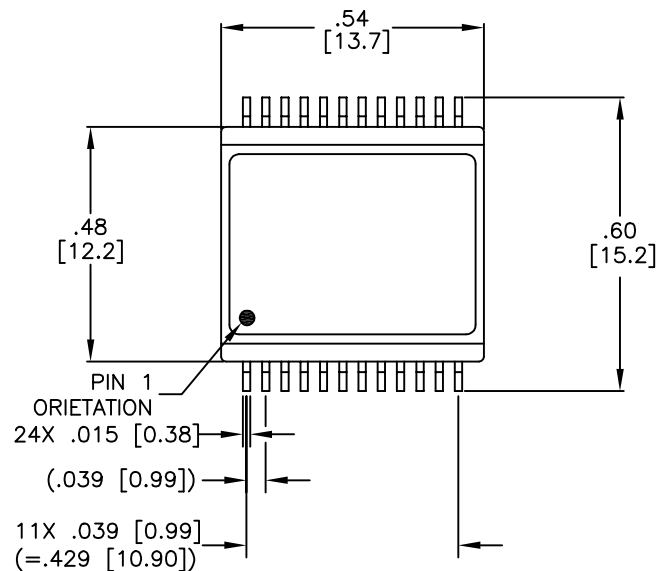

DIMENSIONS ARE IN INCHES [MILLIMETERS] WITH THE FOLLOWING TOLERANCES: [MILLIMETERS] ARE FOR REFERENCE ONLY.
.XX= ±.02 [±0.50]
.XXX= ±.010 [±0.25]

© Copyright, 2015. Pulse Electronics Corp. All rights reserved. Pulse confidential & proprietary. (07/30/15)

PRODUCT DESCRIPTION	TLA DRAWING	PS DRAWING	SHEET	PART NO.	DATASHEET REV.
MDL,SIN,10G,1:1,SM,TU	H7018NL-15	PS-2517.001-A	3 OF 3	H7018NL	A