

PRODUCT GUIDE

Photocouplers and Photorelays

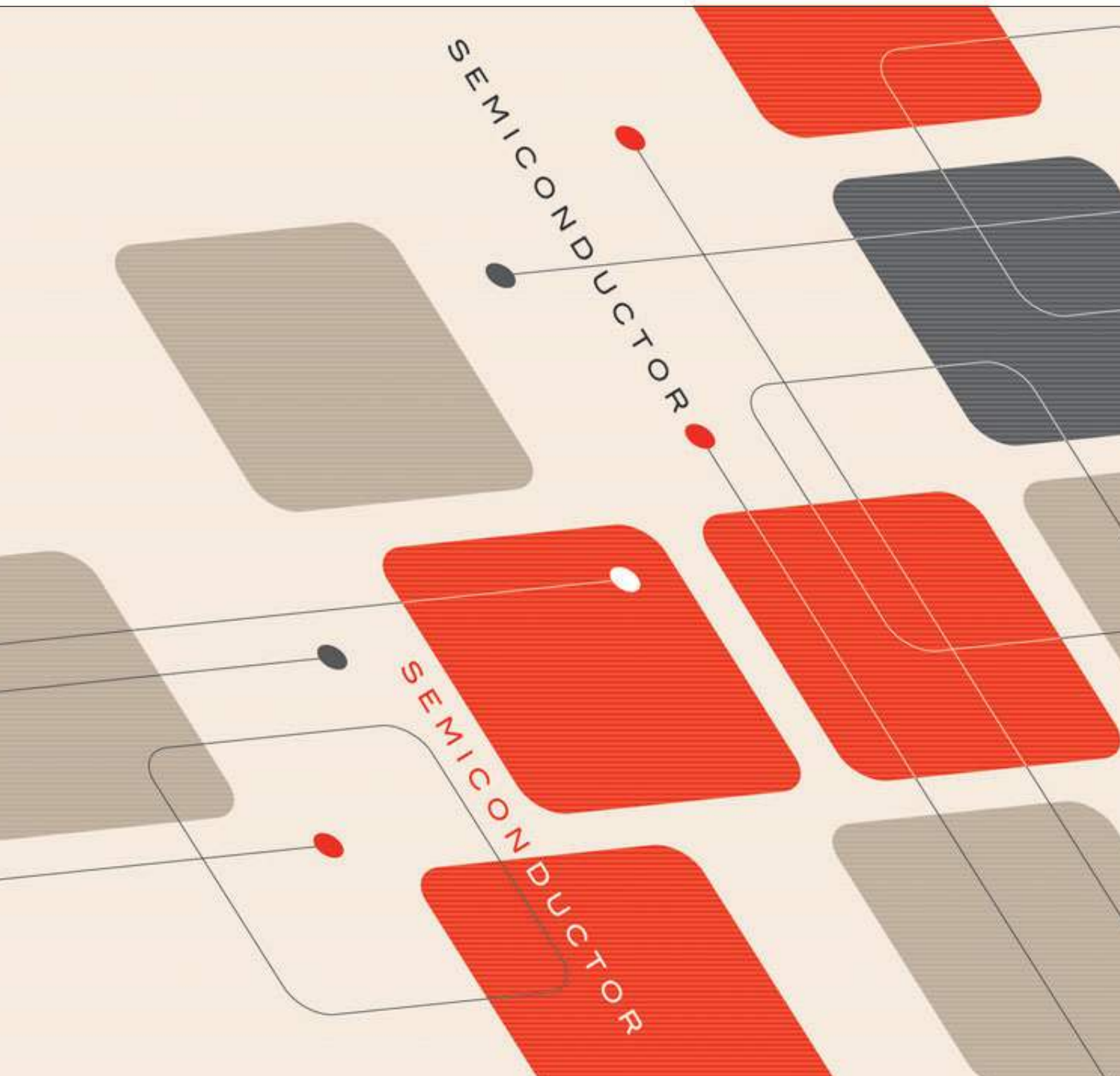

• SEMICONDUCTOR •

<http://www.semicon.toshiba.co.jp/eng>

Preface

As a type of isolator favored by manufacturers, photocouplers now serve as noise protectors in many electronic devices. Toshiba's photocouplers consist of either a GaAs or GaAlAs infrared LED(s) and a silicon photodetector(s) housed in a mold package. GaAlAs LEDs are adopted in high-speed photo-IC types due to their high-speed and high-light output.

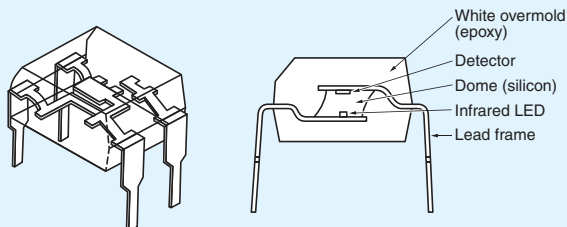

Perspective view of the TLP521-1

Cross section of the TLP521-1

Extensive Line of Products

To meet customers' various needs, we offer an extensive product portfolio shown below as well as general-purpose photocouplers.

1. Photo-IC couplers: High speed and advanced functions (highly integrated detectors)
2. Zero-crossing phototriac couplers: Phototriac-output devices with zero-crossing detection
3. Photovoltaic couplers: MOSFET gate drive (high voltage output achieved using a photodiode array)
4. Photorelays (MOSFET-output devices):
AC-DC switches (MOSFET output)
Mechanical relay replacement

Safety Standard Approvals

UL approval has been obtained under file number E67349 for most of our photocouplers. EN60747-5-2-approved photocouplers are also offered with a wide selection of output (transistor, thyristor, triac, IC output and photorelay). The designs of these devices meet other standards including IEC380/VDE0806, IEC60950/EN60950 and IEC60065/EN60065.

Small-Package Products

Toshiba offers a wide variety of photocouplers in a small package to meet the space-saving requirement of increasingly smaller and thinner end products. Packaging options include mini-flat packages (MFSOPs) and half-pitch (1.27 mm) mini-flat SOP packages.

Overseas Manufactured Photocouplers

Part of the general-purpose photocouplers with transistor and triac outputs are manufactured by Toshiba Semiconductor Thailand Co., Ltd. This will help customers procure components locally for overseas assembly of end products.

CONTENTS

1. Product Index	3	6. Package Information	42
2. New Products	5	1. Lead Form Options for DIP Packages	42
3. Photocoupler Product Tree	9	2. Package Dimensions	43
4. Selection Guide	10	3. Rank Marking	49
1. Transistor-Output and Darlington-Transistor-Output Photocouplers	10	7. Packing Information	50
2. Photocouplers for Logic Signal Transmission	17	1. Photocoupler Magazine Packing Specifications	51
3. Photocouplers for IGBT/MOSFET Gate Drive	23	2. Tape-and-Reel Specifications	53
4. Photorelays (1-Form-A and 2-Form-A)	26	8. Board Assembly	56
5. Photorelays (1-Form-B, 2-Form-B and 1-Form-A/1-Form-B)	32	1. Example Land Patterns	56
6. Triac-Output Photocouplers	34	2. Board Assembly Considerations	57
7. Thyristor-Output Photocouplers	37	9. Device Degradation	58
8. Photovoltaic-Output photocouplers	38	1. Projected Operating Life Based on LED Light Output Degradation	58
9. Products Manufactured by Toshiba Semiconductor (Thailand) Co., Ltd. (TST)	38	10. Safety Standard Approvals	65
5. Part Naming Conventions	41	11. Photocoupler Application Circuit Examples	67
		12. Competitor Cross Reference	79

1 Product Index

Part Number	Package	Output	Page
TLP104	SO6	IC	22
TLP105	MFSOP6	IC	20
TLP108	MFSOP6	IC	18
TLP109	SO6	IC	21
TLP109 (IGM)	SO6	IC	22
TLP116A	SO6	IC	18
TLP117	MFSOP6	IC	17
TLP118	SO6	IC	18
TLP124	MFSOP6	Transistor	11
TLP126	MFSOP6	Transistor	14
TLP127	MFSOP6	Darlington transistor	16
TLP130	MFSOP6	Transistor	14
TLP131	MFSOP6	Transistor	11
TLP137	MFSOP6	Transistor	11
TLP148G	MFSOP6	Thyristor	37
TLP151	SO6	IC	24
TLP151A	SO6	IC	24
TLP155E	SO6	IC	24
TLP160G	MFSOP6	Triac	34
TLP160J	MFSOP6	Triac	34
TLP161G	MFSOP6	Triac	34
TLP161J	MFSOP6	Triac	34
TLP163J	MFSOP6	Triac	34
TLP165J	MFSOP6	Triac	34
TLP166J	MFSOP6	Triac	34
TLP168J	MFSOP6	Triac	34
TLP170A	2.54SOP4	MOSFET (Photorelay)	28
TLP170D	2.54SOP4	MOSFET (Photorelay)	28
TLP170G	2.54SOP4	MOSFET (Photorelay)	28
TLP170J	2.54SOP4	MOSFET (Photorelay)	28
TLP172A	2.54SOP4	MOSFET (Photorelay)	28
TLP172G	2.54SOP4	MOSFET (Photorelay)	28
TLP173A	MFSOP6	MOSFET (Photorelay)	28
TLP174G	2.54SOP4	MOSFET (Photorelay)	28
TLP174GA	2.54SOP4	MOSFET (Photorelay)	28
TLP175A	SO6	MOSFET (Photorelay)	27
TLP176A	2.54SOP4	MOSFET (Photorelay)	28
TLP176D	2.54SOP4	MOSFET (Photorelay)	28
TLP176G	2.54SOP4	MOSFET (Photorelay)	28
TLP176GA	2.54SOP4	MOSFET (Photorelay)	28
TLP179D	2.54SOP4	MOSFET (Photorelay)	28
TLP180	MFSOP6	Transistor	14,38
TLP181	MFSOP6	Transistor	11,38
TLP184	SO6	Transistor	39
TLP185	SO6	Transistor	39
TLP190B	MFSOP6	Photovoltaic	36
TLP191B	MFSOP6	Photovoltaic	36
TLP192A	2.54SOP6	MOSFET (Photorelay)	29
TLP192G	2.54SOP6	MOSFET (Photorelay)	29
TLP197A	2.54SOP6	MOSFET (Photorelay)	29
TLP197D	2.54SOP6	MOSFET (Photorelay)	29
TLP197G	2.54SOP6	MOSFET (Photorelay)	29
TLP197GA	2.54SOP6	MOSFET (Photorelay)	29
TLP199D	2.54SOP6	MOSFET (Photorelay)	29
TLP200D	2.54SOP8	MOSFET (Photorelay)	30
TLP202A	2.54SOP8	MOSFET (Photorelay)	30
TLP202G	2.54SOP8	MOSFET (Photorelay)	30
TLP2066	MFSOP6	IC	18
TLP206A	2.54SOP8	MOSFET (Photorelay)	30
TLP206G	2.54SOP8	MOSFET (Photorelay)	30
TLP206GA	2.54SOP8	MOSFET (Photorelay)	30
TLP2095	MFSOP6	IC	20
TLP2098	MFSOP6	IC	20
TLP209D	2.54SOP8	MOSFET (Photorelay)	30
TLP2105	SO8	IC	21
TLP2108	SO8	IC	21
TLP2116	SO8	IC	18
TLP2118E	SO8	IC	18
TLP2160	SO8	IC	19
TLP2166A	SO8	IC	19
TLP2167	SO8	IC	17
TLP2168	SO8	IC	19
TLP2200	DIP8	IC	21
TLP220A	DIP4	MOSFET (Photorelay)	30
TLP220D	DIP4	MOSFET (Photorelay)	30
TLP220G	DIP4	MOSFET (Photorelay)	30
TLP220GA	DIP4	MOSFET (Photorelay)	30
TLP220J	DIP4	MOSFET (Photorelay)	30
TLP221A	DIP4	MOSFET (Photorelay)	30

Part Number	Package	Output	Page
TLP222A	DIP4	MOSFET (Photorelay)	30
TLP222A-2	DIP8	MOSFET (Photorelay)	31
TLP222G	DIP4	MOSFET (Photorelay)	31
TLP222G-2	DIP8	MOSFET (Photorelay)	31
TLP224G	DIP4	MOSFET (Photorelay)	30
TLP224G-2	DIP8	MOSFET (Photorelay)	31
TLP224GA	DIP4	MOSFET (Photorelay)	30
TLP224GA-2	DIP8	MOSFET (Photorelay)	31
TLP225A	DIP4	MOSFET (Photorelay)	30
TLP227A	DIP4	MOSFET (Photorelay)	30
TLP227A-2	DIP8	MOSFET (Photorelay)	31
TLP227G	DIP4	MOSFET (Photorelay)	30
TLP227G-2	DIP8	MOSFET (Photorelay)	32
TLP227GA	DIP4	MOSFET (Photorelay)	30
TLP227GA-2	DIP8	MOSFET (Photorelay)	32
TLP2366	SO6	IC	19
TLP2367	SO6	IC	17
TLP2368	SO6	IC	19
TLP2403	SO8	IC	21
TLP2404	SO8	IC	22
TLP2405	SO8	IC	20
TLP2408	SO8	IC	20
TLP2409	SO8	IC	21
TLP2409 (IGM)	SO8	IC	22
TLP2418	SO8	IC	18
TLP2451	SO8	IC	24
TLP2451A	SO8	IC	24
TLP2466	SO8	IC	19
TLP2467	SO8	IC	18
TLP2468	SO8	IC	19
TLP2530	DIP8	IC	22
TLP2531	DIP8	IC	22
TLP2601	DIP8	IC	19
TLP260J	MFSOP6	Triac	35
TLP261J	MFSOP6	Triac	35
TLP2630	DIP8	IC	20
TLP2631	DIP8	IC	20
TLP2766	SDIP6	IC	19
TLP2767	SDIP6	IC	18
TLP2768	SDIP6	IC	19
TLP280	SOP4	Transistor	14,39
TLP280-4	SOP16	Transistor	14
TLP281	SOP4	Transistor	11,39
TLP281-4	SOP16	Transistor	12
TLP284	SOP4	Transistor	11,39
TLP284-4	SOP16	Transistor	11
TLP285	SOP4	Transistor	11,39
TLP285-4	SOP16	Transistor	11
TLP290-4	SO16	Transistor	39
TLP291-4	SO16	Transistor	39
TLP3022 (S)	DIP6	Triac	36,40
TLP3023 (S)	DIP6	Triac	36,40
TLP3042 (S)	DIP6	Triac	36,40
TLP3043 (S)	DIP6	Triac	36,40
TLP3052 (S)	DIP6	Triac	36,40
TLP3062 (S)	DIP6	Triac	37,40
TLP3063 (S)	DIP6	Triac	37,40
TLP3064 (S)	DIP6	Triac	37,40
TLP3082 (S)	DIP6	Triac	37,40
TLP3100	2.54SOP6	MOSFET (Photorelay)	29
TLP3110	2.54SOP4	MOSFET (Photorelay)	28
TLP3111	2.54SOP4	MOSFET (Photorelay)	28
TLP3113	2.54SOP4	MOSFET (Photorelay)	28
TLP3114	2.54SOP4	MOSFET (Photorelay)	28
TLP3115	2.54SOP4	MOSFET (Photorelay)	28
TLP3116	2.54SOP4	MOSFET (Photorelay)	28
TLP3118	2.54SOP6	MOSFET (Photorelay)	28
TLP3119	2.54SOP4	MOSFET (Photorelay)	28
TLP3120	2.54SOP6	MOSFET (Photorelay)	29
TLP3121	2.54SOP4	MOSFET (Photorelay)	29
TLP3122	2.54SOP4	MOSFET (Photorelay)	29
TLP3123	2.54SOP4	MOSFET (Photorelay)	29
TLP3125	2.54SOP8	MOSFET (Photorelay)	29
TLP3130	2.54SOP4	MOSFET (Photorelay)	29
TLP3131	2.54SOP4	MOSFET (Photorelay)	29
TLP320	DIP4	Transistor	15
TLP320-2	DIP8	Transistor	15
TLP3203	SSOP4	MOSFET (Photorelay)	27
TLP320-4	DIP16	Transistor	15

1 Product Index

Part Number	Package	Output	Page
TLP3212	SSOP4	MOSFET (Photorelay)	27
TLP3213	SSOP4	MOSFET (Photorelay)	27
TLP3214	SSOP4	MOSFET (Photorelay)	27
TLP3215	SSOP4	MOSFET (Photorelay)	27
TLP3216	SSOP4	MOSFET (Photorelay)	27
TLP3217	SSOP4	MOSFET (Photorelay)	27
TLP3218	SSOP4	MOSFET (Photorelay)	27
TLP3219	SSOP4	MOSFET (Photorelay)	27
TLP3220	SSOP4	MOSFET (Photorelay)	27
TLP3230	SSOP4	MOSFET (Photorelay)	27
TLP3231	SSOP4	MOSFET (Photorelay)	27
TLP3240	SSOP4	MOSFET (Photorelay)	27
TLP3241	SSOP4	MOSFET (Photorelay)	27
TLP3250	SSOP4	MOSFET (Photorelay)	27
TLP3275	SSOP4	MOSFET (Photorelay)	27
TLP330	DIP6	Transistor	15
TLP331	DIP6	Transistor	12
TLP3312	USOP4	MOSFET (Photorelay)	27
TLP332	DIP6	Transistor	12
TLP3375	USOP4	MOSFET (Photorelay)	27
TLP350	DIP8	IC	24
TLP350H	DIP8	IC	24
TLP351	DIP8	IC	24
TLP351A	DIP8	IC	24
TLP351H	DIP8	IC	24
TLP352	DIP8	IC	24
TLP3542	DIP6	MOSFET (Photorelay)	31
TLP3543	DIP6	MOSFET (Photorelay)	31
TLP3544	DIP6	MOSFET (Photorelay)	31
TLP3545	DIP6	MOSFET (Photorelay)	31
TLP3546	DIP6	MOSFET (Photorelay)	31
TLP360J	DIP4	Triac	35
TLP361J	DIP4	Triac	35
TLP363J	DIP4	Triac	35
TLP371	DIP6	Darlington transistor	16
TLP372	DIP6	Darlington transistor	16
TLP373	DIP6	Darlington transistor	16
TLP3762 (S)	DIP6	Triac	37
TLP3782 (S)	DIP6	Triac	37,40
TLP3783 (S)	DIP6	Triac	37,40
TLP3902	MFSOP6	Photovoltaic	38
TLP3904	SSOP4	Photovoltaic	38
TLP3914	SSOP4	Photovoltaic	38
TLP3924	SSOP4	Photovoltaic	38
TLP4006G	DIP8	MOSFET (Photorelay)	33
TLP4007G	DIP8	MOSFET (Photorelay)	33
TLP4026G	2.54SOP8	MOSFET (Photorelay)	33
TLP4027G	2.54SOP8	MOSFET (Photorelay)	33
TLP4172G	2.54SOP4	MOSFET (Photorelay)	32
TLP4176G	2.54SOP4	MOSFET (Photorelay)	32
TLP4192G	2.54SOP6	MOSFET (Photorelay)	32
TLP4197G	2.54SOP6	MOSFET (Photorelay)	32
TLP4202G	2.54SOP8	MOSFET (Photorelay)	33
TLP4206G	2.54SOP8	MOSFET (Photorelay)	32
TLP4222G	DIP4	MOSFET (Photorelay)	32
TLP4222G-2	DIP8	MOSFET (Photorelay)	33
TLP4227G	DIP4	MOSFET (Photorelay)	33
TLP4227G-2	DIP8	MOSFET (Photorelay)	33
TLP4592G	DIP6	MOSFET (Photorelay)	32
TLP4597G	DIP6	MOSFET (Photorelay)	33
TLP504A	DIP8	Transistor	12
TLP512	DIP6	IC	21
TLP513	DIP6	IC	19
TLP523	DIP4	Darlington transistor	16
TLP523-2	DIP8	Darlington transistor	16
TLP523-4	DIP16	Darlington transistor	16
TLP525G	DIP4	Triac	35
TLP525G-2	DIP8	Triac	35
TLP525G-4	DIP16	Triac	35
TLP531	DIP6	Transistor	12
TLP532	DIP6	Transistor	12
TLP548J	DIP6	Thyristor	37
TLP549J	DIP8	Thyristor	37
TLP550	DIP8	IC	21
TLP551	DIP8	IC	21
TLP552	DIP8	IC	19
TLP553	DIP8	IC	21
TLP554	DIP8	IC	19

Part Number	Package	Output	Page
TLP555	DIP8	IC	20
TLP557	DIP8	IC	25
TLP558	DIP8	IC	20
TLP559	DIP8	IC	21
TLP559 (IGM)	DIP8	IC	23
TLP560G	DIP6	Triac	35
TLP560J	DIP6	Triac	36
TLP561G	DIP6	Triac	36
TLP561J	DIP6	Triac	36
TLP570	DIP6	Darlington transistor	16
TLP571	DIP6	Darlington transistor	16
TLP572	DIP6	Darlington transistor	16
TLP590B	DIP6	Photovoltaic	38
TLP591B	DIP6	Photovoltaic	38
TLP592A	DIP6	MOSFET (Photorelay)	31
TLP592G	DIP6	MOSFET (Photorelay)	31
TLP597A	DIP6	MOSFET (Photorelay)	31
TLP597G	DIP6	MOSFET (Photorelay)	31
TLP597GA	DIP6	MOSFET (Photorelay)	31
TLP598AA	DIP6	MOSFET (Photorelay)	31
TLP598GA	DIP6	MOSFET (Photorelay)	31
TLP620	DIP4	Transistor	15,39
TLP620-2	DIP8	Transistor	15,39
TLP620-4	DIP16	Transistor	15
TLP624	DIP4	Transistor	12
TLP624-2	DIP8	Transistor	12
TLP624-4	DIP16	Transistor	12
TLP626	DIP4	Transistor	15
TLP626-2	DIP8	Transistor	15
TLP626-4	DIP16	Transistor	15
TLP627	DIP4	Darlington transistor	16,39
TLP627-2	DIP8	Darlington transistor	16,39
TLP627-4	DIP16	Darlington transistor	16
TLP628	DIP4	Transistor	12
TLP628-2	DIP8	Transistor	13
TLP628-4	DIP16	Transistor	13
TLP629	DIP4	Transistor	13
TLP629-2	DIP8	Transistor	13
TLP629-4	DIP16	Transistor	13
TLP630	DIP6	Transistor	15
TLP631	DIP6	Transistor	13
TLP632	DIP6	Transistor	13
TLP651	DIP8	IC	21
TLP700	SDIP6	IC	25
TLP700H	SDIP6	IC	25
TLP701	SDIP6	IC	25
TLP701A	SDIP6	IC	25
TLP701H	SDIP6	IC	25
TLP705	SDIP6	IC	25
TLP705A	SDIP6	IC	25
TLP708	SDIP6	IC	18
TLP714	SDIP6	IC	22
TLP715	SDIP6	IC	20
TLP716	SDIP6	IC	18
TLP718	SDIP6	IC	20
TLP719	SDIP6	IC	21
TLP731	DIP6	Transistor	13
TLP732	DIP6	Transistor	13
TLP733	DIP6	Transistor	13
TLP734	DIP6	Transistor	14
TLP748J	DIP6	Thyristor	37
TLP750	DIP8	IC	22
TLP751	DIP8	IC	22
TLP754	DIP8	IC	22
TLP759	DIP8	IC	22
TLP759 (IGM)	DIP8	IC	23
TLP762J	DIP6	Triac	36
TLP763J	DIP6	Triac	36
TLP781	DIP4	Transistor	14
TLP785	DIP4	Transistor	14
TLP797GA	DIP6	MOSFET (Photorelay)	31
TLP797J	DIP6	MOSFET (Photorelay)	31
TLP798GA	DIP6	MOSFET (Photorelay)	31
6N135	DIP8	IC	23
6N136	DIP8	IC	23
6N137	DIP8	IC	23
6N138	DIP8	IC	23
6N139	DIP8	IC	23

2 New Products

Small Surface-Mount IC-Output Photocouplers in the SO8 Package

Toshiba is expanding its portfolio of IC-output photocouplers in the small and thin SO8 package. To meet customer needs, Toshiba has released photocouplers featuring various data rates, dual-channel configurations and power device drivers.

Data rate (typ.)	Part Number	# of Circuits	Output	Supply Voltage
0.1 Mbit/s	TLP2403	1-ch	Darlington	Up to 18 V
1 Mbit/s	TLP2404	1-ch	Open-collector	4.5 V to 30 V
	TLP2409	1-ch		Up to 30 V
5 Mbit/s	TLP2405	1-ch	Totem-pole	4.5 V to 20 V
	TLP2408	1-ch		
	TLP2105	2-ch		
15 Mbit/s to 20 Mbit/s	TLP2108	2-ch	Totem-pole	3.3 V/5 V
	TLP2466*	1-ch		
	TLP2160*	2-ch	Open-collector	5 V
	TLP2418	1-ch		
	TLP2118E	2-ch	Open-collector	3.3 V/5 V
	TLP2468*	1-ch		
	TLP2168*	2-ch	Totem-pole	5 V
	TLP2116	2-ch		
TLP2166A	2-ch	Totem-pole	3.3 V	
50 Mbit/s	TLP2467*			1-ch
	TLP2167*	2-ch		
Driver Propagation Delay: 0.7 μ s (max)	TLP2451	1-ch	± 0.6 -A peak current	10 V to 30 V
Driver Propagation Delay: 0.5 μ s (max)	TLP2451A*	1-ch	± 0.6 -A peak current	10 V to 30 V

*Under development. Specifications subject to change without notice. For the latest information, please contact your nearest Toshiba sales representative.

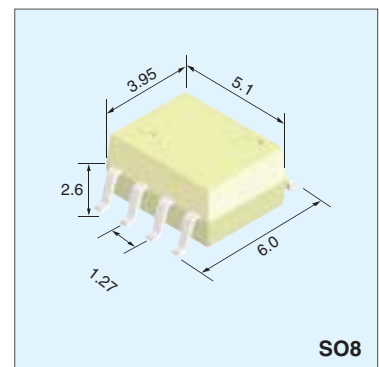
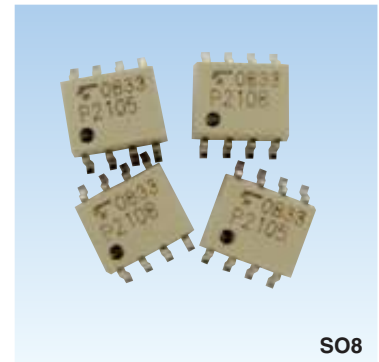

IGBT/MOSFET Gate-Drive IC-Output Photocouplers with an Extended Operating Temperature Range

Printed circuit boards are becoming smaller and denser as a result of product miniaturization. This is driving the need for electronic components with an extended operating temperature range.

To meet this need, Toshiba has been expanding its portfolio of IC-output photocouplers that are guaranteed up to 125°C instead of the conventional 100°C limit.

- Wide packaging options: SO6, SO8, SDIP6, DIP8
- Key specifications are guaranteed over -40°C to 125°C (-40°C to 110°C for the TLP151)
- Low current consumption: $I_{CC} = 2 \text{ mA}$ (max)

Peak Output Current	Part Number	Package	Supply Voltage (Vcc)	Supply Current (Icc)	Input Threshold Current	Propagation Delay (max)	UVLO
$\pm 0.6 \text{ A}$	TLP351H*	DIP8	10 V to 30 V	2 mA (max)	5 mA (max)	700 ns	-
	TLP701H*	SDIP6					-
	TLP2451	SO8					-
	TLP2451A*	SO8				500 ns	-
	TLP151*	SO6				700 ns	-
$\pm 2.0 \text{ A}$	TLP151A*	SO6	15 V to 30 V			500 ns	-
	TLP700H*	SDIP6					Yes
$\pm 2.5 \text{ A}$	TLP350H*	DIP8					Yes

*Under development. Specifications subject to change without notice. For the latest information, please contact your nearest Toshiba sales representative.

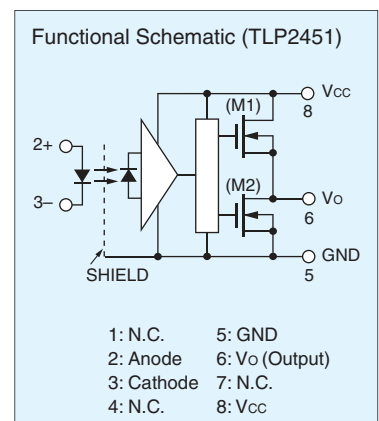
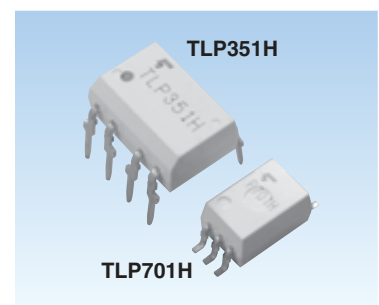

2 New Products

General-Purpose 5-Mbit/s IC-Output Photocouplers

IC-output photocouplers with a data rate of 5 Mbits/s are beneficial for applications where the user needs a data rate that is not achievable with transistor-output photocouplers. In conjunction with various packaging options, the fast IC-output photocouplers simplify system design and provide extra performance for future upgrades.

- Packaging options: MFSOP6, SDIP6, SO8
- Available in positive and negative polarity versions.
- Key specifications guaranteed over -40°C to 100°C
- Low input current: 1.6 mA max (3 mA for the TLP715 and TLP718)
- Totem-pole output: Eliminates the need for an external load resistor.
- Wide supply voltage range: 4.5 V to 20 V
- Available in dual-channel versions (TLP2105/TLP2108)
- EN60747-5-2-certified

Package	Part Number	# of Channels	Logic Polarity
MFSOP6	TLP105	1-ch	Positive
	TLP108	1-ch	Negative
SDIP6	TLP715	1-ch	Positive
	TLP718	1-ch	Negative
SO8	TLP2405	1-ch	Positive
	TLP2408	1-ch	Negative
	TLP2105	2-ch	Positive
	TLP2108	2-ch	Negative

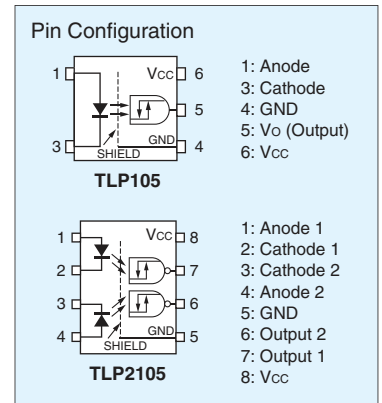
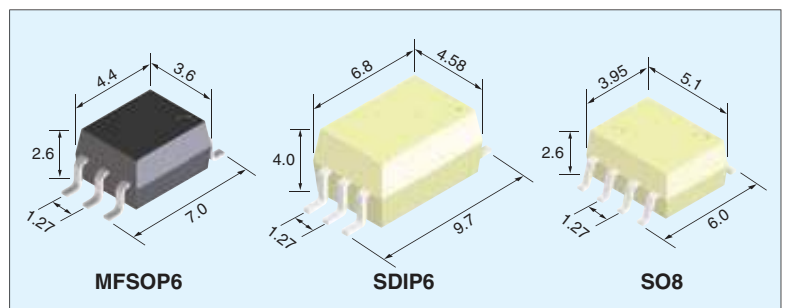

IC-Output Photocouplers for IPM Drive Applications

Toshiba offers IC-output photocouplers ideal for IPM drive applications. Compared to the conventional TLP114A (IGM), these IC-output photocouplers provide shorter propagation delay times, a wider operating temperature range and digital output. Thus, they help to simplify system design and improve system performance. The TLP104 and TLP2404 in a small surface-mount package are now available in mass-production quantities, while those in the SDIP6 and DIP8 packages will shortly be available.

- Wide packaging options: SO6, SO8, SDIP6, DIP8
- Key specifications are guaranteed over -40°C to 125°C .
- Low current consumption: 5 mA (max)
- Wide supply voltage range: 4.5 to 30 V
- Propagation delay times: $t_{pHL} = 400$ ns (max), $t_{pLH} = 550$ ns (max)
- Propagation delay skew: $t_{pHL} - t_{pLH} = 400$ ns (max)

Part Number	Package	Feature
TLP104	SO6	Small surface-mount package with a 2.3-mm PCB mounted height (max)
TLP2404	SO8	Standard 8-pin small surface-mount package
TLP714*	SDIP6	Small surface-mount SDIP6 package
TLP754*	DIP8	Standard DIP8 package

*Under development. Specifications subject to change without notice. For the latest information, please contact your nearest Toshiba sales representative.

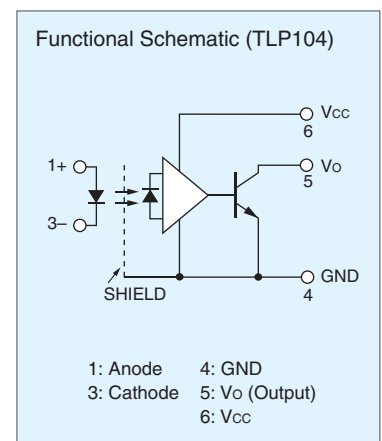
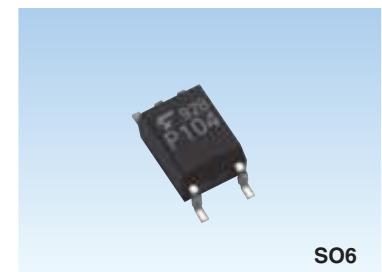

Photorelays in the Ultra-Small USOP4 Package: TLP33xx Series

There is a strong market need for smaller photorelays. To meet this need, Toshiba has developed photorelays in the ultra-small USOP4 package, which are suitable for high-density board assembly. These photorelays help to reduce system size and cost. They are ideal for use in small measuring instruments such as semiconductor testers that require numerous relays. The TLP3312 and TLP3375 provide well-balanced off-state voltage and on-state current, making them suitable not only for tester applications but also for various applications requiring high-density board assembly such as battery-controlled devices.

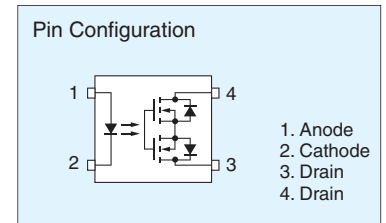
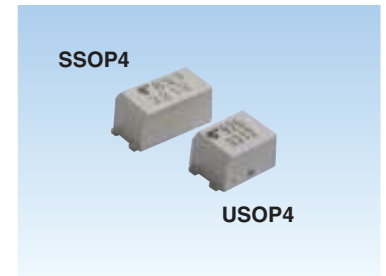
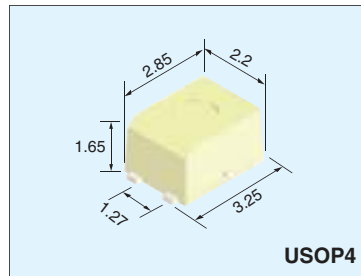

Part Number	Off-State Voltage (max)	On-State Current (max)	On-State Resistance (max)	Total Capacitance (typ.)	LED Trigger Current (max)
TLP3312	60 V	0.4 A	1.5 Ω	20 pF	3 mA
TLP3375	50 V	0.3 A	1.5 Ω	12 pF	3 mA

High-ION Photorelays: TLP354x Series (Under Development)

Toshiba is now developing the TLP354x Series in the DIP6 package targeting applications that deal with relatively large current. Housed in the DIP6 package, the TLP354x photorelays allow B and C connections, enabling the switching of 8-A, 7-A, 6-A and 4-A dc current respectively. They are suitable for various applications such as factory equipment, power supplies and security systems.

Scheduled for mass production in April

Characteristic	Symbol	Unit	Available	Under Development			
			TLP3542	TLP3543	TLP3544	TLP3545	TLP3546
Package	-	-	DIP6				
Peak Off-State Voltage (min)	V_{OFF}	V	40	20	40	60	100
On-State Current (max)	I_{ON}	A	2.5	4	3.5	3	2
On-State Resistance (max)	R_{ON}	$m\Omega$	100	50	60	70	200
Isolation Voltage (min)	B_{VS}	V_{rms}	2500	2500	2500	2500	2500

*Under development. Specifications subject to change without notice.
For the latest information, please contact your nearest Toshiba sales representative.

2 New Products

General-Purpose Photorelays Certified for Reinforced Insulation: TLP220 Series and TLP221A (Under Development)

Toshiba is now developing the TLP220 Series and the TLP221 targeting factory equipment applications, and wattmeter and smart meter applications for the monitoring of electrical energy consumption. These photorelays meet the requirements for high isolation voltage between input and output, as well as for international safety standards certification. Housed in the DIP4 package, the new photorelays save board space and provide an isolation voltage of 5 kV. The TLP220 Series is available in versions with 60-V, 200-V, 350-V, 400-V and 600-V peak off-state voltages. The TLP221A provides a 60-V peak off-state voltage and a 1.5-A on-state current.

Scheduled for mass production in June to August

Characteristic	Symbol	Unit	Existing Photorelay Examples		Under Development					
			TLP222A	TLP222G	TLP220A	TLP220D	TLP220G	TLP220GA	TLP220J	TLP221A
Package	-	-	DIP4							
Peak Off-State Voltage (min)	V _{OFF}	V	60	350	60	200	350	400	600	60
On-State Current (max)	I _{ON}	A	0.5	0.12	0.5	0.25	0.1	0.12	0.09	1.5
On-State Resistance (max)	R _{ON}	Ω	2	50	2	8	50	35	60	0.2
Isolation Voltage (min)	B _{VS}	V _{rms}	5000	5000	5000	5000	5000	5000	5000	5000

*Under development. Specifications subject to change without notice.
For the latest information, please contact your nearest Toshiba sales representative.

IC-Output Photocouplers in the SO6 Package Certified for Reinforced Insulation

Despite the same footprint size as the MFSOP6 package, the new SO6 package provides reinforced insulation, offering clearance and creepage distances of ≥ 5 mm; an internal isolation thickness of ≥ 0.4 mm; and an isolation voltage of 3750 V_{rms}.

Additionally, the SO6 features the maximum PCB mounted height of 2.3 mm, approximately 20% lower than the MFSOP6. This makes the photocouplers in SO6 ideal for low-profile applications.

- Clearance/creepage: ≥ 5 mm
- Thin package: ≤ 2.3 mm
- Internal Faraday shield: ≥ 0.4 mm
- Thin package: ≤ 2.3 mm

Part Number	Data rate (typ.)	Output	Supply voltage	Input Threshold Current (max)
TLP104	1 Mbit/s	Open-collector, optimized for IPM drive	4.5 V to 30 V	5 mA
TLP109	1 Mbit/s	Open-collector	4.5 V to 30 V	-
TLP116A	20 Mbit/s	Totem-pole inverting logic	5 V	5 mA
TLP2366*			3.3 V/5 V	5 mA
TLP118	20 Mbit/s	Open-collector inverting logic	5 V	5 mA
TLP2368*			3.3 V/5 V	5 mA
TLP2367*	50 Mbit/s	Totem-pole inverting logic	3.3 V/5 V	5 mA

*Under development. Specifications subject to change without notice.
For the latest information, please contact your nearest Toshiba sales representative.

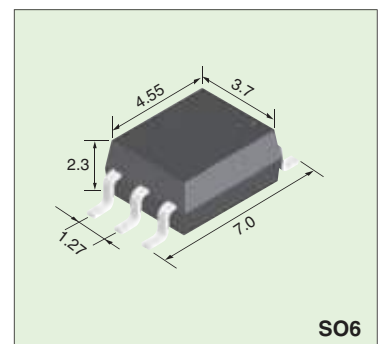
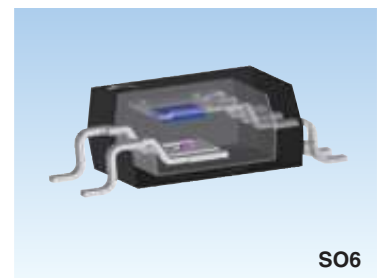

3 Photocoupler Product Tree

Photocoupler Product Tree

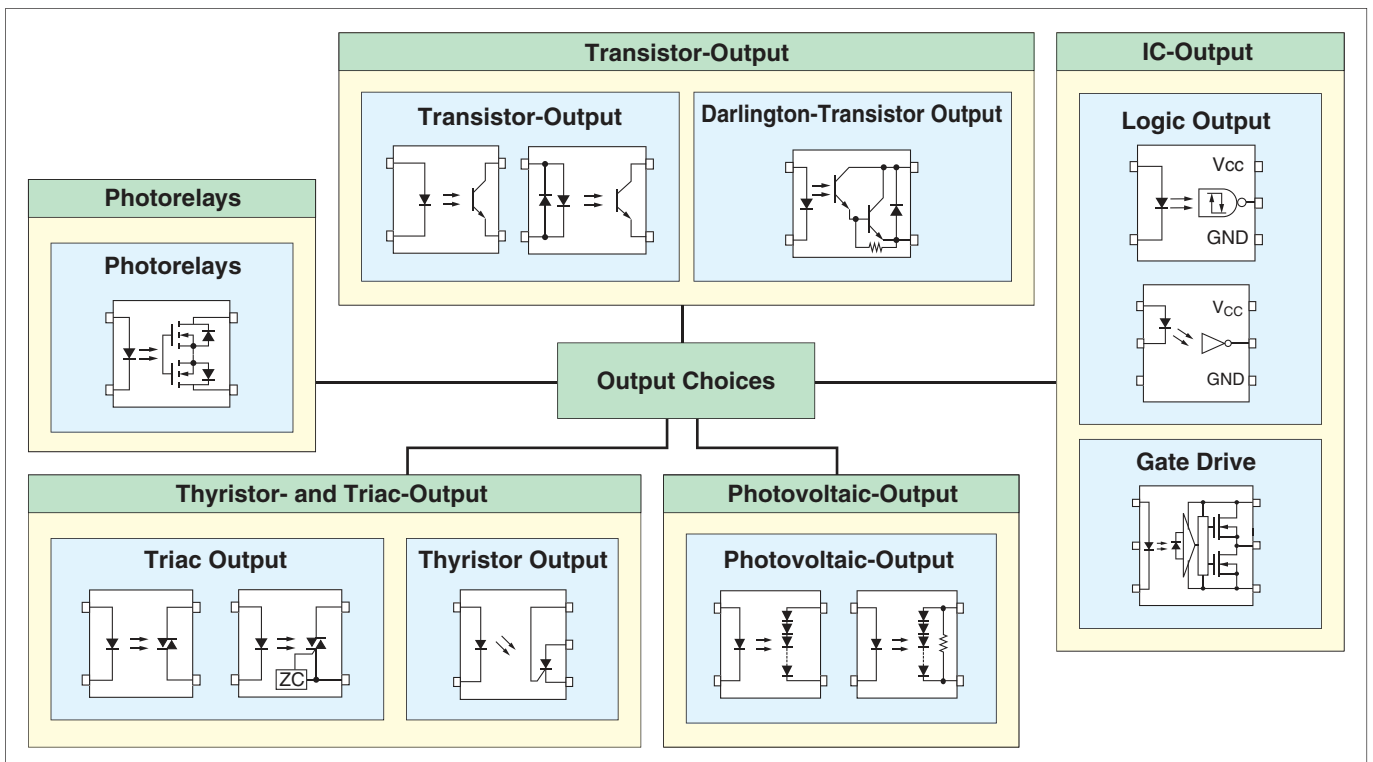
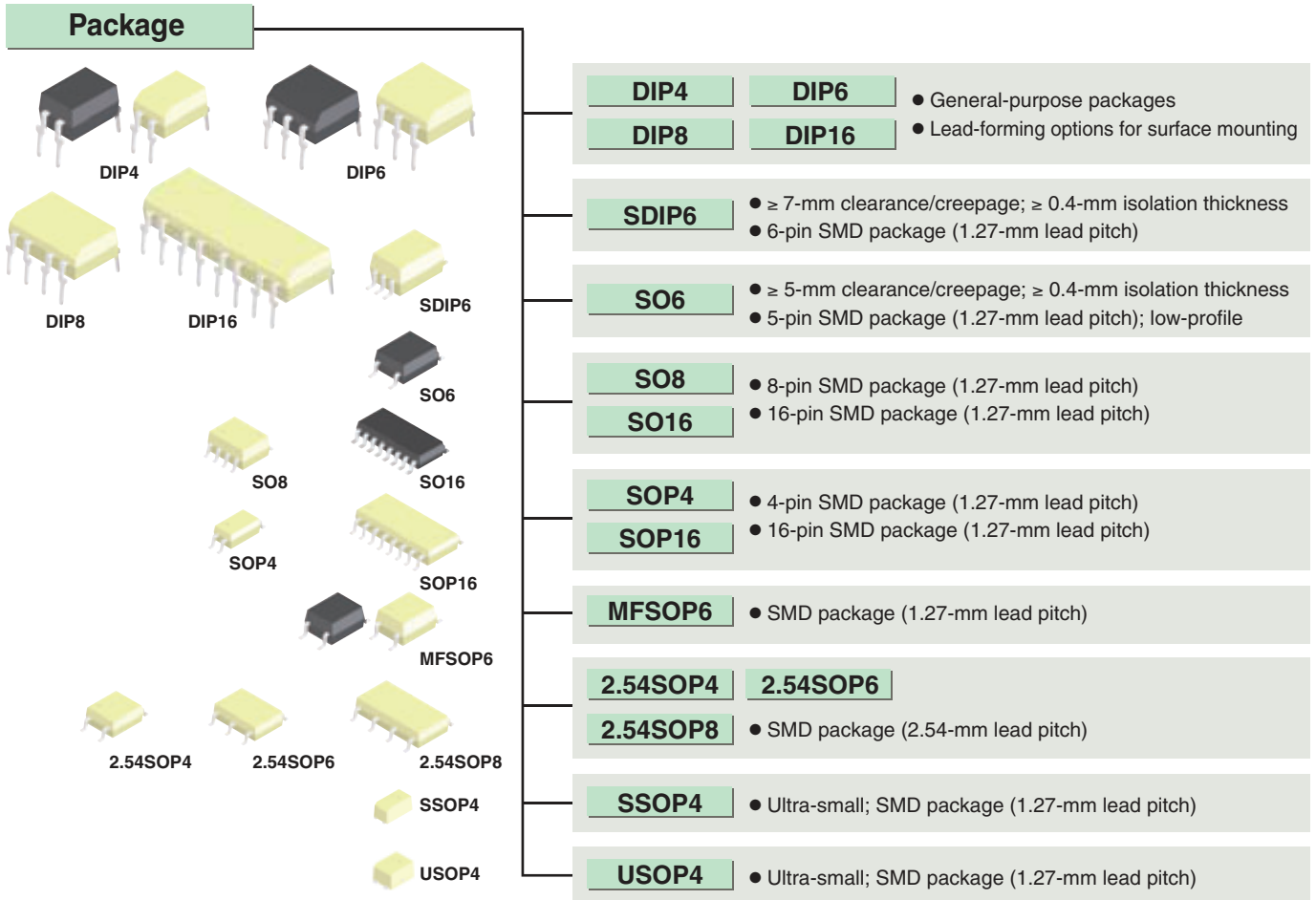

4 Selection Guide

1 Transistor-Output and Darlington-Transistor-Output Photocouplers

Features		Package									
											
		SOP4	SOP16	SO6	SO16	MFSOP6	DIP6	DIP4	DIP8	DIP16	
Isolation Voltage	Channel	Single	Quad	Single	Quad	Single	Single	Single	Dual	Quad	
	General-purpose	2500 Vrms	TLP281	TLP281-4		TLP291-4*		TLP531 TLP532		TLP504A	
3750 Vrms		TLP285	TLP285-4	TLP185*		TLP131 TLP181					
4000 Vrms							TLP731 TLP732 TLP733 TLP734				
5000 Vrms							TLP631 TLP632	TLP781 TLP785			
Low I _F		3750 Vrms					TLP124 TLP137				
		5000 Vrms						TLP331 TLP332	TLP624	TLP624-2	TLP624-4
High V _{CEO}		5000 Vrms						TLP628	TLP628-2	TLP628-4	
High I _F		5000 Vrms						TLP629	TLP629-2	TLP629-4	
AC input		2500 Vrms	TLP280	TLP280-4		TLP290-4*					
		3750 Vrms	TLP284	TLP284-4	TLP184*		TLP130 TLP180				
	5000 Vrms						TLP630	TLP620	TLP620-2	TLP620-4	
	Low I _F	3750 Vrms					TLP126				
		5000 Vrms							TLP626	TLP626-2	TLP626-4
	High I _F	5000 Vrms						TLP330	TLP320	TLP320-2	TLP320-4
Darlington	2500 Vrms						TLP570 TLP571 TLP572	TLP523	TLP523-2	TLP523-4	
	High V _{CEO}	2500 Vrms					TLP127				
		5000 Vrms						TLP371 TLP372 TLP373	TLP627	TLP627-2	TLP627-4

*Under development. Specifications subject to change without notice. For the latest information, please contact your nearest Toshiba sales representative.

New Products with Reinforced Insulation in a Small, Surface-Mount SOP Package (≥ 5-mm Clearance/Creepage and ≥ 0.4-mm Internal Isolation Thickness)

Part Number	Pin Configuration	Features	CTR (%) ⁽³⁾				V _{CEO}	BV _s	Safety Standards ⁽²⁾				
			Rank	Min	Max	@ I _F , V _{CE}			UL/cUL	TÜV	VDE	BSI	IEC
TLP284 ⁽⁴⁾		SOP4 Lead pitch = 1.27 mm AC Input SEMKO-approved TST part recm'ed	–	50	600	±5 mA, 5 V	80 V	3750 Vrms	○/○	△	○ ⁽¹⁾	◎	◎
			Y	50	150								
			GR	100	300								
			BL	200	600								
			GB	100	600								
TLP284-4		SOP16 4-channel version of the TLP284 Lead pitch = 1.27 mm AC Input SEMKO-approved	–	50	600	±5 mA, 5 V	80 V	3750 Vrms	○/○	△	○ ⁽¹⁾		△
			GB	100	600								
TLP285 ⁽⁴⁾		SOP4 Lead pitch = 1.27 mm SEMKO-approved TST part recm'ed	–	50	600	5 mA, 5 V	80 V	3750 Vrms	○/○	○ ⁽¹⁾	○ ⁽¹⁾	◎	◎
			Y	50	150								
			GR	100	300								
			BL	200	600								
			GB	100	600								
			YH	75	150								
			GRL	100	200								
			GRH	150	300								
BLL	200	400											
TLP285-4		SOP16 4-channel version of the TLP285 Lead pitch = 1.27 mm SEMKO-approved	–	50	600	5 mA, 5 V	80 V	3750 Vrms	○/○	△	○ ⁽¹⁾		△
			GB	100	600								

General-Purpose, Transistor-Output Photocouplers

Part Number	Pin Configuration	Features	CTR (%) ⁽³⁾				V _{CEO}	BV _s	Safety Standards ⁽²⁾												
			Rank	Min	Max	@ I _F , V _{CE}			UL/cUL	TÜV	VDE	BSI	IEC								
TLP124		Mini-flat MFSOP6 Low input drive current	–	100	1200	1 mA, 0.5 V	80 V	3750 Vrms	○/○												
			BV	200	1200																
TLP131		Mini-flat MFSOP6 Internal base connection	–	50	600	5 mA, 5 V	80 V	3750 Vrms	○/○												
			Y	50	150																
			GR	100	300																
			BL	200	600																
TLP137		Mini-flat MFSOP6 Low input drive current Internal base connection	–	100	1200	1 mA, 0.5 V	80 V	3750 Vrms	○/○												
			BV	200	1200																
			–	50	600									5 mA, 5 V	80 V	3750 Vrms	○/○	△	○ ⁽¹⁾	◎	◎
			Y	50	150																
GR	100	300																			
BL	200	600																			
TLP181 ⁽⁴⁾		Mini-flat MFSOP6 SEMKO-approved TST part recm'ed	GR	100	300	5 mA, 5 V	80 V	3750 Vrms	○/○	△	○ ⁽¹⁾	◎	◎								
			BL	200	600																
			GB	100	600																
			YH	75	150																
			GRL	100	200																
			GRH	150	300																
			BLL	200	400																
			–	50	600									5 mA, 5 V	80 V	2500 Vrms	○/○	○ ⁽¹⁾	○ ⁽¹⁾	◎	◎
Y	50	150																			
GR	100	300																			
BL	200	600																			
GB	100	600																			
YH	75	150																			
GRL	100	200																			
GRH	150	300																			
BLL	200	400																			

Note 1: The EN60747-5-2 safety standard for compact packages is different from that for standard DIP packages.

Since the mini-flat package is a compact package, please contact your nearest Toshiba sales representative for more details.

Note 2: BSI and IEC: ○: Approved (supplementary or basic insulation) ◎: Approved (reinforced insulation) △: Design which meets safety standard/approval pending as of January 2011
EN 60065- and IEC 60065-approved, EN 60950- and IEC 60950-approved

TÜV and VDE: ○: Approved △: Design which meets safety standard/approval pending as of January 2011
EN 60747-5-2-approved with option V4 or D4

For the latest information, please contact your nearest Toshiba sales representative.

Note 3: Some CTR ranks may be limited in production quantities. For details, please contact your nearest Toshiba sales representative.

Note 4: Product manufactured by Toshiba Semiconductor (Thailand) Co.,Ltd. [TST] is recommended. See page 38 for detail. Japan product is non-promotional item.

4 Selection Guide

General-Purpose, Transistor-Output Photocouplers (Continued)

Part Number	Pin Configuration	Features	CTR (%) ⁽³⁾				V _{CEO}	BV _s	Safety Standards ⁽²⁾				
			Rank	Min	Max	@ I _F , V _{CE}			UL/cUL	TÜV	VDE	BSI	IEC
TLP281-4		SOP16 4-channel version of the TLP281 Lead pitch = 1.27 mm SEMKO-approved	–	50	600	5 mA, 5 V	80 V	2500 Vrms	○/○	△	○ ⁽¹⁾	◎	◎
			GB	100	600								
TLP331		DIP6 Low input drive current Internal base connection	–	100	1200	1 mA, 0.5 V	55 V	5000 Vrms	○/○				
			BV	200	1200								
TLP332		DIP6 Low input drive current	–	100	1200	1 mA, 0.5 V	55 V	5000 Vrms	○/○				
			BV	200	1200								
TLP504A		DIP8	–	50	600	5 mA, 5 V	55 V	2500 Vrms	○/–				
			GB	100	600								
TLP531		DIP6 Internal base connection	–	50	600	5 mA, 5 V	55 V	2500 Vrms	○/○				
			Y	50	150								
			GR	100	300								
			BL	200	600								
			GB	100	600								
TLP532		DIP6 High EMI immunity	–	50	600	5 mA, 5 V	55 V	2500 Vrms	○/○				
			Y	50	150								
			GR	100	300								
			BL	200	600								
			GB	100	600								
TLP624		DIP4 Low input drive current	–	100	1200	1 mA, 5 V	55 V	5000 Vrms	○/–	△	△	◎	◎
			BV	200	1200								
TLP624-2		DIP8 Dual-channel version of the TLP624	–	100	1200	1 mA, 5 V	55 V	5000 Vrms	○/–	△	△	◎	◎
			BV	200	1200								
TLP624-4		DIP16 4-channel version of the TLP624	–	100	1200	1 mA, 5 V	55 V	5000 Vrms	○/–	△	△	◎	◎
			BV	200	1200								
TLP628		DIP4 High V _{CEO}	–	50	600	5 mA, 5 V	350 V	5000 Vrms	○/–	△	△	△	△
			GB	100	600								

Note 1: The EN60747-5-2 safety standard for compact packages is different from that for standard DIP packages.

Since the mini-flat package is a compact package, please contact your nearest Toshiba sales representative for more details.

Note 2: BSI and IEC: ○: Approved (supplementary or basic insulation) ◎: Approved (reinforced insulation) △: Design which meets safety standard/approval pending as of January 2011
EN 60065- and IEC 60065-approved, EN 60950- and IEC 60950-approved

TÜV and VDE: ○: Approved △: Design which meets safety standard/approval pending as of January 2011

EN 60747-5-2-approved with option V4 or D4

For the latest information, please contact your nearest Toshiba sales representative.

Note 3: Some CTR ranks may be limited in production quantities. For details, please contact your nearest Toshiba sales representative.

General-Purpose, Transistor-Output Photocouplers (Continued)

Part Number	Pin Configuration	Features	CTR (%) ⁽³⁾				V _{CEO}	BV _s	Safety Standards ⁽²⁾				
			Rank	Min	Max	@ I _F , V _{CE}			UL/cUL	TÜV	VDE	BSI	IEC
TLP628-2		DIP8 Dual-channel version of the TLP628	-	50	600	5 mA, 5 V	350 V	5000 Vrms	○/—	△	△	△	△
			GB	100	600								
TLP628-4		DIP16 4-channel version of the TLP628	-	50	600	5 mA, 5 V	350 V	5000 Vrms	○/—	△	△	△	△
			GB	100	600								
TLP629		DIP4 High input current I _F = 150 mA	-	20	80	100 mA, 1 V	55 V	5000 Vrms	○/—	△	△	△	△
TLP629-2		DIP8 Dual-channel version of the TLP629	-	20	80	100 mA, 1 V	55 V	5000 Vrms	○/—	△	△	△	△
TLP629-4		DIP16 4-channel version of the TLP629	-	20	80	100 mA, 1 V	55 V	5000 Vrms	○/—	△	△	△	△
TLP631		DIP6 Internal base connection	-	50	600	5 mA, 5 V	55 V	5000 Vrms	○/○				
			GB	100	600								
			GR	100	300								
TLP632		DIP6 High EMI immunity	-	50	600	5 mA, 5 V	55 V	5000 Vrms	○/○				
			GB	100	600								
			GR	100	300								
TLP731		DIP6 SEMKO-approved Internal base connection	-	50	600	5 mA, 5 V	55 V	4000 Vrms	○/○	△	○	◎	◎
			GB	100	600								
			GR	100	300								
TLP732		DIP6 SEMKO-approved	-	50	600	5 mA, 5 V	55 V	4000 Vrms	○/○	△	○	◎	◎
			GB	100	600								
			GR	100	300								
TLP733 TLP733F		DIP6 SEMKO-approved Internal base connection	-	50	600	5 mA, 5 V	55 V	4000 Vrms	○/—	△	○	◎	◎
			GB	100	600								
			GR	100	300								

Note 1: The EN60747-5-2 safety standard for compact packages is different from that for standard DIP packages.

Since the mini-flat package is a compact package, please contact your nearest Toshiba sales representative for more details.

Note 2: BSI and IEC: ○: Approved (supplementary or basic insulation) ◎: Approved (reinforced insulation) △: Design which meets safety standard/approval pending as of January 2011

EN 60065- and IEC 60065-approved, EN 60950- and IEC 60950-approved

TÜV and VDE: ○: Approved △: Design which meets safety standard/approval pending as of January 2011

EN 60747-5-2-approved with option V4 or D4

For the latest information, please contact your nearest Toshiba sales representative.

Note 3: Some CTR ranks may be limited in production quantities. For details, please contact your nearest Toshiba sales representative.

4 Selection Guide

General-Purpose, Transistor-Output Photocouplers (Continued)

Part Number	Pin Configuration	Features	CTR (%) ⁽³⁾				V _{CEO}	BV _s	Safety Standards ⁽²⁾				
			Rank	Min	Max	@ I _F , V _{CE}			UL/cUL	TÜV	VDE	BSI	IEC
TLP734 TLP734F		DIP6 SEMKO-approved	–	50	600	5 mA, 5 V	55 V	4000 Vrms	○/–	△	○	◎	◎
			GB	100	600								
			GR	100	300								
TLP781 ⁽⁶⁾ TLP781F ⁽⁶⁾		DIP 4 High isolation voltage UL-approved (double protection)	–	50	600	5 mA, 5 V	80 V	5000 Vrms	○/○ ⁽⁵⁾	△	○	◎	◎
			Y	50	150								
			GR	100	300								
			BL	200	600								
			GB	100	600								
			YH	75	150								
			GRL	100	200								
			GRH	150	300								
BLL	200	400											
TLP785* ⁽⁶⁾ TLP785F* ⁽⁶⁾		DIP 4 High isolation voltage UL-approved (double protection)	–	50	600	5 mA, 5 V	80 V	5000 Vrms	○/○ ⁽⁵⁾	△	△	△	△
			Y	50	150								
			GR	100	300								
			BL	200	600								
			GB	100	600								
			YH	75	150								
			GRL	100	200								
			GRH	150	300								
BLL	200	400											

AC-Input, Transistor-Output Photocouplers

Part Number	Pin Configuration	Features	CTR (%) ⁽³⁾				V _{CEO}	BV _s	Safety Standards ⁽²⁾				
			Rank	Min	Max	@ I _F , V _{CE}			UL/cUL	TÜV	VDE	BSI	IEC
TLP126		Mini-flat MFSOP6 AC input Low input drive current	–	100	1200	±1 mA, 0.5 V	80 V	3750 Vrms	○/○				
TLP130		Mini-flat MFSOP6 AC input Internal base connection	–	50	600	±5 mA, 5 V	80 V	3750 Vrms	○/○				
			GB	100	600								
TLP180 ⁽⁴⁾		Mini-flat MFSOP6 AC input SEMKO-approved TST part recm'ed	–	50	600	±5 mA, 5 V	80 V	3750 Vrms	○/○	○ ⁽¹⁾	○ ⁽¹⁾	◎	◎
			Y	50	150								
			GR	100	300								
			BL	200	600								
			GB	100	600								
TLP280 ⁽⁴⁾		SOP4 Lead pitch = 1.27 mm AC input SEMKO-approved TST part recm'ed	–	50	600	±5 mA, 5 V	80 V	2500 Vrms	○/○	○ ⁽¹⁾	○ ⁽¹⁾	◎	◎
			Y	50	150								
			GR	100	300								
			BL	200	600								
TLP280-4		SOP16 4-channel version of the TLP280 Lead pitch = 1.27 mm AC input SEMKO-approved	–	50	600	±5 mA, 5 V	80 V	2500 Vrms	○/○	△	○ ⁽¹⁾	◎	◎
			GB	100	600								

*Under development. Specifications subject to change without notice. For the latest information, please contact your nearest Toshiba sales representative.

Note 1: The EN60747-5-2 safety standard for compact packages is different from that for standard DIP packages.

Since the mini-flat package is a compact package, please contact your nearest Toshiba sales representative for more details.

Note 2: BSI and IEC: ○: Approved (supplementary or basic insulation) ◎: Approved (reinforced insulation) △: Design which meets safety standard/approval pending as of January 2011
EN 60065- and IEC 60065-approved, EN 60950- and IEC 60950-approved

TÜV and VDE: ○: Approved △: Design which meets safety standard/approval pending as of January 2011

EN 60747-5-2-approved with option V4 or D4

For the latest information, please contact your nearest Toshiba sales representative.

Note 3: Some CTR ranks may be limited in production quantities. For details, please contact your nearest Toshiba sales representative.

Note 4: Product manufactured by Toshiba Semiconductor (Thailand) Co.,Ltd. [TST] is recommended. See page 38 for detail. Japan product is non-promotional item.

Note 5: For safety standard compliance criteria including the operating temperature conditions, please contact your nearest Toshiba representative.

Note 6: About the package dimensions and lead form options, see each datasheet.

AC-Input, Transistor-Output Photocouplers (Continued)

Part Number	Pin Configuration	Features	CTR (%) ⁽³⁾				V _{CEO}	BV _s	Safety Standards ⁽²⁾				
			Rank	Min	Max	@ I _F , V _{CE}			UL/cUL	TÜV	VDE	BSI	IEC
TLP320		DIP4 High input current AC input I _F = 150 mA	–	20	80	±100 mA, 1 V	55 V	5000 Vrms	○/○			○	○
TLP320-2		DIP8 Dual-channel version of the TLP320	–	20	80	±100 mA, 1 V	55 V	5000 Vrms	○/○			○	○
TLP320-4		DIP16 4-channel version of the TLP320	–	20	80	±100 mA, 1 V	55 V	5000 Vrms	○/○			○	○
TLP330		DIP6 High input current AC input I _F = 150 mA Internal base connection	–	20	80	±100 mA, 1 V	55 V	5000 Vrms	○/○				
TLP620 ⁽⁴⁾ TLP620F ⁽⁴⁾		DIP4 AC input SEMKO-approved TST part recm'ed	–	50	600	±5 mA, 5 V	55 V	5000 Vrms	○/○	△	○	○	○
			Y	50	150								
			GR	100	300								
			BL	200	600								
TLP620-2 ⁽⁴⁾ TLP620F-2 ⁽⁴⁾		DIP8 Dual-channel version of the TLP620 SEMKO-approved TST part recm'ed	–	50	600	±5 mA, 5 V	55 V	5000 Vrms	○/○	△	○	○	○
			GB	100	600								
TLP620-4		DIP16 4-channel version of the TLP620	–	50	600	±5 mA, 5 V	55 V	5000 Vrms	○/○	△	○	○	○
			GB	100	600								
TLP626		DIP4 Low input drive current AC input	–	100	1200	±1 mA, 0.5 V	55 V	5000 Vrms	○/–	△	△	○	○
			BV	200									
TLP626-2		DIP8 Dual-channel version of the TLP626	–	100	1200	±1 mA, 0.5 V	55 V	5000 Vrms	○/–	△	△	○	○
			BV	200									
TLP626-4		DIP16 4-channel version of the TLP626	–	100	1200	±1 mA, 0.5 V	55 V	5000 Vrms	○/–	△	△	○	○
			BV	200									
TLP630		DIP6 AC input High isolation voltage Internal base connection	–	50	600	±5 mA, 5 V	55 V	5000 Vrms	○/○				
			GB	100									

Note 1: The EN60747-5-2 safety standard for compact packages is different from that for standard DIP packages.

Since the mini-flat package is a compact package, please contact your nearest Toshiba sales representative for more details.

Note 2: BSI and IEC: ○: Approved (supplementary or basic insulation) ◎: Approved (reinforced insulation) △: Design which meets safety standard/approval pending as of January 2011

EN 60065- and IEC 60065-approved, EN 60950- and IEC 60950-approved

TÜV and VDE: ○: Approved △: Design which meets safety standard/approval pending as of January 2011

EN 60747-5-2-approved with option V4 or D4

For the latest information, please contact your nearest Toshiba sales representative.

Note 3: Some CTR ranks may be limited in production quantities. For details, please contact your nearest Toshiba sales representative.

Note 4: Product manufactured by Toshiba Semiconductor (Thailand) Co., Ltd. [TST] is recommended. See page 38 for detail. Japan product is non-promotional item.

4 Selection Guide

Darlington-Transistor-Output Photocouplers

Part Number	Pin Configuration	Features	CTR (%) ⁽³⁾		V _{CE (sat)}		V _{CEO}	BV _s	Safety Standards ⁽²⁾				
			Min	@I _F , V _{CE}	Max	@I _C , I _F			UL/cUL	TÜV	VDE	BSI	IEC
TLP127		Mini-flat MFSOP6 High V _{CEO}	1000	1 mA, 1 V	1.2 V	100 mA, 10 mA	300 V	2500 Vrms	○/○	△	○ ⁽¹⁾	○	○
TLP371		DIP6 High V _{CEO} SEMKO-approved Internal base connection	1000	1 mA, 1 V	1.2 V	100 mA, 10 mA	300 V	5000 Vrms	○/○			△	△
TLP372		DIP6 High V _{CEO} SEMKO-approved	1000	1 mA, 1 V	1.2 V	100 mA, 10 mA	300 V	5000 Vrms	○/○			△	△
TLP373		DIP6 High V _{CEO} Long emitter-collector distance SEMKO-approved	1000	1 mA, 1 V	1.2 V	100 mA, 10 mA	300 V	5000 Vrms	○/○			△	△
TLP523		DIP4	500	1 mA, 1 V	1 V	50 mA, 10 mA	55 V	2500 Vrms	○/○				
TLP523-2		DIP8 Dual-channel version of the TLP523	500	1 mA, 1 V	1 V	50 mA, 10 mA	55 V	2500 Vrms	○/○				
TLP523-4		DIP16 4-channel version of the TLP523	500	1 mA, 1 V	1 V	50 mA, 10 mA	55 V	2500 Vrms	○/○				
TLP570		DIP6 High EMI immunity	1000	1 mA, 1 V	1.2 V	100 mA, 10 mA	35 V	2500 Vrms	○/○				
TLP571		DIP6 Internal base connection	1000	1 mA, 1 V	1.2 V	100 mA, 10 mA	35 V	2500 Vrms	○/—				
TLP572		DIP6 Built-in R _{BE}	1000	1 mA, 1.2 V	1.2 V	100 mA, 10 mA	55 V	2500 Vrms	○/—				
TLP627 ⁽⁴⁾		DIP4 High V _{CEO} SEMKO-approved TST part recm'd	1000	1 mA, 1 V	1.2 V	100 mA, 10 mA	300 V	5000 Vrms	○/○	△	○	○	○
TLP627-2 ⁽⁴⁾		DIP8 Dual-channel version of the TLP627 SEMKO-approved TST part recm'd	1000	1 mA, 1 V	1.2 V	100 mA, 10 mA	300 V	5000 Vrms	○/○	△	○	○	○
TLP627-4		DIP16 4-channel version of the TLP627	1000	1 mA, 1 V	1.2 V	100 mA, 10 mA	300 V	5000 Vrms	○/○	△	○	○	○

Note 1: The EN60747-5-2 safety standard for compact packages is different from that for standard DIP packages.

Since the mini-flat package is a compact package, please contact your nearest Toshiba sales representative for more details.

Note 2: BSI and IEC: ○: Approved (supplementary or basic insulation) ◎: Approved (reinforced insulation) △: Design which meets safety standard/approval pending as of January 2011
EN 60065- and IEC 60065-approved, EN 60950- and IEC 60950-approved

TÜV and VDE: ○: Approved △: Design which meets safety standard/approval pending as of January 2011







EN 60747-5-2-approved with option V4 or D4

For the latest information, please contact your nearest Toshiba sales representative.

Note 3: Some CTR ranks may be limited in production quantities. For details, please contact your nearest Toshiba sales representative.

Note 4: Product manufactured by Toshiba Semiconductor (Thailand) Co.,Ltd. [TST] is recommended. See page 38 for detail. Japan product is non-promotional item.

2 Photocouplers for Logic Signal Transmission

Package										
Data Rate (Typ.)	Output	MFSOP6	SO6	SO8		SDIP6	DIP6	DIP8		JEDEC
				1ch	2ch			1ch	2ch	
0.3 Mbit/s	Open-collector (Darlington)			TLP2403				TLP553		6N138 6N139
1 Mbit/s	Open-collector	(TLP112)* ² (TLP112A)* ² (TLP114A)* ²	TLP109	TLP2409		TLP719	TLP512	TLP550 TLP551 TLP559 TLP651 TLP750 TLP751 TLP759	TLP2530 TLP2531	6N135 6N136
		IPM drive (TLP114A(IGM))* ³	TLP109(IGM) TLP104	TLP2409(IGM) TLP2404			TLP714* ¹	TLP559(IGM) TLP759(IGM) TLP754* ¹		
5 Mbit/s	Totem-pole	TLP105 TLP108		TLP2405 TLP2408	TLP2105 TLP2108	TLP715 TLP718				
	Dual polarity input	TLP2095 TLP2098								
	3-state							TLP555 TLP558 TLP2200		
10 Mbit/s	Open-collector	(TLP113)* ⁴ (TLP115)* ⁴ (TLP115A)* ⁴					TLP513	TLP552 TLP554 TLP2601	TLP2630 TLP2631	6N137
15 to 20 Mbit/s	Totem-pole	5 V (TLP116)* ⁵	TLP116A			TLP2116	TLP716			
		3.3 V TLP2066				TLP2166A				
	Open-collector	3.3 V/5 V		TLP2366* ¹	TLP2466* ¹	TLP2160* ¹	TLP2766* ¹			
		5 V		TLP118	TLP2418	TLP2118	TLP708			
50 Mbit/s	Totem-pole	3.3 V/5 V		TLP2368* ¹	TLP2468* ¹	TLP2168* ¹	TLP2768* ¹			
		5 V TLP117								
		3.3 V/5 V		TLP2367* ¹	TLP2467* ¹	TLP2167* ¹	TLP2767* ¹			

*1: Under development as of January 2011. For the latest information, please contact your nearest Toshiba sales representative.

*2: TLP109 recommended

*3: TLP109(IGM) recommended

*4: TLP118 recommended

*5: TLP116A recommended

Photocouplers for Logic Signal Transmission at 40 to 50 Mbit/s (Typ.)

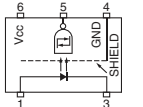
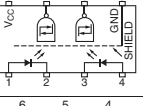
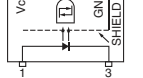
Part Number	Pin Configuration	Features	Data Rate (NRZ) (Typ.)	Output Form	I _{FHL} (Max)	BV _s	Safety Standards ⁽²⁾				
							UL/cUL	TÜV	VDE	BSI	IEC
TLP117		Mini-flat MFSOP6 Propagation delay time: 30 ns (max) V _{CC} = 5 V	50 Mbit/s	Totem pole output (Inverter logic)	5 mA	3750 Vrms	○/○	○ ⁽¹⁾	○ ⁽¹⁾		
TLP2167*		SO8 V _{CC} = 3.3 or 5 V T _{opr} (max) 125°C	40 Mbit/s	Totem pole output (Inverter logic)	5 mA	2500 Vrms	△/△		△ ⁽¹⁾		
TLP2367*		SO6 (reinforced insulation) V _{CC} = 3.3 or 5 V T _{opr} (max) 125°C	40 Mbit/s	Totem pole output (Inverter logic)	5 mA	3750 Vrms	△/△		△ ⁽²⁾		

*Under development. Specifications subject to change without notice. For the latest information, please contact your nearest Toshiba sales representative.

Note 1: The EN60747-5-2 safety standard for compact packages is different from that for standard DIP packages.

Since the mini-flat package is a compact package, please contact your nearest Toshiba sales representative for more details.

Note 2: BSI and IEC: ○: Approved (supplementary or basic insulation) ◎: Approved (reinforced insulation) △: Design which meets safety standard/approval pending as of January 2011

EN 60065- and IEC 60065-approved, EN 60950- and IEC 60950-approved

TÜV and VDE: ○: Approved △: Design which meets safety standard/approval pending as of January 2011

EN 60747-5-2-approved with option V4 or D4

For the latest information, please contact your nearest Toshiba sales representative.

4 Selection Guide

Photocouplers for Logic Signal Transmission at 40 to 50 Mbit/s (Typ.) (Continued)

Part Number	Pin Configuration	Features	Data Rate (NRZ) (Typ.)	Output Form	I _{FHL} (Max)	BV _s	Safety Standards ⁽²⁾				
							UL/cUL	TÜV	VDE	BSI	IEC
TLP2467*		SO8 V _{CC} = 3.3 or 5 V T _{opr} (max) 125°C	40 Mbit/s	Totem pole output (Inverter logic)	5 mA	3750 Vrms	△ / △		△ ⁽¹⁾		
TLP2767*		SDIP6 (reinforced insulation) V _{CC} = 3.3 or 5 V T _{opr} (max) 125°C	40 Mbit/s	Totem pole output (Inverter logic)	5 mA	5000 Vrms	△ / △		△		

Photocouplers for Logic Signal Transmission at 15 to 20 Mbit/s (Typ.)

Part Number	Pin Configuration	Features	Propagation Delay Time (Max)	Output Form	I _{FHL} (Max)	BV _s	Safety Standards ⁽²⁾				
							UL/cUL	TÜV	VDE	BSI	IEC
TLP116A		SO6 (reinforced insulation) High speed: 20 Mbit/s V _{CC} = 5 V	60 ns	Totem pole output (Inverter logic)	5 mA	3750 Vrms	○ / ○	○ ⁽¹⁾	○ ⁽¹⁾		
TLP2116		SO8 High speed: 15 Mbit/s V _{CC} = 5 V Dual-channel version	75 ns	Totem pole output (Inverter logic)	5 mA	2500 Vrms	○ / ○	○ ⁽¹⁾	○ ⁽¹⁾		
TLP716 TLP716F		SDIP6 High speed: 15 Mbit/s V _{CC} = 5 V High isolation voltage	75 ns	Totem pole output (Inverter logic)	6.5 mA	5000 Vrms	○ / ○	○	○		
TLP118		SO6 (reinforced insulation) High speed: 20 Mbit/s V _{CC} = 5 V T _{opr} = 125°C (max)	60 ns	Open-collector (Inverter logic)	5 mA	3750 Vrms	○ / ○		○ ⁽¹⁾		
TLP2418*		SO8 High speed: 15 Mbit/s V _{CC} = 5 V	75 ns	Open-collector (Inverter logic)	5 mA	3750 Vrms	○ / ○		○ ⁽¹⁾		
TLP2118E*		SO8 High speed: 15 Mbit/s V _{CC} = 5 V	75 ns	Open-collector (Inverter logic)	5 mA	2500 Vrms	○ / ○		○ ⁽¹⁾		
TLP708*		SDIP6 High speed: 15 Mbit/s V _{CC} = 5 V High isolation voltage	75 ns	Open-collector (Inverter logic)	5 mA	5000 Vrms	○ / ○		○		
TLP2066		Mini-flat MFSOP6 High speed: 20 Mbit/s V _{CC} = 3.3 V	60 ns	Totem pole output (Inverter logic)	5 mA	3750 Vrms	○ / ○	○ ⁽¹⁾	○ ⁽¹⁾		

*Under development. Specifications subject to change without notice. For the latest information, please contact your nearest Toshiba sales representative.

Note 1: The EN60747-5-2 safety standard for compact packages is different from that for standard DIP packages.

Since the mini-flat package is a compact package, please contact your nearest Toshiba sales representative for more details.

Note 2: BSI and IEC: ○: Approved (supplementary or basic insulation) ◎: Approved (reinforced insulation) △: Design which meets safety standard/approval pending as of January 2011

EN 60065- and IEC 60065-approved, EN 60950- and IEC 60950-approved

TÜV and VDE: ○: Approved △: Design which meets safety standard/approval pending as of January 2011

EN 60747-5-2-approved with option V4 or D4

For the latest information, please contact your nearest Toshiba sales representative.

Photocouplers for Logic Signal Transmission at 15 to 20 Mbit/s (Typ.) (Continued)

Part Number	Pin Configuration	Features	Data Rate (NRZ) (Typ.)	Output Form	I _{FHL} (Max)	BV _s	Safety Standards ⁽²⁾				
							UL/cUL	TÜV	VDE	BSI	IEC
TLP2160*		SO8 V _{CC} = 3.3 or 5 V T _{opr} = 125°C (max) Dual-channel version	20 Mbit/s	Totem pole output (Inverter logic)	3.5 mA	2500 Vrms	△ / △		△ ⁽¹⁾		
TLP2168*		SO8 V _{CC} = 3.3 or 5 V T _{opr} = 125°C (max) Dual-channel version	20 Mbit/s	Open-collector (Inverter logic)	5 mA	3750 Vrms	○ / ○		○ ⁽¹⁾		
TLP2366*		SO6 (reinforced insulation) V _{CC} = 3.3 or 5 V T _{opr} = 125°C (max)	20 Mbit/s	Totem pole output (Inverter logic)	3.5 mA	3750 Vrms	△ / △		△ ⁽¹⁾		
TLP2368*		SO6 (reinforced insulation) V _{CC} = 3.3 or 5 V T _{opr} = 125°C (max)	20 Mbit/s	Open-collector (Inverter logic)	5 mA	3750 Vrms	△ / △		△ ⁽¹⁾		
TLP2466*		SO8 V _{CC} = 3.3 or 5 V T _{opr} = 125°C (max)	20 Mbit/s	Totem pole output (Inverter logic)	3.5 mA	3750 Vrms	△ / △		△ ⁽¹⁾		
TLP2468		SO8 V _{CC} = 3.3 or 5 V T _{opr} = 125°C (max)	20 Mbit/s	Open-collector (Inverter logic)	5 mA	3750 Vrms	○ / ○		○ ⁽¹⁾		
TLP2766*		SDIP6 V _{CC} = 3.3 or 5 V T _{opr} = 125°C (max)	20 Mbit/s	Totem pole output (Inverter logic)	3.5 mA	5000 Vrms	△ / △		△		
TLP2768*		SDIP6 V _{CC} = 3.3 or 5 V T _{opr} = 125°C (max)	20 Mbit/s	Open-collector (Inverter logic)	5 mA	5000 Vrms	△ / △		△		
TLP2166A		SO8 Propagation delay time: 75 ns V _{CC} = 3.3 V Dual-channel version	15 Mbit/s	Totem pole output (Inverter logic)	3 mA	2500 Vrms	○ / ○		○ ⁽¹⁾		

Photocouplers for Logic Signal Transmission at 10 Mbit/s (Typ.)

Part Number	Pin Configuration	Features	Propagation Delay Time (Max)	Output Form	I _{FHL} , I _{FLH} (Max)	BV _s	Safety Standards ⁽²⁾				
							UL/cUL	TÜV	VDE	BSI	IEC
TLP513		DIP6 6-pin package version of the TLP552 V _{CC} = 5 V	120 ns (T _{opr} = 25°C)	Open-collector	5 mA	2500 Vrms	○ / -				
TLP552		DIP8 Logic output V _{CC} = 5 V	120 ns (T _{opr} = 25°C)	Open-collector	5 mA	2500 Vrms	○ / -				
TLP554		DIP8 High CMR version of the TLP552 V _{CC} = 5 V	120 ns (T _{opr} = 25°C)	Open-collector	5 mA	2500 Vrms	○ / ○				
TLP2601		DIP8 High CMR V _{CC} = 5 V	75 ns (T _{opr} = 25°C)	Open-collector	5 mA	2500 Vrms	○ / ○				

*Under development. Specifications subject to change without notice. For the latest information, please contact your nearest Toshiba sales representative.

Note 1: The EN60747-5-2 safety standard for compact packages is different from that for standard DIP packages.

Since the mini-flat package is a compact package, please contact your nearest Toshiba sales representative for more details.

Note 2: BSI and IEC: ○: Approved (supplementary or basic insulation) △: Design which meets safety standard/approval pending as of January 2011

EN 60065- and IEC 60065-approved, EN 60950- and IEC 60950-approved

TÜV and VDE: ○: Approved △: Design which meets safety standard/approval pending as of January 2011

EN 60747-5-2-approved with option V4 or D4

For the latest information, please contact your nearest Toshiba sales representative.

4 Selection Guide

Photocouplers for Logic Signal Transmission at 10 Mbit/s (Typ.) (Continued)

Part Number	Pin Configuration	Features	Propagation Delay Time (Max)	Output Form	IFHL, IFLH (Max)	BVs	Safety Standards ⁽²⁾				
							UL/cUL	TÜV	VDE	BSI	IEC
TLP2630		DIP8 Dual-channel version of the 6N137 and the TLP552 V _{CC} = 5 V	75 ns (Topr = 25°C)	Open-collector	5 mA	2500 Vrms	○/○				
TLP2631		DIP8 High CMR Dual-channel version of the TLP554 V _{CC} = 5 V	75 ns (Topr = 25°C)	Open-collector	5 mA	2500 Vrms	○/○				

Photocouplers for Logic Signal Transmission at 5 Mbit/s (Typ.)

Part Number	Pin Configuration	Features	Propagation Delay Time (Max)	Output Form	IFHL, IFLH (Max)	BVs	Safety Standards ⁽²⁾				
							UL/cUL	TÜV	VDE	BSI	IEC
TLP105		Mini-flat MFSOP6 V _{CC} = 4.5 to 20 V Low input operation IPM drive	250 ns	Totem pole output (Buffer logic)	1.6 mA	3750 Vrms	○/○	○ ⁽¹⁾	○ ⁽¹⁾		
TLP108		Mini-flat MFSOP6 V _{CC} = 4.5 to 20 V Low input operation IPM drive	250 ns	Totem pole output (Inverter logic)	1.6 mA	3750 Vrms	○/○	○ ⁽¹⁾	○ ⁽¹⁾		
TLP2405		SO8 V _{CC} = 4.5 to 20 V Low input operation IPM drive	250 ns	Totem pole output (Buffer logic)	1.6 mA	3750 Vrms	○/○		○ ⁽¹⁾		
TLP2408		SO8 V _{CC} = 4.5 to 20 V Low input operation IPM drive	250 ns	Totem pole output (Inverter logic)	1.6 mA	3750 Vrms	○/○		○ ⁽¹⁾		
TLP555		DIP8 Low input current V _{CC} = 4.5 to 20 V	400 ns (Topr = 25°C)	3-state (Buffer logic)	1.6 mA	2500 Vrms	○/○				
TLP558		DIP8 Inverting logic version of the TLP555 V _{CC} = 4.5 to 20 V	400 ns (Topr = 25°C)	3-state (Inverter logic)	1.6 mA	2500 Vrms	○/○				
TLP715 TLP715F		SDIP6 IPM drive High CMR V _{CC} = 4.5 to 20 V	250 ns	Totem pole output (Buffer logic)	3 mA	5000 Vrms	○/○	○	○		
TLP718 TLP718F		SDIP6 IPM drive High CMR V _{CC} = 4.5 to 20 V	250 ns	Totem pole output (Inverter logic)	3 mA	5000 Vrms	○/○	○	○		
TLP2095		Mini-flat MFSOP6 Dual polarity input version of the TLP105 V _{CC} = 3 to 20 V	250 ns	Totem pole output (Buffer logic)	3 mA	3750 Vrms	○/○		○ ⁽¹⁾		
TLP2098		Mini-flat MFSOP6 Dual polarity input version of the TLP108 V _{CC} = 3 to 20 V	250 ns	Totem pole output (Inverter logic)	3 mA	3750 Vrms	○/○		○ ⁽¹⁾		

Note 1: The EN60747-5-2 safety standard for compact packages is different from that for standard DIP packages.

Since the mini-flat package is a compact package, please contact your nearest Toshiba sales representative for more details.

Note 2: BSI and IEC: ○: Approved (supplementary or basic insulation) ◎: Approved (reinforced insulation) △: Design which meets safety standard/approval pending as of January 2011
EN 60065- and IEC 60065-approved, EN 60950- and IEC 60950-approved

TÜV and VDE: ○: Approved △: Design which meets safety standard/approval pending as of January 2011
EN 60747-5-2-approved with option V4 or D4

For the latest information, please contact your nearest Toshiba sales representative.

Photocouplers for Logic Signal Transmission at 5 Mbit/s (Typ.) (Continued)

Part Number	Pin Configuration	Features	Propagation Delay Time (Max)	Output Form	IFHL, IFLH (Max)	BVs	Safety Standards ⁽²⁾				
							UL/cUL	TÜV	VDE	BSI	IEC
TLP2105		SO8 Dual-channel version for the TLP105 V _{CC} = 4.5 to 20 V	250 ns	Totem pole output (Buffer logic)	1.6 mA	3750 Vrms	○/○	○ ⁽¹⁾	○ ⁽¹⁾		
TLP2108		SO8 Dual-channel version for the TLP108 V _{CC} = 4.5 to 20 V	250 ns	Totem pole output (Inverter logic)	1.6 mA	3750 Vrms	○/○	○ ⁽¹⁾	○ ⁽¹⁾		
TLP2200		DIP8 Low input current V _{CC} = 4.5 to 20 V	400 ns	3-state (Buffer logic)	1.6 mA	2500 Vrms	○/○				

Photocouplers for Logic Signal Transmission at 1 Mbit/s (Typ.)

Part Number	Pin Configuration	Features	Data Rate (NRZ) (Typ.)	CTR	@IF	BVs	Safety Standards ⁽²⁾				
							UL/cUL	TÜV	VDE	BSI	IEC
TLP109		SO6 (reinforced insulation)	1 Mbit/s	20% (min)	16 mA	3750 Vrms	○/○		○ ⁽¹⁾		
TLP2409		SO8 T _{opr} = 125°C (max) SO8 version of the TLP109	1 Mbit/s	20% (min)	16 mA	3750 Vrms	○/○		○ ⁽¹⁾		
TLP512		DIP6 6-pin package version of the TLP550	1 Mbit/s	20% (min)	16 mA	2500 Vrms	○/-				
TLP550		DIP8 High CMR	1 Mbit/s	10% (min) (19% min for rank 0)	16 mA	2500 Vrms	○/○				
TLP551		DIP8 Internal base connection	1 Mbit/s	10% (min) (19% min for rank 0)	16 mA	2500 Vrms	○/○				
TLP2403		SO8 Low input current SO8 version of the TLP553	300 kbit/s	400% (min)	0.5 mA	3750 Vrms	○/○		○ ⁽¹⁾		
TLP553		DIP8 Low input drive current	300 kbit/s	400% (min)	0.5 mA	2500 Vrms	○/-				
TLP559		DIP8 High CMR version of the TLP550	1 Mbit/s	20% (min)	16 mA	2500 Vrms	○/○				
TLP651		DIP8 Internal base connection	1 Mbit/s	10% (min) (19% min for rank 0)	16 mA	5000 Vrms	○/○				
TLP719 TLP719F		SDIP6 High CMR	1 Mbit/s	20% (min)	16 mA	5000 Vrms	○/○	○	○		

Note 1: The EN60747-5-2 safety standard for compact packages is different from that for standard DIP packages.

Since the mini-flat package is a compact package, please contact your nearest Toshiba sales representative for more details.

Note 2: BSI and IEC: ○: Approved (supplementary or basic insulation) ◎: Approved (reinforced insulation) △: Design which meets safety standard/approval pending as of January 2011

EN 60065- and IEC 60065-approved, EN 60950- and IEC 60950-approved

TÜV and VDE: ○: Approved △: Design which meets safety standard/approval pending as of January 2011

EN 60747-5-2-approved with option V4 or D4

For the latest information, please contact your nearest Toshiba sales representative.

4 Selection Guide

Photocouplers for Logic Signal Transmission at 1 Mbit/s (Typ.) (Continued)

Part Number	Pin Configuration	Features	Data Rate (NRZ) (Typ.)	CTR	@IF	BVs	Safety Standards ⁽²⁾				
							UL/cUL	TÜV	VDE	BSI	IEC
TLP750 TLP750F		DIP8 High CMR SEMKO-approved	1 Mbit/s	10% (min) (19% min for rank 0)	16 mA	5000 Vrms	○/○	△	○	◎	◎
TLP751 TLP751F		DIP8 Internal base connection SEMKO-approved	1 Mbit/s	10% (min)	16 mA	5000 Vrms	○/○	△	○	◎	◎
TLP759 TLP759F		DIP8 IEC60950-compliant version of the TLP559 SEMKO-approved	1 Mbit/s	20% (min)	16 mA	5000 Vrms	○/○	△	○	◎	◎
TLP2530		DIP8 Dual-channel version of the 6N135 and the TLP550	1 Mbit/s	7% (min)	16 mA	2500 Vrms	○/○				
TLP2531		DIP8 Dual-channel version of the 6N136 and the TLP550	1 Mbit/s	19% (min)	16 mA	2500 Vrms	○/○				

IPM-Drive Photocouplers

Part Number	Pin Configuration	Features	Propagation Delay Time (Max)	Output Form/CTR	IFHL, IFLH (Max)	BVs	Safety Standards ⁽²⁾				
							UL/cUL	TÜV	VDE	BSI	IEC
TLP104		SO6 (reinforced insulation) IPM drive T _{opr} = 125°C (max)	550 ns	Open-collector	5 mA	3750 Vrms	○/○		○ ⁽¹⁾		
TLP2404		SO8 IPM drive T _{opr} = 125°C (max) SO8 version of the TLP104	550 ns	Open-collector (Inverter logic)	5 mA	3750 Vrms	○/○		○ ⁽¹⁾		
TLP714 TLP714F		SDIP6 (reinforced insulation) IPM drive T _{opr} = 125°C (max) High isolation voltage	550 ns	Open-collector (Inverter logic)	5 mA	5000 Vrms	○/○		○		
TLP754* TLP754F*		DIP8 IPM drive	550 ns	Open-collector	5 mA	5000 Vrms	△/△		△		
TLP109(IGM)		SO6 (reinforced insulation) IPM drive High CMR	800 ns	25% (min)	10 mA	3750 Vrms	○/○		○ ⁽¹⁾		
TLP2409(IGM)		SO8 IPM drive High CMR	800 ns	20% (min)	10 mA	3750 Vrms	△/△		△ ⁽¹⁾		

*Under development. Specifications subject to change without notice. For the latest information, please contact your nearest Toshiba sales representative.

Note 1: The EN60747-5-2 safety standard for compact packages is different from that for standard DIP packages.

Since the mini-flat package is a compact package, please contact your nearest Toshiba sales representative for more details.

Note 2: BSI and IEC: ○: Approved (supplementary or basic insulation) ◎: Approved (reinforced insulation) △: Design which meets safety standard/approval pending as of January 2011
EN 60065- and IEC 60065-approved, EN 60950- and IEC 60950-approved

TÜV and VDE: ○: Approved △: Design which meets safety standard/approval pending as of January 2011

EN 60747-5-2-approved with option V4 or D4

For the latest information, please contact your nearest Toshiba sales representative.

IPM-Drive Photocouplers (Continued)

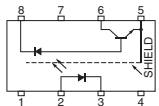
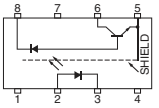

Part Number	Pin Configuration	Features	Propagation Delay Time (Max)	Output Form/CTR	I _{FHL} , I _{FLH} (Max)	BV _s	Safety Standards ⁽²⁾				
							UL/cUL	TÜV	VDE	BSI	IEC
TLP559(IGM)		DIP8 IPM drive High CMR	800 ns	25% (min)	10 mA	2500 Vrms	○/○				
TLP759(IGM) TLP759F(IGM)		DIP8 IPM drive High CMR SEMKO-approved	800 ns	25% (min)	10 mA	5000 Vrms	○/○	△	○	◎	◎

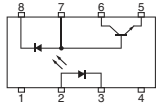
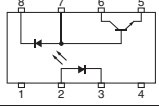
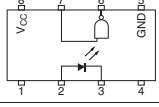
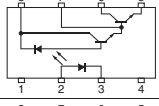
JEDEC-Compliant Photocouplers

Part Number	Pin Configuration	Features	Data Rate (NRZ) (Typ.)	CTR	I _{FHL} , I _{FLH} (Max)	BV _s	Safety Standards ⁽²⁾				
							UL/cUL	TÜV	VDE	BSI	IEC
6N135		JEDEC-compliant	1 Mbit/s	7% (min)	16 mA	2500 Vrms	○/—				
6N136		JEDEC-compliant	1 Mbit/s	19% (min)	16 mA	2500 Vrms	○/—				
6N137		JEDEC-compliant	10 Mbit/s	700% (Typ.)	5 mA	2500 Vrms	○/—				
6N138		JEDEC-compliant High CTR	300 kbit/s	300% (min)	1.6 mA	2500 Vrms	○/—				
6N139		JEDEC-compliant High CTR	300 kbit/s	400% (min)	0.5 mA	2500 Vrms	○/—				

Note 2: BSI and IEC: ○: Approved (supplementary or basic insulation) ◎: Approved (reinforced insulation) △: Design which meets safety standard/approval pending as of January 2011
 EN 60065- and IEC 60065-approved, EN 60950- and IEC 60950-approved
 TÜV and VDE: ○: Approved △: Design which meets safety standard/approval pending as of January 2011
 EN 60747-5-2-approved with option V4 or D4
 For the latest information, please contact your nearest Toshiba sales representative.

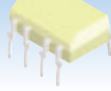
3 Photocouplers for IGBT/MOSFET Gate Drive

Package Output Peak Current				
	SDIP6	DIP8	SO6	SO8
± 0.25 A		TLP557		
± 0.45 A (max)	TLP705 (High speed)			
± 0.6 A (max)	TLP701 TLP701A* TLP701H* TLP705A*	TLP351 TLP351A* TLP351E TLP351H*	TLP151* TLP151A* TLP155E	TLP2451 TLP2451A*
± 2.0 A (max)	TLP700 TLP700H*			
± 2.5 A (max)		TLP350 TLP350H* TLP352*		

*Under development. Specifications subject to change without notice. For the latest information, please contact your nearest Toshiba sales representative.

4 Selection Guide

Photocouplers for IGBT/MOSFET Gate Drive

Part Number	Pin Configuration	Features	Propagation Delay Time (Max)	Output	I _{FHL} (Max)	BV _s	Safety Standards ⁽²⁾				
							UL/cUL	TÜV	VDE	BSI	IEC
TLP151*		SO6 (reinforced Insulation) T _{opr} = 110°C (max) Direct drive of a small-power IGBT/MOSFET	0.7 μs	Peak output current (max): ±0.6 A	5 mA	3750 Vrms	○/○		○ ⁽¹⁾		
TLP151A*			0.5 μs				○/○		△ ⁽¹⁾		
TLP155E		SO6 (reinforced Insulation) T _{opr} = 100°C (max) Direct drive of a small-power IGBT/MOSFET	0.2 μs	Peak output current (max): ±0.6 A	7.5 mA	3750 Vrms	○/○		○		
TLP2451		SO8 T _{opr} = 125°C (max) Direct drive of a small-power IGBT/MOSFET High CMR	0.7 μs	Peak output current (max): ±0.6 A	5 mA	3750 Vrms	○/○		○		
TLP2451A*			0.5 μs				○/○		△		
TLP350 TLP350F		DIP8 Direct drive of a medium-power IGBT/MOSFET High CMR Low power dissipation	0.5 μs	Peak output current (max): ±2.5 A	5 mA	3750 Vrms	○/○	○	○		
TLP350H* TLP350HF*		DIP8 T _{opr} = 125°C (max) Direct drive of a medium-power IGBT/MOSFET High CMR	0.5 μs	Peak output current (max): ±2.5 A	5 mA	3750 Vrms	○/○		○		
TLP351 TLP351F		DIP8 Direct drive of a medium-power IGBT/MOSFET Low power dissipation	0.7 μs	Peak output current (max): ±0.6 A	5 mA	3750 Vrms	○/○	○	○		
TLP351A* TLP351AF*		DIP8 Direct drive of a small-power IGBT/MOSFET Low power dissipation	0.7 μs	Peak output current (max): ±0.6 A	5 mA	3750 Vrms	△/△				
TLP351H* TLP351HF*		DIP8 T _{opr} = 125°C (max) Direct drive of a small-power IGBT/MOSFET High CMR	0.7 μs	Peak output current (max): ±6.0 A	5 mA	3750 Vrms	○/○		○		
TLP352* TLP352F*		DIP8 Direct drive of a medium-power IGBT/MOSFET Low power dissipation T _{opr} = 125°C (max)	0.2 μs	Peak output current (max): ±2.5 A	5 mA	3750 Vrms	△/△				

*Under development. Specifications subject to change without notice. For the latest information, please contact your nearest Toshiba sales representative.

Note 1: The EN60747-5-2 safety standard for compact packages is different from that for standard DIP packages.

Since the mini-flat package is a compact package, please contact your nearest Toshiba sales representative for more details.

Note 2: BSI and IEC: ○: Approved (supplementary or basic insulation) ◎: Approved (reinforced insulation) △: Design which meets safety standard/approval pending as of January 2011

EN 60065- and IEC 60065-approved, EN 60950- and IEC 60950-approved

TÜV and VDE: ○: Approved △: Design which meets safety standard/approval pending as of January 2011

EN 60747-5-2-approved with option V4 or D4

For the latest information, please contact your nearest Toshiba sales representative.

Photocouplers for IGBT/MOSFET Gate Drive (Continued)

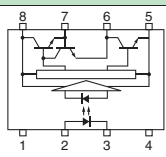
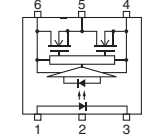
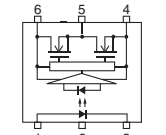
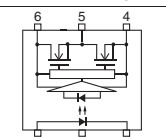
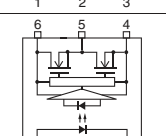
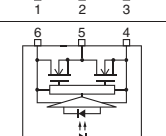
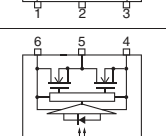
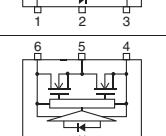
Part Number	Pin Configuration	Features	Propagation Delay Time (Max)	Output	I _{FHL} (Max)	BV _s	Safety Standards ⁽²⁾				
							UL/cUL	TÜV	VDE	BSI	IEC
TLP557		DIP8 Direct drive of a power transistor	5 μs	Constant current output : 0.25 A	5 mA	2500 Vrms	○/○				
TLP700 TLP700F		SDIP6 Direct drive of a medium-power IGBT/MOSFET Low power dissipation	0.5 μs	Peak output current (max): ±2.0 A	5 mA	5000 Vrms	○/○	○	△		
TLP700H* TLP700HF*		SDIP6 T _{opr} = 125°C (max) Direct drive of a medium-power IGBT/MOSFET High CMR	0.5 μs	Peak output current (max): ±2.0 A	5 mA	5000 Vrms	○/○		○		
TLP701 TLP701F		SDIP6 Direct drive of a medium-power IGBT/MOSFET Low power dissipation	0.7 μs	Peak output current (max): ±0.6 A	5 mA	5000 Vrms	○/○	○	○		
TLP701A* TLP701AF*		SDIP6 Direct drive of a small-power IGBT/MOSFET Low power dissipation	0.7 μs	Peak output current (max): ±0.6 A	5 mA	5000 Vrms	○/○		○		
TLP701H* TLP701HF*		SDIP6 T _{opr} = 125°C (max) Direct drive of a small-power IGBT/MOSFET High CMR	0.7 μs	Peak output current (max): ±0.6 A	5 mA	5000 Vrms	○/○		○		
TLP705 TLP705F		SDIP6 Direct drive of a small-power IGBT/MOSFET High speed (250 kHz) Low power dissipation	0.2 μs	Peak output current (max): ±0.45 A	8 mA	5000 Vrms	○/○	○	○		
TLP705A* TLP705AF*		SDIP6 Direct drive of a small-power IGBT/MOSFET High speed Low power dissipation	0.2 μs	Peak output current (max): ±0.6 A	7.5 mA	5000 Vrms	○/○		○		

*Under development. Specifications subject to change without notice. For the latest information, please contact your nearest Toshiba sales representative.

Note 1: The EN60747-5-2 safety standard for compact packages is different from that for standard DIP packages.

Since the mini-flat package is a compact package, please contact your nearest Toshiba sales representative for more details.

Note 2: BSI and IEC: ○: Approved (supplementary or basic insulation) ◎: Approved (reinforced insulation) △: Design which meets safety standard/approval pending as of January 2011

EN 60065- and IEC 60065-approved, EN 60950- and IEC 60950-approved









TÜV and VDE: ○: Approved △: Design which meets safety standard/approval pending as of January 2011

EN 60747-5-2-approved with option V4 or D4

For the latest information, please contact your nearest Toshiba sales representative.

4 Selection Guide

4 Photorelays (1-Form-A and 2-Form-A)

Features			Package								
Off-State Voltage (max) (V)	On-State Resistance (max) (Ω)	On-State Current (max) (A)									
			USOP4	SSOP4	SO6	2.54SOP4	2.54SOP6	2.54SOP8	DIP4	DIP6	DIP8
20	8	0.16		TLP3230		TLP3130					
	5	0.2		TLP3250							
	1.2	0.3				TLP3131					
	1.2	0.45		TLP3231							
	0.22	0.9		TLP3203							
	0.05	2.5					TLP3100				
40	0.05	4								TLP3543*	
	35	0.08		TLP3213		TLP3113					
	15	0.12		TLP3216		TLP3116					
	14	0.12		TLP3240							
	10	0.14		TLP3241							
	3	0.25		TLP3214		TLP3114					
	1.5	0.3		TLP3215		TLP3115					
	0.13	1				TLP3123					
50	0.06	2.5					TLP3102				
	0.06	3.5								TLP3544*	
50	1.5	0.3	TLP3375	TLP3275							
60	50	0.07				TLP173A [†]					
	50	0.1			TLP175A*						
	2	0.4				TLP170A TLP172A TLP176A	TLP192A TLP197A	TLP202A* TLP206A*			
	2	0.5							TLP220A* TLP222A TLP227A	TLP598AA TLP592A TLP597A	TLP222A-2* TLP227A-2*
	1.5	0.4		TLP3212							
	1.2	0.35				TLP3110					
	1.1	0.5							TLP225A		
	1	0.4	TLP3312								
	0.7	1				TLP3122					
	0.2	1.5							TLP221A*		
	0.1	2.5								TLP3542	
0.07	2.3						TLP3103				
0.07	3									TLP3545*	
80	25	0.04		TLP3218		TLP3118 TLP3111					
	20	0.1									
	12	0.12		TLP3217							
	8	0.2		TLP3219		TLP3119 TLP3121					
	1.2	0.35									
100	0.15	1.25					TLP3120				
	14	0.08		TLP3220							
	0.2	1.4					TLP3105				
200	0.2	2									TLP3546*
	50	0.05				TLP179D TLP170D TLP176D	TLP199D TLP197D	TLP209D* TLP200D*			
	8	0.2									
350	8	0.25							TLP220D*		
	50	0.1				TLP170G			TLP220G*		
	35	0.11				TLP172G	TLP192G	TLP202G*			
400	35	0.12				TLP174G TLP176G	TLP197G	TLP206G*	TLP222G TLP224G TLP227G	TLP592G TLP597G	TLP222G-2* TLP224G-2* TLP227G-2*
	35	0.12				TLP176GA	TLP197GA	TLP206GA*	TLP227GA TLP220GA*	TLP597GA TLP797GA	TLP227GA-2*
	12	0.15								TLP598GA TLP798GA	
600	35	0.12				TLP174GA			TLP224GA		TLP224GA-2*
	4	0.2						TLP3125			
	35	0.1								TLP797J	
60	0.09				TLP170J			TLP220J*			

*Under development. Specifications subject to change without notice. For the latest information, please contact your nearest Toshiba sales representative.

* Dual-channel †: MFSOP6

MOSFET-Output Photorelays, 1-Form-A in a USOP4 Package

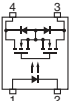
Part Number	Pin Configuration	Features	IFT (Max)	RON (Max)		ION (Max)	VOFF	BVVs	Safety Standards ⁽²⁾				
					@IF				UL/cUL	TÜV	VDE	BSI	IEC
TLP3312*		USOP4 COFF: 20 pF (typ.)	3 mA	1 Ω	5 mA	0.4 A	60 V	500 Vrms					
TLP3375*		USOP4 COFF: 12 pF (typ.)	3 mA	1.5 Ω	5 mA	0.3 A	50 V	500 Vrms					

MOSFET-Output Photorelays, 1-Form-A in a SO6 Package

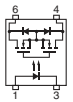
Part Number	Pin Configuration	Features	IFT (Max)	RON (Max)		ION (Max)	VOFF	BVVs	Safety Standards ⁽²⁾				
					@IF				UL/cUL	TÜV	VDE	BSI	IEC
TLP175A*		SO6 General-purpose Low trigger current	1 mA	50 Ω	2 mA	0.1 A	60 V	3750 Vrms	Δ / Δ				

MOSFET-Output Photorelays, 1-Form-A in a SSOP4 Package

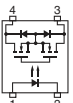
Part Number	Pin Configuration	Features	IFT (Max)	RON (Max)		ION (Max)	VOFF	BVVs	Safety Standards ⁽²⁾				
					@IF				UL/cUL	TÜV	VDE	BSI	IEC
TLP3203		SSOP4 COFF: 40 pF (typ.)	3 mA	0.22 Ω	5 mA	0.9 A	20 V	1500 Vrms	○ / -				
TLP3212		SSOP4 COFF: 20 pF (typ.)	5 mA	1.5 Ω	5 mA	0.4 A	60 V	1500 Vrms	○ / -				
TLP3213		SSOP4 COFF: 0.6 pF (typ.)	4 mA	35 Ω	5 mA	0.08 A	40 V	1500 Vrms	○ / -				
TLP3214		SSOP4 COFF: 5 pF (typ.)	4 mA	3 Ω	5 mA	0.25 A	40 V	1500 Vrms	○ / -				
TLP3215		SSOP4 COFF: 10 pF (typ.)	4 mA	1.5 Ω	5 mA	0.3 A	40 V	1500 Vrms	○ / -				
TLP3216		SSOP4 COFF: 1 pF (typ.)	4 mA	15 Ω	5 mA	0.12 A	40 V	1500 Vrms	○ / -				
TLP3217		SSOP4 COFF: 5 pF (typ.)	5 mA	12 Ω	10 mA	0.12 A	80 V	1500 Vrms	○ / -				
TLP3218		SSOP4 COFF: 2.5 pF (typ.)	5 mA	25 Ω	5 mA	0.04 A	80 V	1500 Vrms	Δ / -				
TLP3219		SSOP4 COFF: 6.5 pF (typ.)	3 mA	8 Ω	5 mA	0.2 A	80 V	1500 Vrms	Δ / -				
TLP3220		SSOP4 COFF: 6 pF (typ.)	5 mA	14 Ω	10 mA	0.08 A	100 V	1500 Vrms	○ / -				
TLP3230		SSOP4 COFF: 1 pF (typ.)	4 mA	8 Ω	5 mA	0.16 A	20 V	1500 Vrms	○ / -				
TLP3231		SSOP4 COFF: 5 pF (typ.)	4 mA	1.2 Ω	5 mA	0.45 A	20 V	1500 Vrms	○ / -				
TLP3240		SSOP4 COFF: 0.45 pF (typ.)	3 mA	14 Ω	5 mA	0.12 A	40 V	1500 Vrms	○ / -				
TLP3241		SSOP4 COFF: 0.7 pF (typ.)	3 mA	10 Ω	5 mA	0.14 A	40 V	1500 Vrms	○ / -				
TLP3250		SSOP4 COFF: 0.8 pF (typ.)	3 mA	5 Ω	5 mA	0.2 A	20 V	1500 Vrms	○ / -				
TLP3275		SSOP4 COFF: 12 pF (typ.)	3 mA	1.5 Ω	5 mA	0.3 A	50 V	1500 Vrms	○ / -				

*Under development. Specifications subject to change without notice. For the latest information, please contact your nearest Toshiba sales representative.

Note 1: The EN60747-5-2 safety standard for compact packages is different from that for standard DIP packages.

Since the mini-flat package is a compact package, please contact your nearest Toshiba sales representative for more details.

Note 2: BSI and IEC: ○: Approved (supplementary or basic insulation) ◎: Approved (reinforced insulation) Δ: Design which meets safety standard/approval pending as of January 2011
EN 60065- and IEC 60065-approved, EN 60950- and IEC 60950-approved

TÜV and VDE: ○: Approved Δ: Design which meets safety standard/approval pending as of January 2011

EN 60747-5-2-approved with option V4 or D4

For the latest information, please contact your nearest Toshiba sales representative.

4 Selection Guide

MOSFET-Output Photorelays, 1-Form-A in a 2.54SOP4 Package

Part Number	Pin Configuration	Features	IFT (Max)	RON (Max)		ION (Max)	VOFF	BVVs	Safety Standards ⁽²⁾				
					@IF				UL/cUL	TÜV	VDE	BSI	IEC
TLP170A		2.54SOP4 Lead pitch: 2.54 mm Low trigger LED current	1 mA	2 Ω	2 mA	0.4 A	60 V	1500 Vrms	○/○				
TLP170D		2.54SOP4 Lead pitch: 2.54 mm Low trigger LED current	1 mA	8 Ω	2 mA	0.2 A	200 V	1500 Vrms	○/○				
TLP170G		2.54SOP4 Lead pitch: 2.54 mm Low trigger LED current	1 mA	50 Ω	2 mA	0.1 A	350 V	1500 Vrms	○/○				
TLP170J		2.54SOP4 Lead pitch: 2.54 mm Low trigger LED current	1 mA	60 Ω	2 mA	0.09 A	600 V	1500 Vrms	○/○				
TLP172A		2.54SOP4 Lead pitch: 2.54 mm COFF: 130 pF (typ.)	3 mA	2 Ω	5 mA	0.4 A	60 V	1500 Vrms	○/○				
TLP172G		2.54SOP4 Lead pitch: 2.54 mm COFF: 30 pF (typ.)	3 mA	35 Ω	5 mA	0.11 A	350 V	1500 Vrms	○/○				
TLP173A		Mini-flat MFSOP6 Low trigger LED current	2 mA	50 Ω	3 mA	0.07 A	60 V	3750 Vrms	○/○	△	△		
TLP174G		2.54SOP4 Lead pitch: 2.54 mm SEMKO-approved Current-limiting function Limit current: 150 to 300 mA	3 mA	35 Ω	5 mA	0.12 A	350 V	1500 Vrms	○/○				△
TLP174GA		2.54SOP4 Lead pitch: 2.54 mm Current-limiting function Limit current: 150 to 300 mA	3 mA	35 Ω	5 mA	0.12 A	400 V	1500 Vrms	○/○				
TLP176A		2.54SOP4 Lead pitch: 2.54 mm COFF: 130 pF (typ.)	3 mA	2 Ω	5 mA	0.4 A	60 V	1500 Vrms	○/○	△	○ ⁽¹⁾		
TLP176D		2.54SOP4 Lead pitch: 2.54 mm COFF: 100 pF (typ.)	3 mA	8 Ω	5 mA	0.2 A	200 V	1500 Vrms	○/○	△	○ ⁽¹⁾		
TLP176G		2.54SOP4 Lead pitch: 2.54 mm SEMKO-approved COFF: 40 pF (typ.)	3 mA	35 Ω	5 mA	0.12 A	350 V	1500 Vrms	○/○	△	○ ⁽¹⁾	○	○
TLP176GA		2.54SOP4 Lead pitch: 2.54 mm COFF: 70 pF (typ.)	3 mA	35 Ω	5 mA	0.12 A	400 V	1500 Vrms	○/○			○	○
TLP179D		2.54SOP4 Lead pitch: 2.54 mm COFF: 15 pF (typ.)	3 mA	50 Ω	5 mA	0.05 A	200 V	1500 Vrms	○/○				
TLP3110		2.54SOP4 Lead pitch: 2.54 mm COFF: 100 pF (typ.)	4 mA	1.2 Ω	5 mA	0.35 A	60 V	1500 Vrms	○/—				
TLP3111		2.54SOP4 Lead pitch: 2.54 mm COFF: 11 pF (typ.)	4 mA	20 Ω	5 mA	0.1 A	80 V	1500 Vrms	○/—				
TLP3113		2.54SOP4 Lead pitch: 2.54 mm COFF: 0.6 pF (typ.)	4 mA	35 Ω	5 mA	0.08 A	40 V	1500 Vrms	○/—				
TLP3114		2.54SOP4 Lead pitch: 2.54 mm COFF: 5 pF (typ.)	4 mA	3 Ω	5 mA	0.25 A	40 V	1500 Vrms	○/—				
TLP3115		2.54SOP4 Lead pitch: 2.54 mm COFF: 10 pF (typ.)	4 mA	1.5 Ω	5 mA	0.3 A	40 V	1500 Vrms	○/—				
TLP3116		2.54SOP4 Lead pitch: 2.54 mm COFF: 1 pF (typ.)	4 mA	15 Ω	5 mA	0.12 A	40 V	1500 Vrms	○/—				
TLP3118		2.54SOP4 Lead pitch: 2.54 mm COFF: 2.5 pF (typ.)	3 mA	25 Ω	5 mA	0.04 A	80 V	1500 Vrms	○/—				

Note 1: The EN60747-5-2 safety standard for compact packages is different from that for standard DIP packages.

Since the mini-flat package is a compact package, please contact your nearest Toshiba sales representative for more details.

Note 2: BSI and IEC: ○: Approved (supplementary or basic insulation) ◎: Approved (reinforced insulation) △: Design which meets safety standard/approval pending as of January 2011

EN 60065- and IEC 60065-approved, EN 60950- and IEC 60950-approved

TÜV and VDE: ○: Approved △: Design which meets safety standard/approval pending as of January 2011

EN 60747-5-2-approved with option V4 or D4

For the latest information, please contact your nearest Toshiba sales representative.

MOSFET-Output Photorelays, 1-Form-A in a 2.54SOP4 Package (Continued)

Part Number	Pin Configuration	Features	IFT (Max)	RON (Max)		ION (Max)	VOFF	BVs	Safety Standards ⁽²⁾				
					@IF				UL/cUL	TÜV	VDE	BSI	IEC
TLP3119		2.54SOP4 Lead pitch: 2.54 mm COFF: 6.5 pF (typ.)	3 mA	8 Ω	5 mA	0.2 A	80 V	1500 Vrms	○/–				
TLP3121		2.54SOP4 Lead pitch: 2.54 mm COFF: 30 pF (typ.)	4 mA	1.2 Ω	5 mA	0.35 A	80 V	1500 Vrms	○/○				
TLP3122		2.54SOP4 Lead pitch: 2.54 mm ION: 1 A (max) @ Ta: up to 50°C COFF: 90 pF (typ.)	3 mA	0.7 Ω	5 mA	1.0 A	60 V	1500 Vrms	○/○				
TLP3123		2.54SOP4 Lead pitch: 2.54 mm ION: 1 A (max) @ Ta: up to 50°C COFF: 300 pF (typ.)	3 mA	0.13 Ω	5 mA	1.0 A	40 V	1500 Vrms	○/○				
TLP3130		2.54SOP4 Lead pitch: 2.54 mm COFF: 1 pF (typ.)	4 mA	8 Ω	5 mA	0.16 A	20 V	1500 Vrms	○/–				
TLP3131		2.54SOP4 Lead pitch: 2.54 mm COFF: 5 pF (typ.)	4 mA	1.2 Ω	5 mA	0.3 A	20 V	1500 Vrms	○/–				

MOSFET-Output Photorelays, 1-Form-A in a 2.54SOP6 or 2.54SOP8 Package

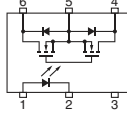
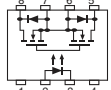
Part Number	Pin Configuration	Features	IFT (Max)	RON (Max)		ION (Max)	VOFF	BVs	Safety Standards ⁽²⁾					
					@IF				UL/cUL	TÜV	VDE	BSI	IEC	
TLP192A		2.54SOP6 Lead pitch: 2.54 mm COFF: 130 pF (typ.)	3 mA	2 Ω	5 mA	0.4 A	60 V	1500 Vrms	○/○					
TLP192G		2.54SOP6 Lead pitch: 2.54 mm COFF: 30 pF (typ.)	3 mA	35 Ω	5 mA	0.11 A	350 V	1500 Vrms	○/○					
TLP197A		2.54SOP6 Lead pitch: 2.54 mm COFF: 130 pF (typ.)	3 mA	2 Ω	5 mA	0.4 A	60 V	1500 Vrms	○/○					
TLP197D		2.54SOP6 Lead pitch: 2.54 mm COFF: 100 pF (typ.)	3 mA	8 Ω	5 mA	0.2 A	200 V	1500 Vrms	○/○					
TLP197G		2.54SOP6 Lead pitch: 2.54 mm SEMKO-approved	3 mA	35 Ω	5 mA	0.12 A	350 V	1500 Vrms	○/○	△	○ ⁽¹⁾	○	○	
TLP197GA		2.54SOP6 Lead pitch: 2.54 mm COFF: 70 pF (typ.)	3 mA	35 Ω	5 mA	0.12 A	400 V	1500 Vrms	○/–			○	○	
TLP199D		2.54SOP6 Lead pitch: 2.54 mm COFF: 15 pF (typ.)	3 mA	50 Ω	5 mA	0.05 A	200 V	1500 Vrms	○/○					
TLP3100		2.54SOP6 Lead pitch: 2.54 mm ION: 2.5 A (max) @ Ta: up to 50°C	3 mA	0.05 Ω	5 mA	2.5 A	20 V	1500 Vrms	○/○					
TLP3102		2.54SOP6 ION (DC) = 5 A (max); C-connection	3 mA	0.06 Ω	5 mA	2.5 A	40 V	1500 Vrms	△/△					
TLP3103		2.54SOP6 ION (DC) = 4.6 A (max); C-connection	3 mA	0.07 Ω	5 mA	2.3 A	60 V	1500 Vrms	△/△					
TLP3105		2.54SOP6 ION (DC) = 2.8 A (max); C-connection	3 mA	0.2 Ω	5 mA	1.4 A	100 V	1500 Vrms	△/△					
TLP3120		2.54SOP6 Lead pitch: 2.54 mm ION: 1.25 A (max)	5 mA	0.15 Ω	5 mA	1.25 A	80 V	1500 Vrms	○/○					
TLP3125			2.54SOP8 Lead pitch: 2.54 mm COFF: 410 pF (typ.)	3 mA	4 Ω	5 mA	0.2 A	400 V	1500 Vrms	○/○				

Note 1: The EN60747-5-2 safety standard for compact packages is different from that for standard DIP packages.

Since the mini-flat package is a compact package, please contact your nearest Toshiba sales representative for more details.

Note 2: BSI and IEC: ○: Approved (supplementary or basic insulation) ◎: Approved (reinforced insulation) △: Design which meets safety standard/approval pending as of January 2011

EN 60065- and IEC 60065-approved, EN 60950- and IEC 60950-approved

TÜV and VDE: ○: Approved △: Design which meets safety standard/approval pending as of January 2011

EN 60747-5-2-approved with option V4 or D4

For the latest information, please contact your nearest Toshiba sales representative.

4 Selection Guide

MOSFET-Output Photorelays, 2-Form-A in a 2.54SOP8 Package

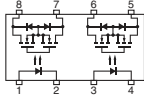
Part Number	Pin Configuration	Features	IFT (Max)	RON (Max)		ION (Max)	VOFF	BVs	Safety Standards (2)				
					@IF				UL/cUL	TÜV	VDE	BSI	IEC
TLP200D		2.54SOP8 Lead pitch: 2.54 mm Dual-channel version of the TLP176D	3 mA	8 Ω	5 mA	0.2 A	200 V	1500 Vrms	○/—				
TLP202A		2.54SOP8 Lead pitch: 2.54 mm Dual-channel version of the TLP172A	3 mA	2 Ω	5 mA	0.4 A	60 V	1500 Vrms	○/—				
TLP202G		2.54SOP8 Lead pitch: 2.54 mm Dual-channel version of the TLP172G	3 mA	50 Ω	5 mA	0.11 A	350 V	1500 Vrms	○/—				
TLP206A		2.54SOP8 Lead pitch: 2.54 mm Dual-channel version of the TLP176A	3 mA	2 Ω	5 mA	0.4 A	60 V	1500 Vrms	○/—				
TLP206G		2.54SOP8 Lead pitch: 2.54 mm Dual-channel version of the TLP176G	3 mA	35 Ω	5 mA	0.12 A	350 V	1500 Vrms	○/—	△	○ ⁽¹⁾	○	○
TLP206GA		2.54SOP8 Lead pitch: 2.54 mm Dual-channel version of the TLP176GA	3 mA	35 Ω	5 mA	0.12 A	400 V	1500 Vrms	○/—			○	○
TLP209D		2.54SOP8 Lead pitch: 2.54 mm Dual-channel version of the TLP179D	3 mA	50 Ω	5 mA	0.05 A	200 V	1500 Vrms	○/—				

MOSFET-Output Photorelays, 1-Form-A in a DIP4 Package

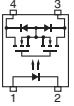
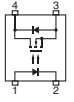
Part Number	Pin Configuration	Features	IFT (Max)	RON (Max)		ION (Max)	VOFF	BVs	Safety Standards (2)				
					@IF				UL/cUL	TÜV	VDE	BSI	IEC
TLP220A*		DIP4 General-purpose Reinforced insulation	2 mA	2 Ω	5 mA	±0.5 A	60 V	5000 Vrms	△/△		△	△	
TLP220D*		DIP4 General-purpose Reinforced insulation	2 mA	8 Ω	5 mA	±0.25 A	200 V	5000 Vrms	△/△		△	△	
TLP220G*		DIP4 General-purpose Reinforced insulation	2 mA	50 Ω	5 mA	±0.1 A	350 V	5000 Vrms	△/△		△	△	
TLP220GA*		DIP4 General-purpose Reinforced insulation	2 mA	35 Ω	5 mA	±0.12 A	400 V	5000 Vrms	△/△		△	△	
TLP220J*		DIP4 General-purpose Reinforced insulation	2 mA	60 Ω	5 mA	±0.09 A	600 V	5000 Vrms	△/△		△	△	
TLP221A*		DIP4 General-purpose Reinforced insulation	2 mA	0.2 Ω	5 mA	±1.5 A	60 V	5000 Vrms	△/△		△	△	
TLP222A		DIP4 COFF: 130 pF (typ.)	3 mA	2 Ω	5 mA	0.5 A	60 V	2500 Vrms	○/○				
TLP222G		DIP4 COFF: 30 pF (typ.)	3 mA	50 Ω	5 mA	0.12 A	350 V	2500 Vrms	○/○			○	○
TLP224G		DIP4 SEMKO-approved Current-limiting function Limit current: 150 to 300 mA	3 mA	35 Ω	5 mA	0.12 A	350 V	2500 Vrms	○/○			◎	◎
TLP224GA		DIP4 For modems Current-limiting function Limit current: 150 to 300 mA	3 mA	35 Ω	5 mA	0.12 A	400 V	2500 Vrms	○/—				△
TLP227A	DIP4 SEMKO-approved COFF: 130 pF (typ.)	3 mA	2 Ω	5 mA	0.5 A	60 V	2500 Vrms	○/○				△	
TLP227G	DIP4 SEMKO-approved COFF: 40 pF (typ.)	3 mA	35 Ω	5 mA	0.12 A	350 V	2500 Vrms	○/○	△	○	○	○	
TLP227GA	DIP4 SEMKO-approved	3 mA	35 Ω	5 mA	0.12 A	400 V	2500 Vrms	○/—				△	
TLP225A		DIP4 Designed for DC output modules	5 mA	1.1 Ω	10 mA	0.5 A	60 V	2500 Vrms	○/○				

*Under development. Specifications subject to change without notice. For the latest information, please contact your nearest Toshiba sales representative.

Note 1: The EN60747-5-2 safety standard for compact packages is different from that for standard DIP packages.

Since the mini-flat package is a compact package, please contact your nearest Toshiba sales representative for more details.

Note 2: BSI and IEC: ○: Approved (supplementary or basic insulation) ◎: Approved (reinforced insulation) △: Design which meets safety standard/approval pending as of January 2011
EN 60065- and IEC 60065-approved, EN 60950- and IEC 60950-approved

TÜV and VDE: ○: Approved △: Design which meets safety standard/approval pending as of January 2011

EN 60747-5-2-approved with option V4 or D4

For the latest information, please contact your nearest Toshiba sales representative.

MOSFET-Output Photorelays, 1-Form-A in a DIP6 Package

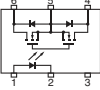
Part Number	Pin Configuration	Features	I _{FT} (Max)	R _{ON} (Max)		I _{ON} (Max)	V _{OFF}	BV _s	Safety Standards ⁽²⁾				
					@ I _F				UL/cUL	TÜV	VDE	BSI	IEC
TLP592A		DIP6 C _{OFF} : 130 pF (typ.)	3 mA	2 Ω	5 mA	0.5 A	60 V	2500 V _{rms}	○/—				
TLP592G		DIP6 C _{OFF} : 30 pF (typ.)	3 mA	50 Ω	5 mA	0.12 A	350 V	2500 V _{rms}	○/—				
TLP597A		DIP6 SEMKO-approved C _{OFF} : 130 pF (typ.)	3 mA	2 Ω	5 mA	0.5 A	60 V	2500 V _{rms}	○/—				△
TLP597G		DIP6 SEMKO-approved C _{OFF} : 40 pF (typ.)	3 mA	35 Ω	5 mA	0.12 A	350 V	2500 V _{rms}	○/—	△	○	○	○
TLP597GA		DIP6 SEMKO-approved C _{OFF} : 70 pF (typ.)	3 mA	35 Ω	5 mA	0.12 A	400 V	2500 V _{rms}	○/—				△
TLP598AA		DIP6 C _{OFF} : 130 pF (typ.)	3 mA	2 Ω	5 mA	0.5 A	60 V	2500 V _{rms}	○/—				
TLP598GA		DIP6	3 mA	12 Ω	5 mA	0.15 A	400 V	2500 V _{rms}	○/—				
TLP797GA TLP797GAF		DIP6 C _{OFF} : 40 pF (typ.)	3 mA	35 Ω	5 mA	0.12 A	400 V	5000 V _{rms}	○/—	△	△	△	△
TLP797J TLP797JF		DIP6 C _{OFF} : 120 pF (typ.)	5 mA	35 Ω	10 mA	0.1 A	600 V	5000 V _{rms}	○/○	△	△	△	△
TLP798GA		DIP6	5 mA	12 Ω	5 mA	0.15 A	400 V	5000 V _{rms}	○/—	△	△	△	△
TLP3542		DIP6 High output current: 2.5 A (max) C _{OFF} : 400 pF (typ.)	3 mA	0.1 Ω	10 mA	2.5 A	60 V	2500 V _{rms}	○/○				
TLP3543*		DIP6 High output current: 4 A (max)	3 mA	0.05 Ω	5 mA	4 A	20 V	2500 V _{rms}	△/△				
TLP3544*		DIP6 High output current: 3.5 A (max)	3 mA	0.06 Ω	5 mA	3.5 A	40 V	2500 V _{rms}	△/△				
TLP3545*		DIP6 High output current: 3 A (max)	3 mA	0.07 Ω	5 mA	3 A	60 V	2500 V _{rms}	△/△				
TLP3546*	DIP6 High output current: 2 A (max)	3 mA	0.2 Ω	5 mA	2 A	100 V	2500 V _{rms}	△/△					

MOSFET-Output Photorelays, 2-Form-A in a DIP8 Package

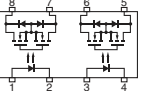
Part Number	Pin Configuration	Features	I _{FT} (Max)	R _{ON} (Max)		I _{ON} (Max)	V _{OFF}	BV _s	Safety Standards ⁽²⁾				
					@ I _F				UL/cUL	TÜV	VDE	BSI	IEC
TLP222A-2		DIP8 Dual-channel version of the TLP222A	3 mA	2 Ω	5 mA	0.5 A	60 V	2500 V _{rms}	○/○				
TLP222G-2		DIP8 Dual-channel version of the TLP222G SEMKO-approved	3 mA	50 Ω	5 mA	0.12 A	350 V	2500 V _{rms}	○/○			○	○
TLP224G-2		DIP8 Dual-channel version of the TLP224G SEMKO-approved	3 mA	35 Ω	5 mA	0.12 A	350 V	2500 V _{rms}	○/○			○	○
TLP224GA-2		DIP8 Current-limiting function Limit current: 150 to 300 mA	3 mA	35 Ω	5 mA	0.12 A	400 V	2500 V _{rms}	○/—				
TLP227A-2		DIP8 Dual-channel version of the TLP227A SEMKO-approved	3 mA	2 Ω	5 mA	0.5 A	60 V	2500 V _{rms}	○/○				△

Note 1: The EN60747-5-2 safety standard for compact packages is different from that for standard DIP packages.

Since the mini-flat package is a compact package, please contact your nearest Toshiba sales representative for more details.

Note 2: BSI and IEC: ○: Approved (supplementary or basic insulation) ◎: Approved (reinforced insulation) △: Design which meets safety standard/approval pending as of January 2011
EN 60065- and IEC 60065-approved, EN 60950- and IEC 60950-approved

TÜV and VDE: ○: Approved △: Design which meets safety standard/approval pending as of January 2011

EN 60747-5-2-approved with option V4 or D4

For the latest information, please contact your nearest Toshiba sales representative.

4 Selection Guide

MOSFET-Output Photorelays, 2-Form-A in a DIP8 Package (Continued)

Part Number	Pin Configuration	Features	IFT (Max)	RON (Max)		ION (Max)	VOFF	BVs	Safety Standards (2)				
				@IF					UL/cUL	TÜV	VDE	BSI	IEC
TLP227G-2		DIP8 Dual-channel version of the TLP227G SEMKO-approved	3 mA	35 Ω	5 mA	0.12 A	350 V	2500 Vrms	○/○	△	○	○	○
TLP227GA-2		DIP8 Dual-channel version of the TLP227GA SEMKO-approved	3 mA	35 Ω	5 mA	0.12 A	400 V	2500 Vrms	○/—				△

Note 1: The EN60747-5-2 safety standard for compact packages is different from that for standard DIP packages.

Since the mini-flat package is a compact package, please contact your nearest Toshiba sales representative for more details.

Note 2: BSI and IEC: ○: Approved (supplementary or basic insulation) ◎: Approved (reinforced insulation) △: Design which meets safety standard/approval pending as of January 2011
EN 60065- and IEC 60065-approved, EN 60950- and IEC 60950-approved

TÜV and VDE: ○: Approved △: Design which meets safety standard/approval pending as of January 2011

EN 60747-5-2-approved with option V4 or D4

For the latest information, please contact your nearest Toshiba sales representative.

5 Photorelays (1-Form-B, 2-Form-B and 1-Form-A/1-Form-B)

Features		Package			2.54SOP4		2.54SOP6		2.54SOP8		DIP4		DIP6		DIP8	
		Off-State Voltage (max) (V)	On-State Resistance (max) (Ω)	On-State Current (max) (A)												
1-Form-B, 2-Form-B	350	50	0.09	TLP4172G	TLP4192G	TLP4202G*										
		50	0.10					TLP4222G	TLP4592G	TLP4222G-2*						
		25	0.12	TLP4176G	TLP4197G	TLP4206G*										
		25	0.15					TLP4227G	TLP4597G	TLP4227G-2*						
1-Form-A/ 1-Form-B	350	50	0.09			TLP4027G*										
		50	0.10												TLP4007G*	
		25	0.12			TLP4026G*								TLP4006G*		

* Dual-channel

MOSFET-Output Photorelays, 1-Form-B

Part Number	Pin Configuration	Features	IFT (Max)	RON (Max)		ION (Max)	VOFF	BVs	Safety Standards (2)					
				@IF					UL/cUL	TÜV	VDE	BSI	IEC	
TLP4172G		2.54SOP4 Lead pitch: 2.54 mm 1-Form-B	3 mA	50 Ω	0 mA	0.09 A	350 V	1500 Vrms	○/—					
TLP4192G		2.54SOP6 Lead pitch: 2.54 mm 1-Form-B	3 mA	50 Ω	0 mA	0.09 A	350 V	1500 Vrms	○/—					
TLP4222G		DIP4 1-Form-B	3 mA	50 Ω	0 mA	0.1 A	350 V	2500 Vrms	○/—					
TLP4592G		DIP6 1-Form-B	3 mA	50 Ω	0 mA	0.1 A	350 V	2500 Vrms	○/—					
TLP4176G		2.54SOP4 Lead pitch: 2.54 mm 1-Form-B	3 mA	25 Ω	0 mA	0.12 A	350 V	1500 Vrms	○/—					
TLP4197G		2.54SOP6 Lead pitch: 2.54 mm 1-Form-B	3 mA	25 Ω	0 mA	0.12 A	350 V	1500 Vrms	○/—					

Note 2: BSI and IEC: ○: Approved (supplementary or basic insulation) ◎: Approved (reinforced insulation) △: Design which meets safety standard/approval pending as of January 2011
EN 60065- and IEC 60065-approved, EN 60950- and IEC 60950-approved

TÜV and VDE: ○: Approved △: Design which meets safety standard/approval pending as of January 2011

EN 60747-5-2-approved with option V4 or D4

For the latest information, please contact your nearest Toshiba sales representative.

MOSFET-Output Photorelays, 1-Form-B (Continued)

Part Number	Pin Configuration	Features	I _{FT} (Max)	R _{ON} (Max)		I _{ON} (Max)	V _{OFF}	BV _S	Safety Standards ⁽²⁾					
					@ I _F				UL/cUL	TÜV	VDE	BSI	IEC	
TLP4227G		DIP4 1-Form-B SEMKO-approved	3 mA	25 Ω	0 mA	0.15 A	350 V	2500 Vrms	○ / -					△
TLP4597G		DIP6 1-Form-B SEMKO-approved	3 mA	25 Ω	0 mA	0.15 A	350 V	2500 Vrms	○ / -					△

MOSFET-Output Photorelays, 2-Form-B

Part Number	Pin Configuration	Features	I _{FT} (Max)	R _{ON} (Max)		I _{ON} (Max)	V _{OFF}	BV _S	Safety Standards ⁽²⁾					
					@ I _F				UL/cUL	TÜV	VDE	BSI	IEC	
TLP4202G		2.54SOP8 Lead pitch: 2.54 mm Dual-channel version of the TLP4172G 2-Form-B	3 mA	50 Ω	0 mA	0.09 A	350 V	1500 Vrms	○ / -					
TLP4222G-2		DIP8 Dual-channel version of the TLP4222G 2-Form-B	3 mA	50 Ω	0 mA	0.1 A	350 V	2500 Vrms	○ / -					
TLP4206G		2.54SOP8 Lead pitch: 2.54 mm Dual-channel version of the TLP4176G 2-Form-B	3 mA	25 Ω	0 mA	0.12 A	350 V	1500 Vrms	○ / -					
TLP4227G-2		DIP8 Dual-channel version of the TLP4227G 2-Form-B SEMKO-approved	3 mA	25 Ω	0 mA	0.15 A	350 V	2500 Vrms	○ / -					△

MOSFET-Output Photorelays, 1-Form-A/1-Form-B

Part Number	Pin Configuration	Features	I _{FT} (Max)	R _{ON} (Max)		I _{ON} (Max)	V _{OFF}	BV _S	Safety Standards ⁽²⁾					
					@ I _F				UL/cUL	TÜV	VDE	BSI	IEC	
TLP4027G		2.54SOP8 Lead pitch: 2.54 1a1b (N.C. + N.O.)	3 mA	50 Ω	(Form-A) 5 mA (Form-B) 0 mA	0.09 A	350 V	1500 Vrms	○ / -					
TLP4007G		DIP8 1a1b (N.C. + N.O.)	3 mA	50 Ω	(Form-A) 5 mA (Form-B) 0 mA	0.1 A	350 V	2500 Vrms	△ / -					
TLP4026G		2.54SOP8 Lead pitch: 2.54 1a1b (N.C. + N.O.)	3 mA	25 Ω	(Form-A) 5 mA (Form-B) 0 mA	0.12 A	350 V	1500 Vrms	○ / -					
TLP4006G		DIP8 1a1b (N.C. + N.O.)	3 mA	25 Ω	(Form-A) 5 mA (Form-B) 0 mA	0.12 A	350 V	2500 Vrms	△ / -					

Note 2: BSI and IEC: ○: Approved (supplementary or basic insulation) ©: Approved (reinforced insulation) △: Design which meets safety standard/approval pending as of January 2011
 EN 60065- and IEC 60065-approved, EN 60950- and IEC 60950-approved
 TÜV and VDE: ○: Approved △: Design which meets safety standard/approval pending as of January 2011
 EN 60747-5-2-approved with option V4 or D4
 For the latest information, please contact your nearest Toshiba sales representative.

4 Selection Guide

6 Triac-Output Photocouplers

Package		MFSOP6		DIP6		DIP4/8/16		SO6	
		NZC	ZC	NZC	ZC	NZC	ZC	NZC	ZC
V _{DRM}	Isolation voltage								
	400 V	2500 Vrms	TLP160G	TLP161G	TLP560G	TLP561G	TLP525G/-2/-4		
	5000 Vrms			TLP3022(S) TLP3023(S)	TLP3042(S) TLP3043(S)				
600 V	2500 Vrms		TLP160J TLP165J	TLP161J TLP163J TLP166J	TLP560J	TLP561J			
		3000 Vrms	TLP260J	TLP261J					
	3750 Vrms		TLP168J						
	4000 Vrms				TLP762J	TLP763J			
	5000 Vrms			TLP3052(S)	TLP3762(S) TLP3062(S) TLP3063(S) TLP3064(S)	TLP360J	TLP361J TLP363J		
800 V	5000 Vrms				TLP3082(S) TLP3782(S) TLP3783(S)				

*Under development. Specifications subject to change without notice. For the latest information, please contact your nearest Toshiba sales representative.

NZC: Non-zero cross

ZC: Zero cross

Triac-Output Photocouplers for Solid State Relays (SSRs)

Part Number	Pin Configuration	Features	I _{FT} (Max)		V _{TM} (Max)		V _{DRM}	BV _s	Safety Standards ⁽²⁾				
			Rank			@ I _{TM}			UL/c-UL	TÜV	VDE	BSI	IEC
TLP160G		Mini-flat MFSOP6 Non-zero cross	-	10 mA	2.8 V	70 mA	400 V	2500 Vrms	○/○	△	○ ⁽¹⁾		
			IFT7	7 mA									
			IFT5	5 mA									
TLP161G		Mini-flat MFSOP6 Zero cross	-	10 mA	2.8 V	70 mA	400 V	2500 Vrms	○/○	△	○ ⁽¹⁾		
			IFT7	7 mA									
			IFT5	5 mA									
TLP160J TLP165J		Mini-flat MFSOP6 Non-zero cross	-	10 mA	2.8 V	70 mA	600 V	2500 Vrms	○/○	△	○ ⁽¹⁾		
			IFT7	7 mA									
TLP161J TLP166J		Mini-flat MFSOP6 Zero cross	-	10 mA	2.8 V	70 mA	600 V	2500 Vrms	○/○	△	○ ⁽¹⁾		
			IFT7	7 mA									
TLP168J		Mini-flat MFSOP6 Zero cross Low trigger current	-	3 mA	2.8 V	70 mA	600 V	2500 Vrms	○/○				
TLP163J		Mini-flat MFSOP6 Zero cross High impulse noise immunity V _N =2000 V (typ.)	-	10 mA	2.8 V	100 mA	600 V	2500 Vrms	○/○	△	△		

Note 1: The EN60747-5-2 safety standard for compact packages is different from that for standard DIP packages.

Since the mini-flat package is a compact package, please contact your nearest Toshiba sales representative for more details.

Note 2: BSI and IEC: ○: Approved (supplementary or basic insulation) ◎: Approved (reinforced insulation) △: Design which meets safety standard/approval pending as of January 2011

EN 60065- and IEC 60065-approved, EN 60950- and IEC 60950-approved

TÜV and VDE: ○: Approved △: Design which meets safety standard/approval pending as of January 2011

EN 60747-5-2-approved with option V4 or D4

For the latest information, please contact your nearest Toshiba sales representative.

Triac-Output Photocouplers for Solid State Relays (SSRs) (Continued)

Part Number	Pin Configuration	Features	I _{FT} (Max)		V _{TM} (Max)		V _{DRM}	BV _s	Safety Standards ⁽²⁾				
			Rank			@ I _{TM}			UL/c-UL	TÜV	VDE	BSI	IEC
TLP260J		Mini-flat MFSOP6 Non-zero cross	-	10 mA	2.8 V	70 mA	600 V	3000 Vrms	○/—	△	○ ⁽¹⁾		
TLP261J		Mini-flat MFSOP6 Zero cross	-	10 mA	2.8 V	70 mA	600 V	3000 Vrms	○/—	△	○ ⁽¹⁾		

Triac-Output Photocouplers for Office Equipment

Part Number	Pin Configuration	Features	I _{FT} (Max)		V _{TM} (Max)		V _{DRM}	BV _s	Safety Standards ⁽²⁾				
			Rank			@ I _{TM}			UL/c-UL	TÜV	VDE	BSI	IEC
TLP360J TLP360JF		DIP4 Non-zero cross	-	10 mA	2.8 V	70 mA	600 V	5000 Vrms	○/○	○	○		
			IFT7	7 mA									
TLP361J TLP361JF		DIP4 Zero cross	-	10 mA	2.8 V	70 mA	600 V	5000 Vrms	○/○	○	○		
			IFT7	7 mA									
TLP363J TLP363JF		DIP4 Zero cross High impulse noise immunity V _N = 2000 V (typ.)	-	10 mA	2.8 V	70 mA	600 V	5000 Vrms	○/○	○	○		

Triac-Output Photocouplers for AC 100 to 120 V Lines

Part Number	Pin Configuration	Features	I _{FT} (Max)		V _{TM} (Max)		V _{DRM}	BV _s	Safety Standards ⁽²⁾				
			Rank			@ I _{TM}			UL/c-UL	TÜV	VDE	BSI	IEC
TLP525G		DIP4	-	10 mA	3 V	100 mA	400 V	2500 Vrms	○/○				
TLP525G-2		DIP8 Dual-channel version of the TLP525G	-	10 mA	3 V	100 mA	400 V	2500 Vrms	○/○				
TLP525G-4		DIP16 4-channel version of the TLP525G	-	10 mA	3 V	100 mA	400 V	2500 Vrms	○/○				
TLP560G		DIP6 General-purpose Non-zero cross	-	10 mA	3 V	100 mA	400 V	2500 Vrms	○/—	△	○		
			IFT7	7 mA									
			IFT5	5 mA									

Note 2: BSI and IEC: ○: Approved (supplementary or basic insulation) ◎: Approved (reinforced insulation) △: Design which meets safety standard/approval pending as of January 2011
 EN 60065- and IEC 60065-approved, EN 60950- and IEC 60950-approved
 TÜV and VDE: ○: Approved △: Design which meets safety standard/approval pending as of January 2011
 EN 60747-5-2-approved with option V4 or D4
 For the latest information, please contact your nearest Toshiba sales representative.

4 Selection Guide

Triac-Output Photocouplers for AC 100 to 120 V Lines (Continued)

Part Number	Pin Configuration	Features	IFT (Max)		V _{TM} (Max)		V _{DRM}	BV _s	Safety Standards ⁽²⁾				
			Rank			@I _{TM}			UL/c-UL	TÜV	VDE	BSI	IEC
TLP561G		DIP6 General-purpose Zero cross	-	10 mA	3 V	100 mA	400 V	2500 Vrms	○/-	△	○		
			IFT7	7 mA									
			IFT5	5 mA									
TLP3022(S) TLP3022F(S)		DIP6 Direct replacement for XXX3020/3021/3022 SEMKO-approved Non-zero cross	-	10 mA	3 V	100 mA	400 V	5000 Vrms	○/○	△	○	◎	◎
TLP3023(S) TLP3023F(S)		DIP6 Direct replacement for XXX3023 SEMKO-approved Non-zero cross	-	5 mA	3 V	100 mA	400 V	5000 Vrms	○/○	△	○	◎	◎
TLP3042(S) TLP3042F(S)		DIP6 Direct replacement for XXX3040/3041/3042 SEMKO-approved Zero cross	-	10 mA	3 V	100 mA	400 V	5000 Vrms	○/○	△	○	◎	◎
TLP3043(S) TLP3043F(S)		DIP6 Direct replacement for XXX3043 SEMKO-approved Zero cross	-	5 mA	3 V	100 mA	400 V	5000 Vrms	○/○	△	○	◎	◎

Triac-Output Photocouplers for AC 200 to 240 V Line

Part Number	Pin Configuration	Features	IFT (Max)		V _{TM} (Max)		V _{DRM}	BV _s	Safety Standards ⁽²⁾				
			Rank			@I _{TM}			UL/c-UL	TÜV	VDE	BSI	IEC
TLP560J		DIP6 General-purpose Non-zero cross	-	10 mA	3 V	100 mA	600 V	2500 Vrms	○/-	△	○		
			IFT7	7 mA									
TLP561J		DIP6 General-purpose Zero cross	-	10 mA	3 V	100 mA	600 V	2500 Vrms	○/-	△	○		
			IFT7	7 mA									
TLP762J TLP762JF		DIP6 Internal creepage: 4 mm (min) SEMKO-approved Non-zero cross-on	-	10 mA	3 V	100 mA	600 V	4000 Vrms	○/-	△	○	◎	◎
TLP763J TLP763JF		DIP6 Internal creepage: 4 mm (min) SEMKO-approved Zero cross	-	10 mA	3 V	100 mA	600 V	4000 Vrms	○/-	△	○	◎	◎
TLP3052(S) TLP3052F(S)		DIP6 High V _{DRM} SEMKO-approved Non-zero cross-on	-	10 mA	3 V	100 mA	600 V	5000 Vrms	○/○	△	○	◎	◎

Note 2: BSI and IEC: ○: Approved (supplementary or basic insulation) ◎: Approved (reinforced insulation) △: Design which meets safety standard/approval pending as of January 2011
 EN 60065- and IEC 60065-approved, EN 60950- and IEC 60950-approved
 TÜV and VDE: ○: Approved △: Design which meets safety standard/approval pending as of January 2011
 EN 60747-5-2-approved with option V4 or D4
 For the latest information, please contact your nearest Toshiba sales representative.

Triac-Output Photocouplers for AC 200 to 240 V Line (Continued)

Part Number	Pin Configuration	Features	IFT (Max)		V _{TM} (Max)		V _{DRM}	BV _s	Safety Standards ⁽²⁾				
			Rank		@ I _{TM}				UL/c-UL	TÜV	VDE	BSI	IEC
TLP3062(S) TLP3062F(S)		DIP6 SEMKO-approved High V _{DRM} Zero cross	-	10 mA	3 V	100 mA	600 V	5000 V _{rms}	○/○	△	○	○	○
TLP3063(S) TLP3063F(S)		DIP6 SEMKO-approved High V _{DRM} Zero cross	-	5 mA	3 V	100 mA	600 V	5000 V _{rms}	○/○	△	○	○	○
TLP3064(S) TLP3064F(S)		DIP6 SEMKO-approved Low trigger current Zero cross	-	3 mA	3 V	100 mA	600 V	5000 V _{rms}	○/○	△	○	○	○
TLP3762(S) TLP3762F(S)		DIP6 Zero cross High impulse noise immunity V _N = 2000 V (typ.)	-	10 mA	3 V	100 mA	600 V	5000 V _{rms}	○/○	△	○		
TLP3082(S) TLP3082F(S)		DIP6 Zero cross	-	10 mA	3 V	100 mA	800 V	5000 V _{rms}	○/○	△	○		
TLP3782(S) TLP3782F(S)		DIP6 High impulse noise immunity V _N = 1500 V (typ.)	-	10 mA	3 V	100 mA	800 V	5000 V _{rms}	○/○	△	○		
TLP3783(S) TLP3783F(S)	DIP6 Zero cross	-	5 mA	3 V	100 mA	800 V	5000 V _{rms}	○/○	△	○			

Note 2: BSI and IEC: ○: Approved (supplementary or basic insulation) ◎: Approved (reinforced insulation) △: Design which meets safety standard/approval pending as of January 2011
 EN 60065- and IEC 60065-approved, EN 60950- and IEC 60950-approved
 TÜV and VDE: ○: Approved △: Design which meets safety standard/approval pending as of January 2011
 EN 60747-5-2-approved with option V4 or D4
 For the latest information, please contact your nearest Toshiba sales representative.

7 Thyristor-Output Photocouplers

Package				
V _{DRM}	Isolation voltage	MFSOP6	DIP6	DIP8
400 V	2500 V _{rms}	TLP148G		
600 V	2500 V _{rms}		TLP548J	TLP549J
	4000 V _{rms}		TLP748J	

Replacement Devices

New Device	Discontinued Devices		
TLP148G	TLP141G		
TLP548J	TLP541J	TLP545J	
TLP549J	TLP542G	TLP543J	
TLP748J	TLP641G/J	TLP741G/J	TLP747G/J



The new and discontinued devices are not exactly identical in terms of electrical characteristics. For device replacement, hardware evaluation must be performed in the real-world environment.

Part Number	Pin Configuration	Features	IFT (Max)	V _{TM} (Max)		V _{DRM}	BV _s	Safety Standards ⁽²⁾					
					@ I _{TM}			UL/cUL	TÜV	VDE	BSI	IEC	
TLP148G		Mini-flat MFSOP6	10 mA	1.45 V	100 mA	400 V	2500 V _{rms}	○/—					
TLP548J		DIP6 Low trigger current	7 mA	1.45 V	100 mA	600 V	2500 V _{rms}	○/—					
TLP549J		DIP8 Long anode-cathode distance (SCR)	7 mA	1.45 V	100 mA	600 V	2500 V _{rms}	○/—					
TLP748J TLP748JF		DIP6 SEMKO-approved	10 mA	1.45 V	100 mA	600 V	4000 V _{rms}	○/—		○	○	△	

Note 2: BSI and IEC: ○: Approved (supplementary or basic insulation) ◎: Approved (reinforced insulation) △: Design which meets safety standard/approval pending as of January 2011
 EN 60065- and IEC 60065-approved, EN 60950- and IEC 60950-approved
 TÜV and VDE: ○: Approved △: Design which meets safety standard/approval pending as of January 2011
 EN 60747-5-2-approved with option V4 or D4
 For the latest information, please contact your nearest Toshiba sales representative.

4 Selection Guide

8 Photovoltaic-Output photocouplers

Package				
Short-Circuit Current	Open Voltage	SSOP4	MFSOP6	DIP6
		1500 Vrms	2500 Vrms	
5 μ A	7 V	TLP3904	TLP3902	
12 μ A	7 V		TLP190B	TLP590B
20 μ A	7 V	TLP3914		
24 μ A	7 V		TLP191B*	TLP591B*
4 μ A	30 V	TLP3924		

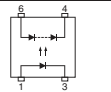
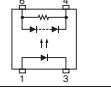
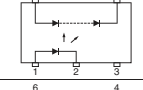
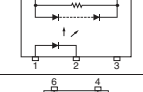
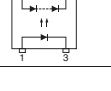
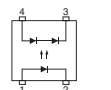

*Built-in shunt resistor

Part Number	Pin Configuration	Features	Short-Circuit Current (Min)		Open-Circuit Voltage (Min)		BV _s	Safety Standards ⁽²⁾					
			Rank	@ I _F	@ I _F	@ I _F		UL/cUL	TÜV	VDE	BSI	IEC	
TLP190B		Mini-flat MFSOP6	—	12 μ A	10 mA	7 V	10 mA	2500 Vrms	○/○				
TLP191B		Mini-flat MFSOP6 Built-in shunt resistor	—	24 μ A	20 mA	7 V	20 mA	2500 Vrms	○/○				
TLP590B		DIP6	—	12 μ A	10 mA	7 V	10 mA	2500 Vrms	○/—				
			C20	20 μ A									
TLP591B		DIP6 Built-in shunt resistor	—	24 μ A	20 mA	7 V	20 mA	2500 Vrms	○/—				
			C40	40 μ A									
TLP3902		Mini-flat MFSOP6	—	5 μ A	10 mA	7 V	10 mA	2500 Vrms	△/—				
TLP3904		SSOP4	—	5 μ A	10 mA	7 V	10 mA	1500 Vrms	○/—				
TLP3914		SSOP4	—	20 μ A	10 mA	7 V	10 mA	1500 Vrms	○/—				
TLP3924		SSOP4 High open-circuit voltage	—	4 μ A	10 mA	30 V	10 mA	1500 Vrms	○/—				

Note 2: BSI and IEC: ○: Approved (supplementary or basic insulation) ◎: Approved (reinforced insulation) △: Design which meets safety standard/approval pending as of January 2011
 EN 60065- and IEC 60065-approved, EN 60950- and IEC 60950-approved
 TÜV and VDE: ○: Approved △: Design which meets safety standard/approval pending as of January 2011
 EN 60747-5-2-approved with option V4 or D4
 For the latest information, please contact your nearest Toshiba sales representative.

9 Products Manufactured by Toshiba Semiconductor (Thailand) Co., Ltd. (TST)

Transistor-Output and Darlington-Transistor-Output Photocouplers

Part Number	Pin Configuration	Features	V _{CEO}	BV _s @ 1 Minute	Safety Standards ⁽²⁾					
					UL	c-UL	TÜV	VDE	BSI	IEC
TLP180		Mini-flat MFSOP6 AC input SEMKO-approved	80 V	3750 Vrms	○	○	○ ⁽¹⁾	○ ⁽¹⁾	◎	◎
TLP181		Mini-flat MFSOP6 Transistor output General-purpose	80 V	3750 Vrms	○	○	△	○ ⁽¹⁾	◎	◎

*Under development. Specifications subject to change without notice. For the latest information, please contact your nearest Toshiba sales representative.

Note 1: The EN60747-5-2 safety standard for compact packages is different from that for standard DIP packages.

Since the mini-flat package is a compact package, please contact your nearest Toshiba sales representative for more details.

Note 2: BSI and IEC: ○: Approved (supplementary or basic insulation) ◎: Approved (reinforced insulation) △: Design which meets safety standard/approval pending as of January 2011
 EN 60065- and IEC 60065-approved, EN 60950- and IEC 60950-approved

TÜV and VDE: ○: Approved △: Design which meets safety standard/approval pending as of January 2011
 EN 60747-5-2-approved with option V4 or D4

For the latest information, please contact your nearest Toshiba sales representative.

Some of the photocouplers with triac output are also manufactured by Toshiba Semiconductor Thailand Co.,Ltd. For detailed information, please contact your nearest Toshiba sales representative.

Transistor-Output and Darlington-Transistor-Output Photocouplers (Continued)

Part Number	Pin Configuration	Features	V _{CEO}	BV _s @ 1 Minute	Safety Standards ⁽²⁾					
					UL	c-UL	TÜV	VDE	BSI	IEC
TLP184*		SO6 (reinforced insulation) AC input	80 V	3750 Vrms	△	△	△ ⁽¹⁾	△ ⁽¹⁾	△	△
TLP185*		SO6 (reinforced insulation)	80 V	3750 Vrms	△	△	△ ⁽¹⁾	△ ⁽¹⁾	△	△
TLP280		SOP4 Lead pitch = 1.27 mm AC input	80 V	2500 Vrms	○	○	○ ⁽¹⁾	○ ⁽¹⁾	△	△
TLP281		SOP4 Lead pitch = 1.27 mm General-purpose SEMKO-approved	80 V	2500 Vrms	○	○	△	○ ⁽¹⁾	◎	◎
TLP284		SOP4 (reinforced insulation) Lead pitch = 1.27 mm Creepage/clearance ≥ 5 mm Isolation thickness ≥ 0.4 mm AC input	80 V	3750 Vrms	○	○	○ ⁽¹⁾	○ ⁽¹⁾	◎	◎
TLP285		SOP4 (reinforced insulation) Lead pitch = 1.27 mm Creepage/clearance ≥ 5 mm Isolation thickness ≥ 0.4 mm SEMKO-approved	80 V	3750 Vrms	○	○	○ ⁽¹⁾	○ ⁽¹⁾	◎	◎
TLP620		DIP4 Transistor output AC input SEMKO-approved	55 V	5000 Vrms	○	—	△	○	◎	◎
TLP620-2		DIP8 Dual-channel version of the TLP620 SEMKO-approved	55 V	5000 Vrms	○	—	△	○	◎	◎
TLP627		DIP4 Darlington transistor output High V _{CEO} SEMKO-approved	300 V	5000 Vrms	○	—	△	○	◎	◎
TLP627-2		DIP8 Dual-channel version of the TLP627 SEMKO-approved	300 V	5000 Vrms	○	—	△	○	◎	◎
TLP290-4*		SO16 4-channel version Lead pitch = 1.27 mm AC input	80 V	2500 Vrms	△	△		△ ⁽²⁾	△	△
TLP291-4*		SO16 4-channel version Lead pitch = 1.27 mm	80 V	2500 Vrms	△	△		△ ⁽²⁾	△	△

Photocouplers for IGBT/MOSFET Gate Drive

Part Number	Pin Configuration	Features	Propagation Delay Time (Max)	Output	I _{FHL} (Max)	BV _s	Safety Standards ⁽²⁾				
							UL/cUL	TÜV	VDE	BSI	IEC
TLP155E		SO6 (reinforced Insulation) T _{opr} = 100°C (max) Direct drive of a small-power IGBT/MOSFET	0.2 μs	Peak output current (max): ±0.6 A	7.5 mA	3750 Vrms	○/○		○		

*Under development. Specifications subject to change without notice. For the latest information, please contact your nearest Toshiba sales representative.

Note 1: The EN60747-5-2 safety standard for compact packages is different from that for standard DIP packages.

Since the mini-flat package is a compact package, please contact your nearest Toshiba sales representative for more details.

Note 2: BSI and IEC: ○: Approved (supplementary or basic insulation) ◎: Approved (reinforced insulation) △: Design which meets safety standard/approval pending as of January 2011

EN 60065- and IEC 60065-approved, EN 60950- and IEC 60950-approved

TÜV and VDE: ○: Approved △: Design which meets safety standard/approval pending as of January 2011

EN 60747-5-2-approved with option V4 or D4

For the latest information, please contact your nearest Toshiba sales representative.

Some of the photocouplers with triac output are also manufactured by Toshiba Semiconductor Thailand Co.,Ltd. For detailed information, please contact your nearest Toshiba sales representative.

4 Selection Guide

Triac-Output Photocouplers

Part Number	Pin Configuration	Features	Tingger LED Current, I _{FT}		Peak On-State Voltage, V _{TM}		Off-State Output Terminal Voltage V _{DRM}	BV _s @ 1 Minute	Safety Standards ⁽²⁾																					
			Rank	Max	Max	@ I _{TM}			UL	c-UL	TÜV	VDE	BSI	IEC																
TLP360J TLP360JF		DIP4 Non-zero cross	-	10 mA	3.0 V	100 mA	600 V	5000 Vrms	○	△	△	○																		
			IFT7	7 mA																										
TLP361J TLP361JF		DIP4 Zero cross	-	10 mA	3.0 V	100 mA	600 V	5000 Vrms	○		△	○																		
			IFT7	7 mA																										
TLP363J TLP363JF		DIP4 Zero cross High impulse noise immunity V _N = 2000 V (typ.)	-	10 mA					○	△	△	○																		
TP560G TP560J		DIP6 General-purpose Non-zero cross	-	10 mA	3.0 V	100 mA	400 V	2500 Vrms	○																					
			IFT7	7 mA																										
TP561G TP561J		DIP6 General-purpose Zero cross	-	10 mA	3.0 V	100 mA	400 V	2500 Vrms	○																					
			IFT7	7 mA																										
TLP3022 (S) TLP3022F (S)		DIP6 SEMKO-approved Non-zero cross	-	10 mA	3.0 V	100 mA	400 V	5000 Vrms	○	○	△	○	◎	△																
			IFT7	5 mA																										
TLP3052 (S) TLP3052F (S)		DIP6 High V _{DRM} SEMKO-approved Non-zero cross	-	10 mA			600 V																							
TLP3042 (S)		DIP6 SEMKO-approved Zero cross	-	10 mA	3.0 V	100 mA	400 V	5000 Vrms	○		△	○	◎	△																
TLP3043 (S)			-	5 mA																										
TLP3062 (S) TLP3062F (S)		DIP6 SEMKO-approved High V _{DRM}	-	10 mA			600 V								5000 Vrms	○		△	○	◎	△									
			TLP3063 (S) TLP3063F (S)	-																		5 mA								
TLP3064 (S)		DIP6 SEMKO-approved Zero cross	-	3 mA																										
TLP3082 (S)		DIP6 Zero cross	-	10 mA			600 V																							
TLP3782 (S) TLP3782F (S)		DIP6 High impulse noise immunity	-	10 mA			600 V																		○		△	○		
			TLP3783 (S) TLP3783F (S)	-																										





Note 2: BSI and IEC: ○: Approved (supplementary or basic insulation) ◎: Approved (reinforced insulation) △: Design which meets safety standard/approval pending as of January 2011
 EN 60065- and IEC 60065-approved, EN 60950- and IEC 60950-approved
 TÜV and VDE: ○: Approved △: Design which meets safety standard/approval pending as of January 2011
 EN 60747-5-2-approved with option V4 or D4

For the latest information, please contact your nearest Toshiba sales representative.
 Some of the photocouplers with triac output are also manufactured by Toshiba Semiconductor Thailand Co.,Ltd. For detailed information, please contact your nearest Toshiba sales representative.

6 Package Information

1 Lead Form Options for DIP Packages

The **DIP4**, **DIP6**, **DIP8** and **DIP16** packages offer three surface-mount lead form options and a wide-spaced lead form option. The electrical characteristics are identical, regardless of these options.

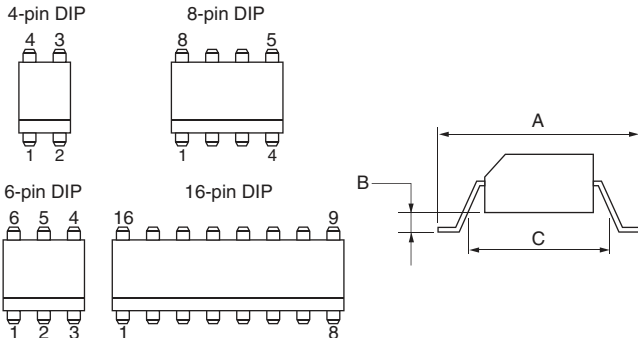
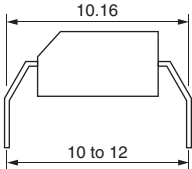
Lead Form	Surface-Mount			Wide-Spaced																																		
Appearance																																						
Lead Form Code	(LF1)	(LF4)	(LF5)	(LF2)																																		
Carrier Tape Code	(TP1)	(TP4)	(TP5)	Not available*																																		
Package Outlines	 <p>Dimensions Unit: mm</p> <table border="1"> <thead> <tr> <th rowspan="2">Version</th> <th colspan="2">(LF1)</th> <th colspan="2">(LF4)</th> <th colspan="2">(LF5)</th> </tr> <tr> <th>Min</th> <th>Max</th> <th>Min</th> <th>Max</th> <th>Min</th> <th>Max</th> </tr> </thead> <tbody> <tr> <td>A</td> <td>–</td> <td>10.0</td> <td>–</td> <td>12.0</td> <td>–</td> <td>10.0</td> </tr> <tr> <td>B</td> <td colspan="2">(0.35 typ.)</td> <td colspan="2">(0.25 typ.)</td> <td>–</td> <td>0.2</td> </tr> <tr> <td>C</td> <td>6.4</td> <td>–</td> <td>8.0</td> <td>–</td> <td>6.4</td> <td>–</td> </tr> </tbody> </table> <p>All other package dimensions are the same as for each standard package specification.</p>			Version	(LF1)		(LF4)		(LF5)		Min	Max	Min	Max	Min	Max	A	–	10.0	–	12.0	–	10.0	B	(0.35 typ.)		(0.25 typ.)		–	0.2	C	6.4	–	8.0	–	6.4	–	
Version	(LF1)		(LF4)		(LF5)																																	
	Min	Max	Min	Max	Min	Max																																
A	–	10.0	–	12.0	–	10.0																																
B	(0.35 typ.)		(0.25 typ.)		–	0.2																																
C	6.4	–	8.0	–	6.4	–																																

* Tape-and-reel packing is not available with (LF2).

Example 1: Standard part: TLP620(F)

Surface-mount option: TLP620(LF1,F): Packed in stick magazines (see page 49).

Surface-mount and tape-and-reel options: TLP620(TP1,F): Packed in tape-and-reel (see page 51).

- Standard part names should be used when applying for safety standard approval.
- The package dimensions and lead form options of the TLP781, TLP785 differ from those shown above. See the TLP781, TLP785 datasheet.

2 Package Dimensions (4-Pin DIP)

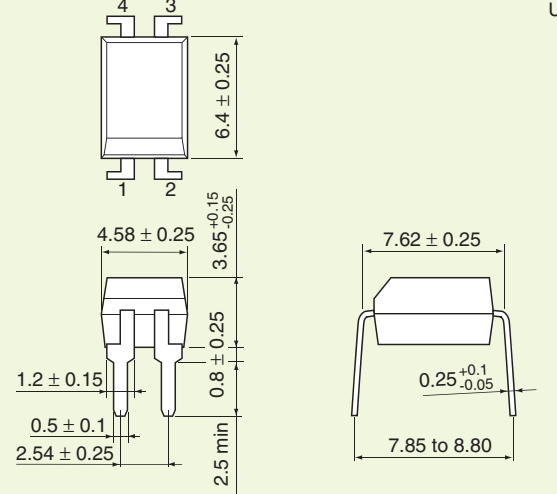
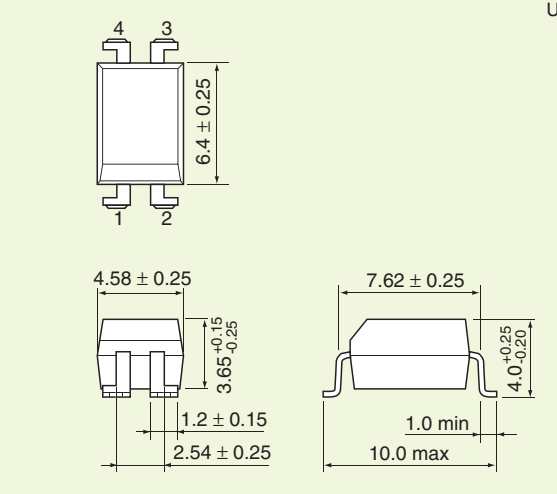
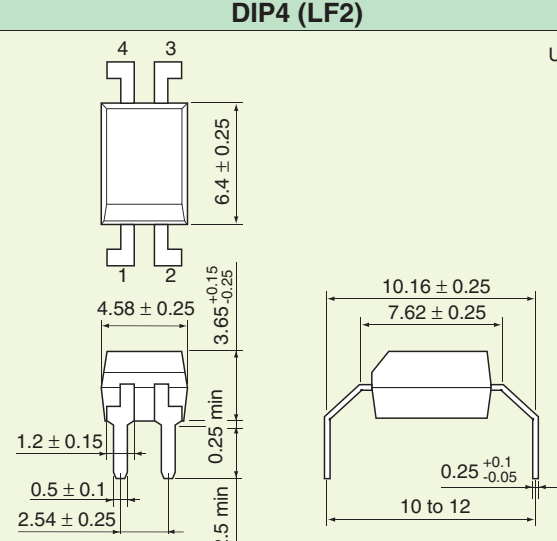
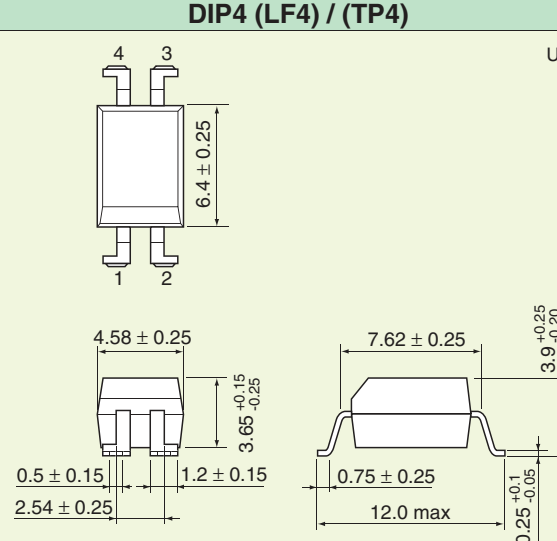
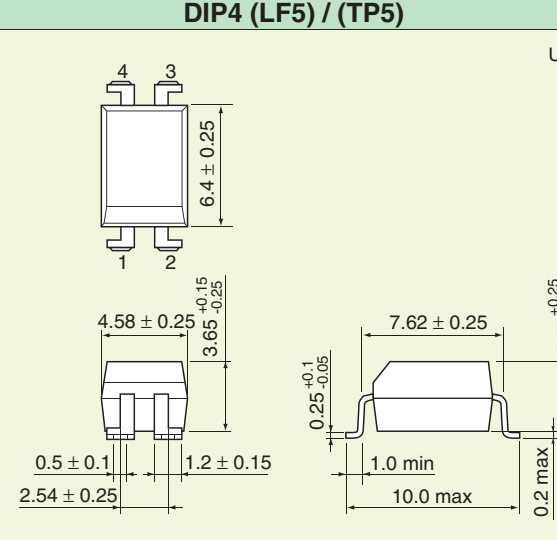
Standard	DIP4	DIP4 (LF1) / (TP1)	DIP4 (LF2)	DIP4 (LF4) / (TP4)	DIP4 (LF5) / (TP5)
 <p>Unit: mm</p>	 <p>Unit: mm</p>	 <p>Unit: mm</p>	 <p>Unit: mm</p>	 <p>Unit: mm</p>	

6 Package Information

2 Package Dimensions (6-Pin DIP)

Standard	DIP6 (LF1) / (TP1)
<p style="text-align: center;">DIP6</p> <p style="text-align: right;">Unit: mm</p>	<p style="text-align: right;">Unit: mm</p>
<p style="text-align: center;">DIP6 (LF2)</p> <p style="text-align: right;">Unit: mm</p>	<p style="text-align: right;">Unit: mm</p>
<p style="text-align: center;">DIP6 (LF5) / (TP5)</p> <p style="text-align: right;">Unit: mm</p>	

2 Package Dimensions (8-Pin DIP)

Standard	DIP8 (LF1) / (TP1)
<p style="text-align: right;">Unit: mm</p>	<p style="text-align: right;">Unit: mm</p>
DIP8 (LF2)	DIP8 (LF4) / (TP4)
<p style="text-align: right;">Unit: mm</p>	<p style="text-align: right;">Unit: mm</p>
DIP8 (LF5) / (TP5)	
<p style="text-align: right;">Unit: mm</p>	

6 Package Information

2 Package Dimensions (Other DIP Packages)

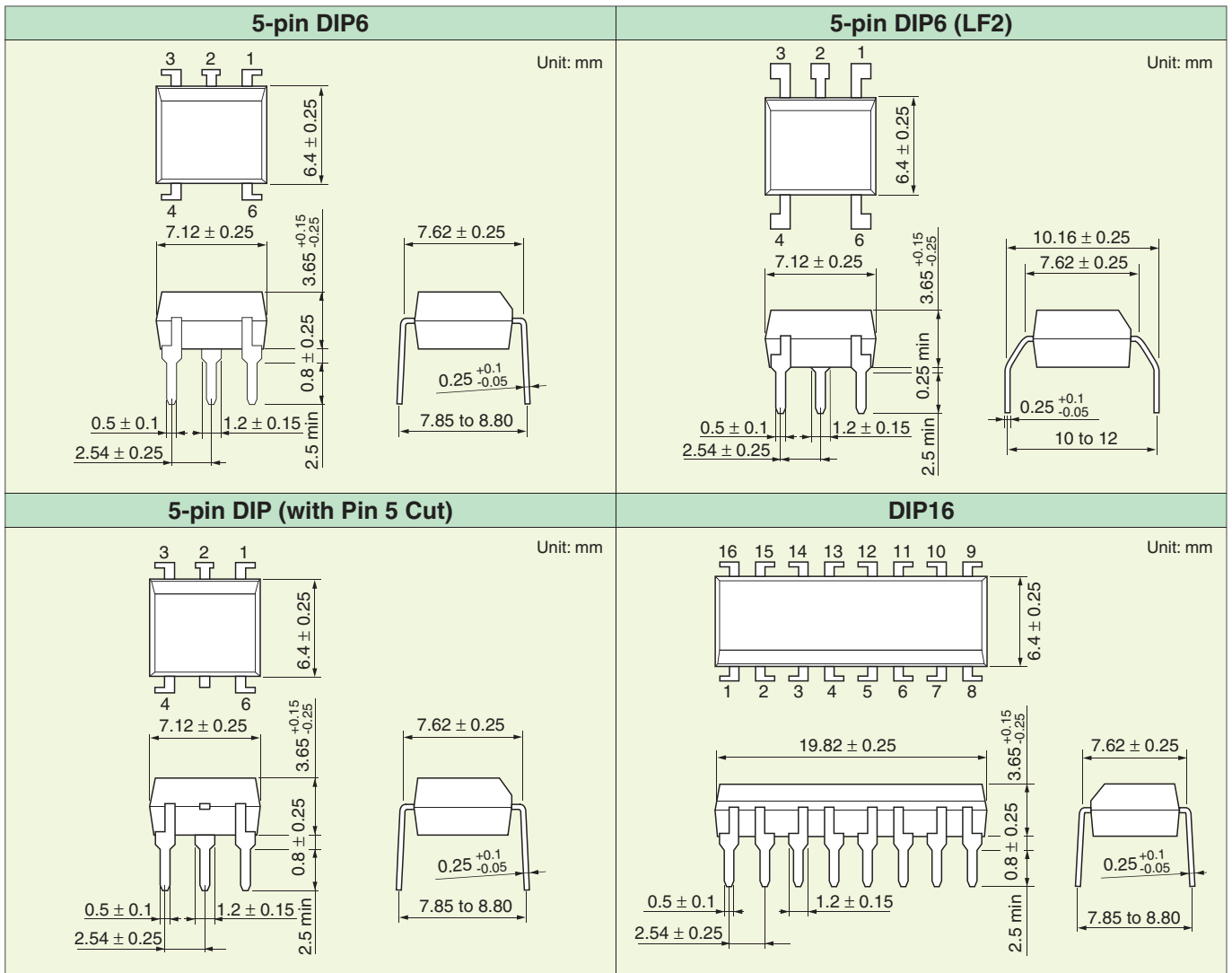

2 Package Dimensions (Surface Mount)

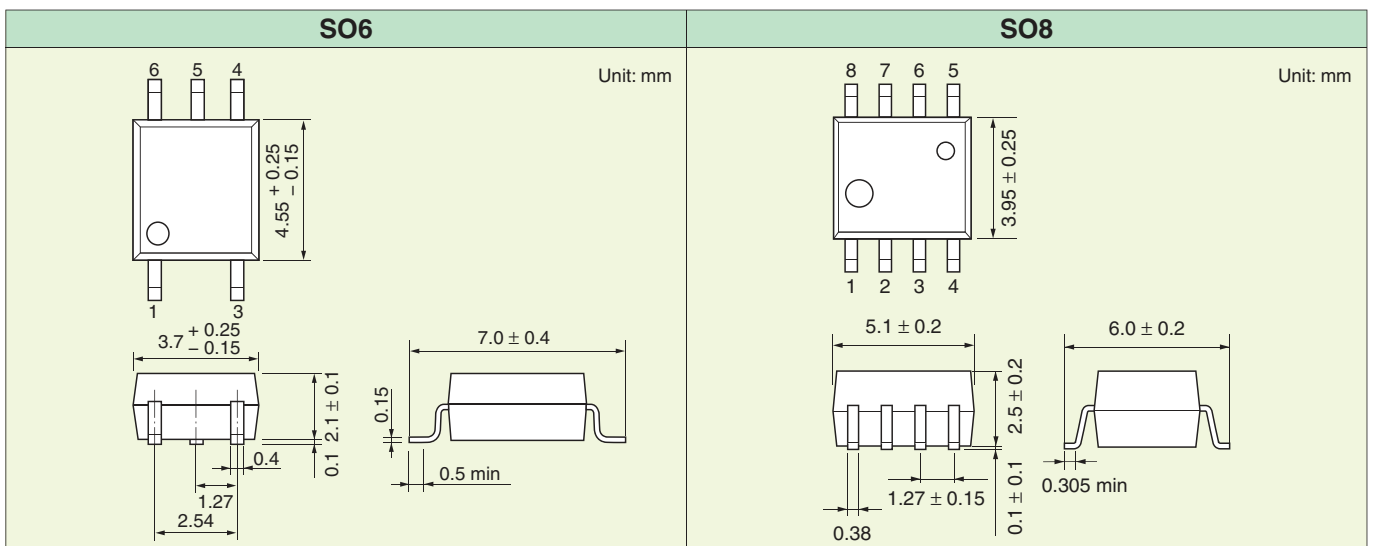

2 Package Dimensions (Surface Mount) (Continued)

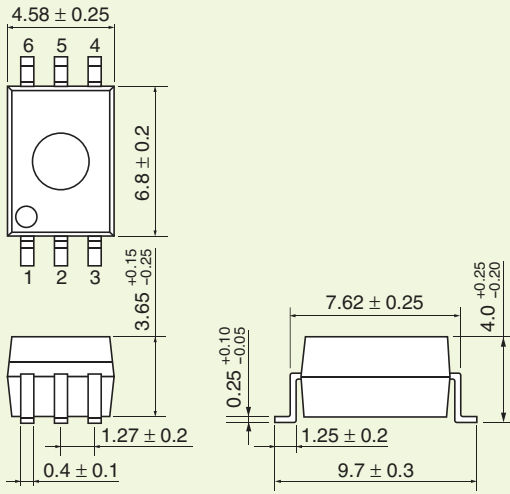
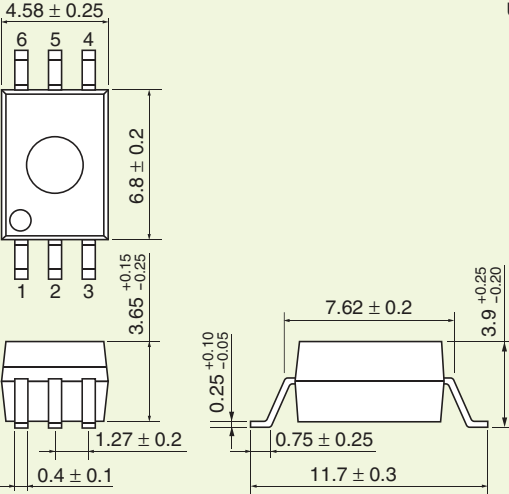
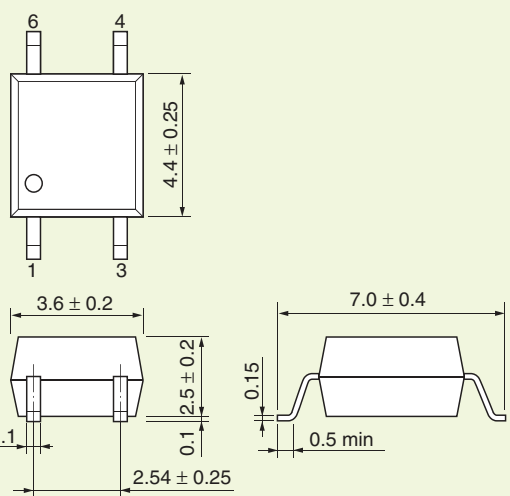
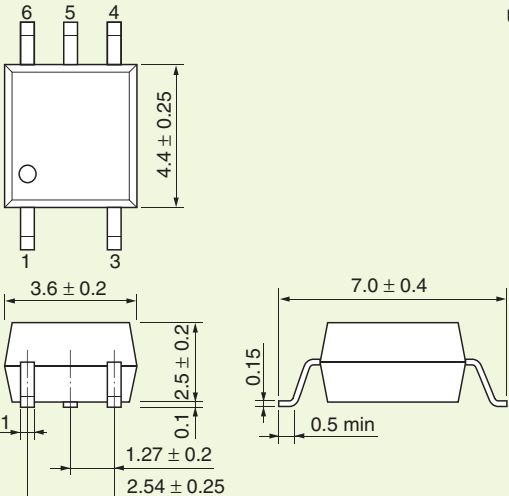
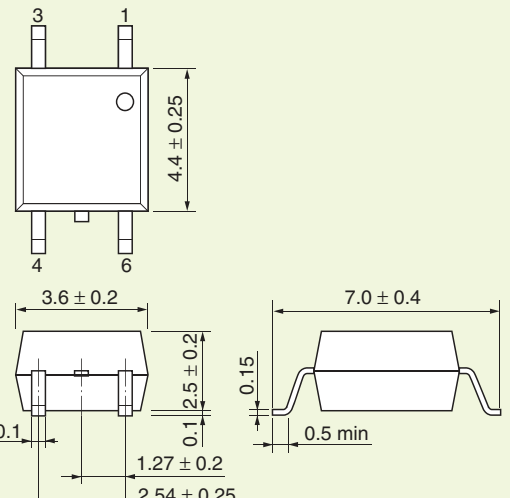
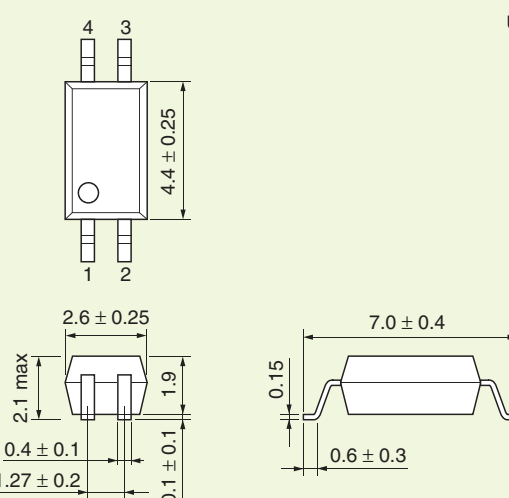
SDIP6	SDIP6 (F type)
 <p>Unit: mm</p>	 <p>Unit: mm</p>
4-pin MFSOP6	5-pin MFSOP6
 <p>Unit: mm</p>	 <p>Unit: mm</p>
4-pin MFSOP6 (with Pin 5 Cut)	SOP4
 <p>Unit: mm</p>	 <p>Unit: mm</p>

6 Package Information

2 Package Dimensions (Surface Mount) (Continued)

<p align="center">2.54SOP4</p> <p align="right">Unit: mm</p>	<p align="center">2.54SOP6</p> <p align="right">Unit: mm</p>
<p align="center">2.54SOP8</p> <p align="right">Unit: mm</p>	<p align="center">SOP16</p> <p align="right">Unit: mm</p>
<p align="center">SSOP4</p> <p align="right">Unit: mm</p> <p align="center">Unless Otherwise Specified, Tolerance ± 0.1 mm</p>	<p align="center">USOP4</p> <p align="right">Unit: mm</p> <p align="center">Unless Otherwise Specified, Tolerance ± 0.2 mm</p>

3 Rank Marking

Transistor-output photocouplers are ranked according to their CTR ranges, whereas thyristor-output and triac-output photocouplers are ranked according to their maximum I_{FT} value. The following gives the rank classifications and rank marks printed on packages. Note that the rank classifications differ from product to product. For details, please refer to the relevant technical datasheets.

1. CTR Rank Name and Rank Marking

Available CTR Rank Selection (○: Available, △: Contact Toshiba)

Part Number	Rank Name									Rank Marking Group
	None	GB	Y	GR	BL	YH	GRL	GRH	BLL	
TLP180	○	○	△	○	△					①
TLP181	○	○	○	○	○	△	△	△	△	②
TLP280	○	○	△	○	△					①
TLP280-4	○	○								③
TLP281	○	○	○	○	○	△	△	△	△	①
TLP281-4	○	○								③
TLP531/532	○	○	△	○	△					①
TLP620	○	○	△	○	△					①
TLP620-2	○	○								③
TLP620-4	○	○								③
TLP630	○	○	△	○	△					①
TLP631/632	○	○	△	○	△					②
TLP731/732	○	○	△	○	△					②
TLP733F/734F	○	○	△	○	△					②

Rank Name	CTR	CTR Rank	
		Other than TLP421	TLP421
None	50 to 600%	*See the right-side tables	Blank, Y, Y+, YE, G, G+, GR, B, B+, BL, GB
Y	50 to 150%	YE	YE
GR	100 to 300%	GR	GR
GB	100 to 600%	GB	GB
BL	200 to 600%	BL	BL
GRL	100 to 200%	G	G
GRH	150 to 300%	G [■]	G+

* Part Marking when No CTR Rank Is Specified

Part Number	None	Rank Marking Group	Part Number	None	Rank Marking Group
TLP180	Blank, YE, GR, BL, GB	①	TLP280-4	Blank, GB	③
TLP280					
TLP531/532					
TLP630					
TLP181	Blank, Y, Y [■] , YE, G, G [■] , GR, B, B [■] , BL, GB	②			
TLP281					
TLP531					
TLP621					
TLP631					
TLP632					
TLP731					
TLP732					
TLP733F					
TLP734F					

6 Package Information

2. LED Trigger Current (IFT) Ranking and Marking

Rank Name	IFT	IFT Rank Marking
None	IFT max	Blank, T7, T5
IFT7	7 mA max	T7, T5
IFT5	5 mA max	T5
IFT2	2 mA max	T2 (only for photorelays)

3. Marking Examples

(a) 4-pin mini-flat 1-channel type

T or f
 Lot No.
 P
 CTR or IFT rank marking
 Pin No. 1

(Example: **TLP626: P626**
TLP620: P620
TLP181: P181 **TLP620**)

(b) TLP421, TLP421F

Pin No. 1
 Lot No. (Monthly code)
 P 4 2 1 F
 Lot No.
 CTR rank marking

(c) TLP280, TLP281

Pin No. 1
 CTR rank marking
 P280
 Lot No.

(d) Others

T or f
 Lot No.
 TLP
 CTR or IFT rank marking
 Pin No. 1

(Examples: **TLP620: TLP620**
TLP666GF: TLP666GF **TLP620**)

Note: When ordering a standard photocoupler, add a CTR or IFT rank in parentheses to the standard part number.

Examples: **TLP181(GB)** **TLP532(GR)**

Use the standard part number when applying for safety standard approval.

Example $\frac{\text{Part number}}{\text{TLP181(GB)}} \rightarrow \frac{\text{Use this part number}}{\text{TLP181}}$

7 Packing Information

1 Photocoupler Magazine Packing Specifications

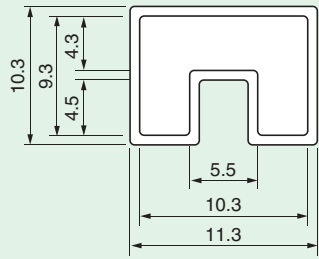
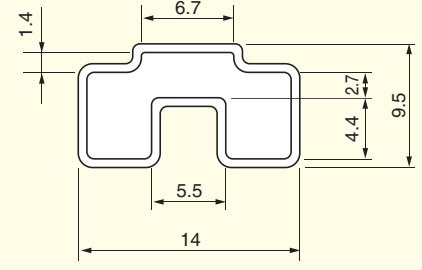
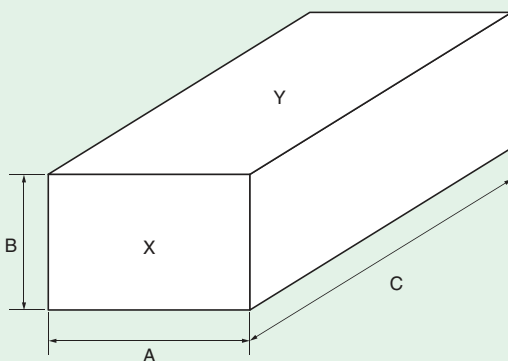
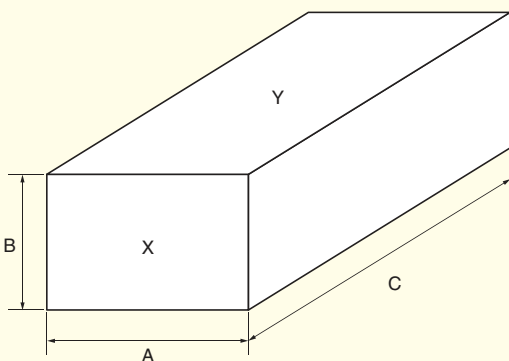
	Standard DIP	DIPs with LF1, LF2, LF4 and LF5 Lead Forming																					
Magazine Dimensions	<p>Unit: mm</p>  <p>Length = 525 Thickness = 0.5</p>	<p>Unit: mm</p>  <p>Length = 525 Thickness = 0.5</p>																					
Device Quantities per Magazine	<table border="1"> <thead> <tr> <th>Package Pin Count</th> <th>4</th> <th>6</th> <th>8</th> <th>12</th> <th>16</th> </tr> </thead> <tbody> <tr> <td>Quantity (pcs)</td> <td>100</td> <td>50</td> <td>50</td> <td>25</td> <td>25</td> </tr> </tbody> </table>						Package Pin Count	4	6	8	12	16	Quantity (pcs)	100	50	50	25	25					
Package Pin Count	4	6	8	12	16																		
Quantity (pcs)	100	50	50	25	25																		
Packing Dimensions	 <table border="1"> <thead> <tr> <th>Number of Magazines</th> <th>Dimensions (A x B x C)</th> <th>Label Position</th> </tr> </thead> <tbody> <tr> <td>4</td> <td>50 x 12 x 531</td> <td>Y</td> </tr> <tr> <td>20</td> <td>67 x 51 x 559</td> <td>Y</td> </tr> <tr> <td>60</td> <td>123 x 76 x 568</td> <td>X</td> </tr> </tbody> </table>	Number of Magazines	Dimensions (A x B x C)	Label Position	4	50 x 12 x 531	Y	20	67 x 51 x 559	Y	60	123 x 76 x 568	X	 <table border="1"> <thead> <tr> <th>Number of Magazines</th> <th>Dimensions (A x B x C)</th> <th>Label Position</th> </tr> </thead> <tbody> <tr> <td>4</td> <td>60 x 13 x 531</td> <td>Y</td> </tr> <tr> <td>40</td> <td>135 x 58 x 568</td> <td>X</td> </tr> </tbody> </table>	Number of Magazines	Dimensions (A x B x C)	Label Position	4	60 x 13 x 531	Y	40	135 x 58 x 568	X
Number of Magazines	Dimensions (A x B x C)	Label Position																					
4	50 x 12 x 531	Y																					
20	67 x 51 x 559	Y																					
60	123 x 76 x 568	X																					
Number of Magazines	Dimensions (A x B x C)	Label Position																					
4	60 x 13 x 531	Y																					
40	135 x 58 x 568	X																					

7 Packing Information

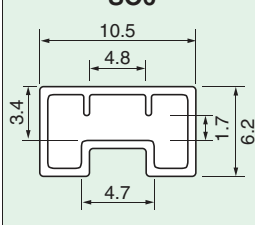
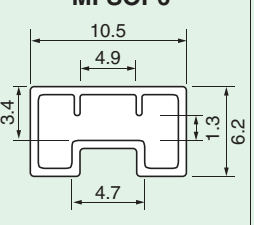
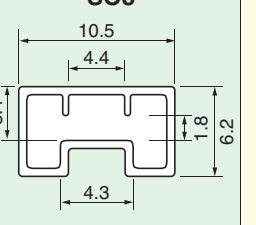
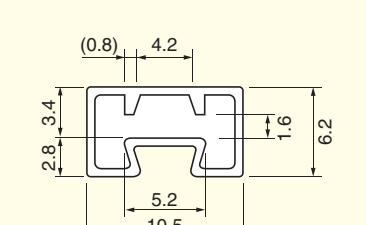
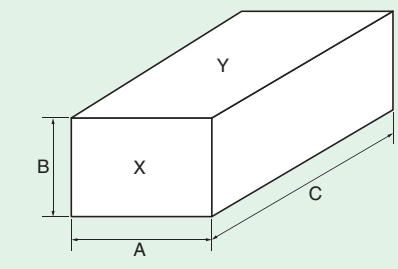
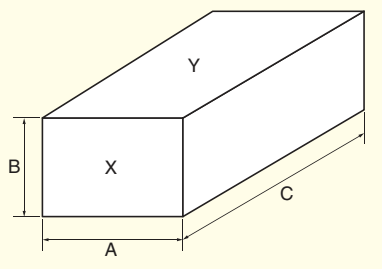
	Mini-Flat Coupler (MFP)			SOP Photocoupler																																		
Magazine Dimensions	<p>Unit: mm</p> <p>SO6</p>  <p>Length = 555 Thickness = 0.5</p>	<p>Unit: mm</p> <p>MFSOP6</p>  <p>Length = 555 Thickness = 0.5</p>	<p>Unit: mm</p> <p>SO8</p>  <p>Length = 555 Thickness = 0.5</p>	<p>Unit: mm</p>  <p>Length = 555 Thickness = 0.5</p>																																		
Device Quantities per Magazine	<table border="1"> <tr> <td>Package Pin Count</td> <td>5 (SO6)</td> </tr> <tr> <td>Quantity (pcs)</td> <td>125</td> </tr> </table>	Package Pin Count	5 (SO6)	Quantity (pcs)	125	<table border="1"> <tr> <td>Package Pin Count</td> <td>4 (MFSOP6)</td> </tr> <tr> <td>Quantity (pcs)</td> <td>150</td> </tr> </table>	Package Pin Count	4 (MFSOP6)	Quantity (pcs)	150	<table border="1"> <tr> <td>Package Pin Count</td> <td>8 (SO8)</td> </tr> <tr> <td>Quantity (pcs)</td> <td>100</td> </tr> </table>	Package Pin Count	8 (SO8)	Quantity (pcs)	100	<table border="1"> <tr> <td>Package Pin Count</td> <td>4 (SOP4)</td> <td>16 (SOP16)</td> </tr> <tr> <td>Quantity (pcs)</td> <td>150</td> <td>50</td> </tr> </table> <table border="1"> <tr> <td>Package Pin Count</td> <td>4 (2.54SOP4)</td> <td>6 (2.54SOP6)</td> <td>8 (2.54SOP8)</td> </tr> <tr> <td>Quantity (pcs)</td> <td>100</td> <td>75</td> <td>50</td> </tr> </table>	Package Pin Count	4 (SOP4)	16 (SOP16)	Quantity (pcs)	150	50	Package Pin Count	4 (2.54SOP4)	6 (2.54SOP6)	8 (2.54SOP8)	Quantity (pcs)	100	75	50								
Package Pin Count	5 (SO6)																																					
Quantity (pcs)	125																																					
Package Pin Count	4 (MFSOP6)																																					
Quantity (pcs)	150																																					
Package Pin Count	8 (SO8)																																					
Quantity (pcs)	100																																					
Package Pin Count	4 (SOP4)	16 (SOP16)																																				
Quantity (pcs)	150	50																																				
Package Pin Count	4 (2.54SOP4)	6 (2.54SOP6)	8 (2.54SOP8)																																			
Quantity (pcs)	100	75	50																																			
Packing Dimensions	 <table border="1"> <thead> <tr> <th>Package</th> <th>Number of Magazines</th> <th>Dimensions (A x B x C)</th> <th>Label Position</th> </tr> </thead> <tbody> <tr> <td>SO6</td> <td>40</td> <td>70 x 55 x 585</td> <td>X</td> </tr> <tr> <td rowspan="3">MFSOP6</td> <td>4</td> <td>29 x 13 x 563</td> <td>Y</td> </tr> <tr> <td>24</td> <td>77 x 31 x 586</td> <td>Y</td> </tr> <tr> <td>40</td> <td>67 x 55 x 586</td> <td>X</td> </tr> <tr> <td>SO8</td> <td>24</td> <td>75 x 29 x 579</td> <td>X</td> </tr> </tbody> </table>			Package	Number of Magazines	Dimensions (A x B x C)	Label Position	SO6	40	70 x 55 x 585	X	MFSOP6	4	29 x 13 x 563	Y	24	77 x 31 x 586	Y	40	67 x 55 x 586	X	SO8	24	75 x 29 x 579	X	 <table border="1"> <thead> <tr> <th>Number of Magazines</th> <th>Dimensions (A x B x C)</th> <th>Label Position</th> </tr> </thead> <tbody> <tr> <td>4</td> <td>29 x 13 x 563</td> <td>Y</td> </tr> <tr> <td>24</td> <td>77 x 31 x 586</td> <td>Y</td> </tr> <tr> <td>40</td> <td>67 x 55 x 586</td> <td>X</td> </tr> </tbody> </table>	Number of Magazines	Dimensions (A x B x C)	Label Position	4	29 x 13 x 563	Y	24	77 x 31 x 586	Y	40	67 x 55 x 586	X
Package	Number of Magazines	Dimensions (A x B x C)	Label Position																																			
SO6	40	70 x 55 x 585	X																																			
MFSOP6	4	29 x 13 x 563	Y																																			
	24	77 x 31 x 586	Y																																			
	40	67 x 55 x 586	X																																			
SO8	24	75 x 29 x 579	X																																			
Number of Magazines	Dimensions (A x B x C)	Label Position																																				
4	29 x 13 x 563	Y																																				
24	77 x 31 x 586	Y																																				
40	67 x 55 x 586	X																																				

Photocoupler Package Type	Typical Devices
MFSOP6	TLP160J, TLP180, TLP190B
SO6	TLP104, TLP109, TLP116A
SO8	TLP2105, TLP2108, TLP2116, TLP2118E, TLP2405, TLP2408
SOP4	TLP280, TLP281
SOP16	TLP280-4, TLP281-4, TLP270D, TLP270G
2.54SOP4	TLP176G, TLP176A
2.54SOP6	TLP197G
2.54SOP8	TLP206G, TLP206A

2 Tape-and-Reel Specifications

The tape specifications differ for photocouplers manufactured in Thailand.

1. Embossed Tape Specifications for Surface-Mount Lead Form Options

Photocoupler Package Types	Tape Option Symbol	Typical Devices
MFSOP6, SO6	(TPL) or (TPR)	TLP165J, TLP181, TLP190B
SO8	(TP)	TLP2105, TLP2108, TLP2405, TLP2408
SOP4	(TP)	TLP280, TLP281
SOP16	(TP)	TLP280-4, TLP281-4
2.54SOP4	(TP)	TLP176G, TLP176A, TLP176D
2.54SOP6	(TP)	TLP197G
2.54SOP8	(TP)	TLP200D, TLP206A, TLP206G
SSOP4	(TP15)	TLP3212 to 3217, TLP3230 to TLP3250
SDIP6	(TP)	TLP701, TLP705, TLP719
DIP(LF1, LF5)	(TP1) or (TP5)	TLP550, TLP560G
DIP(LF4)	(TP4)	TLP560G

2. Tape Dimensions

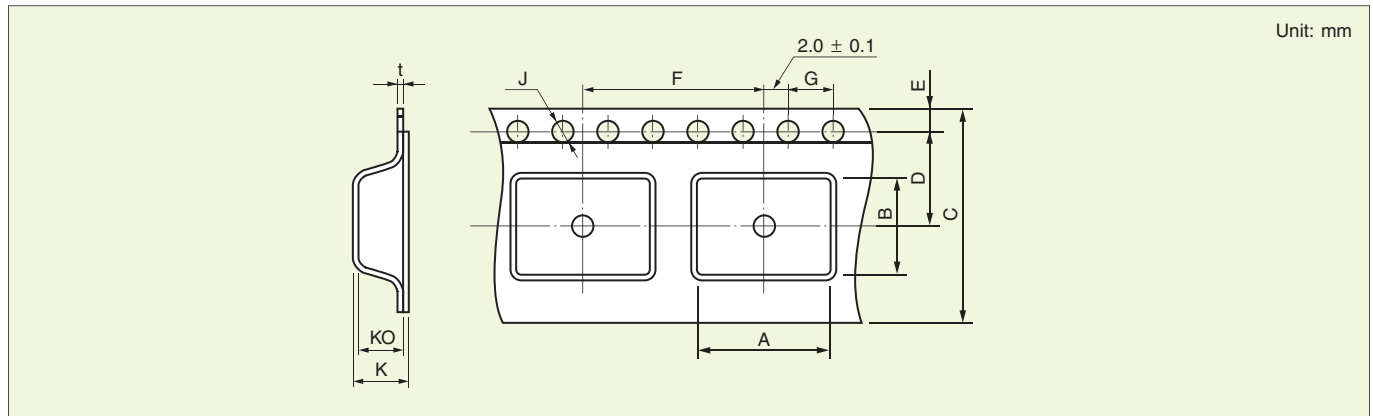

Unit: mm

Photocoupler Package Type	MFSOP6	SO6	SO8	SOP4	SOP16	2.54SOP4	2.54SOP6	2.54SOP8	SSOP4	SDIP6	SDIP6 F type	DIP(LF1, LF5)	DIP(LF4)	
Tape Option	(TPL), (TPR)	(TPL), (TPR)	(TP)	(TP)	(TP)	(TP)	(TP)	(TP)	(TP15)	(TP)	(TP)	(TP1), (TP5)	(TP4)	
Symbol (See figure above)	A	4.2 ± 0.1	4.0 ± 0.1	6.5 ± 0.1	3.1 ± 0.1	7.5 ± 0.1	4.3 ± 0.1	7.5 ± 0.1	2.35 ± 0.2	10.4 ± 0.1	12.3 ± 0.1	10.4 ± 0.1	12.3 ± 0.1	
	B	7.6 ± 0.1		5.6 ± 0.1	7.5 ± 0.1	10.5 ± 0.1	7.5 ± 0.1	6.7 ± 0.1	10.5 ± 0.1	4.5 ± 0.1	5.1 ± 0.1		*1	*1
	C	12.0 ± 0.3				16.0 ± 0.3	12.0 ± 0.3	16.0 ± 0.3	12.0 ± 0.3	16.0 ± 0.3				
	D	5.5 ± 0.1				7.5 ± 0.1	5.5 ± 0.1	7.5 ± 0.1	5.5 ± 0.1	7.5 ± 0.1				
	E	1.75 ± 0.1												
	F	8.0 ± 0.1				12.0 ± 0.1	8.0 ± 0.1	12.0 ± 0.1	4.0 ± 0.1	12.0 ± 0.1	16.0 ± 0.1	12.0 ± 0.1	16.0 ± 0.1	
	G	4.0 ± 0.1												
	J	1.5 ^{+0.1} ₋₀												
	K	3.15 ± 0.2	2.9 ± 0.2	3.4 ± 0.2	2.5 ± 0.2	2.4 ± 0.2	2.6 ± 0.2	2.5 ± 0.2	2.4 ± 0.2	2.4 ± 0.2	4.55 ± 0.2			
	KO	2.8 ± 0.1	2.6 ± 0.1	3.1 ± 0.1	2.3 ± 0.1	2.2 ± 0.1	2.4 ± 0.1	2.3 ± 0.1	2.2 ± 0.1	2.1 ± 0.1	4.1 ± 0.1			
	t	0.3 ± 0.05										0.4 ± 0.05		

*1: Typical devices

DIP4	TLP620	5.1 ± 0.1
DIP6 (short package)	TLP631, TLP734, TLP747G	7.6 ± 0.1
DIP8	TLP555, TLP2601	10.1 ± 0.1 (TP4) is not available

7 Packing Information

3. Reel Dimensions

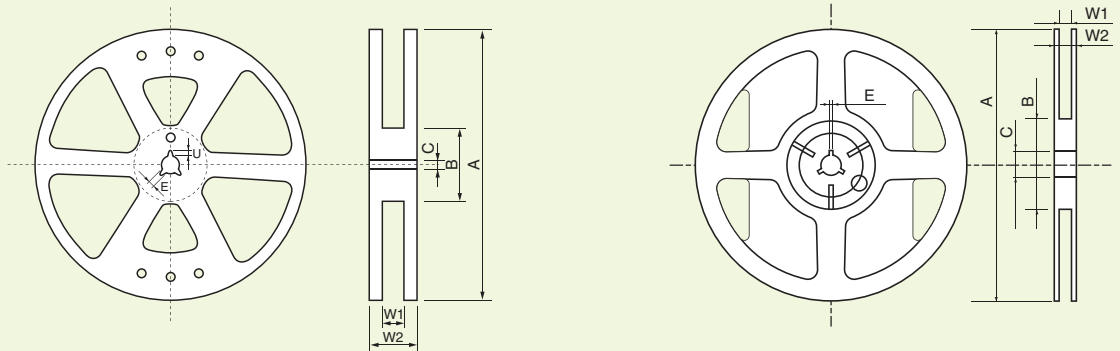

ø380 mm

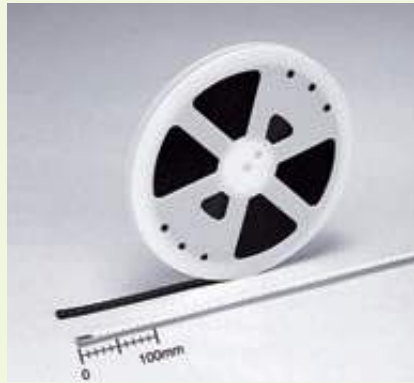

ø330 mm



ø180 mm

Unit: mm

Photocopier Package Type	MFSOP, S06	SO8	SOP4	SOP16	2.54SOP4	2.54SOP6	2.54SOP8	SSOP4	SDIP6	SDIP6 F type	DIP(LF1, LF5)	DIP(LF4)
Tape Option	(TPL), (TPR)	(TP)	(TP)	(TP)	(TP)			(TP15)	(TP)	(TP)	(TP1), (TP5)	(TP4)
Symbol (See figure above)	A	ø380 ± 2		ø330 ± 2				180 ⁺⁰ ₋₄	ø380 ± 2			
	B			ø80 ± 1				ø60	ø80 ± 1			
	C			ø13 ± 0.5				ø13	ø13 ± 0.5			
	E			2.0 ± 0.5				2 ± 0.5	2.0 ± 0.5			
	U			4.0 ± 0.5				4.0 ± 0.5	4.0 ± 0.5			
	W1	13.5 ± 0.5		17.5 ± 0.5	13.5 ± 0.5	17.5 ± 0.5		13 ± 0.3	17.5 ± 0.5			
	W2	17.5 ± 1.0		21.5 ± 1.0	17.5 ± 1.0	21.5 ± 1.0		15.4 ± 1.0	21.5 ± 1.0			

Photocopiers Manufactured in Thailand

Photocopier Package Type	MFSOP	DIP6(LF1,LF5,LF4)	DIP4(LF1,LF5,LF4)	DIP8(LF1,LF5)	
Tape Option	(TPL), (TPR)	(TP1), (TP5), (TP4)	(TP1), (TP5), (TP4)	(TP1), (TP5)	
Symbol (See figure above)	A	ø380 ± 2		ø330 ± 2	
	B	ø80 ± 1			
	C	ø13 ± 0.5			
	E	2.0 ± 0.5			
	U	4.0 ± 0.5			
	W1	13.5 ± 0.5	17.5 ± 0.5		
	W2	17.5 ± 1.0	21.5 ± 1.0		

4. Other Packing Information

a) Device orientation on tape

Photocouplers are oriented in cavity, as shown below.

Photocoupler Package Type	Tape Option
MFSOP6, SO6	TPR

A)

Photocoupler Package Type	Tape Option
MFSOP6, SO6	TPL
SOP4, 2.54SOP4	TP
SSOP4	TP15

B)

Photocoupler Package Type	Tape Option
SOP16, SO8	TP
2.54SOP6/8	TP
SDIP6	TP
DIP(LF1, LF5)	TP1, TP5
DIP(LF4)	TP4

C)

b) Tape Specifications

Quantities Per Reel

Photocoupler Package Type	MFSOP6, SO6	SOP4, SO8	SOP16	2.54SOP4/6/8	SSOP4	SDIP6	SDIP6 F type	DIP(LF1, LF5)	DIP(LF4)
Quantity (pcs)	3000	2500	2500	2500	1500	1500	1000	1500	1000

Photocouplers Manufactured in Thailand

Photocoupler Package Type	MFSOP	DIP4/6(LF1,LF5)	DIP4/6(LF4)	DIP8(LF1,LF5)
Quantity (pcs)	3000	1500	1000	1000

Empty Cavities

Item	Specification	Note
Consecutive empty cavities	Zero	Any 40-mm portion of tape except leader and trailer.
Non-consecutive empty cavities	0.2% max/reel *2	Except leader and trailer.

*2: 6 pcs max/reel for DIP and SDIP packages

c) Packing boxes

One or five reels per box
Two or five reels per box for photocouplers manufactured in Thailand

d) Label

The reel label includes the following information:

1. Part number 2. Tape type 3. Quantity 4. Lot number

e) Purchase order

Specify the part number, tape and quantity as follows.

Example TLP181(GB-TPR, F) 3000 units

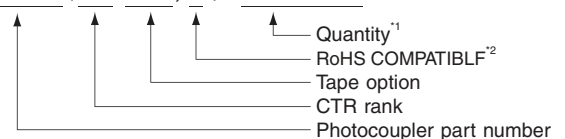

*1: Must be a multiple of the quantity per-reel.

*2: "F" identifies the indication of product Labels with "[G]/RoHS COMPATIBLE".

Please contact your TOSHIBA sales representative for details as to environmental matters such as the RoHS compatibility of Product. The RoHS is the Directive 2002/95/EC of the European Parliament and of the Council of 27 January 2003 on the restriction of the use of certain hazardous substances in electrical and electronic equipment.

8 Board Assembly

1 Example Land Patterns

Below are the example land patterns for surface-mount packages.

Mini-flat and SOP couplers

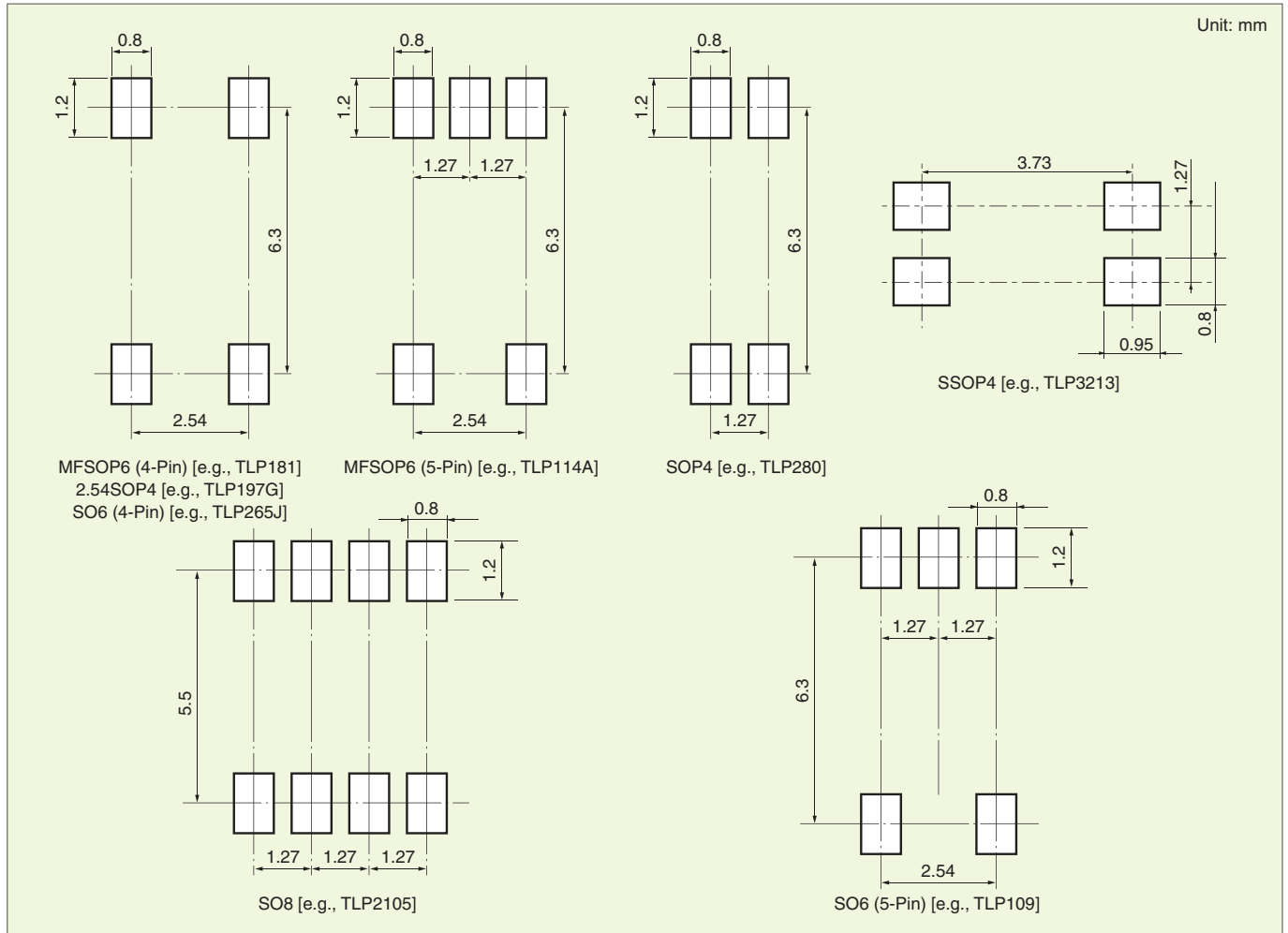

Surface-Mount Lead-Formed Photocouplers

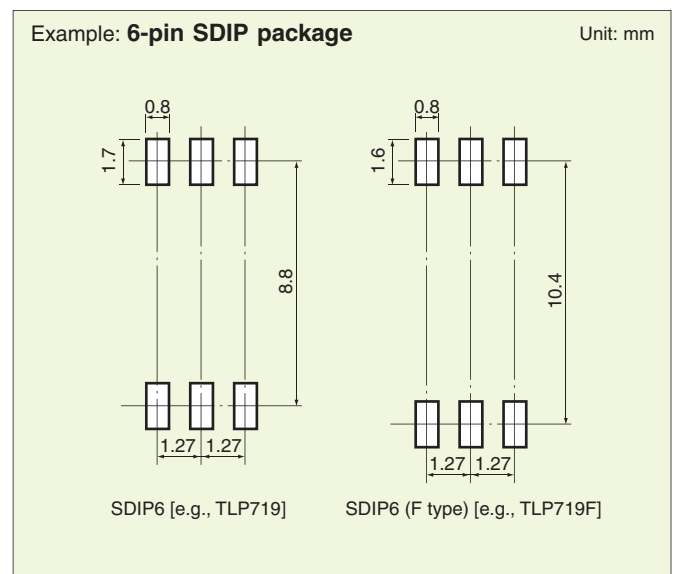
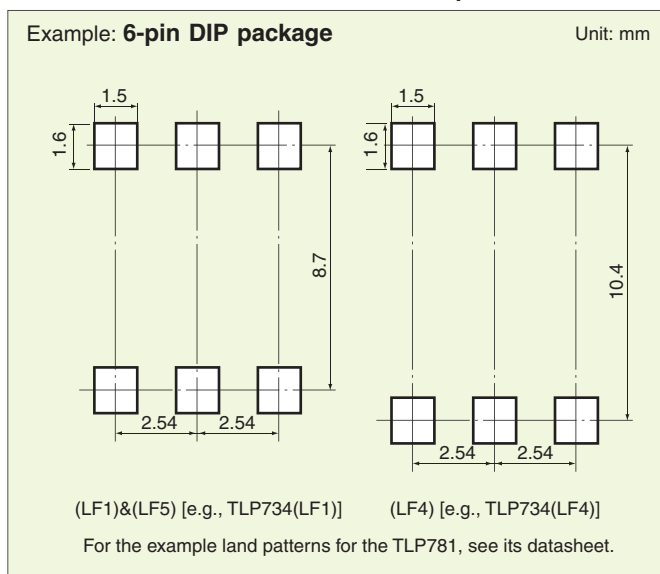

2 Board Assembly Considerations

1. Soldering

When using a soldering iron or medium infrared ray/hot air reflow, avoid a rise in device temperature as much as possible by observing the following conditions.

1.1) Using a soldering iron

- Solder once within 10 seconds for a lead temperature of up to 260°C.
- Solder once within 3 seconds for a lead temperature of up to 350°C.

1.2) Using medium infrared ray/hot air reflow

- Complete the infrared ray/hot air reflow process at once within 30 seconds at a package surface temperature between 210°C and 240°C.
- Example of temperature profile of lead (Pb) solder

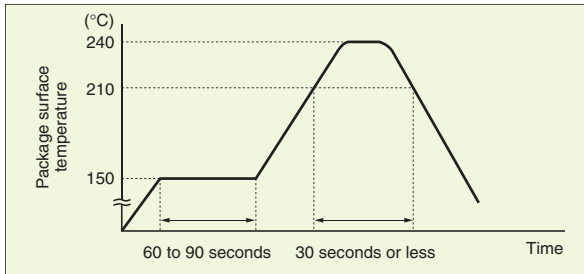

Example of temperature profile of lead (Pb) solder

- Example of temperature profile of lead (Pb)-free solder

The profile below shows only the typical temperature profile and conditions, which might not apply to all Toshiba photocouplers. Temperature profiles and conditions may differ from product to product. Refer to the relevant technical datasheets and databooks when mounting a device.

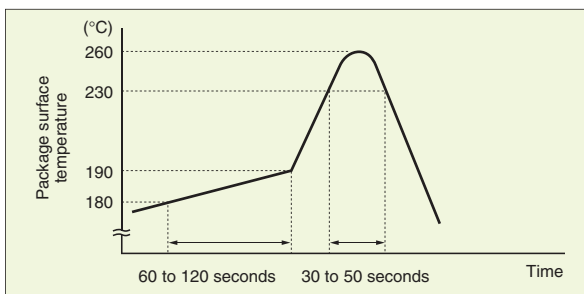

Example of temperature profile of lead (Pb)-free solder

- Precautions for heating

Keeping packages at high temperature for a long period of time can degrade the quality and reliability of devices. Soldering time has to be kept as short as possible to avoid a rise in package temperature.

When using a halogen lamp or infrared heater, avoid direct irradiation of packages, since this may cause a rise in package temperature.

1.3) Dip soldering (flow soldering)

The thermal shock of dip soldering increases thermal stress on devices. To avoid stress, the use of a soldering iron or medium infrared ray/hot air reflow is recommended. If you want to use dip soldering, contact your nearest Toshiba sales representative.

2. Flux Cleaning

- When cleaning circuit boards to remove flux, make sure that no residual reactive ions such as sodium(Na⁺) or chloride(Cl⁻) ions remain. Note that organic solvents react with water to generate hydrogen chloride and other corrosive gases, which can degrade device performance.
- Washing devices with water will not cause any problems. However, make sure that no reactive ions such as sodium(Na⁺) or chloride(Cl⁻) ions are left as residue. Also, be sure to dry devices sufficiently after washing.
- Do not rub device markings with a brush or with your hand during cleaning or while the devices are still wet from the cleaning agent. Doing so can rub off the markings.
- Dip cleaning, shower cleaning and steam cleaning processes all involve the chemical action of a solvent. Use only recommended solvents for these cleaning methods. When immersing devices in a solvent or steam bath, make sure that the temperature of the liquid is 50°C or below and that the circuit board is removed from the bath within one minute.
- If a device package allows ultrasonic cleaning, keep the duration of ultrasonic cleaning as short as possible, since long hours of ultrasonic cleaning degrade the adhesion between the mold resin and the frame material.

The following ultrasonic cleaning conditions are recommended.

Frequency: 27 kHz to 29 kHz

Ultrasonic output power: 300 W or less (0.25 W/cm² or less)

Cleaning time: 30 seconds or less

Suspend the circuit board in the solvent bath during ultrasonic cleaning in such a way that the ultrasonic vibrator does not come into direct contact with the circuit board or the device.

Conventional cleaning solvents that contain freon are not recommended due to its adverse effect on the earth's ozone layer. Alternative freon-free products are available on the market. Some of these alternative cleaning agents are listed in the table below. Contact Toshiba or a Toshiba distributor regarding cleaning conditions and other relevant information for each product type.

Examples of Alternative Cleaning Agents

Technocare	FRW-1, FRW-17, FRV-100	GE Toshiba Silicon
Asahi Clean	AK-225AES	Asahi Glass Co., Ltd
Clean Through	750H	Kao Co., Ltd.
Pine Alpha	ST-100S, ST-100SX	Arakawa Chemical Co., Ltd.

9 Device Degradation

1 Projected Operating Life Based on LED Light Output Degradation

Toshiba photocouplers use one of four types of LEDs and a projection of the operating life has been made for each LED. The table on page 57 shows the types of LED used in photocouplers and the figures on pages 58 to 60 show projections of long-term light output performance and operating life. Note that these operating life data are estimates extrapolated from long-term light output degradation over a single wafer lot and are shown as reference only.

	Projected Operating Life ($T_a = 40^\circ\text{C}$, $I_F = 20\text{ mA}$, failure criteria: degradation rate $\Delta P_o < -50\%$)		Photocouplers
	F50% operating life	F0.1% operating life	
① GaAs LED	1,300,000 h	260,000 h	Mainly for phototransistor output devices and phototriac output devices
② GaAlAs(SH) LED	540,000 h	100,000 h	Mainly for photo-IC couplers
③ GaAlAs(DH) LED	1,000,000 h	200,000 h	Mainly for photorelays (MOSFET output), photovoltaic couplers and photo-IC couplers
④ GaAlAs(MQW) LED	Ask your local Toshiba sales representative.		Mainly for photo-IC couplers

F50% (cumulative failure rate 50%) operating life: Time period until the projected long-term light output degradation curve of the average light output change (\bar{X}) shown on pages 58 to 60 reaches the failure criteria.

F0.1% (cumulative failure rate 0.1%) operating life: Time period until the projected long-term light output degradation curve of $\bar{X} - 3\sigma$ shown on pages 58 to 60 reaches the failure criteria.

The relationship between LED light output degradation and optical coupling characteristics is shown below.

- (1) The relationship between LED light output degradation and current transfer ratio (CTR)/short circuit current (I_{sc}) is 1:1.

$$\frac{\text{CTR}(t)}{\text{CTR}(o)} = \frac{P_o(t)}{P_o(o)}$$

- (2) The relationship between a reciprocal value of LED light output degradation and $I_{FT}/I_{FLH}/I_{FHL}/I_{FH}$ change is 1:1.

$$\frac{I_{FT}(t)}{I_{FT}(o)} = \left(\frac{P_o(t)}{P_o(o)} \right)^{-1}$$

LEDs Used in Photocouplers

LED: ① GaAs LED ② GaAlAs (SH) LED ③ GaAlAs (DH) LED ④ GaAlAs (MQW) LED

Photocouplers	LED	Photocouplers	LED	Photocouplers	LED	Photocouplers	LED	Photocouplers	LED
4N25 (SHORT)	①	TLP160 Series	①	TLP363 Series	①	TLP599 Series	①	TLP2630	②
4N25A (SHORT)	①	TLP161 Series	①	TLP371	①	TLP620 Series	①	TLP2631	②
4N26 (SHORT)	①	TLP163	①	TLP372	①	TLP621 Series	①	TLP3022(S) Series	①
4N27 (SHORT)	①	TLP165J	①	TLP373	①	TLP624 Series	①	TLP3042(S) Series	①
4N28 (SHORT)	①	TLP166J	①	TLP421 Series	①	TLP626 Series	①	TLP3063(S) Series	③
4N29 (SHORT)	①	TLP168J	③	TLP504A	①	TLP627 Series	①	TLP31xx Series	①
4N29A (SHORT)	①	TLP172 Series	①	TLP512	②	TLP628 Series	①	TLP32xx Series	①
4N30 (SHORT)	①	TLP174G	①	TLP513	②	TLP629 Series	①	TLP3230	①
4N31 (SHORT)	①	TLP176 Series	①	TLP521-1	①	TLP630	①	TLP3231	①
4N32 (SHORT)	①	TLP180	①	TLP521-2	①	TLP631	①	TLP3240	③
4N32A (SHORT)	①	TLP181	①	TLP521-4	①	TLP632	①	TLP3241	③
4N33 (SHORT)	①	TLP190B	③	TLP523 Series	①	TLP641 Series	①	TLP3250	③
4N35 (SHORT)	①	TLP191B	③	TLP525G Series	①	TLP651	②	TLP3762(S) Series	①
4N36 (SHORT)	①	TLP192 Series	①	TLP531	①	TLP700	③	TLP3904	①
4N37 (SHORT)	①	TLP197 Series	①	TLP532	①	TLP701	②	TLP3914	③
4N38 (SHORT)	①	TLP200D	①	TLP541G	①	TLP702	②	TLP3924	③
4N38A (SHORT)	①	TLP202 Series	①	TLP542G	①	TLP705	②	TLP4xxx Series	①
6N135	②	TLP206 Series	①	TLP543J	①	TLP706	②	TLP104	④
6N136	②	TLP222 Series	①	TLP545J	①	TLP716	②	TLP118	④
6N137	②	TLP224G Series	①	TLP550	②	TLP719	②	TLP151	④
6N138	②	TLP225A	①	TLP551	②	TLP731	①	TLP350H	④
6N139	②	TLP227 Series	①	TLP552	②	TLP732	①	TLP351H	④
TLP102	②	TLP250 Series	②	TLP553	②	TLP733 Series	①	TLP700H	④
TLP106	②	TLP251 Series	②	TLP554	②	TLP734 Series	①	TLP701H	④
TLP112	②	TLP260J	①	TLP555	②	TLP741 Series	①	TLP708	④
TLP112A	③	TLP270 Series	①	TLP557	②	TLP747 Series	①	TLP714	④
TLP113	②	TLP280 Series	①	TLP558	②	TLP750 Series	②	TLP754	④
TLP114A	③	TLP281 Series	①	TLP559	②	TLP751 Series	②	TLP2168	④
TLP115	②	TLP283 Series	①	TLP560 Series	①	TLP759 Series	②	TLP2368	④
TLP115A	③	TLP296G	①	TLP561 Series	①	TLP762J Series	①	TLP2404	④
TLP116	③	TLP320 Series	①	TLP570	①	TLP763J Series	①	TLP2409	④
TLP117	③	TLP330	①	TLP571	①	TLP797 Series	①	TLP2418	④
TLP124	①	TLP331	①	TLP572	①	TLP798GA	③	TLP2451	④
TLP126	①	TLP332	①	TLP590B	③	TLP2066	③	TLP2468	④
TLP127	①	TLP350	②	TLP591B	③	TLP2200	②	TLP2768	④
TLP130	①	TLP351	②	TLP592 Series	①	TLP2530	②		
TLP131	①	TLP351A	②	TLP594 Series	①	TLP2531	②		
TLP137	①	TLP360 Series	①	TLP597 Series	①	TLP2601	②		
TLP141G	①	TLP361 Series	①	TLP598 Series	③	TLP260J	①		

9 Device Degradation

① GaAs LED Projected Light Output Degradation Data

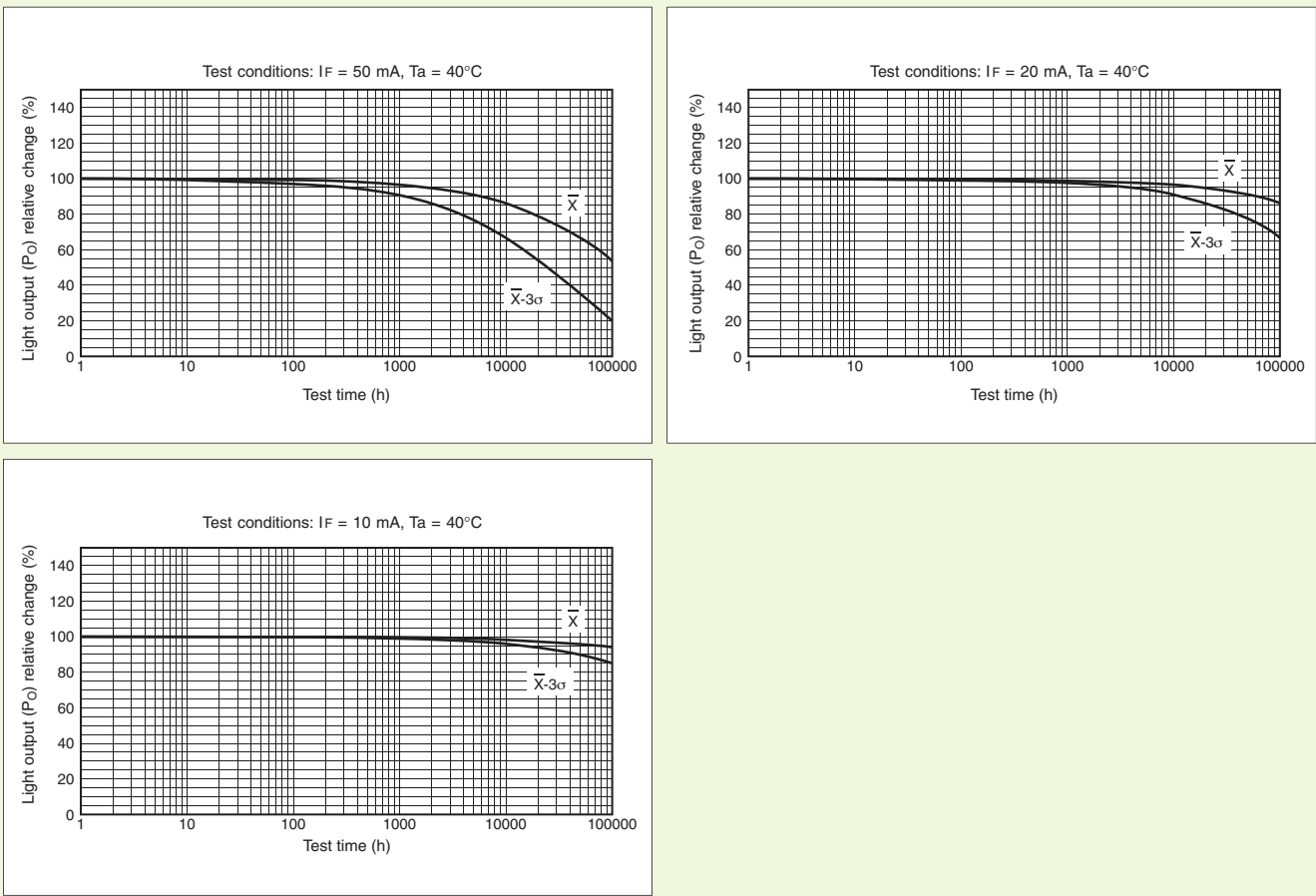

① GaAs LED Projected Operating Life Data

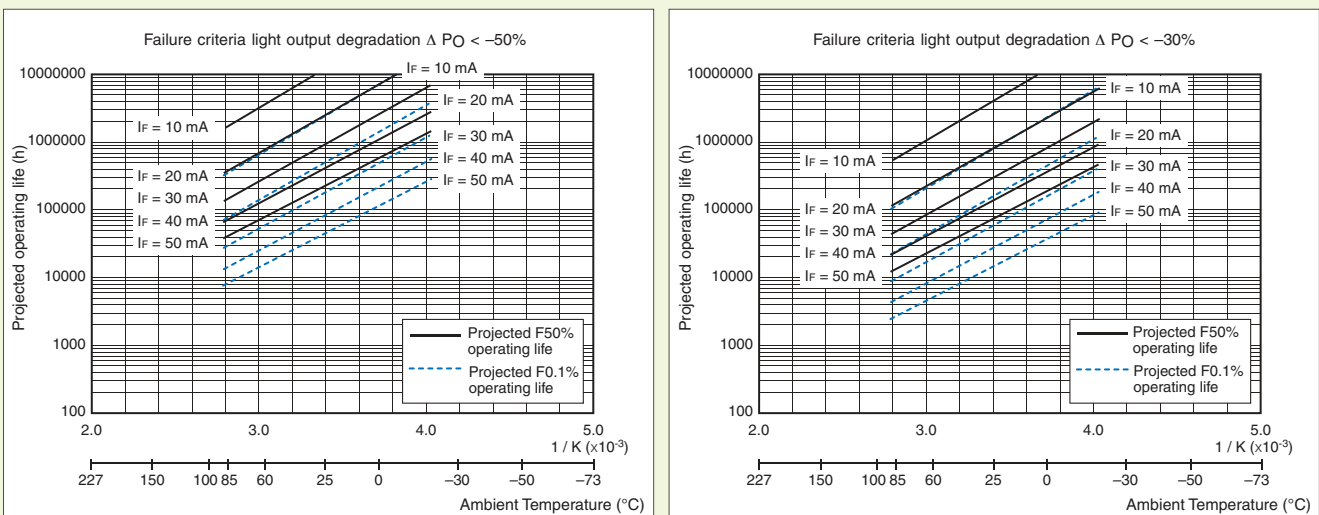

The above operating life data are estimates extrapolated from long-term light output degradation over a single wafer lot and are shown as reference only. Operating conditions exceeding the maximum ratings are not guaranteed.

② GaAlAs (SH) LED Projected Light Output Degradation Data

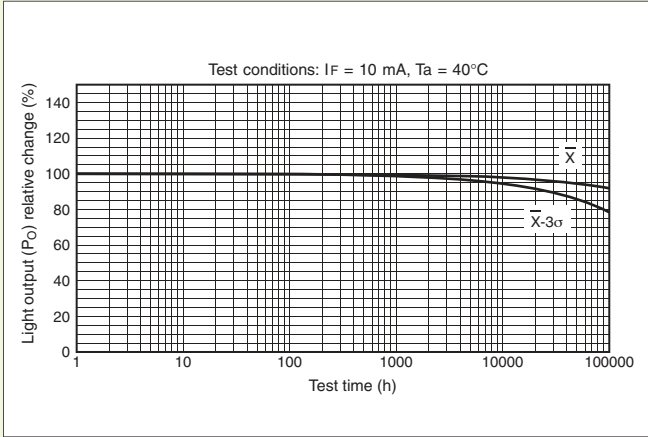
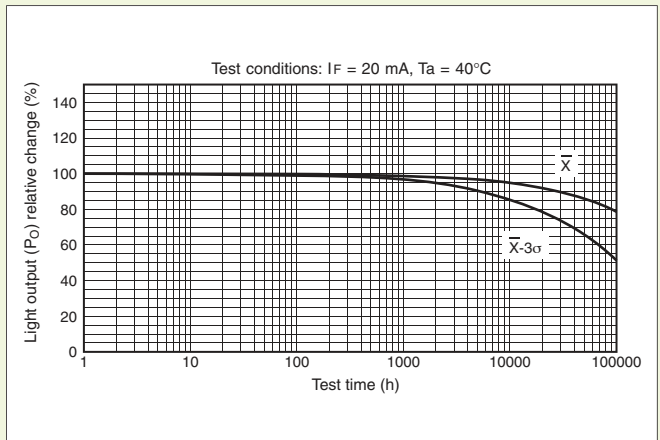
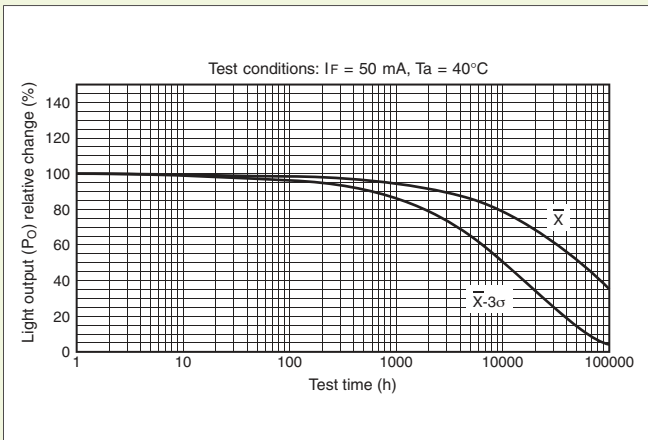

② GaAlAs (SH) LED Projected Operating Life Data

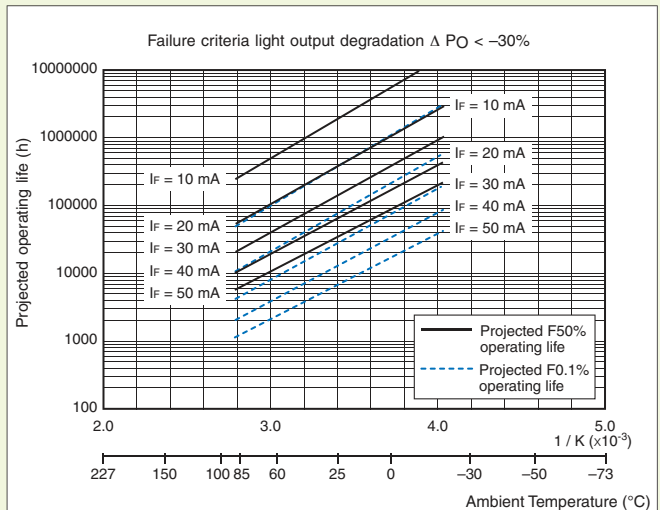
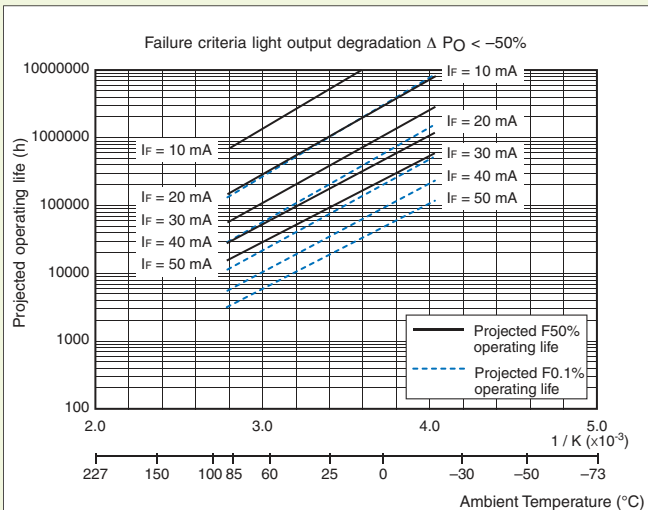

The above operating life data are estimates extrapolated from long-term light output degradation over a single wafer lot and are shown as reference only. Operating conditions exceeding the maximum ratings are not guaranteed.

9 Device Degradation

③ GaAlAs (DH) LED Projected Light Output Degradation Data

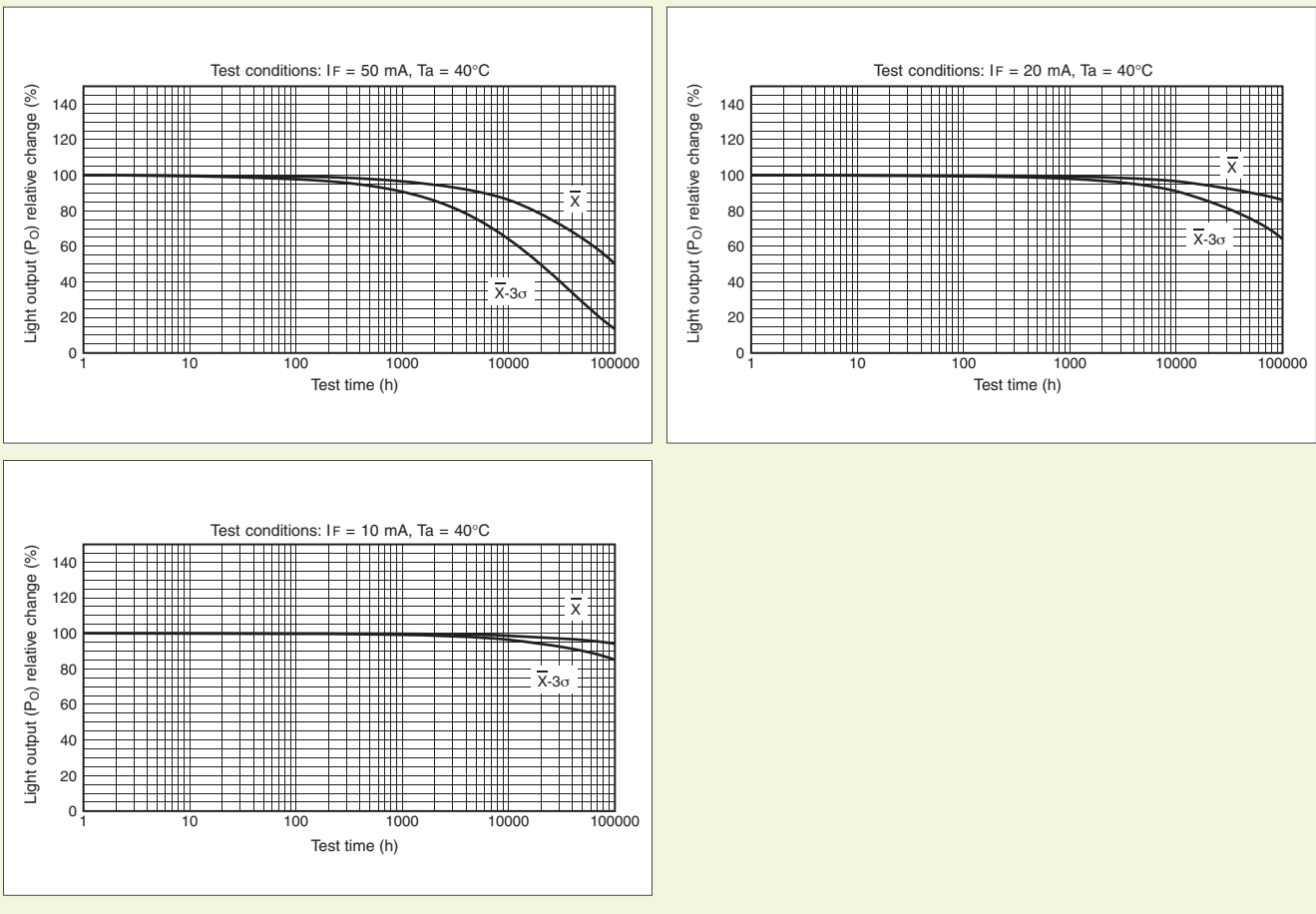

③ GaAlAs (DH) LED Projected Operating Life Data

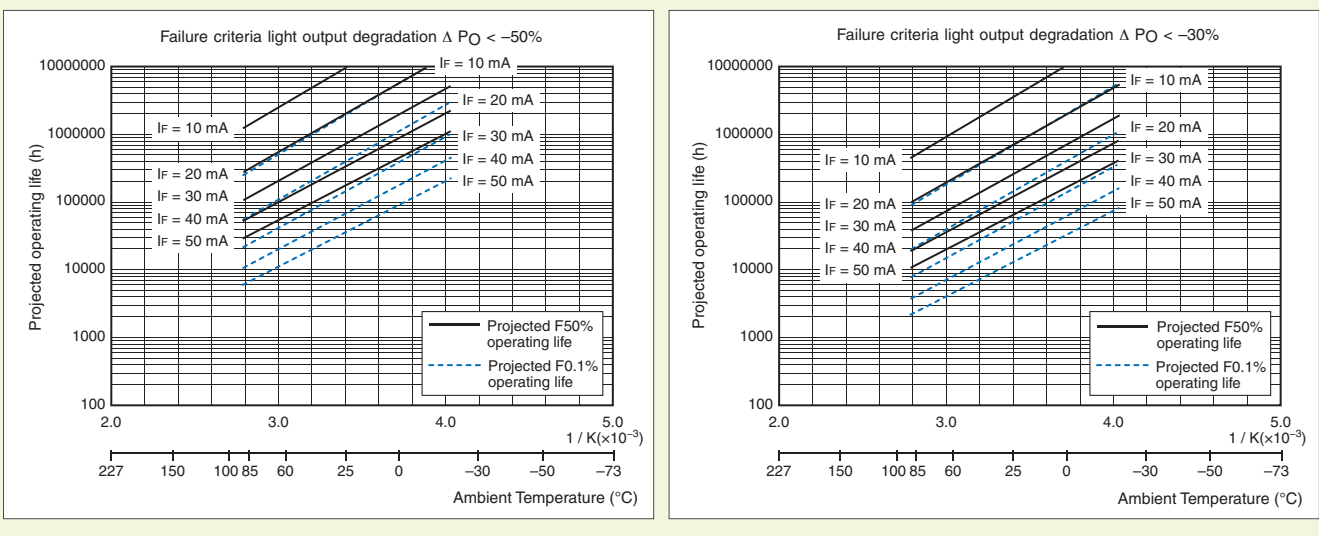

The above operating life data are estimates extrapolated from long-term light output degradation over a single wafer lot and are shown as reference only. Operating conditions exceeding the maximum ratings are not guaranteed.

9 Device Degradation

Reading the Projected LED Operating Life Graph

For example, let's calculate the operating life of the GaAs LED, based on the data shown on page 60.

Here is an example of how to read an operating life, assuming that the ambient temperature (T_a) is 40°C and that the failure criterion is a 30% decrease in light output.

Suppose that the initial LED current, I_F , is 20 mA. Since the horizontal axis of the failure criteria graph is the reciprocal of absolute temperature, it is necessary to convert the ambient temperature (T_a) to the reciprocal of absolute temperature (T):

$$T = \frac{I}{T_a + 273.15} = \frac{I}{40 + 273.15} \doteq 3.19 \times 10^{-3}$$

The graph shows the projected lifetimes for F50% and F0.1% cumulative failure probabilities in solid and dashed lines respectively. Normally, it is recommended to use F0.1% lines.

As $X = 3.19$, its intersection with the $I_F = 20$ mA line for F0.1% is approximately 80,000 hours. (This figure is for reference only.)

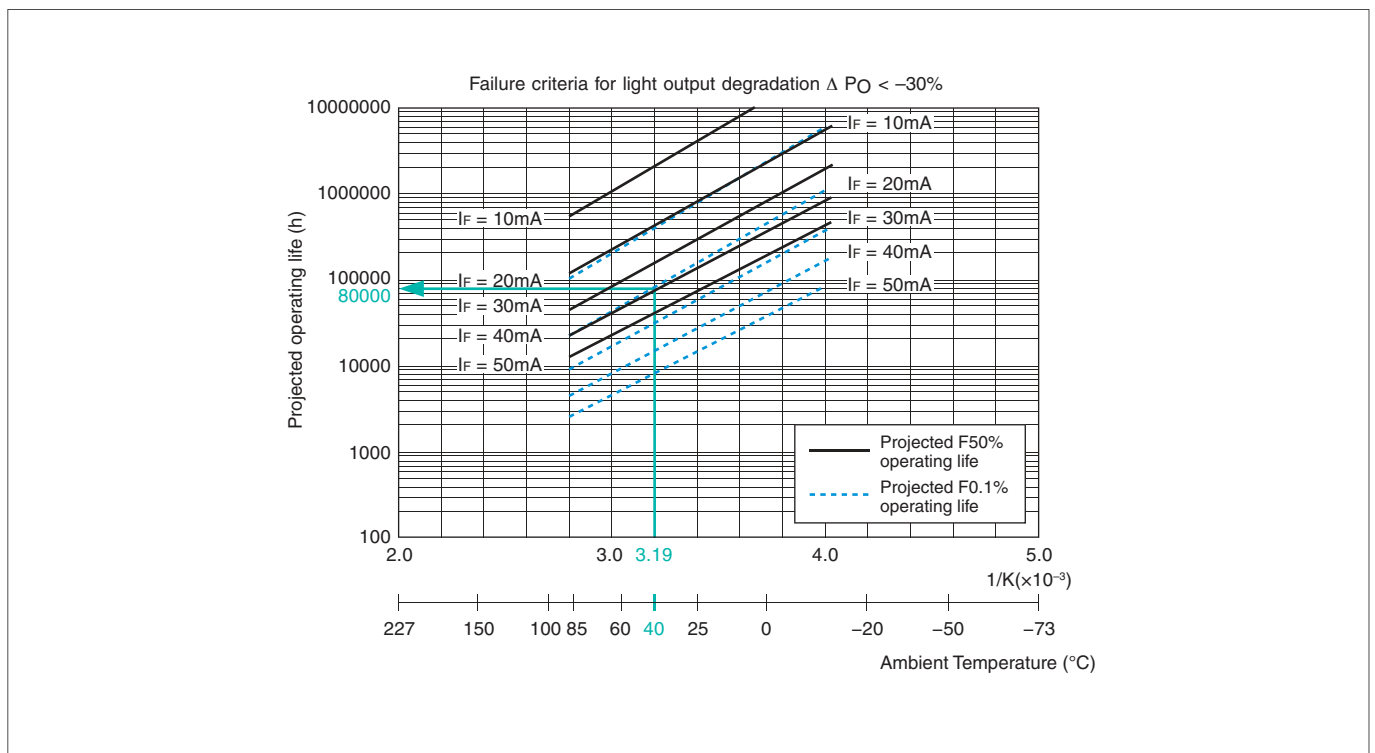

You can also estimate the projected operating life from the projected light output degradation data.

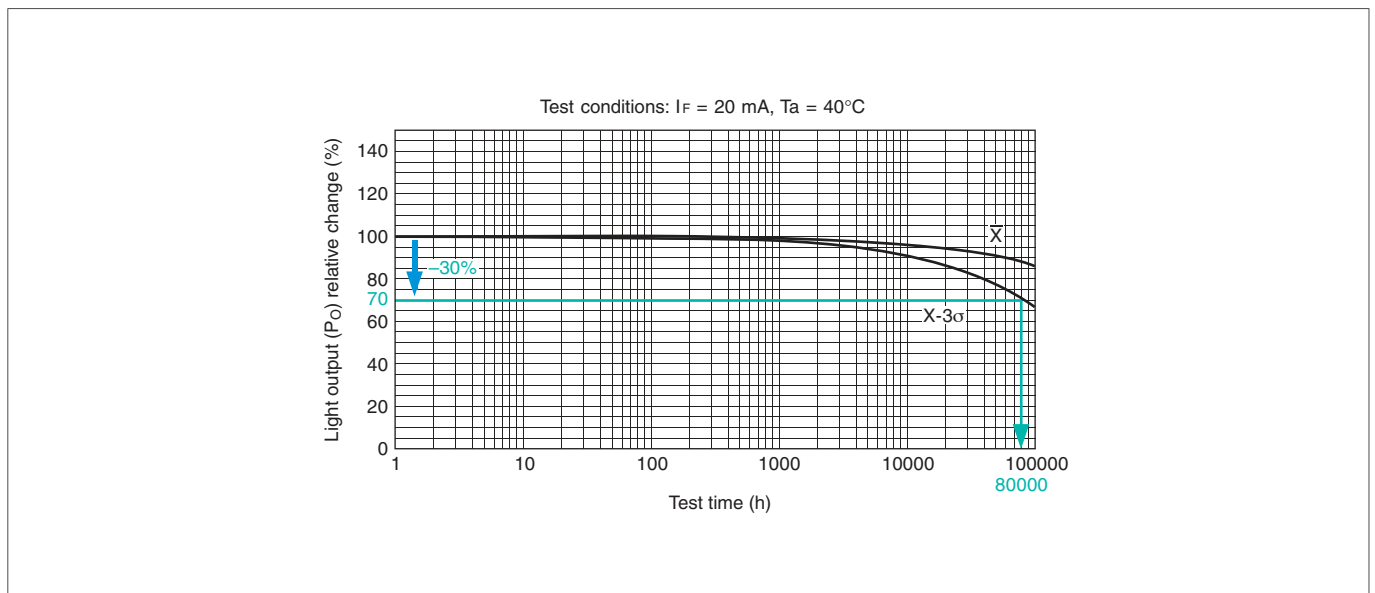

10 Safety Standard Approvals

Toshiba offers a wide selection of photocouplers with a transistor output, IC output, thyristor output and triac output, as well as photorelays certified to UL (USA), cUL (Canada), VDE (Germany), BSI (Britain) and SEMKO (Sweden).

Safety Standard Approvals for Photocouplers (DIN EN60747-5-2)

Mechanical Construction		Reflective Photocouplers in Single-Molded Packages			Transmissive Photocouplers in Single-Molded Packages				
Internal Construction									
Package		SOP4/SOP16		MFSOP6	MFSOP6	SO8 (2 ch)	2.54SOP 4/6/8	DIP	DIP (F type)
Construction Mechanical Ratings (min)	Isolation Creepage Path (mm)	4.0	5.0	4.0	4.0	4.2	4.0	6.4/7.0	8.0
	Isolation Clearance (mm)	4.0	5.0	4.0	4.0	4.2	4.0	6.4/7.0	8.0
	Isolation Thickness (mm)	0.4	0.4	0.4	–	–	–	(0.4)	(0.4)
	Internal Creepage Path (mm)	–	–	–	–	–	–	–	–
VDE/TÜV DIN EN 60747-5-2	Max. Working Insulation Voltage (Viorm)	565 Vpk	707 Vpk	565 Vpk	565 Vpk	565 Vpk	565 Vpk	630 Vpk /890 Vpk	1140 Vpk
	Highest Allowable Overvoltage (Viotm)	4000 Vpk	6000 Vpk	6000 Vpk	4000 Vpk	4000 Vpk	2500 Vpk	4000 Vpk	6000 Vpk
Certified Devices	IC Output					TLP2105 TLP2108 TLP2166A TLP2116 TLP2117		TLP350 TLP351	TLP350F TLP351F
	Transistor Output	TLP280 TLP280-4 TLP281 TLP281-4	TLP284 TLP284-4 TLP285 TLP285-4	TLP180 TLP181	TLP127				
	Triac/Thyristor Output			TLP260J TLP261J	TLP160G TLP160J TLP161G TLP161J			TLP560G TLP560J TLP561G TLP561J	
	Photorelay						TLP176A TLP176D TLP176G TLP197G TLP206G	TLP227G TLP227G-2 TLP597G	

The table above lists photocouplers and photorelays that have already been approved as of January 2011. The information herein is subject to change. For the latest information, please contact your nearest Toshiba sales representative.

10 Safety Standard Approvals

Safety Standard Approvals for Photocouplers (DIN EN60747-5-2) (Continued)

Mechanical Construction		Transmissive Photocouplers with an Insulating Film in Single-Molded Packages					Transmissive Photocouplers in Double-Molded Packages			
Internal Construction										
Package		SO8 (1 ch)	SDIP6	SDIP6 (F type)	DIP	DIP (F type)	MFSOP6	SO6	DIP	DIP (F type)
Construction Mechanical Ratings (min)	Isolation Creepage Path (mm)	4.2	7.0	8.0	6.4/7.0	8.0	4.0	5.0	6.5/7.0	8.0
	Isolation Clearance (mm)	4.2	7.0	8.0	6.4/7.0	8.0	4.0	5.0	6.5/7.0	8.0
	Isolation Thickness (mm)	0.4	0.4	0.4	0.4/0.5	0.4/0.5	–	0.4	0.4/0.5	0.4/0.5
	Internal Creepage Path (mm)	–	–	–	–	–	–	–	4.0	4.0
VDE/TÜV DIN EN 60747-5-2	Max. Working Insulation Voltage (Viorm)	565 Vpk	890 Vpk	1140 Vpk	890 Vpk	1140 Vpk	565 Vpk	707 Vpk	890 Vpk /1130 Vpk	890 Vpk /1130 Vpk
	Highest Allowable Overvoltage (Viotm)	6000 Vpk	8000 Vpk	8000 Vpk	6000 Vpk /8000 Vpk	6000 Vpk /8000 Vpk	4000 Vpk /6000 Vpk	6000 Vpk	6000 Vpk /8000 Vpk	6000 Vpk /8000 Vpk
Certified Devices	IC Output	TLP2403 TLP2405 TLP2408 TLP2409	TLP701 TLP705 TLP715 TLP716 TLP718 TLP719	TLP701F TLP705F TLP715F TLP716F TLP718F TLP719F	TLP350H TLP351H TLP750 TLP751 TLP759	TLP350HF TLP351HF TLP750F TLP751F TLP759F	TLP105 TLP108 TLP114A TLP116 TLP117 TLP2066	TLP109 TLP116A TLP104 TLP151		
	Transistor Output				TLP620 TLP620-2 TLP620-4 TLP627 TLP627-2 TLP627-4 TLP731 TLP732	TLP620F TLP620F-2 TLP621F TLP621F-2			TLP733 TLP734 TLP781	TLP733F TLP734F TLP781F
	Triac/Thyristor Output				TLP360J TLP361J TLP363J TLP3022(S) TLP3023(S) TLP3042(S) TLP3043(S) TLP3052(S) TLP3062(S) TLP3063(S) TLP3064(S) TLP3082(S) TLP3762(S) TLP3782(S) TLP3783(S)	TLP360JF TLP361JF TLP363JF TLP3022F(S) TLP3023F(S) TLP3042F(S) TLP3043F(S) TLP3052F(S) TLP3062F(S) TLP3063F(S) TLP3064F(S) TLP3082F(S) TLP3762F(S) TLP3782F(S) TLP3783F(S)	TLP165J TLP166J	TLP265J TLP266J	TLP762J TLP763J TLP748J	TLP762JF TLP763JF TLP748JF

The table above lists photocouplers and photorelays that have already been approved as of January 2011. The information herein is subject to change. For the latest information, please contact your nearest Toshiba sales representative.

11 Photocoupler Application Circuit Examples

1 Digital Interface Applications

High Speed

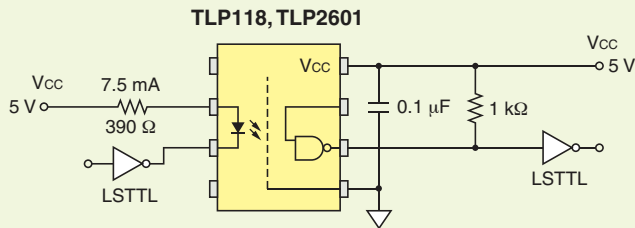

The **TLP2601** allows high-speed data transmission at up to approximately 5 MHz.

Data rate of left-side circuit

f (typ.): 5 Mbit/s (duty cycle $\approx 1/2$)

Low Input Current Drive

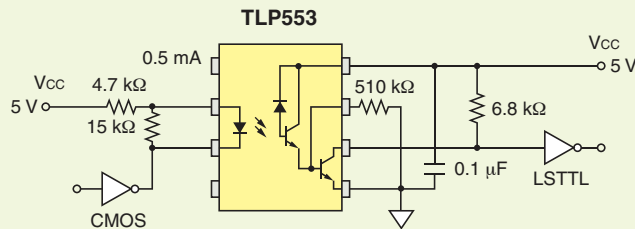

The high-CTR (current transfer ratio) **TLP553** allows operation with low input current (0.5 mA) and direct driving with a CMOS signal.

Data rate of left-side circuit

f (typ.): 50 kbit/s (duty cycle $\approx 1/2$)

No Pull-up Resistor Required

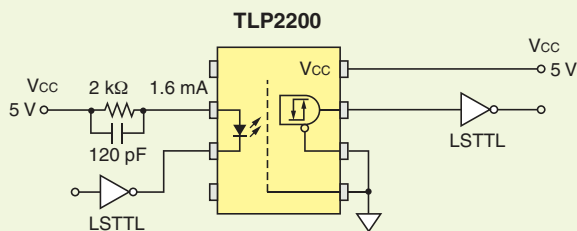

When the **TLP2200** with a 3-state output is used, the next-stage logic gate can be actuated without using a pull-up resistor.

Data rate of left-side circuit

f (typ.): 1 Mbit/s (duty cycle $\approx 1/2$)

High Vcc Tolerance

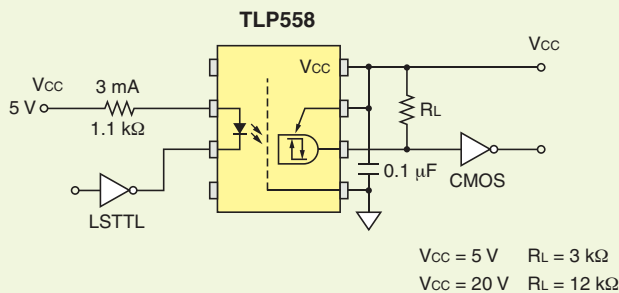

By using the **TLP558** which tolerates V_{cc} up to 20 V, CMOS logic gates and other components can be driven without design restrictions on V_{cc} .

Data rate of left-side circuit

f (typ.): 1 Mbit/s (duty cycle $\approx 1/2$)

11 Photocoupler Application Circuit Examples

2 Inverter and AC-DC Servo Applications

[Photo-IC couplers: high-speed base/gate drive applications]

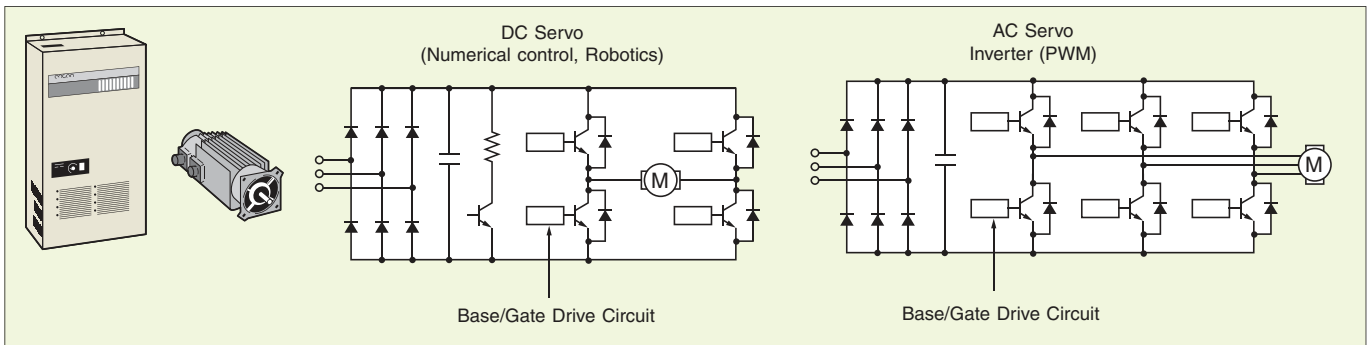
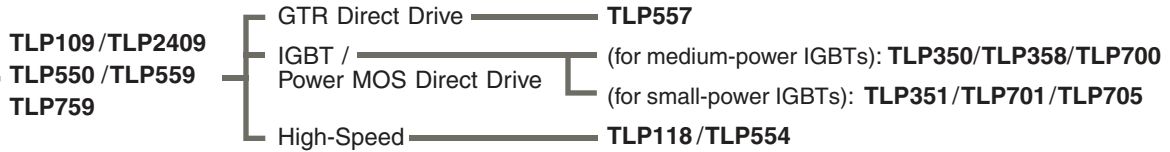

Driving the Base of a 15-A-Class GTR (Giant Transistor) Module

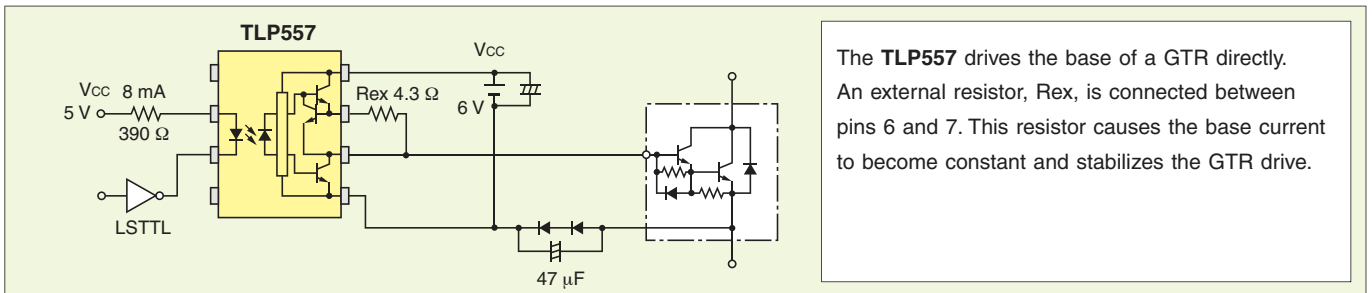

Driving the Base of a 100-A-Class GTR Module

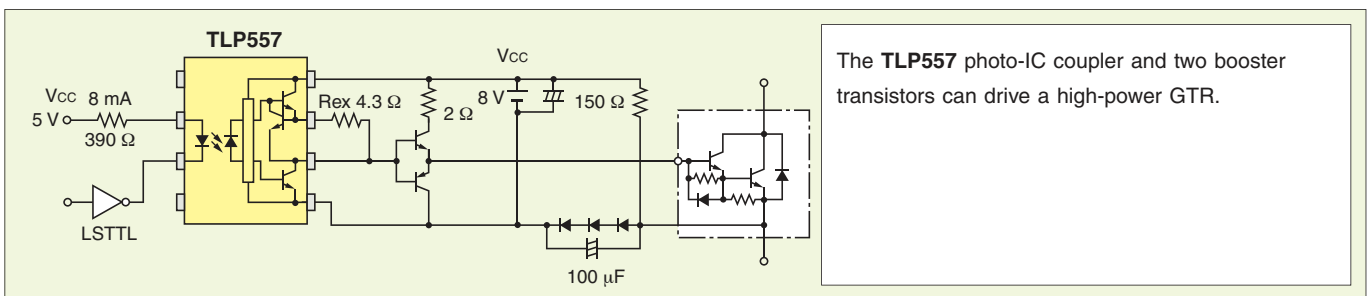

Driving the Gate of a 15-A-Class IGBT (Insulated Gate Bipolar Transistor) Module

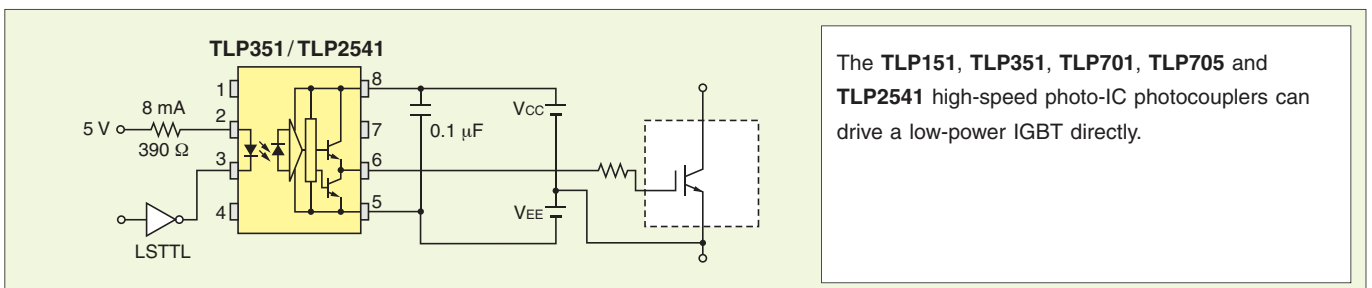

Driving the Gate of a 50-A-Class IGBT Module

The **TLP350** and **TLP700** can drive a medium-power IGBT directly.

Driving the Gate of a 400-A-Class IGBT Module

The **TLP351**, **TLP701**, **TLP705** or **TLP2541** high-speed photo-IC photocoupler and two booster transistors can drive a high power IGBT.

Driving the Gate of an IGBT Module Using an IGM Photocoupler

IGM photocouplers are suitable for driving an intelligent power module (IPM). These photocouplers guarantee symmetrical low-to-high and high-to-low propagation delays ($t_{PLH} - t_{PHL}$) and provides a high common mode transient immunity.

IGM Selection

Part Number	Package	BVs (Vrms)	Vo/Vcc	CTR	$ t_{PLH} - t_{PHL} $	CMH	CML
TLP109 (IGM)	SO6	3750	20 V / 30 V max	25% min 75% max @IF = 10 mA VCC = 4.5 V Vo = 0.4 V	0.7 μs max @IF = 10 mA RL = 20 kΩ	10000 V / μs min @IF = 0 mA RL = 20 kΩ VCM = 1500 Vp-p	- 10000 V / μs min @IF = 10 mA RL = 20 kΩ VCM = 1500 Vp-p
TLP559 (IGM)	DIP8	2500					
TLP759 (IGM)	DIP8	5000					

11 Photocoupler Application Circuit Examples

3 Home Appliance Applications

Electric Oven/Grills

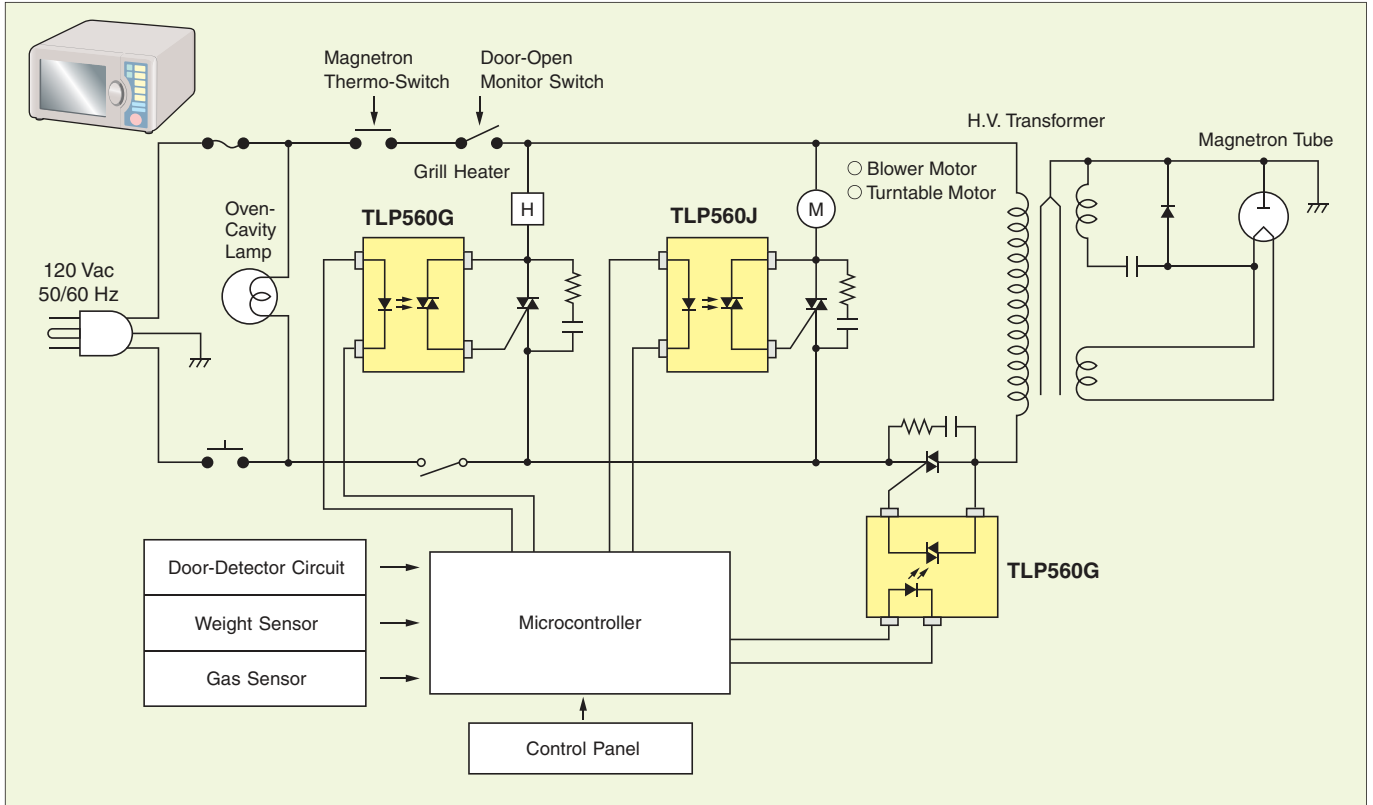

Refrigerator Block Diagram

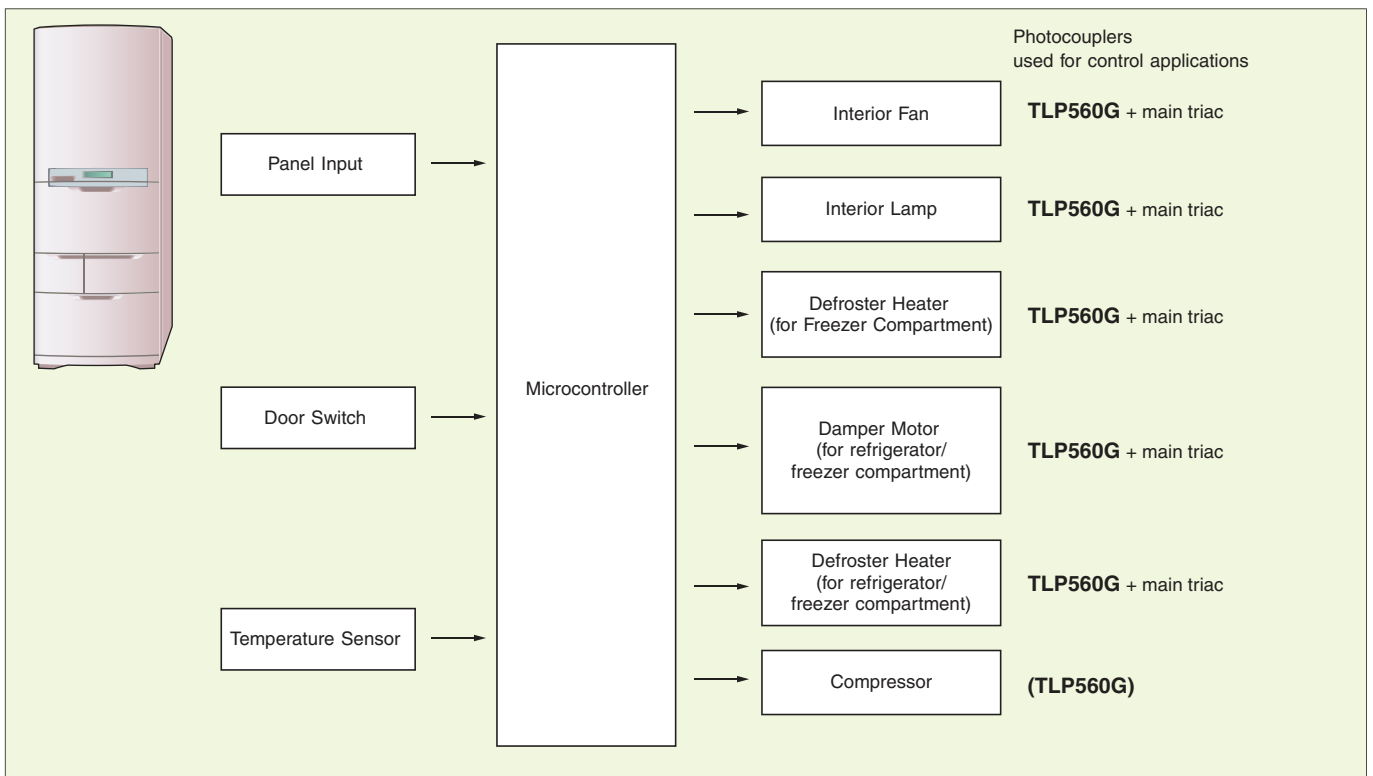

Automatic Washing Machines

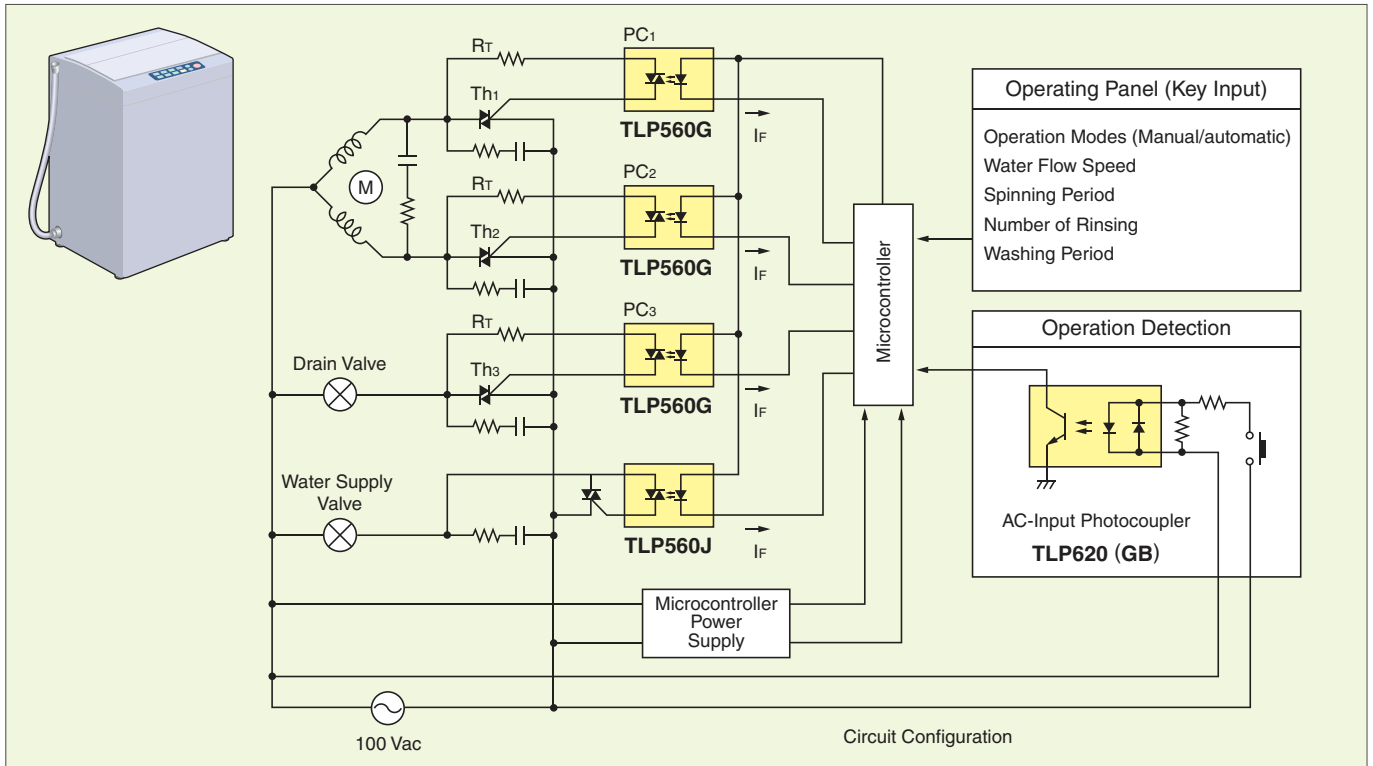

Fan Heaters

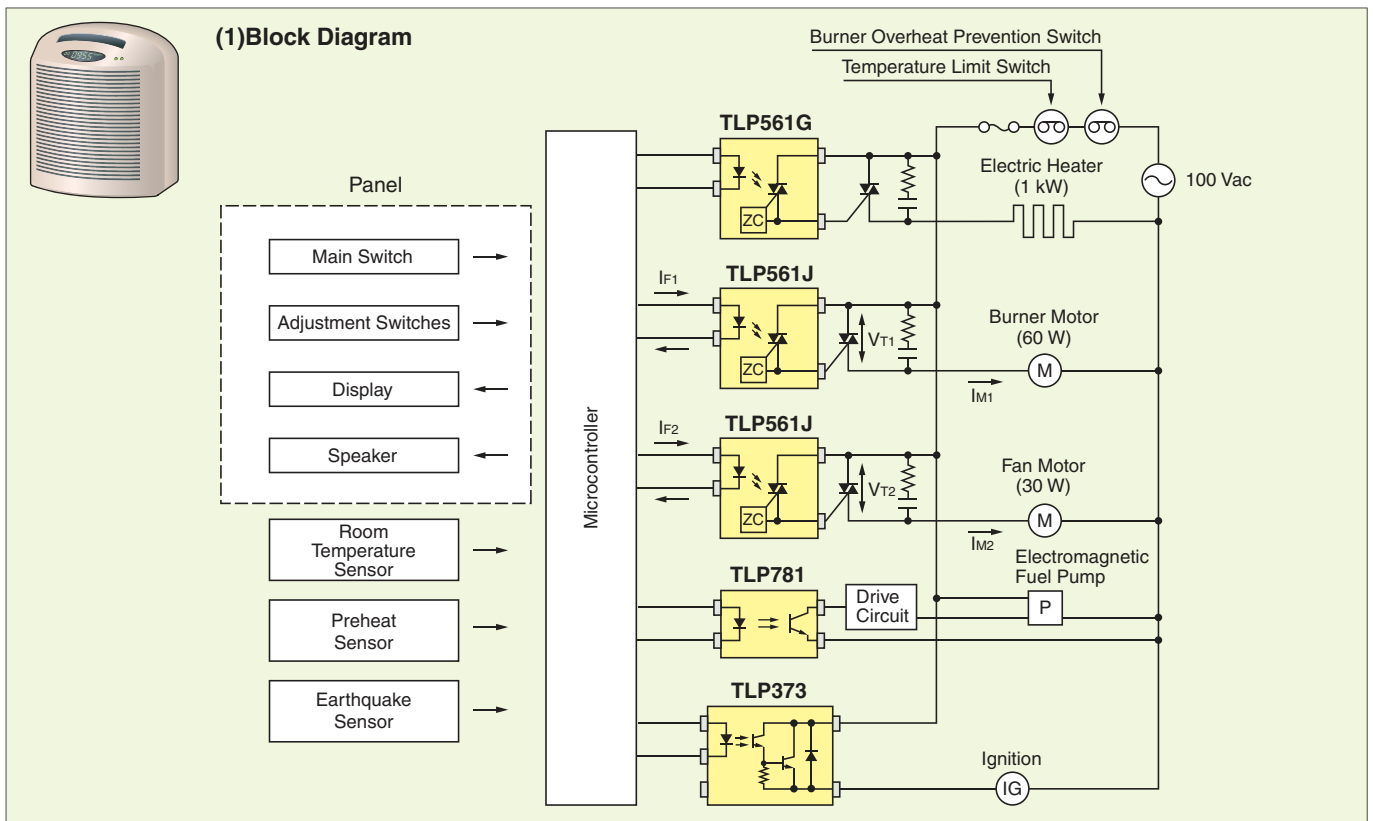

11 Photocoupler Application Circuit Examples

4 Home Appliance Applications (Continued)

(2) Waveform Examples

1. Example of Operating Waveform for Burner Motor

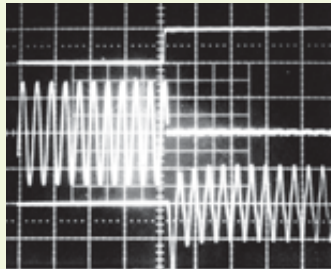

Trigger Point

waveforms {
 Top: I_{F1} 20 mA/div
 Medium: V_{T1} 100 V/div
 Bottom: I_{M1} 1 A/div
 Horizontal: time 50 ms/div

2. Example of Operating Waveform for Fan Motor

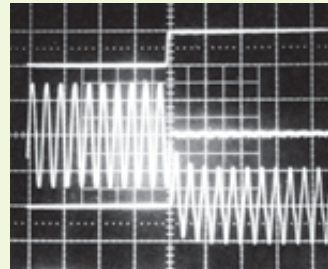

Trigger Point

waveforms {
 Top: I_{F2} 20 mA/div
 Medium: V_{T2} 100 V/div
 Bottom: I_{M2} 0.5 A/div
 Horizontal: time 50 ms/div

Inverter Air Conditioners

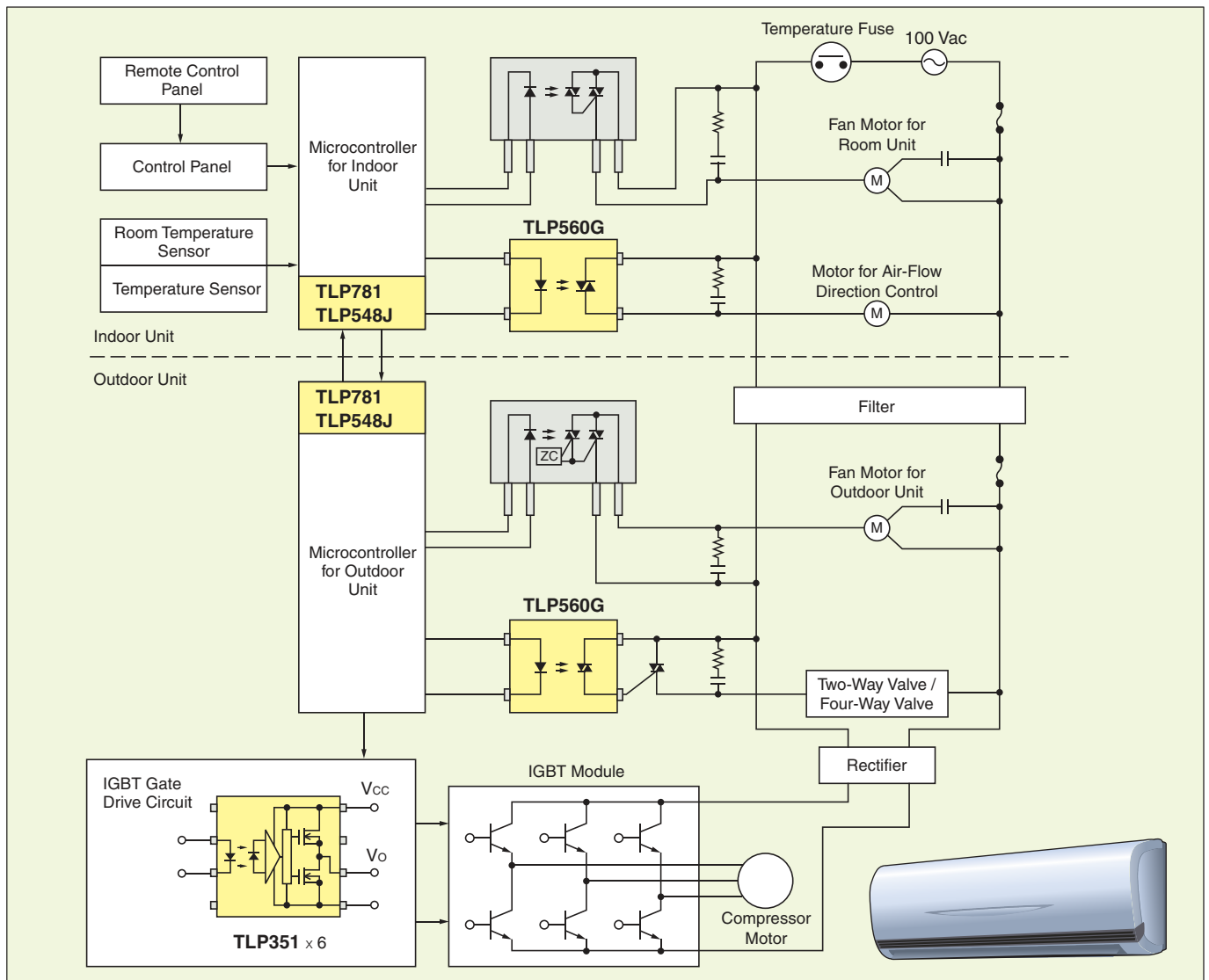

5 Programmable Controller Applications

DC Output for Sequencers

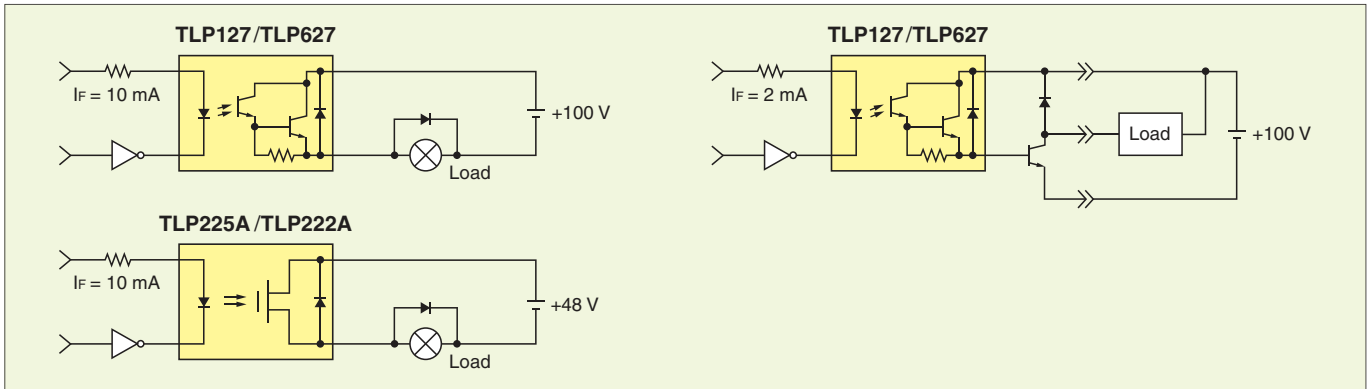

AC Input for Sequencers

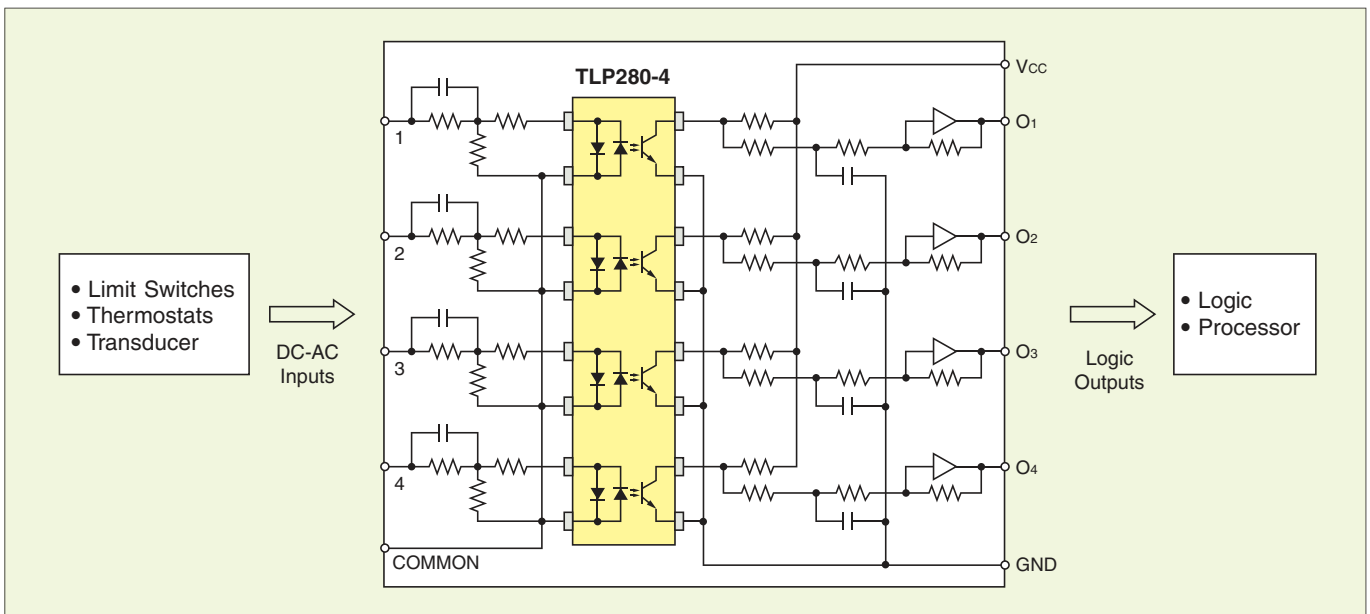

120-/240-Vac Output for Sequencers and Solid State Relays (SSRs)

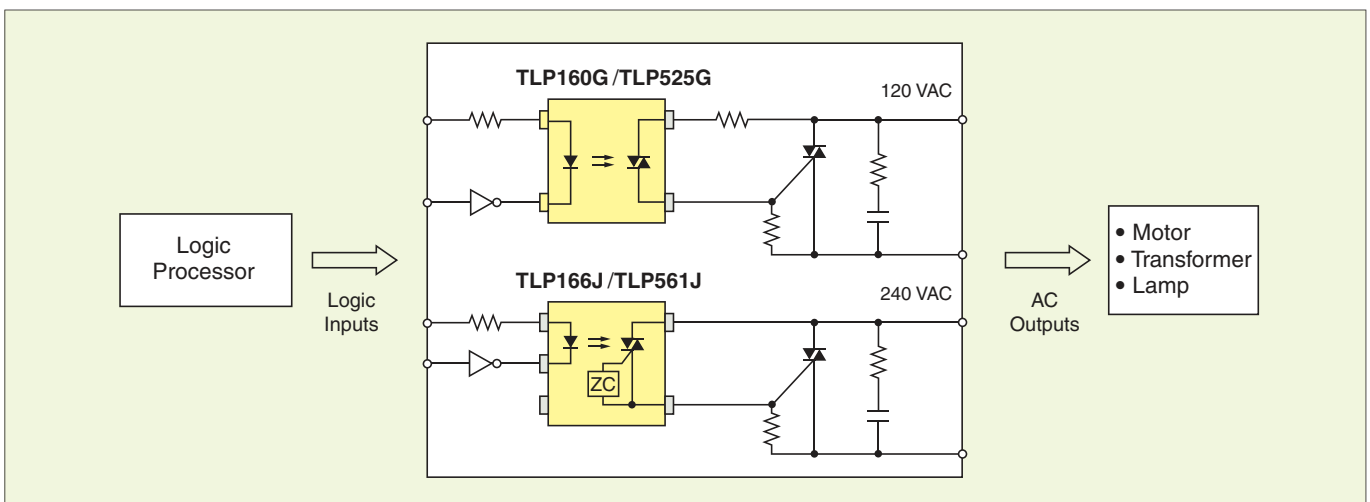

11 Photocoupler Application Circuit Examples

6 SSR and Power Control Circuit Applications

Zero-Crossing Phototriac Output: TLP161G/TLP561J and Mini-Flat TLP161G/TLP166J

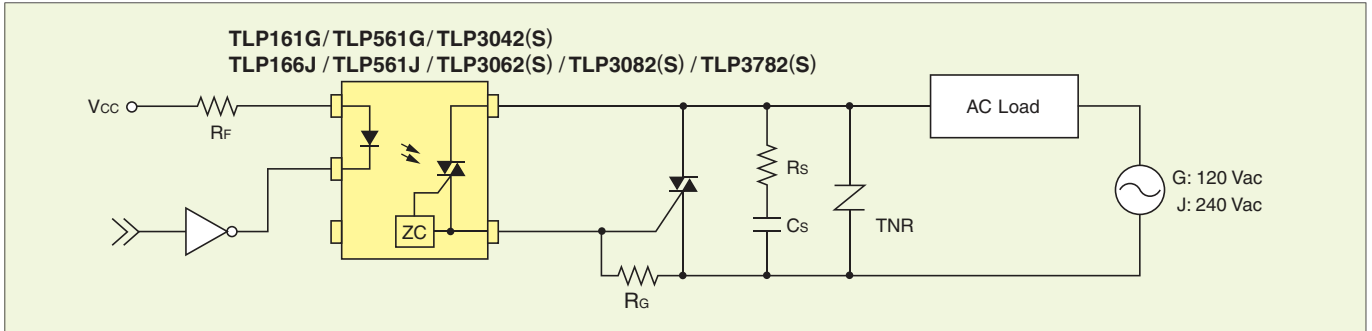

Lamp Load (1-A tungsten lamp)

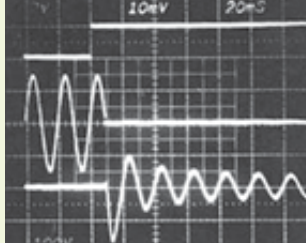

Waveforms { Top: I_F 20 mA/div
Medium: V_T 100 V/div
Bottom: I_T 5 A/div

L load (2.5-A pure inductive load)

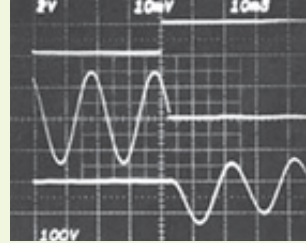

Recommended conditions { I_F = 20 mA
 R_G = 47 Ω
 R_S = 47 Ω , C_S = 0.033 μ F

Non-Zero Crossing Phototriac Output: TLP560G/TLP560J and Mini-Flat TLP160G/TLP260J

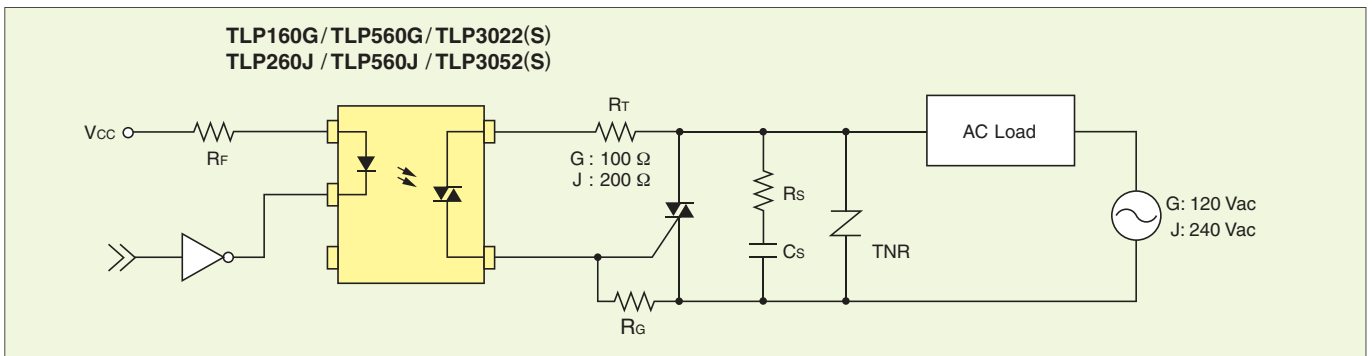

Lamp Load (1-A tungsten lamp)

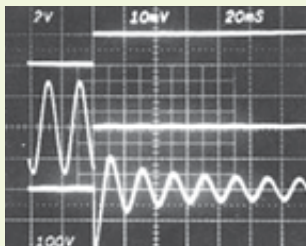

Waveforms { Top: I_F 20 mA/div
Medium: V_T 100 V/div
Bottom: I_T 5 A/div

L load (2.5-A pure inductive load)

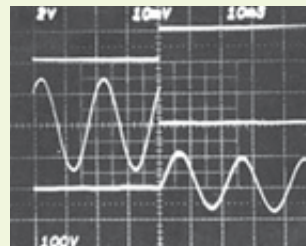

Recommended conditions { I_F = 20 mA
 R_T = 100 Ω /200 Ω
 R_G = 47 Ω
 R_S = 47 Ω , C_S = 0.033 μ F

7 Switching Power Supply Circuit Application

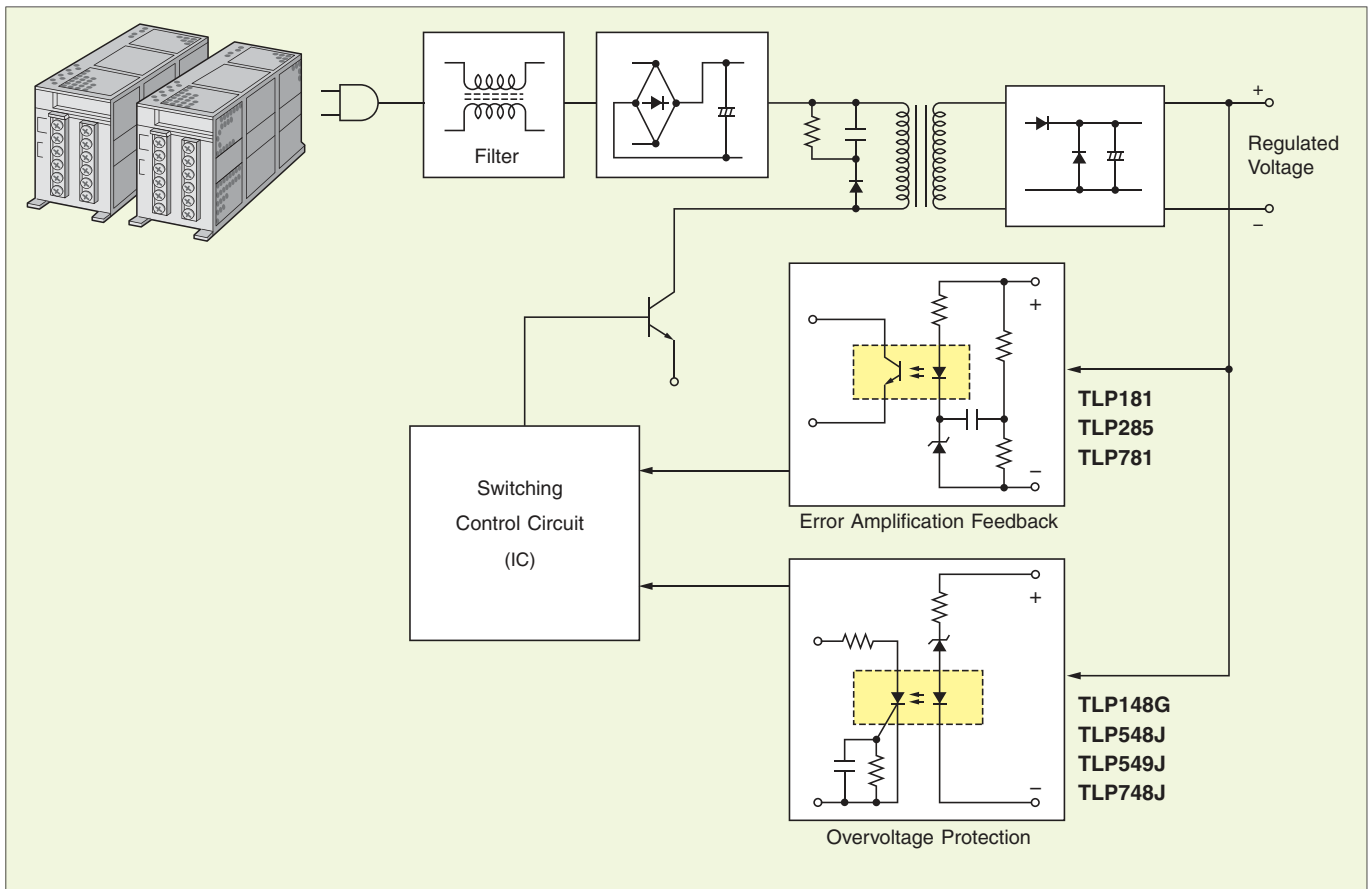

■ Transistor Output (○: Approved, as of January 2010)

Part Number	Package Type	Isolation Voltage	Safety Standard Approvals				CTR (Ic / If) Rank (%)		
			UL 1577	BSI 7002(EN60950)	EN60747 (Note 1)	Nordic SEMKO		Min	Max
TLP181/TLP285	MFSOP6/SOP4	3750 Vrms	○	○	○(Note 2)	○	No Rank (GB) Rank (Y) Rank (GR) Rank (BL) Rank (GRL) Rank (GRH) Rank (O) Rank No Rank	50	600
TLP781	DIP4	5000 Vrms	○*	○	○	○		100	600
								50	150
								100	300
								200	600
								100	200
TLP750 (high-speed)	DIP8	5000 Vrms	○	○	○	○	150	300	
							19	–	
							10	–	

■ Thyristor Output (○: Approved, as of January 2010)

Part Number	Package Type	Isolation Voltage	Safety Standard Approvals		IFT (mA)	VDRM (V)
			UL 1577	EN60747 (Note 1)		
TLP148G	MFSOP6	2500 Vrms	○		10	400
TLP548J	DIP6		○		7	600
TLP748J			4000 Vrms	○	○	10

Note 1: EN60747-approved with option (D4)

Note 2: The EN60747-5-2 safety standard for compact packages is different from those for standard DIP packages. Since the mini-flat package is a compact package, please contact your nearest Toshiba sales representative for more details.

*: Double protection

11 Photocoupler Application Circuit Examples

8 Push-Button Telephone Application

A variety of photocouplers are used to isolate between telephone lines (L1 and L2) and a CPU.

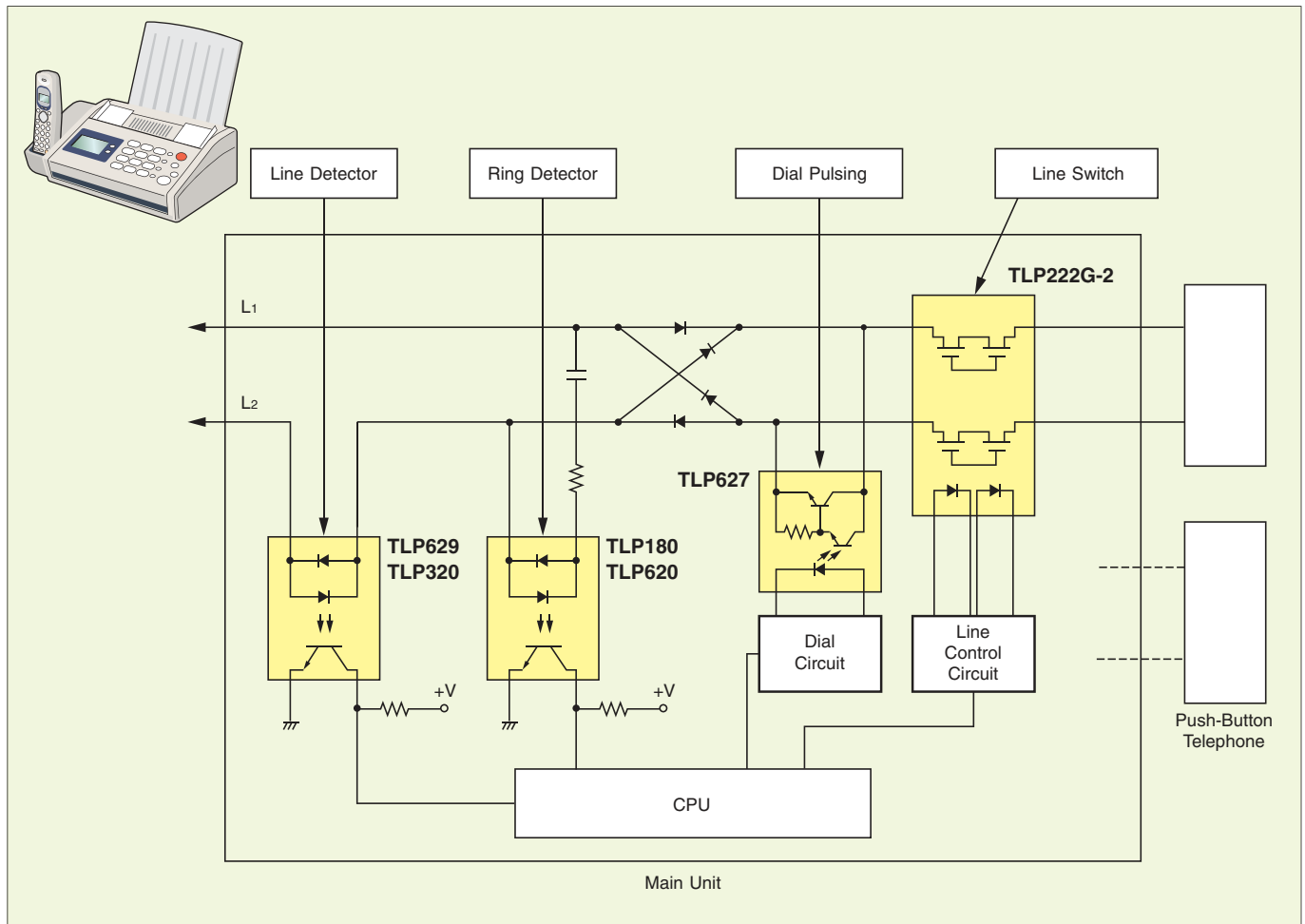

Application	Package Type	Part Number			Features	
		DC Input		AC Input		
Ring Detector	DIP4	TLP781			General single transistor output in compact packages Good cost performance	
	MFSOP6 SOP4	TLP181	TLP281	TLP285		TLP180 TLP280
Dial Pulsing	DIP4	TLP627			High-V _{CEO} (300 V) Darlington transistor output in compact packages Suitable to generate a pulse dial signal	
	MFSOP6	TLP127				
	DIP4	TLP628			High-V _{CEO} (350 V) single transistor output	
Line Detector	DIP4	TLP629		TLP320	High LED current rating = 150 mA Directly connectable to telephone lines	
Line Switch	DIP4	TLP222G*	TLP227G*		MOSFET-output photorelay with V _{OFF} = 400 V Crosspoint relay replacement (*: V _{OFF} = 350 V, **: V _{OFF} = 200 V)	
	DIP6	TLP592G*	TLP597G*			
	DIP8 (Dual)	TLP222G-2*	TLP227G-2*			
	2.54SOP4	TLP170G*	TLP176D**	TLP176G*		
	2.54SOP6	TLP192G*	TLP197G*			
	2.54SOP8 (Dual)	TLP200D**	TLP202G*	TLP206G*		

9 Photovoltaic Coupler Applications

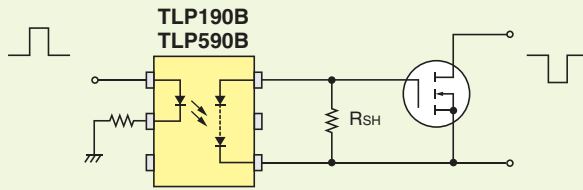

This is the simplest power MOSFET drive circuit. The resistor R_{SH} for discharging the gate capacitor reduces turn-off time. R_{SH} is not required for the TLP591B, which has a built-in resistor. (T_{ON} , $T_{OFF} \approx$ several ms)

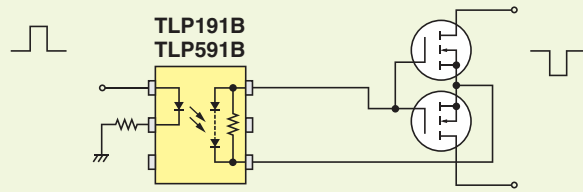

Both AC and DC drivers become possible by connecting power MOSFETs in a common-source configuration.

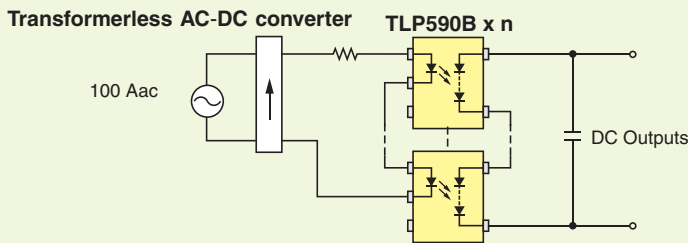

Photovoltaic couplers in a parallel-series configuration convert AC power to DC without a transformer. This type of configuration requires tens to hundreds of photovoltaic couplers.

10 Photorelays for Tester Application

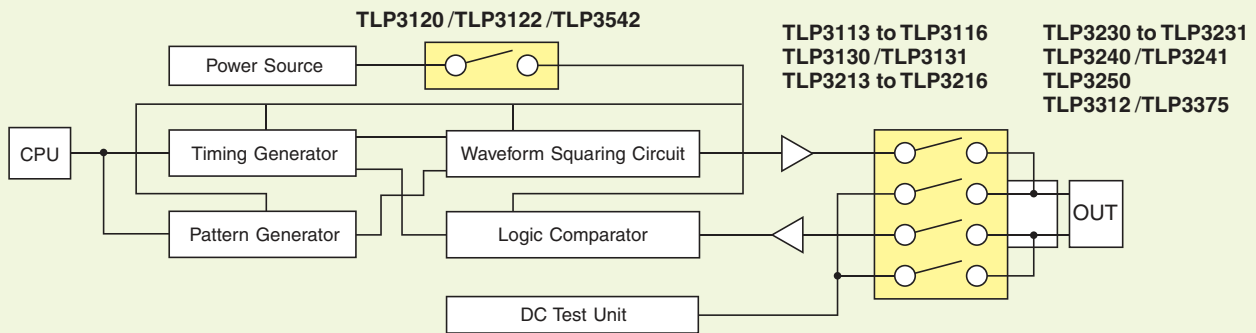

11 Photorelay (MOSFET Output) Application

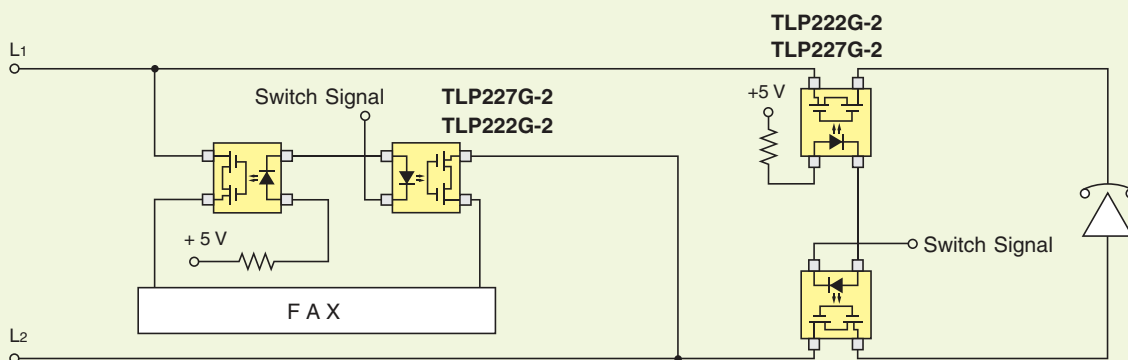

Example of Terminal Switching Application

11 Photocoupler Application Circuit Examples

12 NCU Circuit (Fax Modem Card) Application

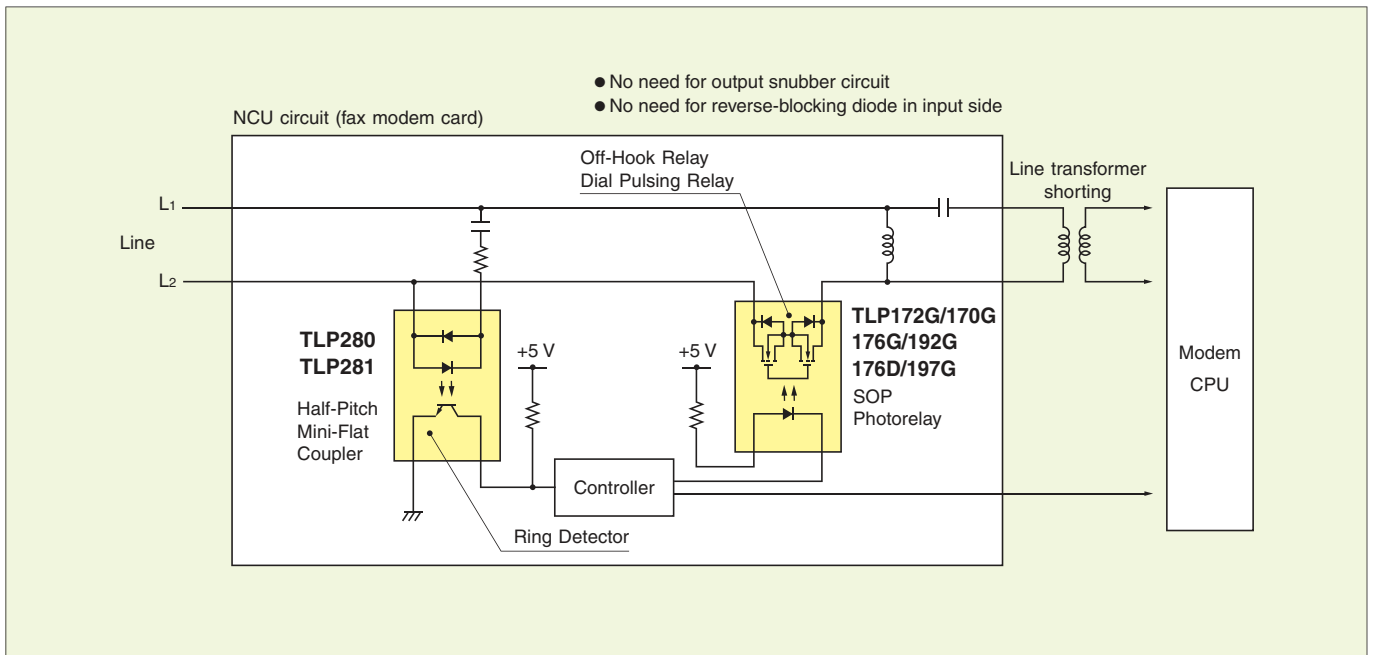

13 Competitor Part Number Cross Reference Search

The Toshiba Semiconductor webpage at <http://www.semicon.toshiba.co.jp/eng/product/opto/selection/coupler/xref/index.html> offers a cross reference search tool for photocouplers and photorelays.

TOSHIBA
Leading Innovation >>>

Product Number Search Search in this site

Contact Us Site Map

Print this page 日本語 繁体中文 简体中文

HOME > Products > Optical Semiconductor Devices > Product Introduction > Photocouplers/Photorelays > Cross Reference Search

Products

- Optical Semiconductor Devices
- Product Introduction
- Photocouplers/Photorelays
- Cross Reference Search

Applications Company Profile News and Event Support

Terms of Use Site Map

Photocouplers/Photorelays Cross Reference Search

By entering a competitor's Photocoupler or Photorelay part number, you can find an equivalent part from Toshiba.

Cross Reference Search

Manufacturer: All Manufacturers Part Number:

Search

* require 3 characters or more.

* Cross Reference Search is possible only in a part of the manufacturer part number.

- The information presented in this cross reference is based on TOSHIBA's selection criteria and should be treated as a suggestion only. Please carefully review the latest versions of all relevant information on the TOSHIBA products, including without limitation data sheets and validate all operating parameters of the TOSHIBA products to ensure that the suggested TOSHIBA products are truly compatible with your design and application.
- Please note that this cross reference is based on TOSHIBA's estimate of compatibility with other manufacturers' products, based on other manufacturers' published data, at the time the data was collected.
- TOSHIBA is not responsible for any incorrect or incomplete information. Information is subject to change at any time without notice.

Top of this page ▲

12 Competitor Cross Reference

NEC

Part Number	Toshiba Part Number
PS2501-1	TLP781
PS2561-1	TLP781
PS2571-1	TLP781
PS2581L1	TLP781F
PS2505-1	TLP620
PS2565-1	TLP620
PS2502-1	TLP627
PS2562-1	TLP627
PS2532-1	TLP627
PS2533-1	TLP627
PS2521-1	TLP629
PS2525-1	TLP320
PS2701-1	TLP181
PS2761-1	TLP181
PS2705-1	TLP180
PS2765-1	TLP180
PS2702-1	TLP127
PS2801-1	TLP281
PS2801-4	TLP281-4
PS2861-1	TLP281
PS2805-1	TLP280
PS2805-4	TLP280-4
PS2865-1	TLP280
PS8601	TLP759
PS8602	TLP759
PS9613	TLP759 (IGM)
PS8701	TLP109
PS8101	TLP109
PS9713	TLP109 (IGM)
PS9113	TLP109 (IGM)
PS9601	TLP554
PS9614	TLP554
PS9714	TLP118
PS9114	TLP118
PS9715	TLP118
PS9115	TLP118
PS9701	TLP118
PS7141-1A	TLP597GA
PS7141-2A	TLP227GA-2
PS7141-1B	TLP4597G
PS7141-2B	TLP4227G-2
PS7141-1C	TLP4006G
PS7341C-1A	TLP594G
PS7141C-2A	TLP224G-2
PS7241-1A	TLP176GA
PS7241-2A	TLP206GA
PS7241-1B	TLP4176G
PS7241-2B	TLP4206G
PS7241-1C	TLP4026G

Panasonic

Part Number	Toshiba Part Number
AQV210	TLP592G
AQV210E	TLP597G
AQV210EH	TLP797GA
AQV210S	TLP192G
AQV212	TLP592A
AQV212S	TLP197A
AQV214	TLP597GA
AQV214E	TLP597G
AQV214EH	TLP797GA
AQV214H	TLP797GA
AQV214S	TLP197GA
AQV215	TLP597A
AQV216	TLP797J
AQV217S	TLP197D
AQV410EH	TLP4592G
AQV414	TLP4592G
AQV414E	TLP4597G
AQV414S	TLP4197G
AQW210	TLP222G-2
AQW210S	TLP202G
AQW212	TLP222A-2
AQW214	TLP227GA-2
AQW214S	TLP206GA
AQW215	TLP222A-2
AQW217	TLP222G-2
AQW414	TLP4222G-2
AQW610S	TLP4026G
AQW614	TLP4007G
AQY210EH	TLP227G
AQY210LS	TLP174G
AQY210S	TLP174G
AQY214EH	TLP227G
AQY214S	TLP176GA
AQY410EH	TLP4227G
AQY414EH	TLP4227G
AQY414S	TLP4176G
AQY221N1S	TLP3113/TLP3116
AQY221N2S	TLP3113/TLP3116
AQY221R2V	TLP3215
AQY221N2V	TLP3216

Vishay

Part Number	Toshiba Part Number
SFH614A	TLP628
SFH615A	TLP781
SFH617A	TLP781
SFH618A	TLP624
TCET1100	TLP781
SFH690xT	TLP181
TCMT1100	TLP281
TCMT4100	TLP281-4
SFH628A	TLP620
K815P	TLP627
SFH612A	TLP627
SFH619A	TLP627
SFH655A	TLP627
SFH692AT	TLP127
TCED1100	TLP627
IL66	TLP371
IL66B	TLP372
IL255	TLP330

SHARP

Part Number	Toshiba Part Number
PC123	TLP781
PC817	TLP781
PC813	TLP620
PC815	TLP627
PC357NT	TLP181
PC354NT	TLP180
PC355NT	TLP127
PC3H7	TLP281
PC3H3	TLP280
PC3H21	TLP525G
PC410	TLP118
PC942	TLP351
PC923	TLP351
S2S3	TLP260J
S2S4	TLP161J
PR36MF11NSZ	TLP3506
PR36MF12NSZ	TLP3506
S21MD3V	TLP3051 (S)
S201D01	TLP3526
S201D02	TLP3527

Fairchild

Part Number	Toshiba Part Number
FOD617	TLP781
FOD814	TLP620
FOD815	TLP627
FOD817	TLP781
FOD852	TLP627
FODM3021	TLP160G
FODM3022	TLP160G
FODM3051	TLP160J
FODM3052	TLP160J
H11A617	TLP781
H11A817	TLP781
H11AA814	TLP620
H11B815	TLP627
HMA121	TLP181
HMA124	TLP124
HMA2701	TLP181
HMHA2801	TLP281
HMHA281	TLP281
HMAA2705	TLP180
HMHAA280	TLP280
H11A1	TLP631
H11AA1	TLP630
H11AG1	TLP331
H11B1	TLP571
H11C1	TLP541G
H11D1	TLP371
H11G1	TLP371
MOC3021-M	TLP3021 (S)
MOC3022-M	TLP3022 (S)
MOC3023-M	TLP3023 (S)
MOC3041-M	TLP3041 (S)
MOC3042-M	TLP3042 (S)
MOC3043-M	TLP3043 (S)
MOC3051-M	TLP3051 (S)
MOC3052-M	TLP3052 (S)
MOC3061-M	TLP3061 (S)
MOC3062-M	TLP3062 (S)
MOC3063-M	TLP3063 (S)

Avago

Part Number	Toshiba Part Number
HCPL-M600	TLP118
HCPL-M601	TLP118
HCPL-M611	TLP118
HCPL-M452	TLP109
HCPL-M453	TLP109
HCPL-M456	TLP109
HCPL-2601	TLP2601
HCPL-2611	TLP2601
HCPL-2201	TLP555
HCPL-2530	TLP2530
HCPL-2531	TLP2531
HCPL-2630	TLP2631
HCPL-2631	TLP2631
HCPL-3120	TLP350
HCPL-3140	TLP351
HCPL-3150	TLP351
HCPL-3180	TLP350
HCPL-314J	TLP701 x2
HCPL-4504	TLP559
HCPL-0708	TLP116A
HCPL-181	TLP181
HCPL-354	TLP180
HCPL-814	TLP620

LITEON

Part Number	Toshiba Part Number
LTV-123	TLP781
LTV-816	TLP781
LTV-817	TLP781
LTV-851	TLP628
LTV-356T	TLP181
LTV-357T	TLP181
LTV-814	TLP620
LTV-814H	TLP320
LTV-354T	TLP180
LTV-815	TLP627
LTV-852	TLP627
LTV-352T	TLP127
LTV-355T	TLP127
MOC3020	TLP3020 (S)
MOC3021	TLP3021 (S)
MOC3022	TLP3022 (S)
MOC3023	TLP3023 (S)
MOC3051	TLP3051 (S)
MOC3052	TLP3052 (S)
MOC3061	TLP3061 (S)
MOC3062	TLP3062 (S)
MOC3063	TLP3063 (S)

COSMO

Part Number	Toshiba Part Number
K1010	TLP781
K2010	TLP631
K3010	TLP620
KP3020	TLP620-2
KP4010	TLP627
KP4020	TLP627-2
K5010	TLP371
K6010	TLP630
KPS2801	TLP281
KPC354NT	TLP180
KPC355NT	TLP127
KPC357NT	TLP181
KPC452	TLP127

Note: For details of equivalent devices such as electrical performance and package dimensions, please refer to the latest datasheets.

Toshiba America**Electronic Components, Inc.**

- Irvine, Headquarters
Tel: (949)623-2900 Fax: (949)474-1330
- Buffalo Grove (Chicago)
Tel: (847)484-2400 Fax: (847)541-7287
- Duluth/Atlanta
Tel: (770)931-3363 Fax: (770)931-7602
- El Paso
Tel: (915)771-8156
- Marlborough
Tel: (508)481-0034 Fax: (508)481-8828
- Parsippany
Tel: (973)541-4715 Fax: (973)541-4716
- San Jose
Tel: (408)526-2400 Fax: (408)526-2410
- Wixom (Detroit)
Tel: (248)347-2607 Fax: (248)347-2602
- Bloomington
Tel: (952)842-2400 Fax: (952)893-8031
- San Diego
Tel: (858)385-5900 Fax: (858)674-7606

Toshiba Electronics do Brasil Ltda.

Tel: (011)2539-6681 Fax: (011)2539-6675

Toshiba Electronics Europe GmbH

- Düsseldorf Head Office
Tel: (0211)5296-0 Fax: (0211)5296-400
- France Branch
Tel: (1)47282181
- Italy Branch
Tel: (039)68701 Fax: (039)6870205
- Spain Branch
Tel: (91)660-6798 Fax: (91)660-6799
- U.K. Branch
Tel: (0870)060-2370 Fax: (01252)53-0250
- Sweden Branch
Tel: (08)704-0900 Fax: (08)80-8459

Toshiba Electronics Asia (Singapore) Pte. Ltd.

Tel: (6278)5252 Fax: (6271)5155

Toshiba Electronics Service (Thailand) Co., Ltd.

Tel: (02)501-1635 Fax: (02)501-1638

Toshiba Electronics Trading (Malaysia) Sdn. Bhd.

- Kuala Lumpur Head Office
Tel: (03)5631-6311 Fax: (03)5631-6307
- Penang Office
Tel: (04)226-8523 Fax: (04)226-8515

Toshiba India Private Ltd.

Tel: (0124)499-6600 Fax: (0124)499-6611

Toshiba Electronics Asia, Ltd.

- Hong Kong Head Office
Tel: 2375-6111 Fax: 2375-0969
- Beijing Office
Tel: (010)6590-8796 Fax: (010)6590-8791
- Chengdu Office
Tel: (028)8675-1773 Fax: (028)8675-1065
- Qingdao Office
Tel: (532)8579-3328 Fax: (532)8579-3329

Toshiba Electronics (Shenzhen) Co., Ltd

Tel: (0755)2399-6897 Fax: (0755)2399-5573

Toshiba Electronics (Shanghai) Co., Ltd.

- Shanghai PUXI Branch
Tel: (021)6139-3888 Fax: (021)6190-8288
- Hangzhou Office
Tel: (0571)8717-5004 Fax: (0571)8717-5013
- Nanjing Office
Tel: (025)8689-0070 Fax: (025)8689-0070

Toshiba Electronics (Dalian) Co., Ltd.

Tel: (0411)8368-6882 Fax: (0411)8369-8282

Tsurong Xiamen Xiangyu Trading Co., Ltd.

Tel: (0592)226-1398 Fax: (0592)226-1399

Toshiba Electronics Korea Corporation

- Seoul Head Office
Tel: (02)3484-4334 Fax: (02)3484-4302
- Daegu Office
Tel: (053)428-7610 Fax: (053)428-7617

Toshiba Electronics Taiwan Corporation

- Taipei Head Office
Tel: (02)2508-9988 Fax: (02)2508-9999

- ▶ Toshiba Corporation, and its subsidiaries and affiliates (collectively "TOSHIBA"), reserve the right to make changes to the information in this document, and related hardware, software and systems (collectively "Product") without notice.
- ▶ This document and any information herein may not be reproduced without prior written permission from TOSHIBA. Even with TOSHIBA's written permission, reproduction is permissible only if reproduction is without alteration/omission.
- ▶ Though TOSHIBA works continually to improve Product's quality and reliability, Product can malfunction or fail. Customers are responsible for complying with safety standards and for providing adequate designs and safeguards for their hardware, software and systems which minimize risk and avoid situations in which a malfunction or failure of Product could cause loss of human life, bodily injury or damage to property, including data loss or corruption. Before customers use the Product, create designs including the Product, or incorporate the Product into their own applications, customers must also refer to and comply with (a) the latest versions of all relevant TOSHIBA information, including without limitation, this document, the specifications, the data sheets and application notes for Product and the precautions and conditions set forth in the "TOSHIBA Semiconductor Reliability Handbook" and (b) the instructions for the application with which the Product will be used with or for. Customers are solely responsible for all aspects of their own product design or applications, including but not limited to (a) determining the appropriateness of the use of this Product in such design or applications; (b) evaluating and determining the applicability of any information contained in this document, or in charts, diagrams, programs, algorithms, sample application circuits, or any other referenced documents; and (c) validating all operating parameters for such designs and applications. **TOSHIBA ASSUMES NO LIABILITY FOR CUSTOMERS' PRODUCT DESIGN OR APPLICATIONS.**
- ▶ Product is intended for use in general electronics applications (e.g., computers, personal equipment, office equipment, measuring equipment, industrial robots and home electronics appliances) or for specific applications as expressly stated in this document. Product is neither intended nor warranted for use in equipment or systems that require extraordinarily high levels of quality and/or reliability and/or a malfunction or failure of which may cause loss of human life, bodily injury, serious property damage or serious public impact ("Unintended Use"). Unintended Use includes, without limitation, equipment used in nuclear facilities, equipment used in the aerospace industry, medical equipment, equipment used for automobiles, trains, ships and other transportation, traffic signaling equipment, equipment used to control combustions or explosions, safety devices, elevators and escalators, devices related to electric power, and equipment used in finance-related fields. Do not use Product for Unintended Use unless specifically permitted in this document.
- ▶ Do not disassemble, analyze, reverse-engineer, alter, modify, translate or copy Product, whether in whole or in part.
- ▶ Product shall not be used for or incorporated into any products or systems whose manufacture, use, or sale is prohibited under any applicable laws or regulations.
- ▶ The information contained herein is presented only as guidance for Product use. No responsibility is assumed by TOSHIBA for any infringement of patents or any other intellectual property rights of third parties that may result from the use of Product. No license to any intellectual property right is granted by this document, whether express or implied, by estoppel or otherwise.
- ▶ **ABSENT A WRITTEN SIGNED AGREEMENT, EXCEPT AS PROVIDED IN THE RELEVANT TERMS AND CONDITIONS OF SALE FOR PRODUCT, AND TO THE MAXIMUM EXTENT ALLOWABLE BY LAW, TOSHIBA (1) ASSUMES NO LIABILITY WHATSOEVER, INCLUDING WITHOUT LIMITATION, INDIRECT, CONSEQUENTIAL, SPECIAL, OR INCIDENTAL DAMAGES OR LOSS, INCLUDING WITHOUT LIMITATION, LOSS OF PROFITS, LOSS OF OPPORTUNITIES, BUSINESS INTERRUPTION AND LOSS OF DATA, AND (2) DISCLAIMS ANY AND ALL EXPRESS OR IMPLIED WARRANTIES AND CONDITIONS RELATED TO SALE, USE OF PRODUCT, OR INFORMATION, INCLUDING WARRANTIES OR CONDITIONS OF MERCHANTABILITY, FITNESS FOR A PARTICULAR PURPOSE, ACCURACY OF INFORMATION, OR NONINFRINGEMENT.**
- ▶ Product may include products using GaAs (Gallium Arsenide). GaAs is harmful to humans if consumed or absorbed, whether in the form of dust or vapor. Handle with care and do not break, cut, crush, grind, dissolve chemically or otherwise expose GaAs in Product.
- ▶ Do not use or otherwise make available Product or related software or technology for any military purposes, including without limitation, for the design, development, use, stockpiling or manufacturing of nuclear, chemical, or biological weapons or missile technology products (mass destruction weapons). Product and related software and technology may be controlled under the Japanese Foreign Exchange and Foreign Trade Law and the U.S. Export Administration Regulations. Export and re-export of Product or related software or technology are strictly prohibited except in compliance with all applicable export laws and regulations.
- ▶ Product may include products subject to foreign exchange and foreign trade control laws.
- ▶ Please contact your TOSHIBA sales representative for details as to environmental matters such as the RoHS compatibility of Product. Please use Product in compliance with all applicable laws and regulations that regulate the inclusion or use of controlled substances, including without limitation, the EU RoHS Directive. TOSHIBA assumes no liability for damages or losses occurring as a result of noncompliance with applicable laws and regulations.

© 2011 TOSHIBA CORPORATION

Previous edition: BCE0034F
2011-3(5k)SO-DQ**TOSHIBA****TOSHIBA CORPORATION**
Semiconductor CompanyWebsite: <http://www.semicon.toshiba.co.jp/eng>