

ABSTRACT

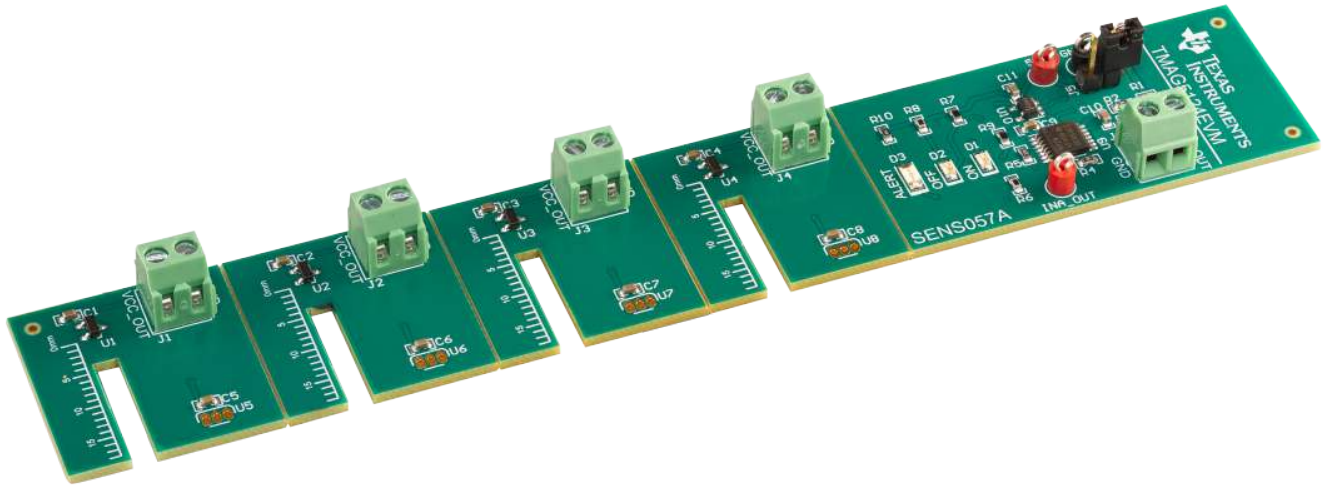

This user's guide describes the characteristics, operation, and use of the TMAG5124 2-wire evaluation module (EVM). This EVM is designed to evaluate the performance of the TMAG5124 over a separation of distance using current as the signal of interest. This document includes a schematic, printed-circuit board (PCB) layouts, and a complete bill of materials (BOM).

Table of Contents

1 Trademarks	2
2 Overview	3
2.1 TMAG5124EVM Kit Contents.....	3
2.2 Related Documentation From Texas Instruments.....	3
3 Hardware	4
3.1 Features.....	4
4 Quick Start	4
4.1 Option 1: Single 5-V Supply.....	4
4.2 Option 2: Separate VCC and 5-V Supply.....	4
4.3 Measurements.....	5
4.4 Standalone Measurements.....	5
5 Circuitry	7
5.1 TMAG5124 Coupon Boards.....	7
5.2 Logic, Feedback, and Display.....	7
5.3 J5.....	7
6 Schematic, PCB Layout, and Bill of Materials	8
6.1 Schematic.....	8
6.2 PCB Layout.....	9
6.3 Bill of Materials.....	10
7 Revision History	12

1 Trademarks

All trademarks are the property of their respective owners.

2 Overview

The TMAG5124 is a family of 2-wire Hall Effect sensors designed for system challenges where current is needed as an operating signal in place of voltage. This is most commonly found in applications where the Hall sensor is located some distance from the microcontroller or processor that acts on the signal, and signal integrity is of concern.

When the applied magnetic flux density exceeds the magnetic operating point (B_{OP}) threshold, the device output drives into a high or low current state, based on the device in use. When the magnetic flux density returns to a value below the magnetic release point (B_{RP}), the device output returns itself into a high or low current state, based on the device in use. [Table 2-1](#) lists device options.

Table 2-1. TMAG5124 Device Summary

Device	B_{OP} Sensitivity (typ.)	Current (typ.), Low state
TMAG5124A1	4mT	4 mA
TMAG5124B1	6mT	4 mA
TMAG5124C1	10mT	4 mA
TMAG5124D1	15mT	4 mA
TMAG5124E1	4mT	6 mA
TMAG5124F1	6mT	6 mA
TMAG5124G1	10mT	6 mA
TMAG5124H1	15mT	6 mA

This evaluation module is populated with four Z-axis oriented, north pole sensitive, active low devices. Each device exhibits a different sensitivity, allowing each of the sensitivities to be tested for use in an application. These devices produce an active low signal of 5 mA – 6.9 mA when the B_{OP} threshold is crossed, and a high signal of 12 mA – 15 mA when no magnet is present.

The device operates from a VCC range of 2.5V to 38V, and is available in a standard SOT-23 package.

2.1 TMAG5124EVM Kit Contents

[Table 2-2](#) lists the contents of the TMAG5124EVM kit. Contact the nearest [Texas Instruments Product Information Center](#) if any component is missing. TI highly recommends checking the TMAG5124 family product folder on the TI website at www.ti.com for further information regarding this product.

Table 2-2. TMAG5124 Kit Contents

Item	Quantity
TMAG5124EVM test board	1
Handheld magnet (D2X8)	1

2.2 Related Documentation From Texas Instruments

The following document provides information regarding TI's integrated circuits used in the assembly of the TMAG5124EVM. This user's guide is available from the TI website under literature number SLYU055. Any letter appended to the literature number corresponds to the document revision that is current at the time of the writing of this document. Newer revisions are available from www.ti.com or the Texas Instruments' Literature Response Center at (800) 477-8924 or the Product Information Center at (972) 644-5580. When ordering, identify the document by both title and literature number.

Table 2-3. Related Documentation

Document	Literature Number
TMAG5124 product data sheet	SLYS016

3 Hardware

The TMAG5124EVM is a small form factor, simple-to-use platform for evaluating the main features and performance of the TMAG5124 across a wide voltage range. The EVM features a separate control board that uses the [INA303-Q1](#) that provides instantaneous feedback to the user in the form of LED indication for ON and OFF, and an ALERT state that indicates that the loop is no longer sensing current. The individual TMAG5124 devices are mounted on separable coupon boards, which allows for seamless transition to adapt one of these devices into an existing system for rapid prototyping.

3.1 Features

The layout of the TMAG5124EVM printed-circuit board (PCB) is designed to provide the following features:

- Separates TMAG5124 and control board for testing over distance of wire
- Small form factor board for external testing and prototyping capability
- Provides LED feedback to the user to quickly determine output state from the TMAG5124
- External control board that provides visual output for the correlation of trip points

See the TMAG5124 data sheet (SLYS016) for comprehensive information about the TMAG5124 device.

4 Quick Start

4.1 Option 1: Single 5-V Supply

Follow the procedure listed below to set up and use the TMAG5124EVM with a single 5-V supply:

1. Ensure that plug J5 is shorted.
2. Connect an external 5-V DC supply voltage to the VCC connection point. Ensure the 5-V supply is powered down for now.
3. Connect a wire from "VCC_OUT" on the control board to the "VCC_OUT" port of the TMAG5124 device to be evaluated. Repeat this process for "GND."
4. Turn on the supply. The blue "OFF" light turns on. This indicates that the device is turned on, and current is flowing through the loop.
5. Test the TMAG5124EVM as outlined in section [Section 4.3](#) below.

4.2 Option 2: Separate VCC and 5-V Supply

Follow the procedure listed below to set up and use the TMAG5124EVM with dual supplies, which allows the full VCC range of the TMAG5124 to be tested:

1. Ensure that the shorting plug on J5 is removed.
2. Connect an external 5-V DC supply voltage to the 5-V connection point. Ensure that the 5-V supply is powered down for now.
3. Connect an external DC supply voltage to the VCC connection point, which sets the voltage to the desired level. Ensure this supply is powered down for now.
4. Connect a wire from "VCC_OUT" on the control board to the "VCC_OUT" port of the TMAG5124 device to be evaluated. Repeat this process for "GND."
5. Power on the supply. The blue "OFF" light turns on. This indicates that the device is turned on, and current is flowing through the loop.
6. Test the TMAG5124EVM as outlined in [Section 4.3](#) below.

4.3 Measurements

Note

While TMAG5124 is capable of handling a VCC maximum of 38 V, the INA303-Q1 common mode voltage range may not exceed 36 V to maintain linear operation. TI does not recommend using the control board to evaluate the device inside the 36 V to 38 V range. Testing at this range does not cause damage to either device, but the response from INA303 is not within data sheet specifications.

The TMAG5124EVM enables the user to test the functionality of the TMAG5124 Hall-effect sensor using the onboard hardware or external hardware, which must first be set up as described in [Section 4](#). Then, perform the following:

1. **Trigger the TMAG5124 device output:** Lower the north pole of the included magnet directly over the TMAG5124 Hall-effect sensor.
2. **Observe the operating point:** At the point the magnet crosses the B_{OP} threshold, the "ON" LED (D1) turns on, and the "OFF" LED (D2) turns off.
3. **Observe the release point:** Removing the magnet beyond the release point (B_{RP}), the "ON" LED (D1) turns off, and the "OFF" LED (D2) turns on.
4. **Observe the ALERT state:** Ensure all power supplies are off. Unplug "VCC_OUT" from the control board or the coupon board under test, which "breaks" the loop. Re-energize the power supplies. When the device is not capable of passing current, the control board "ALERT" diode (D3) turns on in place of the "OFF" or "ON" signals.

4.4 Standalone Measurements

It is possible to set up and capture measurements with only a TMAG5124EVM coupon board. This allows testing of the full VCC range of the TMAG5124:

1. Connect an external DC supply voltage to the VCC connection point on the EVM, which sets the voltage to the desired level. Ensure that this supply is powered down for now.
2. Connect a wire from GND on the EVM to a selected resistor value.
3. Connect the remaining side of the resistor to the V- side of the external DC supply. When this is complete, verify that the setup is as shown in [Figure 4-1](#) below.
4. Power on the supply. Based on the selected resistor value, V_{SENSE} changes with the corresponding change in current by [Equation 1](#) below.

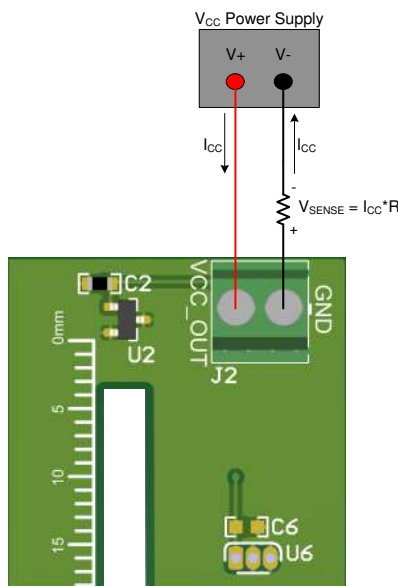

Figure 4-1. TMAG5124EVM Coupon Board Standalone Diagram

$$V_{\text{SENSE}} = I_{\text{CC}} * R \quad (1)$$

5 Circuitry

This section summarizes the TMAG5124EVM subsystems and components.

5.1 TMAG5124 Coupon Boards

The coupon boards are designed to test the complete TMAG5124 family, including in-axis and TO-92 packaged variants.

U1-U4 are TMAG5124E1CQDBZ, TMAG5124F1CQDBZ, TMAG5124G1CQDBZ, and TMAG5124H1CQDBZ versions of the TMAG5124 respectively. These devices allow the user to test all sensitivities of the TMAG5124 (3mT, 6mT, 10mT, and 15mT), with an active low current of 6 mA when a magnet is present at the device. The in-board measurement slot is for a future "in-plane" version of the device.

U5-U8 are for a future option of the device in TO-92 package.

C1-C8 serve as bypass capacitors for the various devices and help to mitigate noise on the power supply supplied to the device.

5.2 Logic, Feedback, and Display

The control board portion of the TMAG5124EVM measures the current in the loop of the TMAG5124, and provides one of three LED feedbacks to the user based on the measured state.

INA303-Q1 is a 36-V common-mode, bidirectional, voltage output current shunt amplifier with integrated window comparator. The device is mainly used here for the window comparator feature, which allows the device to measure three separate states. Current is measured across R1, a precision 3-Ω shunt resistor.

R2, R3, and C10 form a low pass filter for the inputs, as the signal of interest here is mainly a DC signal, and this helps to remove noise on the common mode signal. Note that these resistors have bearing on the gain error of the shunt amplifier, and TI recommends using a value of less than 10 Ω.

R4 and R5 set the limits of the comparator window. The TMAG5124 data sheet explains that for the populated devices, a logic high corresponds to 6 mA, and a logic low corresponds to 12 mA. With this in mind, select resistors using the formula from section 7.3.3.1.1 of the INA303 data sheet:

$$R_{LIMIT} = \frac{I_{TRIP} * R_{SENSE} * GAIN + V_{REF}}{I_{LIMIT}} \quad (2)$$

$$R_{LOW} = \frac{.005 * 3 * 20}{80 E - 06} = 3.75k\Omega \quad (3)$$

$$R_{HIGH} = \frac{.015 * 3 * 20}{80 E - 06} = 11.25 k\Omega \quad (4)$$

Note that for the purposes of error margin, slightly smaller resistance values of 3 kΩ and 10.5 kΩ are used for R4 and R5, respectively.

5.3 J5

J5 is a shorting plug between the 5-V input and VCC input. By shorting this plug, the TMAG5124EVM is powered from a single 5-V supply. If the user wants to evaluate VCC across the full range, ensure that this jumper is removed.

6 Schematic, PCB Layout, and Bill of Materials

Note

Board layouts are not to scale. These figures are intended to show the board layout. The figures are not intended to be used for manufacturing TMAG5124EVM PCBs.

6.1 Schematic

Figure 6-1 shows the schematic for the TMAG5124EVM PCB

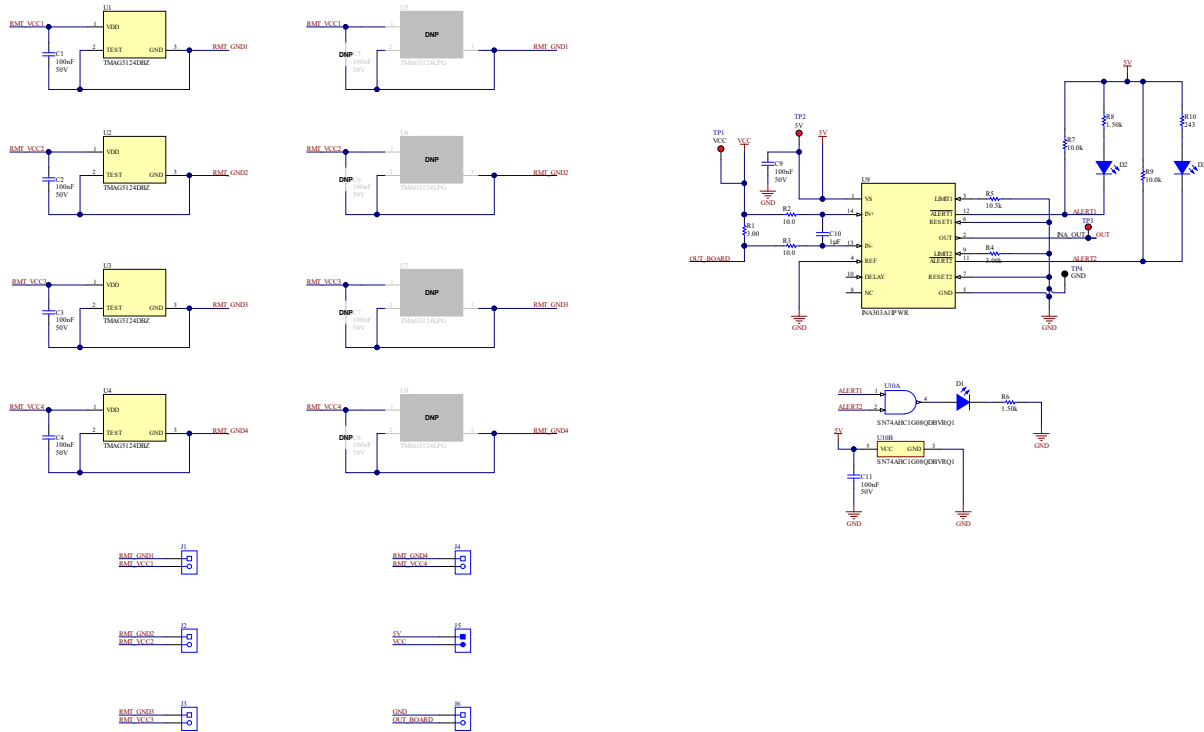

Figure 6-1. TMAG5124EVM Schematic

6.2 PCB Layout

Figure 6-2 through Figure 6-5 show the PCB layout for the TMAG5124EVM.

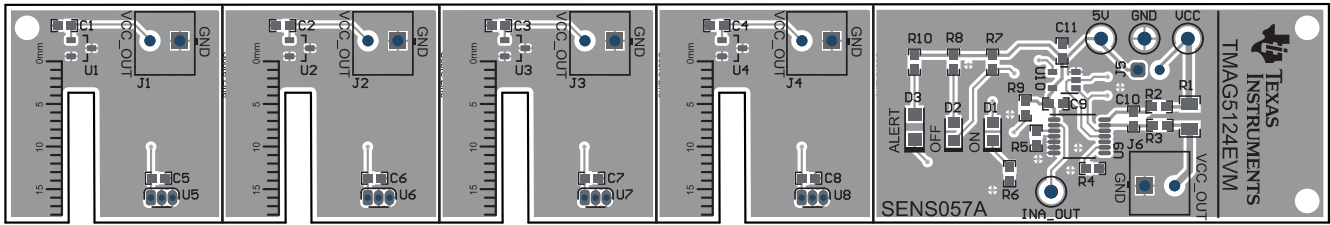

Figure 6-2. TMAG5124EVM Top Overlay

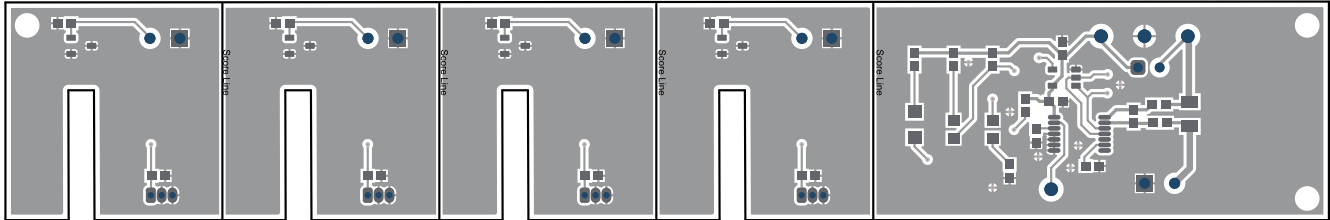

Figure 6-3. TMAG5124EVM Top Layer

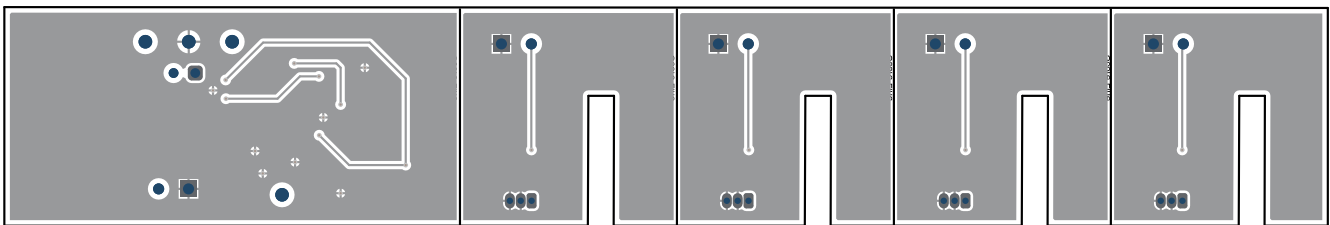

Figure 6-4. TMAG5124EVM Bottom Layer

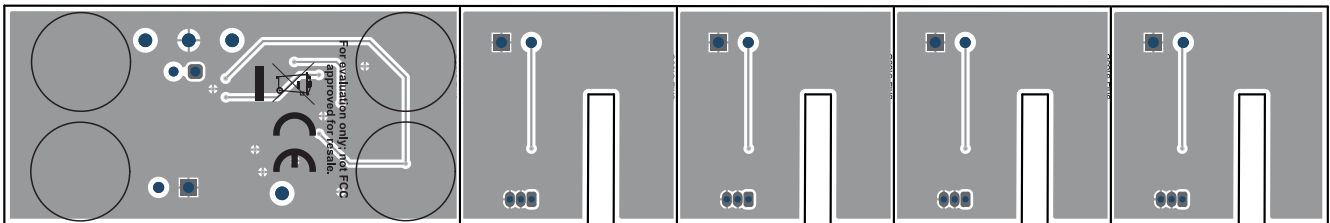

Figure 6-5. TMAG5124EVM Bottom Overlay

6.3 Bill of Materials

To download the bill of materials (BOM), see the design files at <http://www.ti.com/tool/TIDA-00xxX>.

Table 6-1. Bill of Materials

Designator	Qty	Value	Description	Package Reference	Part Number	Manufacturer	Alternate Part Number	Alternate Manufacturer
C1, C2, C3, C4, C9, C11	6	0.1uF	CAP, CERM, 0.1 uF, 50 V, +/- 10%, X7R, AECQ200 Grade 1, 0603	0603	CGA3E2X7R1H104 K080A A	TDK	-	-
C10	1	1uF	CAP, CERM, 1 uF, 50 V, +/- 10%, X7R, 0603	0603	UMK107AB7105KA -T	Taiyo Yuden	-	-
D1,D2	2	Blue	LED, Blue, SMD	LED_0805	150080BS75000	Würth Elektronik	-	-
D3	1	Red	LED, Red, SMD	3.2x1.6mm	150120RS75000	Würth Elektronik	-	-
H1-H4	4		Bumpon, Hemisphere, 0.44 X 0.20, Clear	Transparent Bumpon	SJ-5303 (CLEAR)	3M	-	-
J1 - J4,J6	5		Terminal Block, 3.5mm, 2x1, Tin, TH	Receptacle, 3.5mm, 2x1, TH	691214110002	Würth Elektronik	-	-
J5	1		Header, 2.54 mm, 2x1, Gold, TH	Header, 2.54mm, 2x1, TH	61300211121	Würth Elektronik	-	-
MAG1	1		MAGNET, CYLINDER, 1/8" X 1 1/2", N42, NI		D2X8	KJMagnetics	-	-
R1	1	3.00	RES, 3.00, 1%, 0.25 W, 1206	1206	RC1206FR-073RL	Yageo America	-	-
R2, R3	2	10.0	RES, 10.0, 1%, 0.25 W, AEC-Q200 Grade 0, 0603	0603	CRCW060310R0F KEAHP	Vishay-Dale	-	-
R4	1	3.0k	RES, 3.0 k, 0.1%, 0.1 W, 0603	0603	RG1608P-302-B-T5	Susumu Co Ltd	-	-
R5	1	10.5k	RES, 10.5 k, 0.1%, 0.1 W, 0603	0603	RT0603BRD0710K 5L	Yageo America	-	-
R6, R8	2	1.50k	RES, 1.50 k, 1%, 0.1 W, 0603	0603	ERJ-3EKF1501V	Panasonic	-	-
R7, R9	2	10.0k	RES, 10.0 k, 1%, 0.1 W, AEC-Q200 Grade 0, 0603	0603	CRCW060310K0F KEA	Vishay-Dale	-	-
R10	1	243	RES, 243, 1%, 0.1 W, AEC-Q200 Grade 0, 0603	0603	CRCW0603243RF KEA	Vishay-Dale	-	-

Table 6-1. Bill of Materials (continued)

Designator	Qty	Value	Description	Package Reference	Part Number	Manufacturer	Alternate Part Number	Alternate Manufacturer
SH-J1	1		Shunt, 2.54mm, Gold, Black	Shunt, 2.54mm, Black	60900213421	Würth Elektronik		
TP1-TP3	3		Test Point, Compact, Red, TH	Red Compact Testpoint	5005	Keystone	-	-
TP4	1		Test Point, Compact, Black, TH	Black Compact Testpoint	5006	Keystone	-	-
U1-U4	4		TMAG5124, DBZ0003A (SOT-23-3)	DBZ0003A	TMAG5124DBZ	Texas Instruments	-	Texas Instruments
U9	1		36-V, High-Speed, Bi-Directional, Zero-Drift, Voltage-Output, Current-Shunt Monitor with MultiAlert High-Speed, Overcurrent Comparator, PW0014A (TSSOP-14)	PW0014A	INA303A1PWR	Texas Instruments	INA303A1PW	Texas Instruments
U10	1		Automotive Catalog Single 2-Input Positive-AND Gate, DBV0005A (SOT-23-5)	DBV0005A	SN74AHC1G08QD BVRQ 1	Texas Instruments	-	Texas Instruments
C6 - C8	0	0.1uF	CAP, CERM, 0.1 uF, 50 V, +/- 10%, X7R, AECQ200 Grade 1, 0603	0603	CGA3E2X7R1H104 K080A A	TDK		
U5 - U8	0		TMAG5124LPG, LPG0003A (TO-92-3)		TMAG5124LP G	Texas Instruments		Texas Instruments

7 Revision History

NOTE: Page numbers for previous revisions may differ from page numbers in the current version.

Changes from Revision * (January 2020) to Revision A (November 2020)	Page
• Updated the numbering format for tables, figures, and cross-references throughout the document.....	1
• Changed values of R4 and R5 to adjust comparator limit parameters.....	10

IMPORTANT NOTICE AND DISCLAIMER

TI PROVIDES TECHNICAL AND RELIABILITY DATA (INCLUDING DATA SHEETS), DESIGN RESOURCES (INCLUDING REFERENCE DESIGNS), APPLICATION OR OTHER DESIGN ADVICE, WEB TOOLS, SAFETY INFORMATION, AND OTHER RESOURCES "AS IS" AND WITH ALL FAULTS, AND DISCLAIMS ALL WARRANTIES, EXPRESS AND IMPLIED, INCLUDING WITHOUT LIMITATION ANY IMPLIED WARRANTIES OF MERCHANTABILITY, FITNESS FOR A PARTICULAR PURPOSE OR NON-INFRINGEMENT OF THIRD PARTY INTELLECTUAL PROPERTY RIGHTS.

These resources are intended for skilled developers designing with TI products. You are solely responsible for (1) selecting the appropriate TI products for your application, (2) designing, validating and testing your application, and (3) ensuring your application meets applicable standards, and any other safety, security, regulatory or other requirements.

These resources are subject to change without notice. TI grants you permission to use these resources only for development of an application that uses the TI products described in the resource. Other reproduction and display of these resources is prohibited. No license is granted to any other TI intellectual property right or to any third party intellectual property right. TI disclaims responsibility for, and you will fully indemnify TI and its representatives against, any claims, damages, costs, losses, and liabilities arising out of your use of these resources.

TI's products are provided subject to [TI's Terms of Sale](#) or other applicable terms available either on ti.com or provided in conjunction with such TI products. TI's provision of these resources does not expand or otherwise alter TI's applicable warranties or warranty disclaimers for TI products.

TI objects to and rejects any additional or different terms you may have proposed.

Mailing Address: Texas Instruments, Post Office Box 655303, Dallas, Texas 75265
Copyright © 2022, Texas Instruments Incorporated