

Differential CATV Variable Gain Amplifier 5 - 300 MHz

Rev. V3

Features

- 39 dB Gain
- 31.5 dB, 0.5 dB steps, 6 Bit Digital Step Attenuator
- 36 dB MER, 64 QAM 39 Channels, 52 dBmV/ch.
- 8 V or 5 V Operation
- 3 dB Noise Figure
- Serial or Parallel Attenuator Control
- Differential Input and Output
- Low Harmonics
- Power Down Mode
- Lead-Free 7 mm 48-Lead PQFN
- Halogen-Free “Green” Mold Compound
- RoHS* Compliant

Description

The MAAM-011186 is an integrated 2 stage differential amplifier with embedded digital step attenuator (DSA) assembled in a lead-free 7 mm 48-lead PQFN package.

This amplifier provides excellent linearity and high output power with greater than 30 dB MER for 64 QAM modulation with 39 channels and 52 dBmV per channel. Gain in the minimum attenuation state is typically 39 dB. The internal DSA offers 31.5 dB attenuation range with 0.5 dB steps. This device is optimized for high output power and low current from 8 V bias but can also be operated from 5 V bias with flexibility to adjust DC current with external components. The module provides a power down function for each of the amplifier stages.

This amplifier is ideally suited for use in CATV reverse path applications.

Ordering Information^{1,2}

Part Number	Package
MAAM-011186-TR1000	1000 piece reel
MAAM-011186-TR3000	3000 piece reel
MAAM-011186-001SMB	Sample Test Board, 8 V
MAAM-011186-002SMB	Sample Test Board, 5 V

1. Reference Application Note M513 for reel size information.
2. All sample boards include 5 loose parts.

* Restrictions on Hazardous Substances, European Union Directive 2011/65/EU.

Functional Schematic

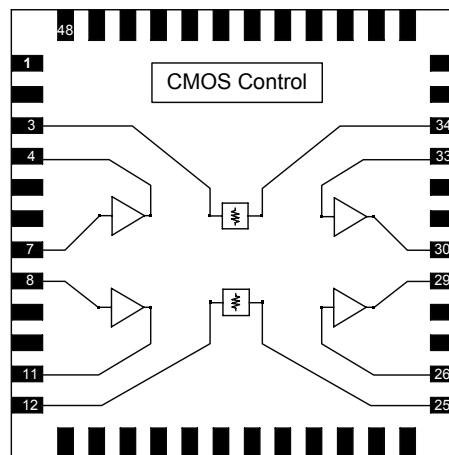

Pin Configuration³

Pin No.	Description	Pin No.	Description
1	Latch Enable	30	Stage 2 Output (+)
3	Attenuator Input (+)	32	Stage 2 Feedback (+)
4	Stage 1 Output (+)	33	Stage 2 Input (+)
6	Stage 1 Feedback (+)	34	Attenuator Output (+)
7	Stage 1 Input (+)	36	DSA Serial Output
8	Stage 1 Input (-)	37	Power Up Select 2
9	Stage 1 Feedback (-)	38	Power Up Select 1
11	Stage 1 Output (-)	39	V _{DD} CMOS Controller
12	Attenuator Input (-)	40	Attenuator Bit 5 (16 dB)
16	Enable Stage 1	41	Attenuator Bit 4 (8 dB)
18	Stage 1 Bias Voltage	42	Attenuator Bit 3 (4 dB)
19	Stage 2 Bias Voltage	43	Attenuator Bit 2 (2 dB)
21	Enable Stage 2	44	Attenuator Bit 1 (1 dB)
25	Attenuator Output (-)	45	Attenuator Bit 0 (0.5 dB)
26	Stage 2 Input (-)	46	Parallel/Serial Select
27	Stage 2 Feedback (-)	47	Clock
29	Stage 2 Output (-)	48	Serial Input
		49	RF and DC Ground ⁴

3. All pins not listed in the table are “No Connection” and should be left unconnected.
4. The exposed pad centered on the package bottom must be connected to RF and DC ground.

Differential CATV Variable Gain Amplifier 5 - 300 MHz

Rev. V3

Electrical Specifications: $T_A = +25^\circ\text{C}$, $V_{CC} = 8\text{ V}$, Minimum attenuation state, $Z_0 = 75\ \Omega$

Parameter	Test Conditions	Units	Min.	Typ.	Max.
Gain	Max. Gain State @ 100 MHz, -29 dBm P_{IN}	dB	37.5	39.0	41.0
Gain Slope	Positive tilt from 5 - 250 MHz	dB	—	1.2	—
Noise Figure ⁵	—	dB	—	3.0	—
Input Return Loss	—	dB	—	22	—
Output Return Loss	—	dB	—	22	—
Reverse Isolation	—	dB	—	50	—
Attenuation Range	100 MHz relative to max. attenuation gain, -29 dBm P_{IN}	dB	30.0	31.5	33.0
64 QAM MER ⁶	39 Channels (5-250 MHz), 52 dBmV/Ch. Single Channel (8-200 MHz), 72 dBmV/Ch. Single Channel (250 MHz), 71 dBmV/Ch. 16 Channels (5-250 MHz), 57 dBmV/Ch.	dB	— 30 — 30	36 35 35 34	—
P1dB	—	dBm	—	27	—
OIP2	2-tone, 12 dBm/tone, 1 MHz tone spacing, 200 MHz	dBm	—	70	—
OIP3	2-tone, 12 dBm/tone, 1 MHz tone spacing, 200 MHz	dBm	—	42	—
T_{ON} , T_{OFF}	50% Control to 90 / 10 % RF	ns	—	400	—
I_{CC}	EN1 = EN2 = 5 V	mA	—	280	315
I_{CC_OFF}	EN1 = EN2 = 0 V	mA	—	3	5
I_{EN1} , I_{EN2}	EN1 = EN2 = 5 V	mA	—	0.7	—

5. Includes Balun Loss.

6. Modulation error ratio each channel 64 QAM 5.12 MS/s.

Absolute Maximum Ratings^{7,8,9}

Parameter	Absolute Maximum
RF Input Power	-8 dBm
Voltage	10 Volts
Control Voltage	-0.5 to +5.5 Volts
Junction Temperature ¹⁰	+150°C
Operating Temperature	-40°C to +100°C
Storage Temperature	-65°C to +150°C

7. Exceeding any one or combination of these limits may cause permanent damage to this device.

8. M/A-COM Technology Solutions does not recommend sustained operation near these survivability limits.

9. Operating at nominal conditions with $T_J \leq 150^\circ\text{C}$ will ensure $MTTF > 1 \times 10^6$ hours.

10. Junction Temperature (T_J) = $T_C + \Theta_{jc} * (V * I)$
Typical thermal resistance (Θ_{jc}) = 9° C/W.

a) For $T_C = +25^\circ\text{C}$,
 $T_J = 47^\circ\text{C}$ @ 8 V, 315 mA

b) For $T_C = +100^\circ\text{C}$,
 $T_J = 122^\circ\text{C}$ @ 8 V, 315 mA

Truth Table¹¹

B5	B4	B3	B2	B1	B0	Attenuation (dB)
1	1	1	1	1	1	Minimum
1	1	1	1	1	0	0.5
1	1	1	1	0	1	1
1	1	1	0	1	1	2
1	1	0	1	1	1	4
1	0	1	1	1	1	8
0	1	1	1	1	1	16
0	0	0	0	0	0	31.5

11. Logic "0" = 0.0 V to 0.8 V \pm 0.2 V,
Logic "1" = 2.0 V to 5.0 V \pm 0.2 V

Differential CATV Variable Gain Amplifier 5 - 300 MHz

Rev. V3

PCB Layout

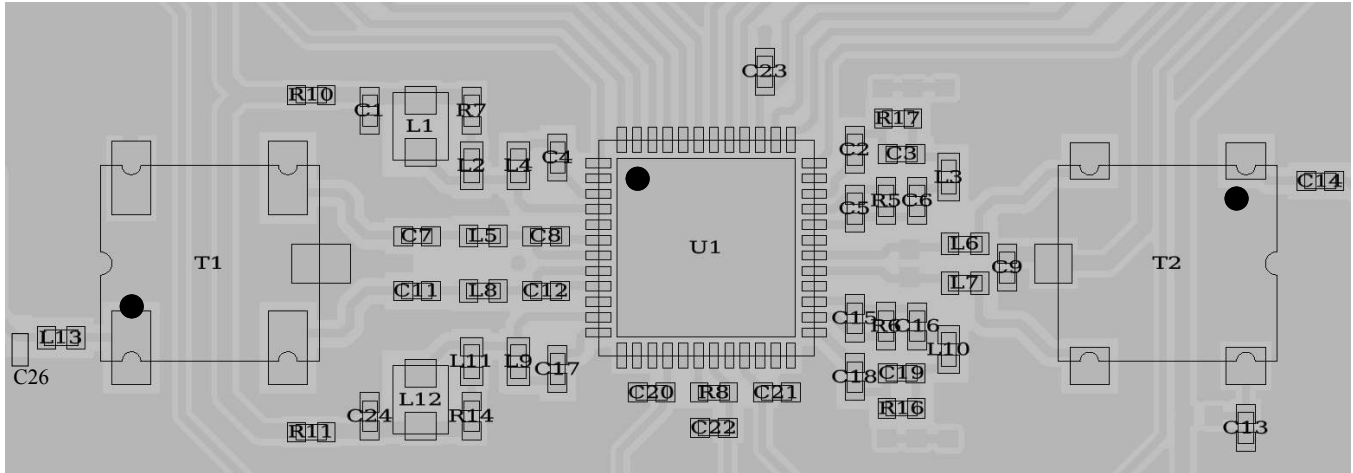

Application Schematic

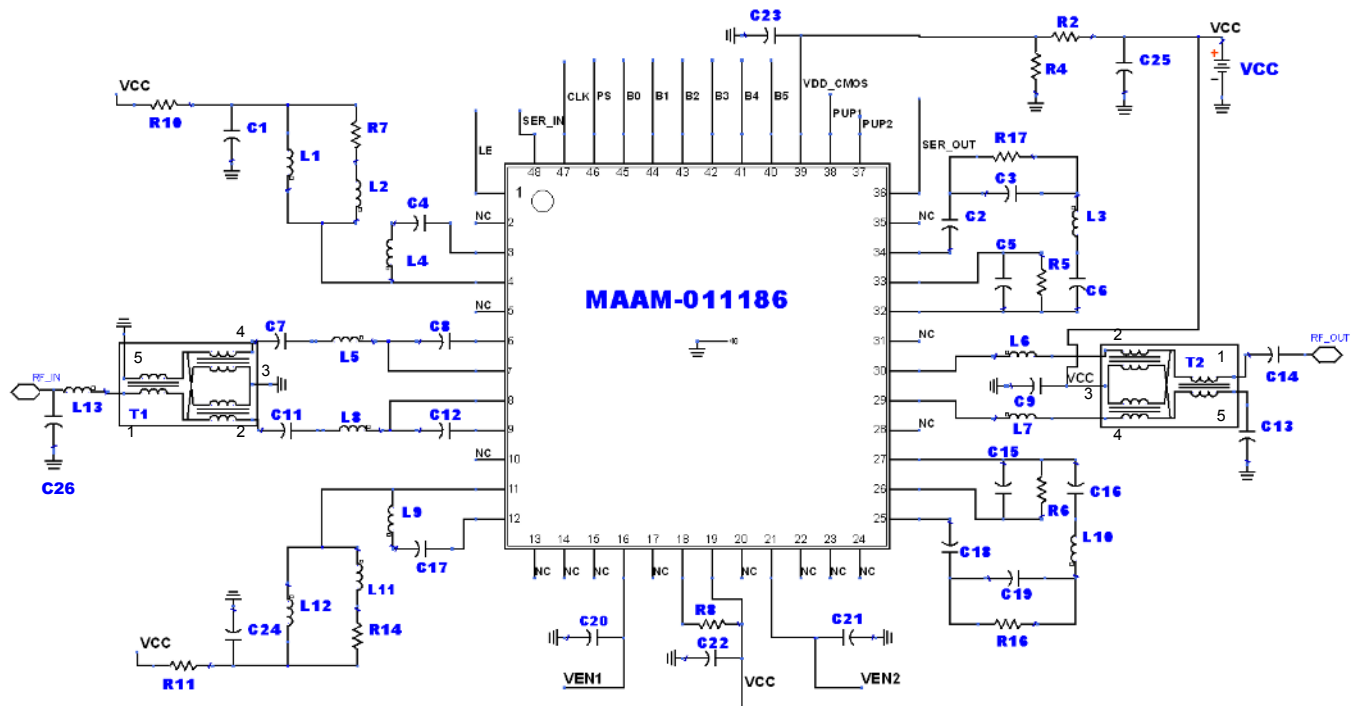

Differential CATV Variable Gain Amplifier 5 - 300 MHz

Rev. V3

Parts List : 8 V Application circuit

Part	Value	Case Style	Function/Notes
C1, C9, C13, C20, C21, C22, C23, C24	0.1 μ F	0402	RF Bypass
C2, C4, C5, C6, C7, C8, C11, C12, C14, C15, C16, C17, C18	0.1 μ F	0402	DC Block
C3, C19	47 pF	0402	Gain Tilt (with R16 and R17)
C25	1 μ F	0805	Low Frequency Bypass
C26	DNI (Do not install)	0402	Input Match
L1, L12	47 μ H	0806	Stage1 V_{CC} Choke. Murata LQH2MCN470K02L
L2, L11	250 nH	0402	Gain Tilt (With R7 & R14). Coilcraft 0402AF-251XJLU
L3, L10	18 nH	0402	Input Match Stage2 Amp
L4, L9	8.2 nH	0402	Output Match Stage1 Amp
L5, L8	27 nH	0402	Input Match Stage2 Amp
L6, L7	30 nH	0402	Output Match Stage2 Amp
L13	5.6 nH	0402	Input Match
R2 ¹²	3 k Ω	0402	Voltage Divider for V_{DD} CMOS
R4 ¹²	5 k Ω	0402	Voltage Divider for V_{DD} CMOS
R7, R14	249 Ω	0402	Gain Tilt (with L2 & L11)
R16, R17	27 Ω	0402	Gain Tilt (with C3 & C19)
R8	10 k Ω	0402	Set Current for Stage1 Amp. Lower to Reduce Current.
R10, R11	100 Ω	0402	Drop V_{CC1} to 5 V. P_{DISS} 1/10 W
R5, R6	DNI (Do not install)	-	May be used to increase Stage 2 current for lower V_{CC} applications.
T1, T2	1:2		MABA-011029 (MABA-011050 alternate) ¹³

12. These components may be omitted if direct connection to 3 - 5 V bias is available for V_{DD_CMOS} .

13. If using MABA-011050 balun: L5,L8 = 30 nH, L6,L7= 33 nH, C26 = 1 pF.

Differential CATV Variable Gain Amplifier 5 - 300 MHz

Rev. V3

Typical Performance Curves: $V_{CC} = 8\text{ V}$

Gain

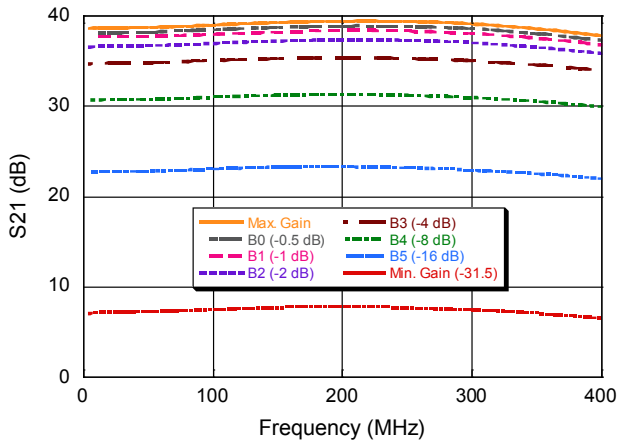

Gain - Wideband

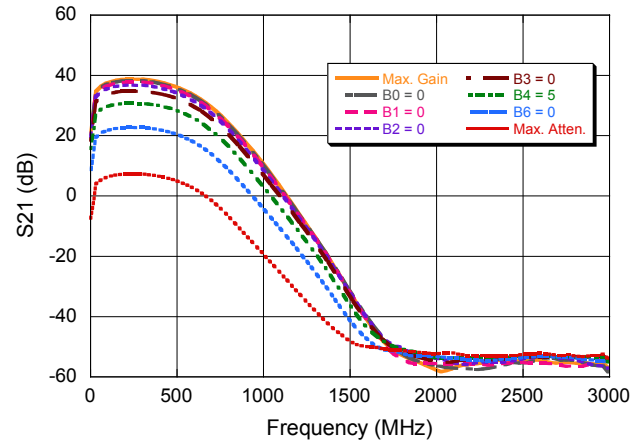

Input Return Loss

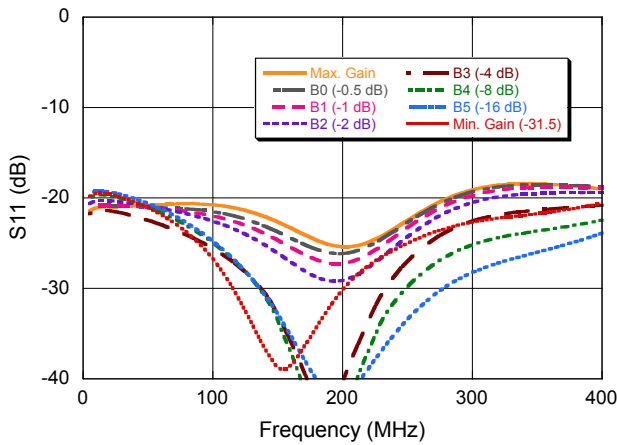

Output Return Loss

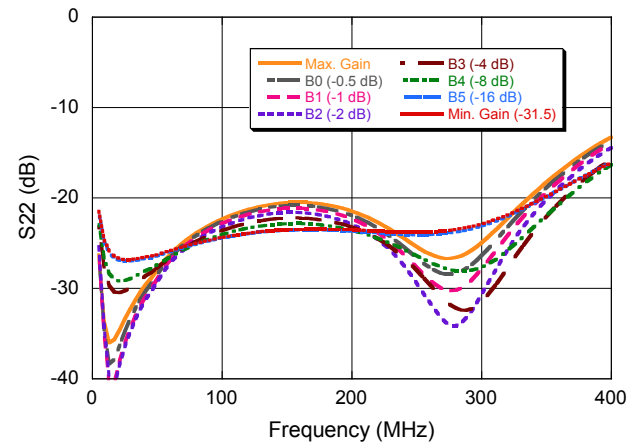

Reverse Isolation

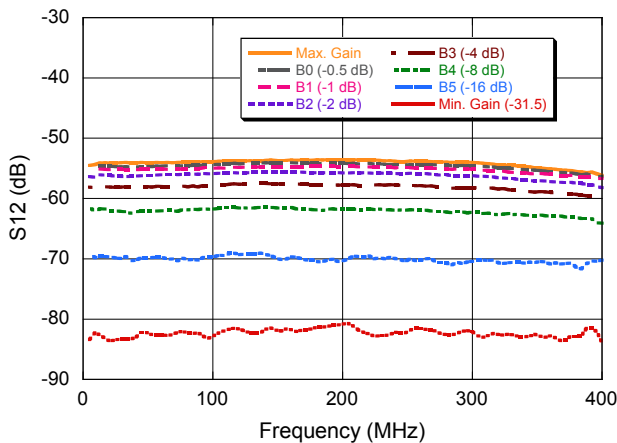

Noise Figure

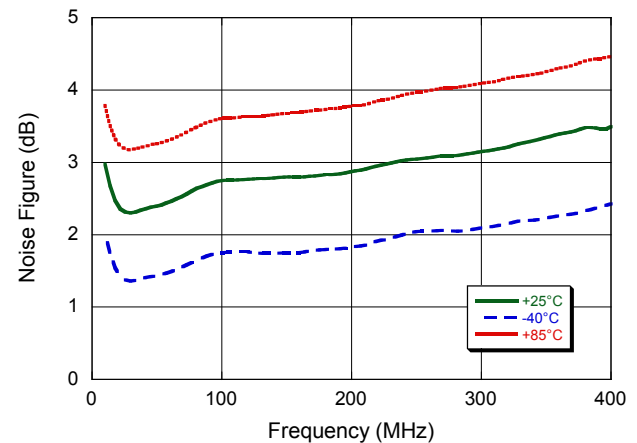

Differential CATV Variable Gain Amplifier 5 - 300 MHz

Rev. V3

Typical Performance Curves: $V_{CC} = 8\text{ V}$

Gain

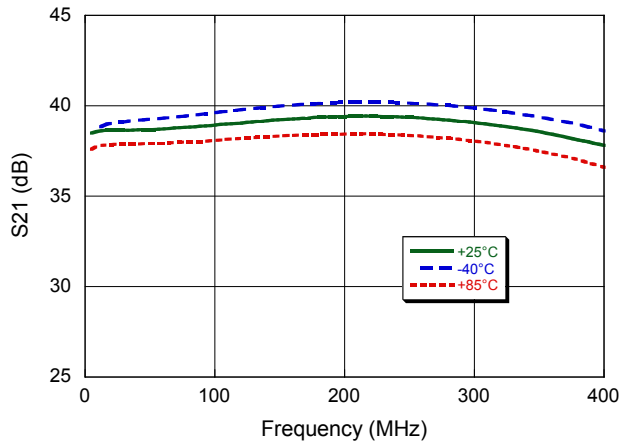

P_{OUT} @ 30 dB MER

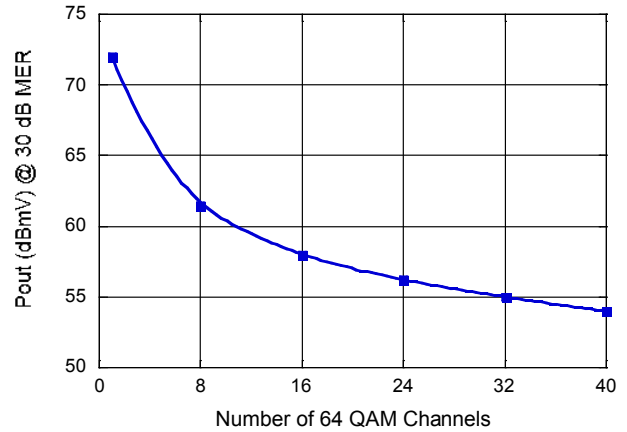

Modulation Error Ratio (64 QAM, single channel)

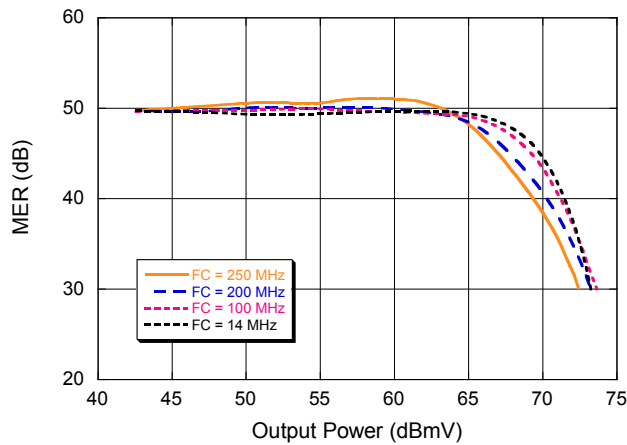

Modulation Error Ratio (64 QAM, 16 channel)

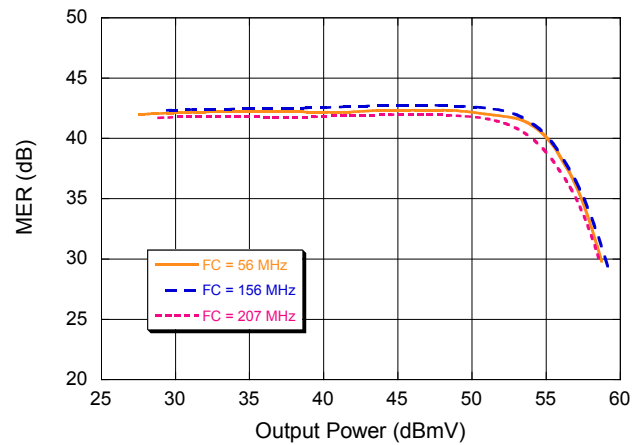

Modulation Error Ratio (64 QAM, 32 channel)

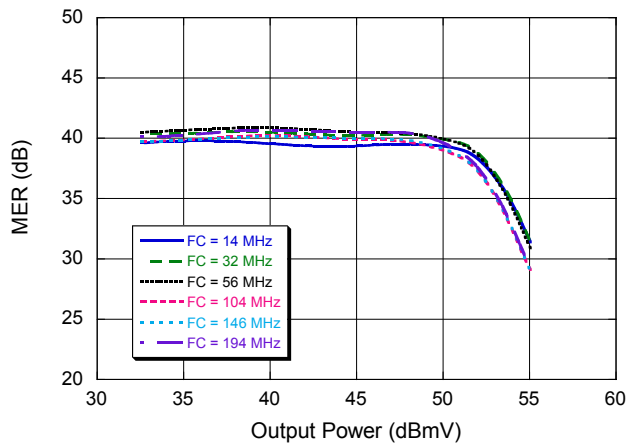

Modulation Error Ratio (64 QAM, 40 channel)

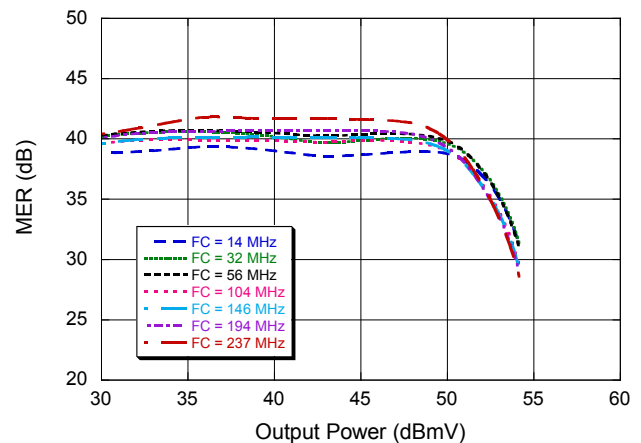

Differential CATV Variable Gain Amplifier 5 - 300 MHz

Rev. V3

Lead-Free 7 mm 48-lead PQFN

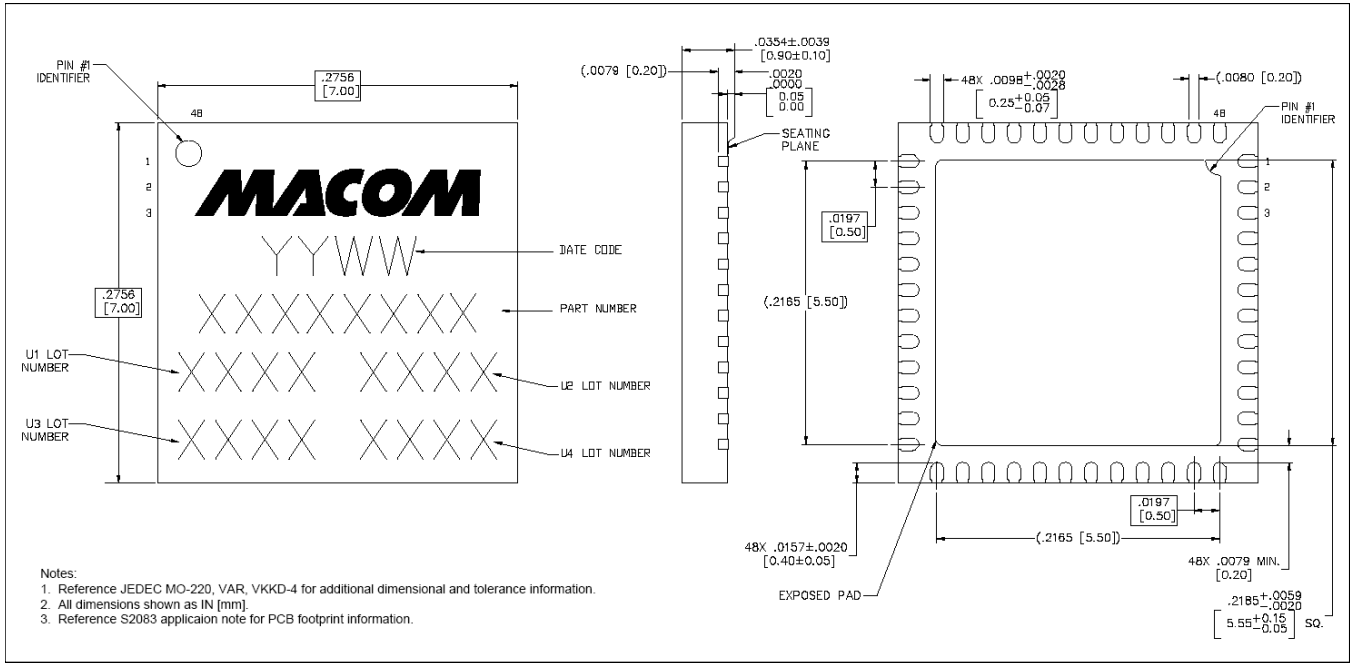

† Reference Application Note S2083 for lead-free solder reflow recommendations.
Meets JEDEC moisture sensitivity level 1 requirements.
Plating is NiPdAuAg.

Recommended Land Pattern

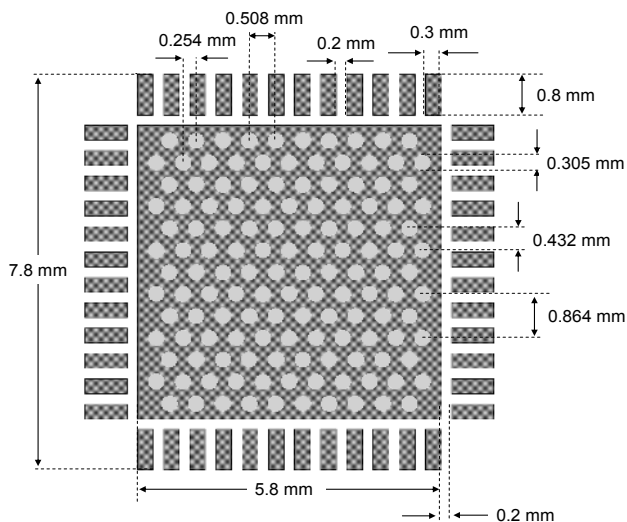

Copper plating (board and vias) should be ≥ 0.05 mm thick.

Handling Procedures

Please observe the following precautions to avoid damage:

Static Sensitivity

Gallium Arsenide Integrated Circuits are sensitive to electrostatic discharge (ESD) and can be damaged by static electricity. Proper ESD control techniques should be used when handling these HBM Class 1B devices.

Applications Section

5 V Application

The MAAM-011186 may also be operated from 5 V V_{CC} supply with adjustment of a few external components. Resistors R5 and R6 may be used to increase output stage current and output power.

Typical Performance: $T_A = +25^\circ\text{C}$, $V_{CC} = 5\text{ V}$, Minimum attenuation state, $Z_0 = 75\ \Omega$

Parameter	Test Conditions	Units	Typ.
Gain	Max. Gain State @ 100 MHz, -29 dBm P_{IN}	dB	39
Gain Slope	Positive tilt from 5 - 250 MHz	dB	1.2
Noise Figure	—	dB	3.0
Input Return Loss	—	dB	22
Output Return Loss	—	dB	22
Reverse Isolation	—	dB	50
Attenuation Range	100 MHz relative to max. attenuation gain, -29 dBm P_{IN}	dB	31.5
64 QAM MER ⁶	16 Channels (5 - 250 MHz), 53 dBmV/Ch.	dB	34
P1dB	—	dBm	23
OIP2	2-tone, 6 dBm/tone, 1 MHz tone spacing, 200 MHz	dBm	70
OIP3	2-tone, 6 dBm/tone, 1 MHz tone spacing, 200 MHz	dBm	37
I_{CC}	EN1 = EN2 = 5 V (R5 = R6 = 7.5 k Ω)	mA	190

Typical Performance Curves: $V_{CC} = 5\text{ V}$

Modulation Error Ratio (64 QAM, 16 channel)

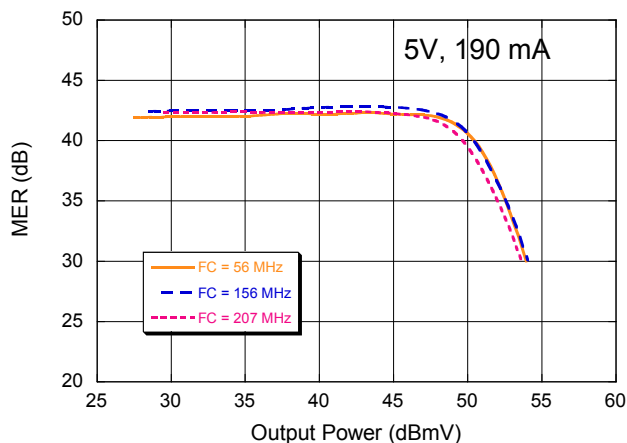

Modulation Error Ratio (64 QAM, 16 channel)

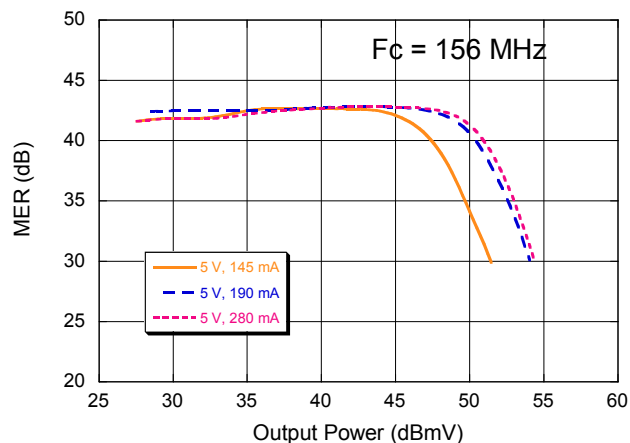

Differential CATV Variable Gain Amplifier 5 - 300 MHz

Rev. V3

Parts List¹⁴: 5 V Application circuit, 190 mA typical

Part	Value	Case Style	Function/Notes
C1, C9, C13, C20, C21, C22, C23, C24	0.1 μ F	0402	RF Bypass
C2, C4, C5, C6, C7, C8, C11, C12, C14, C15, C16, C17, C18	0.1 μ F	0402	DC Block
C3, C19	47 pF	0402	Gain Tilt (with R16 and R17)
C25	1 μ F	0805	Low Frequency Bypass
C26	1 pF	0402	Input Match
L1, L12	47 μ H	0806	Stage1 V _{CC} Choke. Murata LQH2MCN470K02L
L2, L11	250 nH	0402	Gain Tilt (With R7 & R14). Coilcraft 0402AF-251XJLU
L3, L10	18 nH	0402	Input Match Stage2 Amp
L4, L9	8.2 nH	0402	Output Match Stage1 Amp
L5, L8	30 nH	0402	Input Match Stage2 Amp
L6, L7	33 nH	0402	Output Match Stage2 Amp
L13	5.6 nH	0402	Input Match
R2	0 Ω	0402	Voltage Divider for V _{DD} CMOS
R4	DNI	0402	Voltage Divider for V _{DD} CMOS
R7, R14	249 Ω	0402	Gain Tilt (with L2 & L11)
R16, R17	27 Ω	0402	Gain Tilt (with C3 & C19)
R8	0 Ω	0402	Set Current for Stage1 Amp. Lower to Reduce Current.
R10, R11	0 Ω	0402	Drop V _{CC1} to 5 V. P _{DISS} 1/10 W
R5, R6 ¹⁴	7.5 k Ω	-	Set current for Stage 2 Amp.
T1, T2	1:2		MABA-011050

14. With resistor R5 & R6 installed Stage 2 current will not be fully shut down when EN2 = 0

Total Current vs. R5, R6 Resistor Value (R8 = 0 Ω)

R5, R6 Value	Total Current
DNI	145 mA
7.5 k Ω	190 mA
4.3 k Ω	210 mA
1.5 k Ω	275 mA

9

MACOM Technology Solutions Inc. (MACOM) and its affiliates reserve the right to make changes to the product(s) or information contained herein without notice. Visit www.macom.com for additional data sheets and product information.

Functionality Modes of Operation: Serial, Direct Parallel, and Latched Parallel

Mode Truth Table

P/S	LE	Mode
1	X	Serial
0	Constant High	Direct Parallel
0	Pulsed	Latched Parallel

Serial Mode

The serial control interface (SERIN, CLK, LE, SEROUT) is compatible with the SPI protocol. SPI mode is activated when P/S is kept high. The 6-bit serial word must be loaded with MSB first. After shifting in the 6 bit word, bringing LE high will set the attenuator to the desired state. While LE is high the CLK is masked to protect the data while implementing the change. SEROUT is the SERIN delayed by 6 clock cycles.

When P/S is low, the serial control interface is disabled and the serial input register is loaded asynchronously with parallel digital inputs.

Direct Parallel Mode

The parallel mode is enabled when P/S is set to low. In the direct parallel mode, the attenuator is controlled by the parallel control inputs directly. The LE must be at logic high to control the attenuator in this mode.

Latched Parallel Mode

In the latched parallel mode, the parallel control inputs will be buffered by registers, and loaded to the outputs when LE is high. The outputs shall not change states when LE is low.

Power-up States

The power-up (PUP) states will work in both serial and parallel modes, and initiate the attenuator according to the PUP truth table. During power up, the digital inputs shall be held constant for at least 1 μ s after V_{CC} reaches 90% of final value. For serial mode, the PUP states will only work when LE is held low. The PUP state shall be locked out after the first LE pulse. Proper operation of power up states requires fast rise time (<200 ns) for $V_{DD-CMOS}$.

Functionality
Modes of Operation: Serial, Direct Parallel, and Latched Parallel

PUP Truth Table

Inputs				Gain Relative to Max. Gain	Notes
PS	LE	PUP2	PUP1		
0	0	0	0	-31.5 dB	Parallel Mode
0	0	0	1	-24 dB	
0	0	1	0	-16 dB	
0	0	1	1	0 dB	
0	1	X	X	0 to -31.5 dB (Set B0 - B5)	Serial Mode
1	0	X	X	0 to -31.5 dB (Set B0 - B5)	
1	1	X	X	No Definition	

Serial Interface Timing Characteristics

Symbol	Parameter	Typical Performance			Units
		-40°C	25°C	+85°C	
t _{SK}	Min. Serial Clock Period	100	100	100	ns
t _{CS}	Min. Control Set-up Time	20	20	20	ns
t _{CH}	Min. Control Hold Time	20	20	20	ns
t _{LS}	Min. LE Set-up Time	10	10	10	ns
t _{LEW}	Min. LE Pulse Width	10	10	10	ns
t _{LH}	Min. Serial Clock Hold Time from LE	10	10	10	ns
t _{LES}	Min. LE Pulse Spacing	630	630	630	ns

Functionality Modes of Operation: Serial, Direct Parallel, and Latched Parallel

Serial Input Interface Timing Diagram

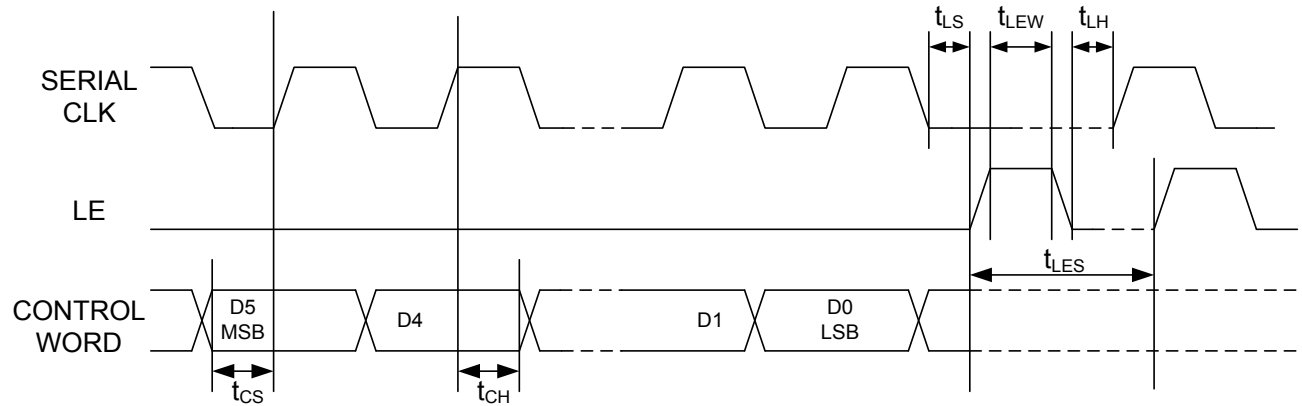

Parallel Control Word

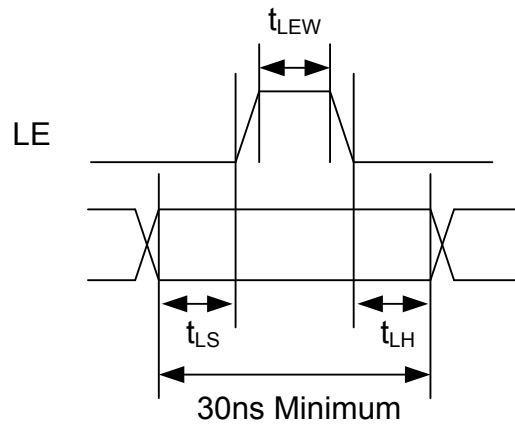

MACOM Technology Solutions Inc. All rights reserved.

Information in this document is provided in connection with MACOM Technology Solutions Inc ("MACOM") products. These materials are provided by MACOM as a service to its customers and may be used for informational purposes only. Except as provided in MACOM's Terms and Conditions of Sale for such products or in any separate agreement related to this document, MACOM assumes no liability whatsoever. MACOM assumes no responsibility for errors or omissions in these materials. MACOM may make changes to specifications and product descriptions at any time, without notice. MACOM makes no commitment to update the information and shall have no responsibility whatsoever for conflicts or incompatibilities arising from future changes to its specifications and product descriptions. No license, express or implied, by estoppel or otherwise, to any intellectual property rights is granted by this document.

THESE MATERIALS ARE PROVIDED "AS IS" WITHOUT WARRANTY OF ANY KIND, EITHER EXPRESS OR IMPLIED, RELATING TO SALE AND/OR USE OF MACOM PRODUCTS INCLUDING LIABILITY OR WARRANTIES RELATING TO FITNESS FOR A PARTICULAR PURPOSE, CONSEQUENTIAL OR INCIDENTAL DAMAGES, MERCHANTABILITY, OR INFRINGEMENT OF ANY PATENT, COPYRIGHT OR OTHER INTELLECTUAL PROPERTY RIGHT. MACOM FURTHER DOES NOT WARRANT THE ACCURACY OR COMPLETENESS OF THE INFORMATION, TEXT, GRAPHICS OR OTHER ITEMS CONTAINED WITHIN THESE MATERIALS. MACOM SHALL NOT BE LIABLE FOR ANY SPECIAL, INDIRECT, INCIDENTAL, OR CONSEQUENTIAL DAMAGES, INCLUDING WITHOUT LIMITATION, LOST REVENUES OR LOST PROFITS, WHICH MAY RESULT FROM THE USE OF THESE MATERIALS.

MACOM products are not intended for use in medical, lifesaving or life sustaining applications. MACOM customers using or selling MACOM products for use in such applications do so at their own risk and agree to fully indemnify MACOM for any damages resulting from such improper use or sale.