

REV.	DESCRIPTION	DATE
A	New Drawing	2013/11/27

Compliance with:
 PCIe4.0(GT/S),
 USB4 Gen3(40Gbps),
 USB3.2 Gen2(10Gbps).
 Mating with:
 "BBAD-030G1145NOLI-B"

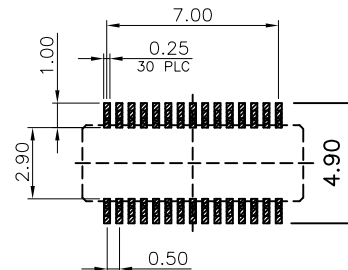
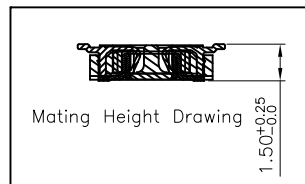
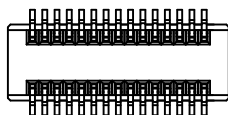
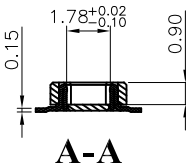
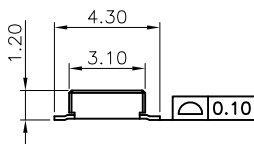
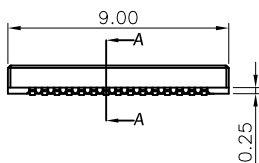
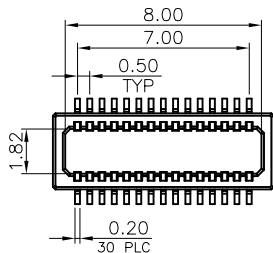

▨ : STAND OFF AREA

P.C.B LAYOUT

RoHS compliant

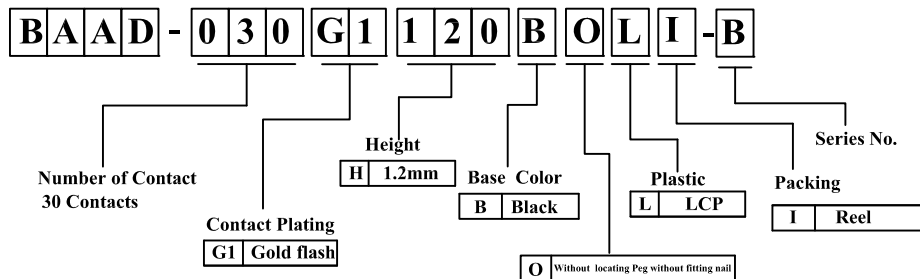

Superior Tech Co., Ltd.

General Tolerance		TITLE	PH0.5 BTOB H1.2 30PIN Female	
X.	± 0.5	DRAWN	DATE	NO.
.X	± 0.3	Tom	11-27-13'	002
.XX	± 0.2	CHECK	DATE	PART NO.
.XXX	± 0.1	APPROVED	DATE	BAAD-030G1120BOLI-B
Angle	± 5°			CUSTOMER NO. DK

REV.	UNIT	SCALE
A	mm	1:1

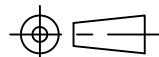

REV.	DESCRIPTION	DATE
A	New Drawing	2013/12/09

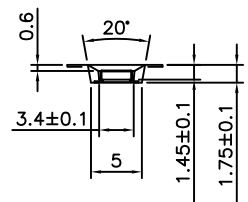
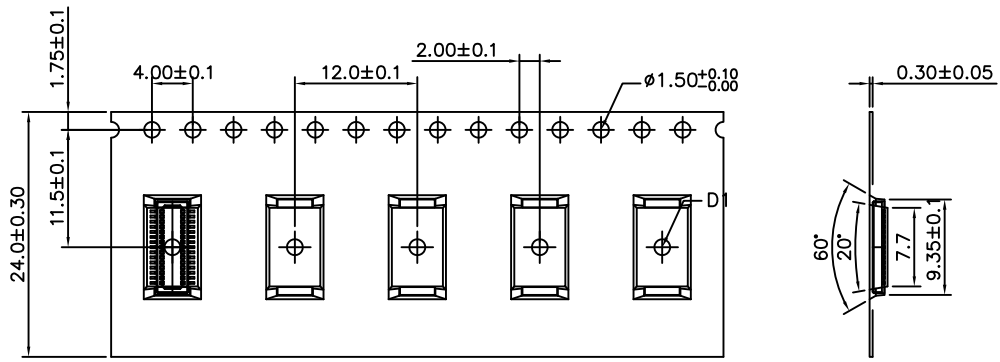
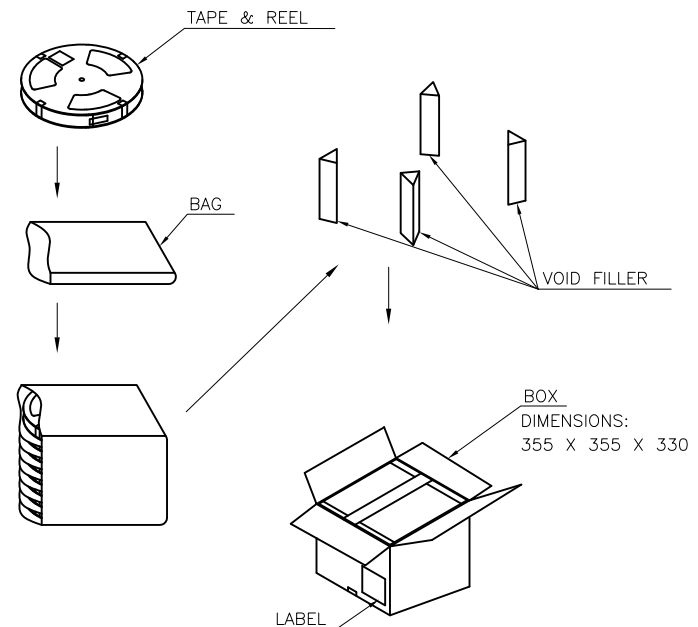
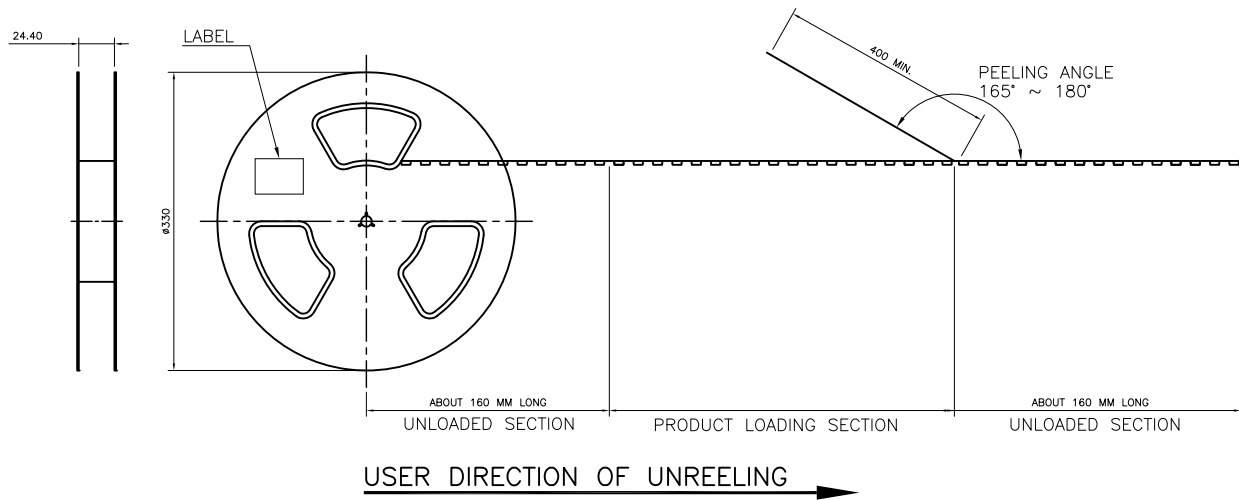

Note:
 1.All dimensions meet EIA-481-C requirements.
 2.Thickness : 0.3±0.05mm

PIN No.	PCS/R	R/CTN
30PIN	2800 PCS	11 R

Superior Tech Co., Ltd.

General Tolerance		TITLE	BAAD-030G1120BOLI-B-Packing	
X. ± 0.5		DRAWN Tom	DATE	NO.
.X ± 0.3			2013/12/09	002
.XX ± 0.2		CHECK	DATE	PART NO.
.XXX ± 0.1		APPROVED	DATE	BAAD-030G1120BOLI-B
Angle	± 5°			CUSTOMER NO.

REV. A	UNIT mm	SCALE 1:1	
------------------	-------------------	---------------------	--

(Q2-R03-01A) ST-R05-07