

Protected

→ 83 154

- Double break switching
- High DC switch rating
- Choice of actuators and fixing positions



Main specifications

		Magnetic blow-out 83 154 0
Function	Connections	
I (changeover)	W1 - W2 - W3	●
R (normally closed)	W1 - W2 - W3	●
C (normally open)	W1 - W2 - W3	●
Electrical characteristics		
Rating nominal / 250 V DC (A)		5
Rating thermal / 250 V DC (A)		17.5
Mechanical characteristics		
Maximum operating force (N)		4
Min. Release force (N)		1
Tripping point (mm)		20
Min. overtravel (mm)		0.7
Mechanical life (operations)		10 ⁷
Max. permitted overtravel force (N)		20
Rest position max. (mm)		-
differential travel (mm)		0.65 ^{+0.25}
Ambient operating temperature (°C)		-40 → +125
Contact gap (mm)		0.5 x 2
Weight (g)		11
Comments		
At 250 VDC 5 A resistive 500.000 cycles		

Additional specifications

Components

Material

- Case : polyamide UL94V0
- Contacts : nickel silver

Levers

- Mild steel (zinc)
- Roller : polyamide
- Adjusting screws : self-retaining
- Plates : iridescent passivated mild steel (zinc)

Product adaptations



- Special levers
- Reinforced spring
- Special contacts
- Approvals : UL - cUL

Principles

Single break changeover switch



Dimensions

→ Product

83 154 0

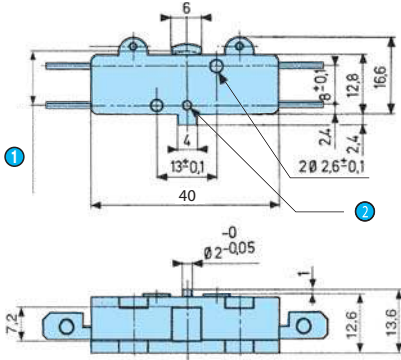

① OL = 10.65

② $\varnothing 2^{+0.01 +0.65}$ Depth 1.2

→ Connections

W1 screw

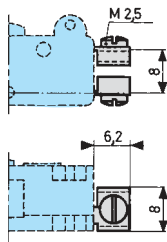

W2 solder

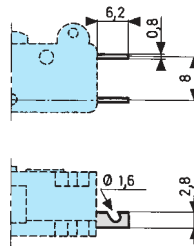

W3 for 6.35 mm clips

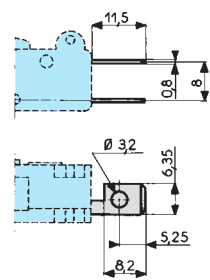

→ Actuators

A

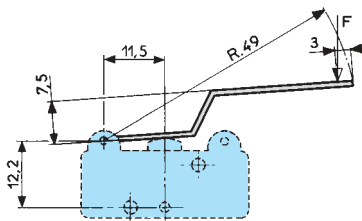

Lever cross-section 1 x 6.4 mm

B

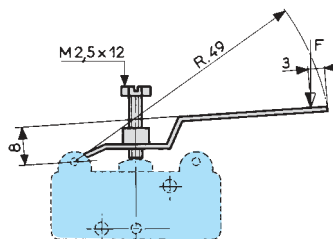

Lever cross-section 1 x 6.4 mm

E

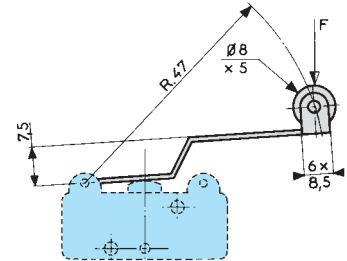

Lever cross-section 1 x 6.4 mm

Q

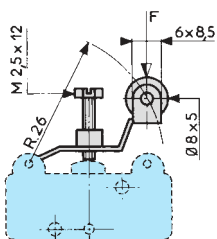

Lever cross-section 1 x 6.4 mm

B9

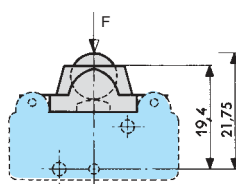

V3

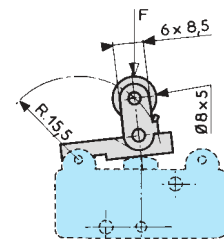

Lever cross-section 1 x 6.4 mm

→ Mounting accessories

Y
Side plate

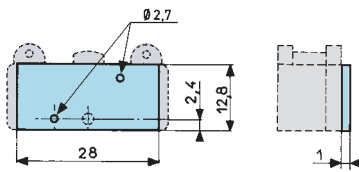

O2
2-pole side mounting plate

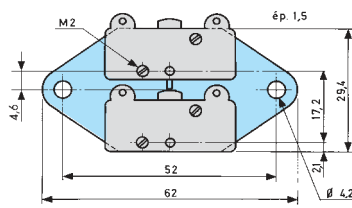

K2
2-pole vertical mounting plate

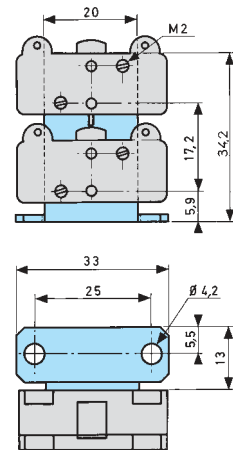

H
Horizontal single-pole mounting plate

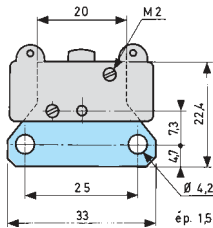

Unless indicated, the thickness of plates is 1.5 mm

Actuators and fixing positions

Actuators and fixing positions

Actuators		AR49	BR47	ER47	Q	V3 R15.5	E9
Operating force - max.	N	1.2	1.2	1.2	2.8	4	4
Release force - min.	N	0.25	0.25	0.2	0.45	0.8	1
Pre-travel - max.	mm	6.2	6.2	6.2	3.2	1.45	1.5
Differential travel	mm	2.1 ±0.9	2.1 ±0.9	2.1 ±0.9	1.05 ±0.4	0.5 ±0.2	0.5 ±0.2
Total travel max.	mm	7.5	8.4	7.5	4.5	1.9	1.9

Except where otherwise indicated, the flat and roller levers are mounted as shown in the dimensional drawings (mounted on the left).

Mounting accessories

Y Side plate



H Horizontal single-pole mounting plate



O2 2-pole side mounting plate



K2 2-pole vertical mounting plate



Other information

Mounting - Operation

See basic technical concepts