

Product Datasheet

JD496A-C

HPE Systems® Compatible 1.25Gb/s 80km SFP Transceiver

Hot Pluggable, Duplex LC, +3.3V, 1550nm, DFB-LD, SMF 80KM DDM 0~70C

FEATURES

- Up to 1.25Gb/s Data Links
- Hot-Pluggable
- Duplex LC connector
- Up to 80km on 9/125µm SMF
- 1550nm DFB laser transmitter
- Single +3.3V Power Supply
- Low power dissipation <1W typically
- Commercial operating temperature range 0°C to 70°C
- RoHS compliant and Lead Free

APPLICATIONS

- Metro/Access Networks
- 1.25 Gb/s 1000Base-ZX Ethernet
- 1×Fibre Channel
- Other Optical Links

DESCRIPTION

ATGBICS® Compatible JD496A is a high performance, cost effective module which have a duplex LC optics interface. Standard AC coupled CML for high speed signal and LVTTTL control and monitor signals. The receiver section uses a PIN receiver and the transmitter uses a 1550 nm DFB laser, up to 22dB link budge ensure this module 1000Base Ethernet 80km application.

Absolute Maximum Ratings

Parameter	Symbol	Min.	Typical	Max.	Unit
Storage Temperature	TS	-40		+85	°C
Supply Voltage	VCC	-0.5		4	V
Relative Humidity	RH	0		85	%

Product Datasheet

Recommended Operating Environment

Parameter		Symbol	Min.	Typical	Max.	Unit
Case operating Temperature	Commercial	TC	0		+70	°C
Supply Voltage		VCC	3.135		3.465	V
Supply Current		Icc			300	mA
Inrush Current		I _{surge}			I _{cc} +30	mA
Maximum Power		P _{max}			1	W

Electrical Characteristics (TOP = -40 to 85°C, VCC = 3.135 to 3.465 Volts)

Parameter	Symbol	Min.	Typical	Max.	Unit	Notes
Transmitter Section:						
Input differential impedance	R _{in}	90	100	110		
Single ended data input swing	V _{in PP}	250		1200	mVp-p	
Transmit Disable Voltage	VD	V _{cc} – 1.3		V _{cc}	V	2
Transmit Enable Voltage	VEN	V _{ee}		V _{ee} + 0.8	V	
Transmit Disable Assert Time	T _{dassert}			10	us	
Receiver Section:						
Single ended data output swing	V _{out,pp}	250		800	mv	3
LOS Fault	V _{losfault}	V _{cc} – 0.5		V _{CC_host}	V	5
LOS Normal	V _{los norm}	V _{ee}		V _{ee} +0.5	V	5
Power Supply Rejection	PSR	100			mVpp	6

Notes:

1. AC coupled.
2. Or open circuit.
3. Into 100 ohm differential termination.
4. 20 – 80 %
5. LOS is LVTTTL. Logic 0 indicates normal operation; logic 1 indicates no signal detected.
6. All transceiver specifications are compliant with a power supply sinusoidal modulation of 20 Hz to 1.5MHz up to specified value applied through the power supply filtering network shown on page 23 of the Small Form-factor Pluggable (SFP) Transceiver Multi-Source Agreement (MSA), September 14, 2000.
7. Optical Parameters (TOP = -40 to 85°C, VCC = 3.135 to 3.465 Volts)

Product Datasheet

Parameter	Symbol	Min.	Typical	Max.	Unit	Notes
Transmitter Section:						
Center Wavelength	λ_c	1530	1550	1570	nm	
Spectral Width	σ			1	nm	
Side Mode Suppression Ratio	SMSR	30			dB	
Optical Output Power	P _{out}	-2		+3	dBm	1
Extinction Ratio	ER	9			dB	
Optical Rise/Fall Time	tr / tf			260	ps	2
Relative Intensity Noise	RIN			-120	dB/Hz	
Output Eye Mask	Compliant with IEEE802.3 z (class 1 laser safety)					
Receiver Section:						
Optical Input Wavelength	λ_c	1270		1610	nm	
Receiver Overload	P _{ol}	-3			dBm	4
RX Sensitivity	Sen			-24	dBm	4
RX_LOS Assert	LOS A	-40			dBm	
RX_LOS De-assert	LOS D			-25	dBm	
RX_LOS Hysteresis	LOS H	0.5			dB	
General Specifications:						
Data Rate	BR		1.25		Gb/s	
Bit Error Rate	BER			10-12		
Max. Supported Link Length on 9/125 μ m SMF@1.25Gb/s	LMAX		80		km	
Total System Budget	LB	22			dB	

Notes:

1. The optical power is launched into SMF.
2. 20-80%.
3. Jitter measurements taken using Agilent OMNIBERT 718 in accordance with GR-253.
4. Measured with PRBS 27-1 at 10-12 BER

Product Datasheet

Pin Assignment

Diagram of Host Board Connector Block Pin Numbers and Name



Diagram of Host Board Connector Block Pin Numbers and Names

Product Datasheet

Pin Function Definitions

Pin	Name	Function	Plug Seq	Notes
1	VeeT	Transmitter Ground	1	1
2	TX Fault	Transmitter Fault Indication	3	
3	TX Disable	Transmitter Disable	3	2
4	MOD-DEF2	Module Definition	2	3
5	MOD-DEF1	Module Definition 1	3	3
6	MOD-DEF0	Module Definition 0	3	3
7	Rate Select	Not Connected	3	4
8	LOS	Loss of Signal	3	5
9	VeeR	Receiver Ground	1	1
10	VeeR	Receiver Ground	1	1
11	VeeR	Receiver Ground		1
12	RD-	Inv. Received Data Out	3	6
13	RD+	Received Data Out	3	6
14	VeeR	Receiver Ground	3	1
15	VccR	Receiver Power	2	1
16	VccT	Transmitter Power	2	
17	VeeT	Transmitter Ground	1	
18	TD+	Transmit Data In	3	6
19	TD-	Inv. Transmit In	3	6
20	VeeT	Transmitter Ground	1	

Notes:

1. Circuit ground is internally isolated from chassis ground.
2. Laser output disabled on TDIS >2.0V or open, enabled on TDIS <0.8V.
3. Should be pulled up with 4.7k - 10 kohms on host board to a voltage between 2.0V and 3.6V. MOD_DEF(0) pulls line low to indicate module is plugged in.
4. Rate select is not used
5. LOS is open collector output. Should be pulled up with 4.7k – 10 kohms on host board to a voltage between 2.0V and 3.6V. Logic 0 indicates normal operation; logic 1 indicates loss of signal.
6. AC Coupled

SFP Module EEPROM Information and Management

The SFP modules implement the 2-wire serial communication protocol as defined in the SFP -8472. The serial ID information of the SFP modules can be accessed through the I2C interface at address A0h.

Product Datasheet

EEPROM Serial ID Memory Contents (A0h)

Data Address	Length (Byte)	Name of Length	Description and Contents
Base ID Fields			
0	1	Identifier	Type of Serial transceiver (03h=SFP)
1	1	Reserved	Extended identifier of type serial transceiver (04h)
2	1	Connector	Code of optical connector type (07=LC)
3-10	8	Transceiver	
11	1	Encoding	NRZ(03h)
12	1	BR, Nominal	Nominal baud rate, unit of 100Mbps
13-14	2	Reserved	(0000h)
15	1	Length(9um)	Link length supported for 9/125um fiber, units of 100m
16	1	Length(50um)	Link length supported for 50/125um fiber, units of 10m
17	1	Length(62.5um)	Link length supported for 62.5/125um fiber, units of 10m
18	1	Length(Copper)	Link length supported for copper, units of meters
19	1	Reserved	
20-35	16	Vendor Name	SFP vendor name: ATGBICS
36	1	Reserved	
37-39	3	Vendor OUI	SFP transceiver vendor OUI ID
40-55	16	Vendor PN	Part Number: "JD496A-C" (ASCII)
56-59	4	Vendor rev	Revision level for part number
60-62	3	Reserved	
63	1	CCID	Least significant byte of sum of data in address 0-62
Extended ID Fields			
64-65	2	Option	Indicates which optical SFP signals are implemented (001Ah = LOS, TX_FAULT, TX_DISABLE all supported)
66	1	BR, max	Upper bit rate margin, units of %
67	1	BR, min	Lower bit rate margin, units of %
68-83	16	Vendor SN	Serial number (ASCII)
84-91	8	Date code	's Manufacturing date code
92-94	3	Reserved	
95	1	CCEX	Check code for the extended ID Fields (addresses 64 to 94)
Vendor Specific ID Fields			
96-127	32	Readable	specific date, read only
128-255	128	Reserved	Reserved for SFF-8079

Regulatory Compliance

Product Datasheet

The JD496A-C complies with international Electromagnetic Compatibility (EMC) and international safety requirements and standards (see details in Table following).

Electrostatic Discharge (ESD) to the Electrical Pins	MIL-STD-883E Method 3015.7	Class 1(>1000 V)
Electrostatic Discharge (ESD) to the Duplex LC Receptacle	IEC 61000-4-2 GR-1089-CORE	Compatible with standards
Electromagnetic Interference (EMI)	FCC Part 15 Class B EN55022 Class B (CISPR 22B) VCCI Class B	Compatible with standards
Laser Eye Safety	FDA 21CFR 1040.10 and 1040.11 EN60950, EN (IEC) 60825-1,2	Compatible with Class 1 laser product.

Recommended Circuit

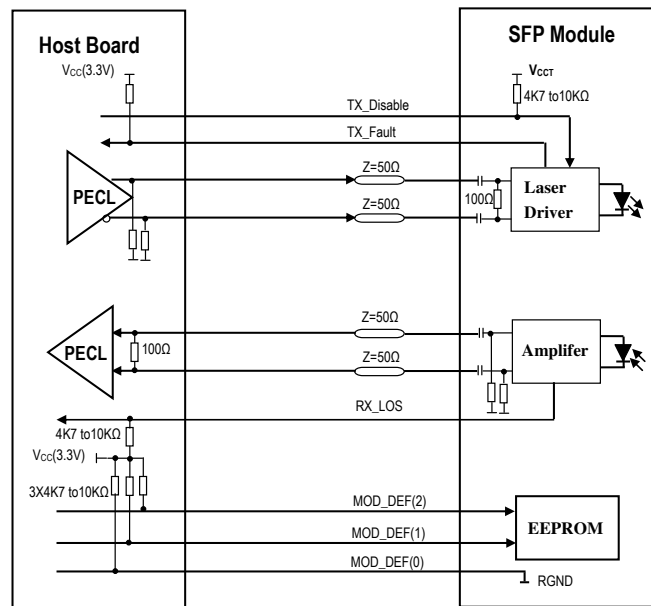

SFP Host Recommended Circuit

Product Datasheet

Mechanical Dimensions



Mechanical Drawing