

SAC-4P-M12MS/0,6-800/M12FR-3L

Order No.: 1567173



<http://eshop.phoenixcontact.de/phoenix/treeViewClick.do?UID=1567173>

Sensor/Actuator cable, 4-position, PUR halogen-free, welding sputter-resistant, highly flexible, Gray RAL 7001, Plug, straight M12, A-coded, on Socket, angled M12, A-coded, Cable length: 0.6 m

Commercial data	
GTIN (EAN)	4  046356 326360
Note	Made-to-order
sales group	D111
Pack	1 pcs.
Customs tariff	85444290

Product notes

WEEE/RoHS-compliant since:
10/30/2007



<http://www.download.phoenixcontact.com>
Please note that the data given here has been taken from the online catalog. For comprehensive information and data, please refer to the user documentation. The General Terms and Conditions of Use apply to Internet downloads.

Technical data	
General data	
Rated current at 40°C	4 A
Rated voltage	24 V
Number of positions	4
Volume resistance	≤ 5 mΩ

Insulation resistance	≥ 100 MΩ
Length of cable	0.6 m
Ambient temperature (operation)	-25 °C ... 90 °C (Male connector / female connector)

General characteristics

Standards/regulations	M12 connector IEC 61076-2-101
Coding	A - standard
Surge voltage category	II
Pollution degree	3
Degree of protection	IP65/IP68/IP69K
Insertion/withdrawal cycles	≥ 100
Contact material	CuSn
Contact surface material	Ni/Au
Contact carrier material	TPU GF
Material of grip body	TPU, hardly inflammable, self-extinguishing
Material, knurls	Zinc die-cast, (nickel-plated)
Sealing material	NBR
Status display	3 LEDs

Conductor data

Cable type	PUR halogen-free, highly flexible, resistant to welding beads, gray
Cable type (abbreviation)	800
Cable abbreviation	Li12YYTPE-HF
Conductor cross section	0.34 mm ²
AWG signal line	22
Conductor structure signal line	42x 0.10 mm
Core diameter including insulation	1.3 mm ±0.05 mm
External cable diameter	4.8 mm ±0.2 mm
Wire colors	Black, brown, blue, white
External sheath, color	Gray RAL 7001
Insulation resistance	≥ 20 MΩ*km
Conductor resistance	Approx. 53 Ω/km
Nominal voltage, conductor	300 V
Test voltage, conductor	2000 V
Overall twist	4 wires, twisted
Outer sheath, material	PUR

Material conductor insulation	PES
Conductor material	Bare Cu litz wires
Smallest bending radius, fixed installation	24 mm
Smallest bending radius, movable installation	50 mm
Number of bending cycles	15000000
Bending radius	50 mm
Traversing path	0.9 m
Traversing rate	5 m/s
Acceleration	30 m/s ²
Torsion force	± 360 °/m
Ambient temperature (operation)	-40 °C ... 90 °C (cable, fixed installation) -30 °C ... 90 °C (cable, flexible installation)
Special properties	Sheath resistant to welding beads, can be recycled, matt, without adhesion, wear-resistant, flame resistant and self-extinguishing Free from silicone and cadmium Free of substances which would hinder coating with paint or varnish
Flame resistance	DIN VDE 0472 part 804, test type B IEC 60332-1 in accordance with FT1 as per UL 758
Halogen-free	The cable is halogen-free
Resistance to oil	Excellent oil-resistance (as per DIN VDE 0250 T.407)
Other resistance	Highly resistant to acids, alkaline solutions and solvents

Certificates / Approvals



Certification

CUL Listed, UL Listed

Diagrams/Drawings

Dimensioned drawing

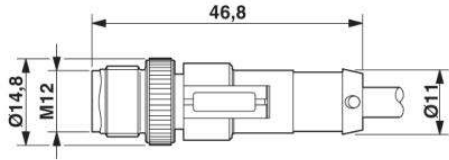

M12 x 1 male connector, straight

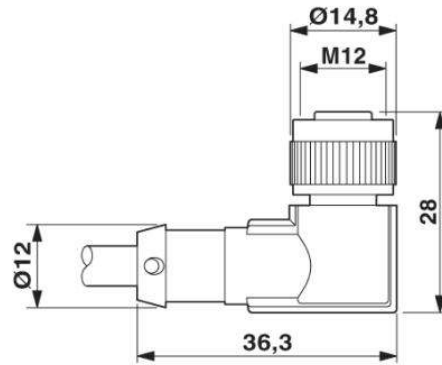

Socket M12 x 1, angled, with LED

Circuit diagram

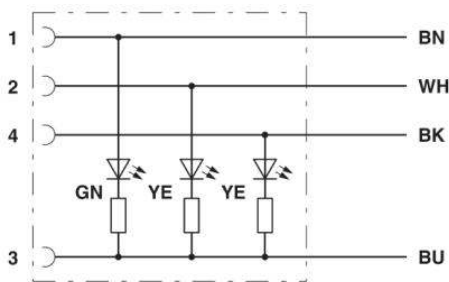

Contact assignment of the M12 plug and the M12 socket

Schematic diagram

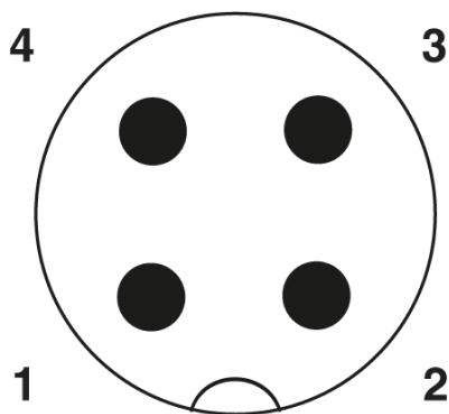

Pin assignment M12 plug, 4-pos., A-coded, view plug side

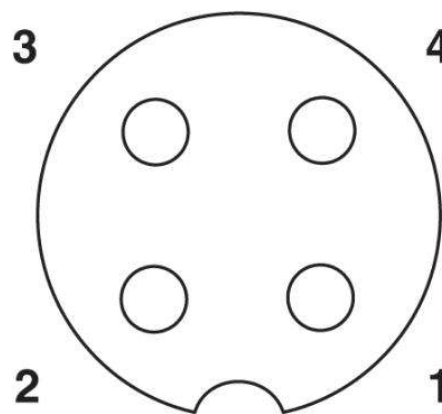

Pin assignment M12 socket, 4-pos., A-coded, view female side

Address

PHOENIX CONTACT Inc., USA
586 Fulling Mill Road
Middletown, PA 17057, USA
Phone (800) 888-7388
Fax (717) 944-1625
<http://www.phoenixcon.com>



© 2011 Phoenix Contact
Technical modifications reserved;