

CSD18511KCS 40-V N-Channel NexFET™ Power MOSFET

1 Features

- Low Q_g and Q_{gd}
- Low $R_{DS(on)}$
- Low-Thermal Resistance
- Avalanche Rated
- Lead-Free Terminal Plating
- RoHS Compliant
- Halogen Free
- TO-220 Plastic Package

2 Applications

- Secondary Side Synchronous Rectifier
- Motor Control

3 Description

This 40-V, 2.1-m Ω , TO-220 NexFET™ power MOSFET is designed to minimize losses in power conversion applications.

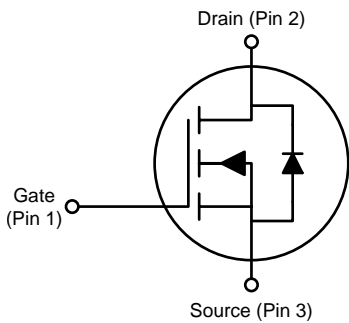

Product Summary

$T_A = 25^\circ\text{C}$		TYPICAL VALUE		UNIT
V_{DS}	Drain-to-Source Voltage	40		V
Q_g	Gate Charge Total (10 V)	63.9		nC
Q_{gd}	Gate Charge Gate-to-Drain	9.7		nC
$R_{DS(on)}$	Drain-to-Source On-Resistance	$V_{GS} = 4.5\text{ V}$	3.2	m Ω
		$V_{GS} = 10\text{ V}$	2.1	
$V_{GS(th)}$	Threshold Voltage	1.8		V

Device Information⁽¹⁾

DEVICE	MEDIA	QTY	PACKAGE	SHIP
CSD18511KCS	Tube	50	TO-220 Plastic Package	Tube

(1) For all available packages, see the orderable addendum at the end of the data sheet.

Absolute Maximum Ratings

$T_A = 25^\circ\text{C}$		VALUE	UNIT
V_{DS}	Drain-to-Source Voltage	40	V
V_{GS}	Gate-to-Source Voltage	± 20	V
I_D	Continuous Drain Current (Package Limited)	110	A
	Continuous Drain Current (Silicon Limited), $T_C = 25^\circ\text{C}$	194	
	Continuous Drain Current (Silicon Limited), $T_C = 100^\circ\text{C}$	137	
I_{DM}	Pulsed Drain Current ⁽¹⁾	400	A
P_D	Power Dissipation	188	W
T_J, T_{stg}	Operating Junction, Storage Temperature	-55 to 175	$^\circ\text{C}$
E_{AS}	Avalanche Energy, Single Pulse $I_D = 56\text{ A}, L = 0.1\text{ mH}, R_G = 25\ \Omega$	156	mJ

(1) Max $R_{\theta JC} = 0.8^\circ\text{C/W}$, pulse duration $\leq 100\ \mu\text{s}$, duty cycle $\leq 1\%$.

$R_{DS(on)}$ vs V_{GS}

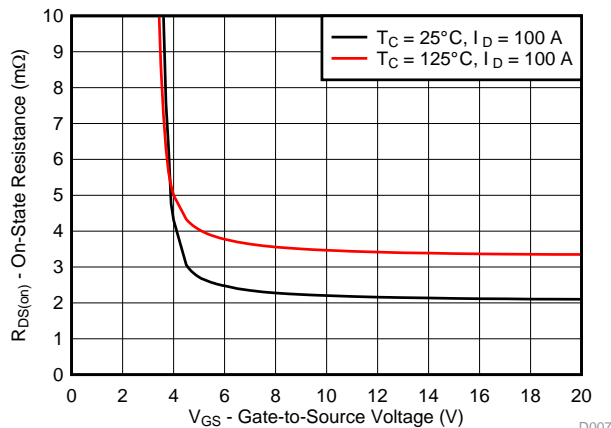

D007

Gate Charge

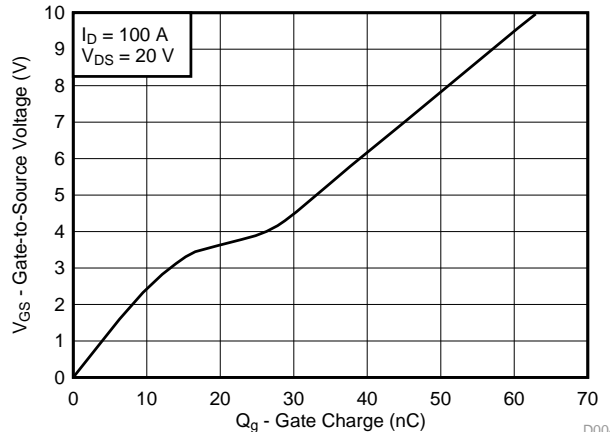

D004



Table of Contents

1 Features	1	6 Device and Documentation Support	7
2 Applications	1	6.1 Receiving Notification of Documentation Updates...	7
3 Description	1	6.2 Community Resources.....	7
4 Revision History	2	6.3 Trademarks	7
5 Specifications	3	6.4 Electrostatic Discharge Caution.....	7
5.1 Electrical Characteristics.....	3	6.5 Glossary	7
5.2 Thermal Information	3	7 Mechanical, Packaging, and Orderable Information	8
5.3 Typical MOSFET Characteristics.....	4	7.1 KCS Package Dimensions.....	8

4 Revision History

DATE	REVISION	NOTES
July 2017	*	Initial release.

5 Specifications

5.1 Electrical Characteristics

 $T_A = 25^\circ\text{C}$ (unless otherwise stated)

PARAMETER		TEST CONDITIONS	MIN	TYP	MAX	UNIT
STATIC CHARACTERISTICS						
V_{DSS}	Drain-to-source voltage	$V_{GS} = 0\text{ V}, I_D = 250\ \mu\text{A}$	40			V
I_{DSS}	Drain-to-source leakage current	$V_{GS} = 0\text{ V}, V_{DS} = 32\text{ V}$			1	μA
I_{GSS}	Gate-to-source leakage current	$V_{DS} = 0\text{ V}, V_{GS} = 20\text{ V}$			100	nA
$V_{GS(th)}$	Gate-to-source threshold voltage	$V_{DS} = V_{GS}, I_D = 250\ \mu\text{A}$	1.5	1.8	2.4	V
$R_{DS(on)}$	Drain-to-source on-resistance	$V_{GS} = 4.5\text{ V}, I_D = 100\text{ A}$		3.2	4.2	m Ω
		$V_{GS} = 10\text{ V}, I_D = 100\text{ A}$		2.1	2.6	
g_{fs}	Transconductance	$V_{DS} = 4\text{ V}, I_D = 100\text{ A}$		249		S
DYNAMIC CHARACTERISTICS						
C_{iss}	Input capacitance	$V_{GS} = 0\text{ V}, V_{DS} = 20\text{ V}, f = 1\text{ MHz}$		4570	5940	pF
C_{oss}	Output capacitance			454	591	pF
C_{rss}	Reverse transfer capacitance			235	306	pF
R_G	Series gate resistance			0.9	1.8	Ω
Q_g	Gate charge total (4.5 V)	$V_{DS} = 20\text{ V}, I_D = 100\text{ A}$		31		nC
Q_g	Gate charge total (10 V)			64		nC
Q_{gd}	Gate charge gate-to-drain			9.7		nC
Q_{gs}	Gate charge gate-to-source			17.9		nC
$Q_{g(th)}$	Gate charge at V_{th}			7.4		nC
Q_{oss}	Output charge		$V_{DS} = 20\text{ V}, V_{GS} = 0\text{ V}$		20.7	
$t_{d(on)}$	Turnon delay time	$V_{DS} = 20\text{ V}, V_{GS} = 10\text{ V}, I_{DS} = 100\text{ A}, R_G = 0\ \Omega$		8		ns
t_r	Rise time			6		ns
$t_{d(off)}$	Turnoff delay time			17		ns
t_f	Fall time			3		ns
DIODE CHARACTERISTICS						
V_{SD}	Diode forward voltage	$I_{SD} = 100\text{ A}, V_{GS} = 0\text{ V}$		0.9	1.0	V
Q_{rr}	Reverse recovery charge	$V_{DS} = 20\text{ V}, I_F = 100\text{ A}, di/dt = 300\text{ A}/\mu\text{s}$		62		nC
t_{rr}	Reverse recovery time			31		ns

5.2 Thermal Information

 $T_A = 25^\circ\text{C}$ (unless otherwise stated)

THERMAL METRIC		MIN	TYP	MAX	UNIT
$R_{\theta JC}$	Junction-to-case thermal resistance			0.8	$^\circ\text{C}/\text{W}$
$R_{\theta JA}$	Junction-to-ambient thermal resistance			62	$^\circ\text{C}/\text{W}$

5.3 Typical MOSFET Characteristics

T_A = 25°C (unless otherwise stated)

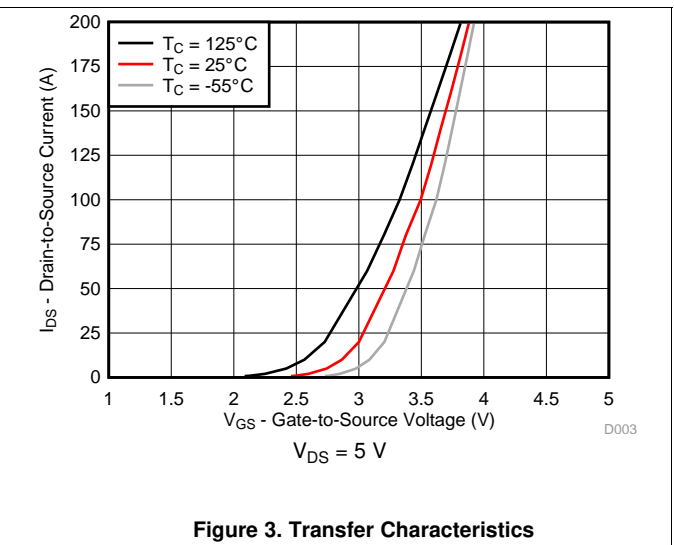
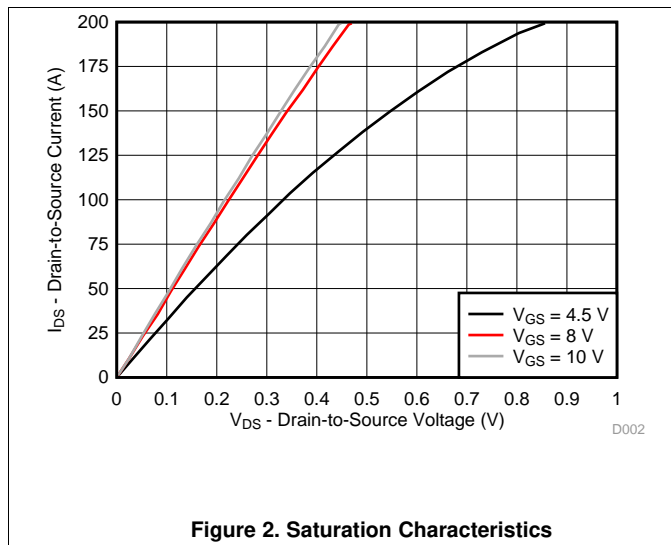
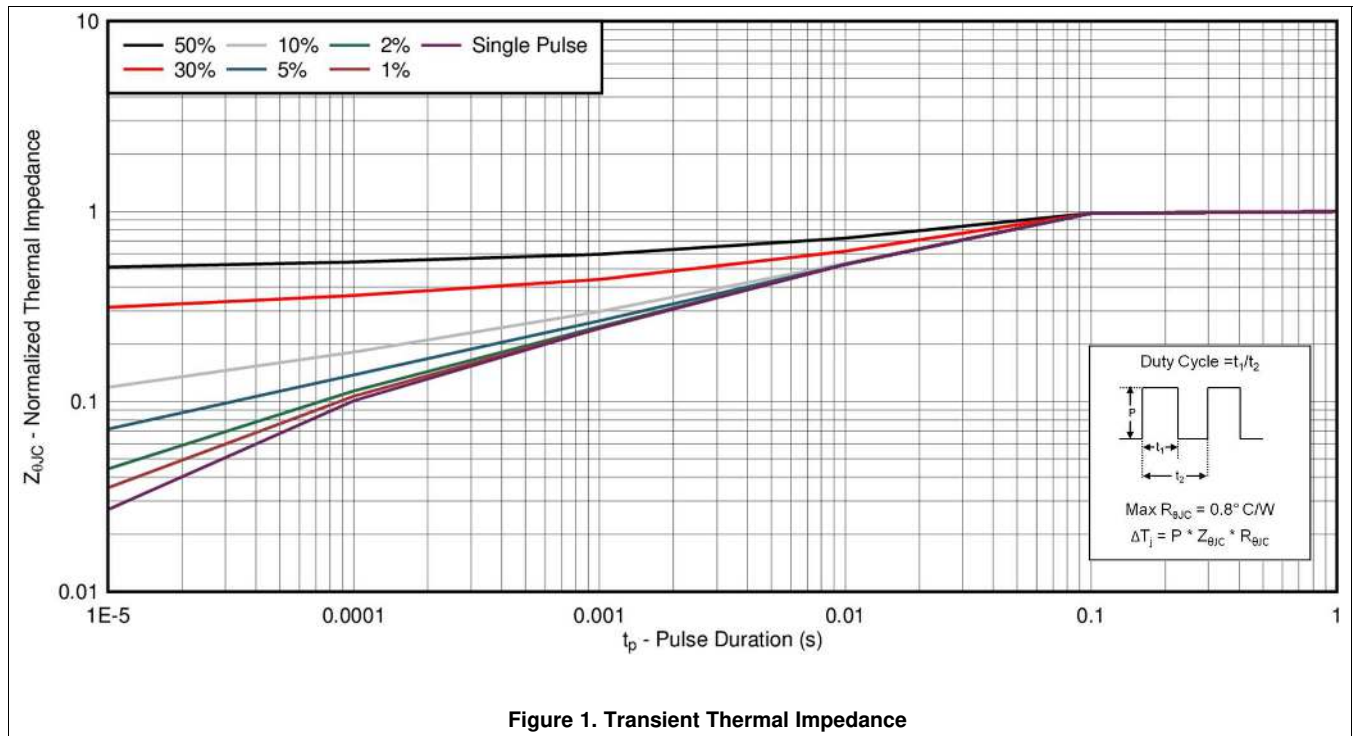

Typical MOSFET Characteristics (continued)

T_A = 25°C (unless otherwise stated)

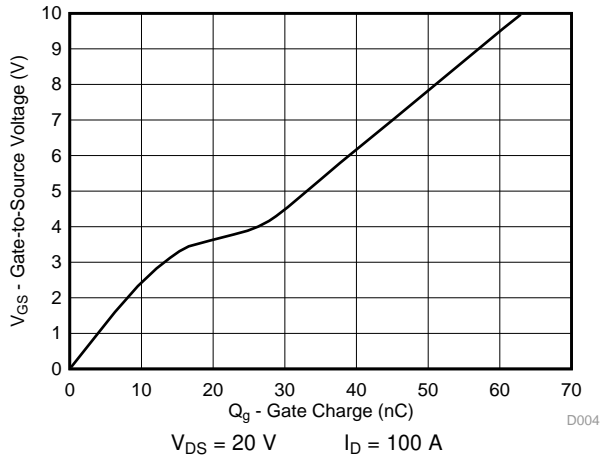

Figure 4. Gate Charge

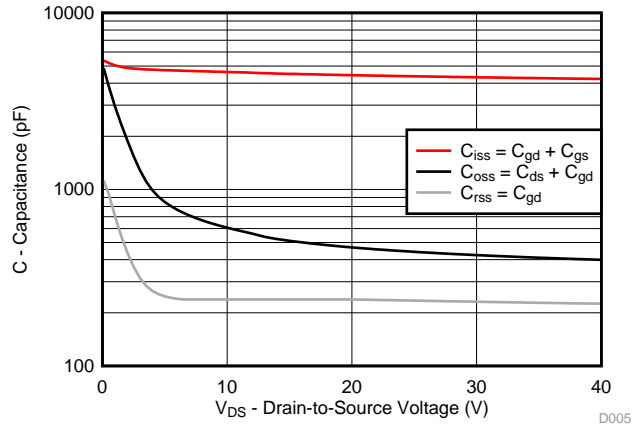

Figure 5. Capacitance

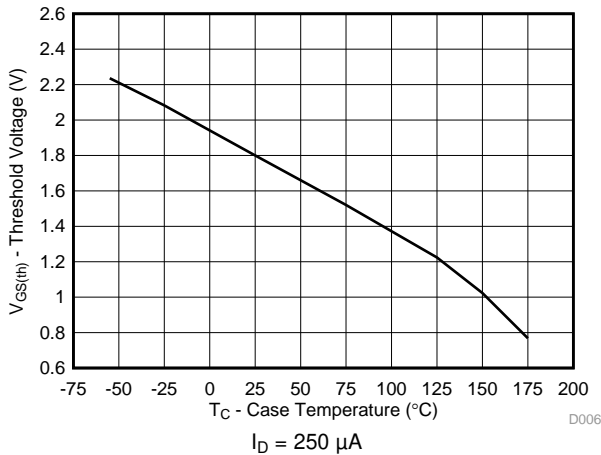

Figure 6. Threshold Voltage vs Temperature

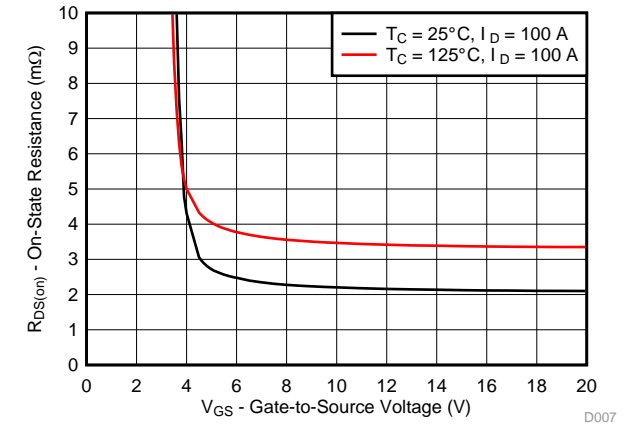

Figure 7. On-State Resistance vs Gate-to-Source Voltage

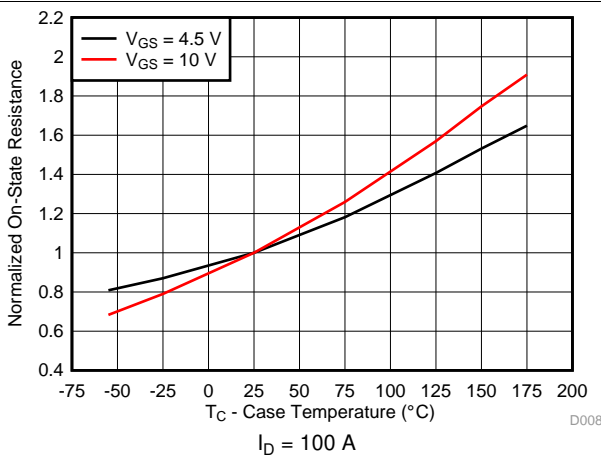

Figure 8. Normalized On-State Resistance vs Temperature

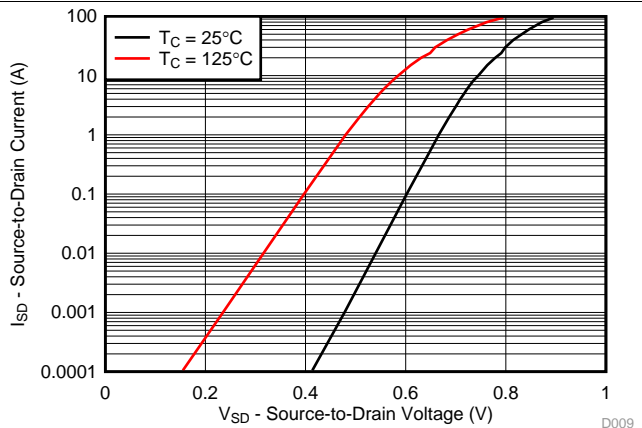
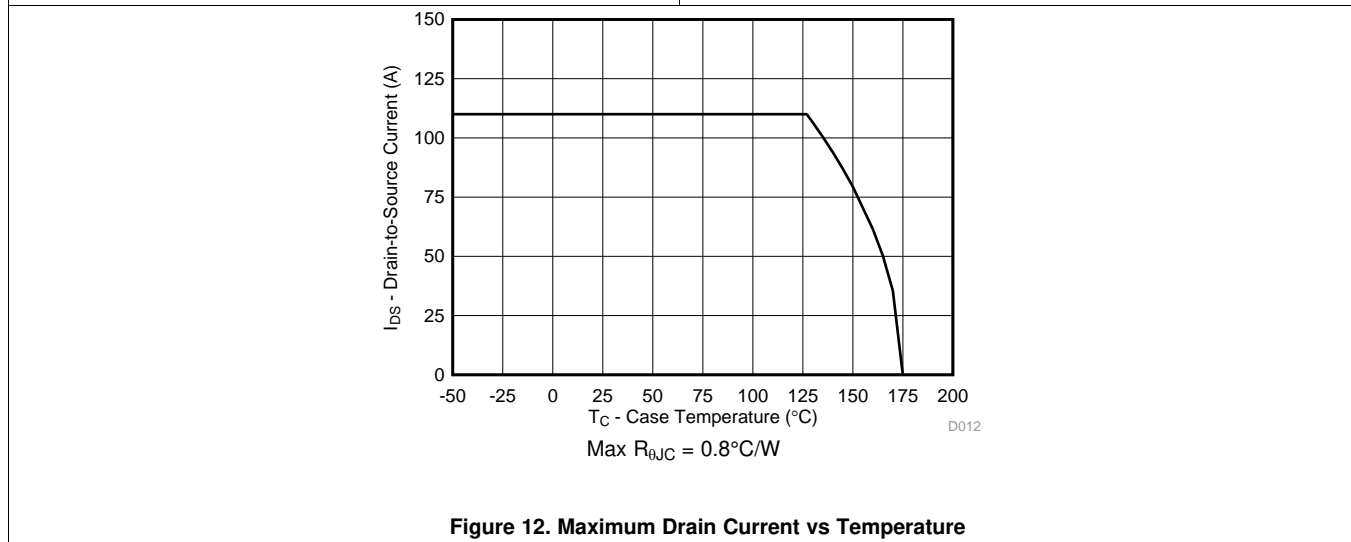
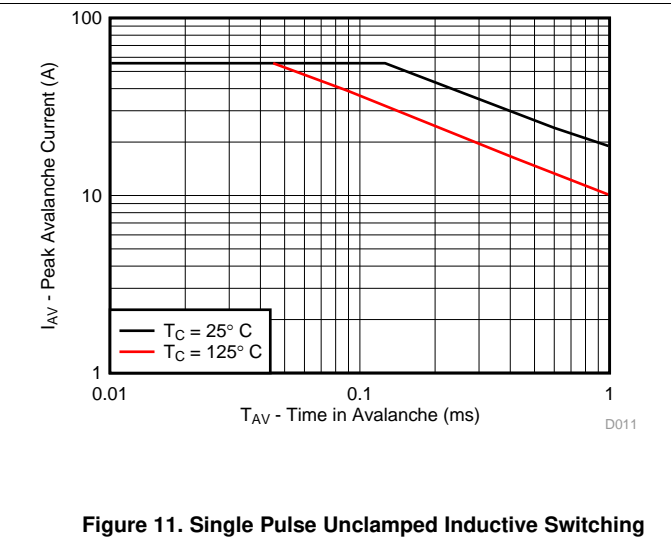
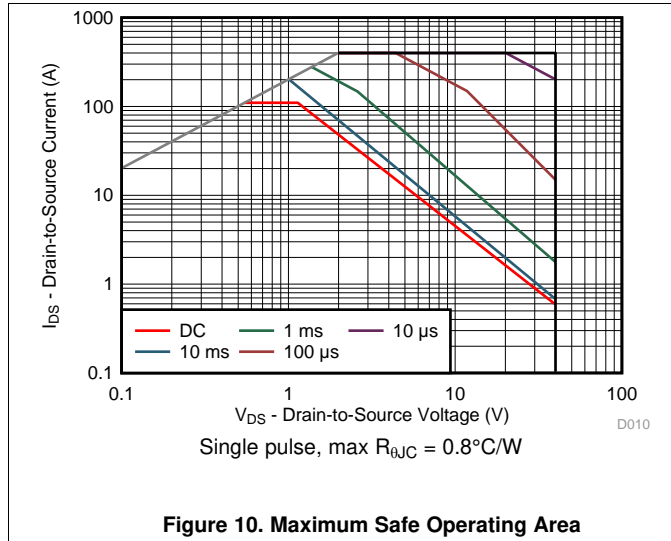

Figure 9. Typical Diode Forward Voltage

Typical MOSFET Characteristics (continued)

$T_A = 25^\circ\text{C}$ (unless otherwise stated)



6 Device and Documentation Support

6.1 Receiving Notification of Documentation Updates

To receive notification of documentation updates, navigate to the device product folder on ti.com. In the upper right corner, click on *Alert me* to register and receive a weekly digest of any product information that has changed. For change details, review the revision history included in any revised document.

6.2 Community Resources

The following links connect to TI community resources. Linked contents are provided "AS IS" by the respective contributors. They do not constitute TI specifications and do not necessarily reflect TI's views; see TI's [Terms of Use](#).

TI E2E™ Online Community *TI's Engineer-to-Engineer (E2E) Community*. Created to foster collaboration among engineers. At e2e.ti.com, you can ask questions, share knowledge, explore ideas and help solve problems with fellow engineers.

Design Support *TI's Design Support* Quickly find helpful E2E forums along with design support tools and contact information for technical support.

6.3 Trademarks

NexFET, E2E are trademarks of Texas Instruments.
All other trademarks are the property of their respective owners.

6.4 Electrostatic Discharge Caution



These devices have limited built-in ESD protection. The leads should be shorted together or the device placed in conductive foam during storage or handling to prevent electrostatic damage to the MOS gates.

6.5 Glossary

[SLYZ022](#) — *TI Glossary*.

This glossary lists and explains terms, acronyms, and definitions.

7 Mechanical, Packaging, and Orderable Information

The following pages include mechanical, packaging, and orderable information. This information is the most current data available for the designated devices. This data is subject to change without notice and revision of this document. For browser-based versions of this data sheet, refer to the left-hand navigation.

7.1 KCS Package Dimensions

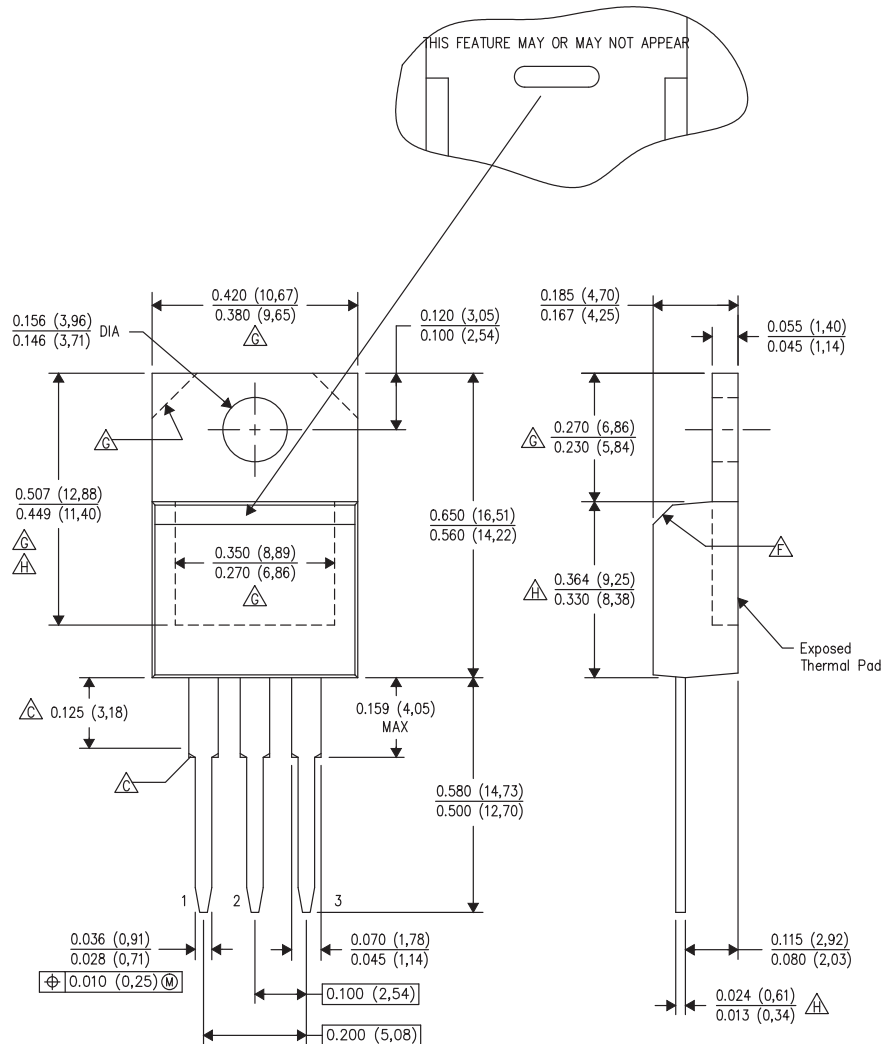





- NOTES:
- A. All linear dimensions are in inches (millimeters).
 - B. This drawing is subject to change without notice.
 -  Lead dimensions are not controlled within this area. Chamfer may or may not appear.
 - D. All lead dimensions apply before solder dip.
 - E. The center lead is in electrical contact with the mounting tab.
 -  The chamfer is optional.
 -  Thermal pad contour optional within these dimensions.
 -  Falls within JEDEC TO-220 variation AB, except minimum lead thickness, minimum exposed pad length, and maximum body length.

Table 1. Pin Configuration

POSITION	DESIGNATION
Pin 1	Gate
Pin 2 / Tab	Drain
Pin 3	Source

IMPORTANT NOTICE

Texas Instruments Incorporated (TI) reserves the right to make corrections, enhancements, improvements and other changes to its semiconductor products and services per JESD46, latest issue, and to discontinue any product or service per JESD48, latest issue. Buyers should obtain the latest relevant information before placing orders and should verify that such information is current and complete.

TI's published terms of sale for semiconductor products (<http://www.ti.com/sc/docs/stdterms.htm>) apply to the sale of packaged integrated circuit products that TI has qualified and released to market. Additional terms may apply to the use or sale of other types of TI products and services.

Reproduction of significant portions of TI information in TI data sheets is permissible only if reproduction is without alteration and is accompanied by all associated warranties, conditions, limitations, and notices. TI is not responsible or liable for such reproduced documentation. Information of third parties may be subject to additional restrictions. Resale of TI products or services with statements different from or beyond the parameters stated by TI for that product or service voids all express and any implied warranties for the associated TI product or service and is an unfair and deceptive business practice. TI is not responsible or liable for any such statements.

Buyers and others who are developing systems that incorporate TI products (collectively, "Designers") understand and agree that Designers remain responsible for using their independent analysis, evaluation and judgment in designing their applications and that Designers have full and exclusive responsibility to assure the safety of Designers' applications and compliance of their applications (and of all TI products used in or for Designers' applications) with all applicable regulations, laws and other applicable requirements. Designer represents that, with respect to their applications, Designer has all the necessary expertise to create and implement safeguards that (1) anticipate dangerous consequences of failures, (2) monitor failures and their consequences, and (3) lessen the likelihood of failures that might cause harm and take appropriate actions. Designer agrees that prior to using or distributing any applications that include TI products, Designer will thoroughly test such applications and the functionality of such TI products as used in such applications.

TI's provision of technical, application or other design advice, quality characterization, reliability data or other services or information, including, but not limited to, reference designs and materials relating to evaluation modules, (collectively, "TI Resources") are intended to assist designers who are developing applications that incorporate TI products; by downloading, accessing or using TI Resources in any way, Designer (individually or, if Designer is acting on behalf of a company, Designer's company) agrees to use any particular TI Resource solely for this purpose and subject to the terms of this Notice.

TI's provision of TI Resources does not expand or otherwise alter TI's applicable published warranties or warranty disclaimers for TI products, and no additional obligations or liabilities arise from TI providing such TI Resources. TI reserves the right to make corrections, enhancements, improvements and other changes to its TI Resources. TI has not conducted any testing other than that specifically described in the published documentation for a particular TI Resource.

Designer is authorized to use, copy and modify any individual TI Resource only in connection with the development of applications that include the TI product(s) identified in such TI Resource. NO OTHER LICENSE, EXPRESS OR IMPLIED, BY ESTOPPEL OR OTHERWISE TO ANY OTHER TI INTELLECTUAL PROPERTY RIGHT, AND NO LICENSE TO ANY TECHNOLOGY OR INTELLECTUAL PROPERTY RIGHT OF TI OR ANY THIRD PARTY IS GRANTED HEREIN, including but not limited to any patent right, copyright, mask work right, or other intellectual property right relating to any combination, machine, or process in which TI products or services are used. Information regarding or referencing third-party products or services does not constitute a license to use such products or services, or a warranty or endorsement thereof. Use of TI Resources may require a license from a third party under the patents or other intellectual property of the third party, or a license from TI under the patents or other intellectual property of TI.

TI RESOURCES ARE PROVIDED "AS IS" AND WITH ALL FAULTS. TI DISCLAIMS ALL OTHER WARRANTIES OR REPRESENTATIONS, EXPRESS OR IMPLIED, REGARDING RESOURCES OR USE THEREOF, INCLUDING BUT NOT LIMITED TO ACCURACY OR COMPLETENESS, TITLE, ANY EPIDEMIC FAILURE WARRANTY AND ANY IMPLIED WARRANTIES OF MERCHANTABILITY, FITNESS FOR A PARTICULAR PURPOSE, AND NON-INFRINGEMENT OF ANY THIRD PARTY INTELLECTUAL PROPERTY RIGHTS. TI SHALL NOT BE LIABLE FOR AND SHALL NOT DEFEND OR INDEMNIFY DESIGNER AGAINST ANY CLAIM, INCLUDING BUT NOT LIMITED TO ANY INFRINGEMENT CLAIM THAT RELATES TO OR IS BASED ON ANY COMBINATION OF PRODUCTS EVEN IF DESCRIBED IN TI RESOURCES OR OTHERWISE. IN NO EVENT SHALL TI BE LIABLE FOR ANY ACTUAL, DIRECT, SPECIAL, COLLATERAL, INDIRECT, PUNITIVE, INCIDENTAL, CONSEQUENTIAL OR EXEMPLARY DAMAGES IN CONNECTION WITH OR ARISING OUT OF TI RESOURCES OR USE THEREOF, AND REGARDLESS OF WHETHER TI HAS BEEN ADVISED OF THE POSSIBILITY OF SUCH DAMAGES.

Unless TI has explicitly designated an individual product as meeting the requirements of a particular industry standard (e.g., ISO/TS 16949 and ISO 26262), TI is not responsible for any failure to meet such industry standard requirements.

Where TI specifically promotes products as facilitating functional safety or as compliant with industry functional safety standards, such products are intended to help enable customers to design and create their own applications that meet applicable functional safety standards and requirements. Using products in an application does not by itself establish any safety features in the application. Designers must ensure compliance with safety-related requirements and standards applicable to their applications. Designer may not use any TI products in life-critical medical equipment unless authorized officers of the parties have executed a special contract specifically governing such use. Life-critical medical equipment is medical equipment where failure of such equipment would cause serious bodily injury or death (e.g., life support, pacemakers, defibrillators, heart pumps, neurostimulators, and implantables). Such equipment includes, without limitation, all medical devices identified by the U.S. Food and Drug Administration as Class III devices and equivalent classifications outside the U.S.

TI may expressly designate certain products as completing a particular qualification (e.g., Q100, Military Grade, or Enhanced Product). Designers agree that it has the necessary expertise to select the product with the appropriate qualification designation for their applications and that proper product selection is at Designers' own risk. Designers are solely responsible for compliance with all legal and regulatory requirements in connection with such selection.

Designer will fully indemnify TI and its representatives against any damages, costs, losses, and/or liabilities arising out of Designer's non-compliance with the terms and provisions of this Notice.