

THIS DRAWING IS UNPUBLISHED. RELEASED FOR PUBLICATION 2011
 © COPYRIGHT 2011 ALL RIGHTS RESERVED.

LOC	DIST	REVISIONS			
P	LTR	DESCRIPTION	DATE	DWN	APVD
AL	2	G1	ECR 12-004643	17APR2012	XP RS

ALABEO MAX. PERMITIDO HASTA 9.2
 PERMISSIBLE WARP TO 9.2

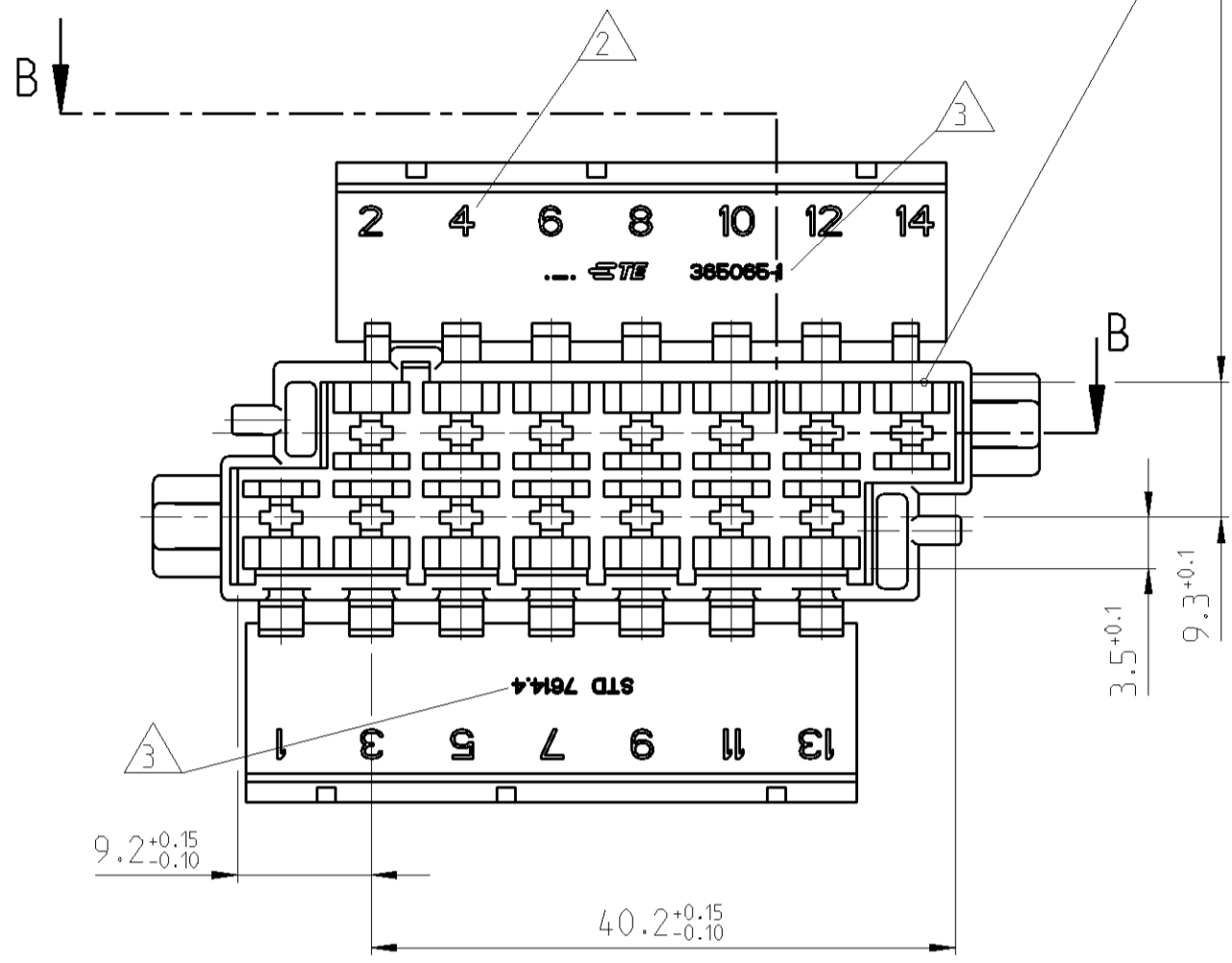

SECCION A-A SECTION

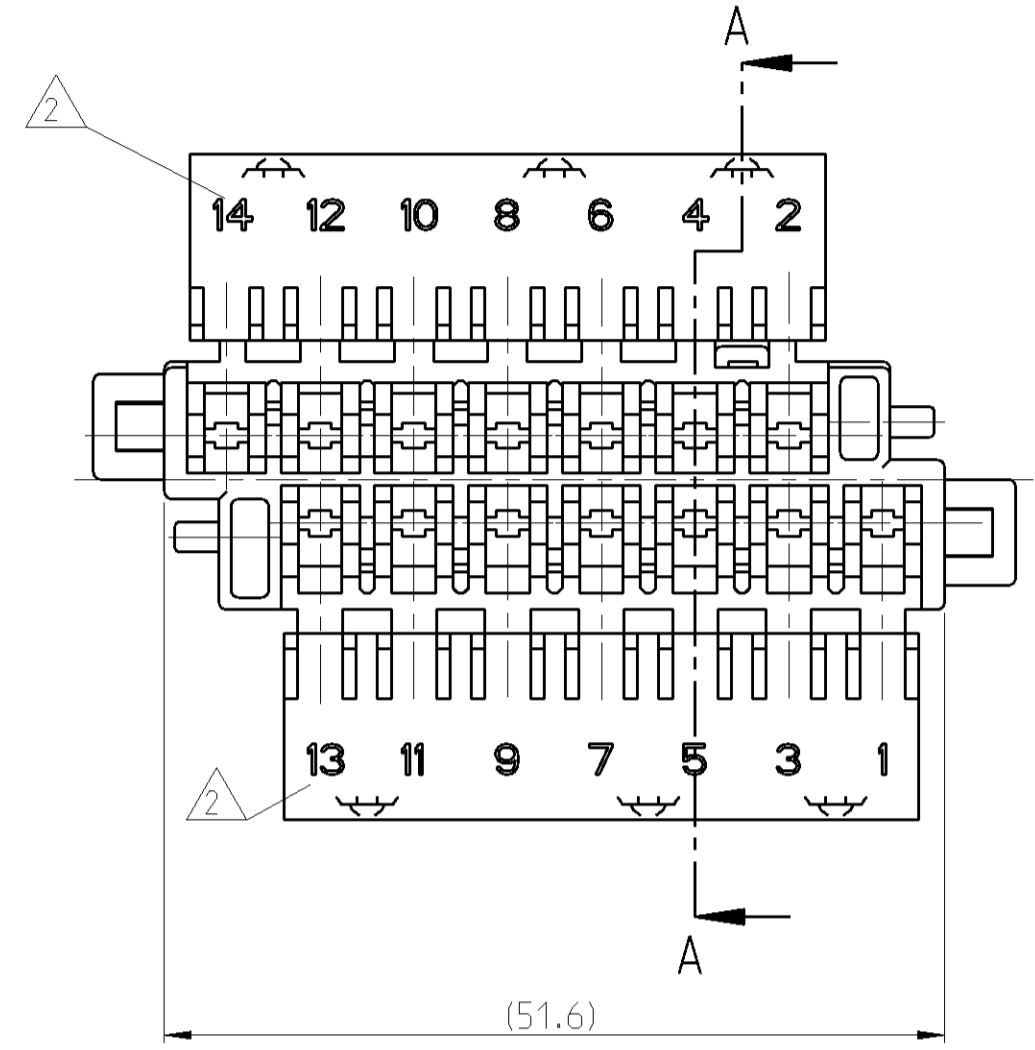
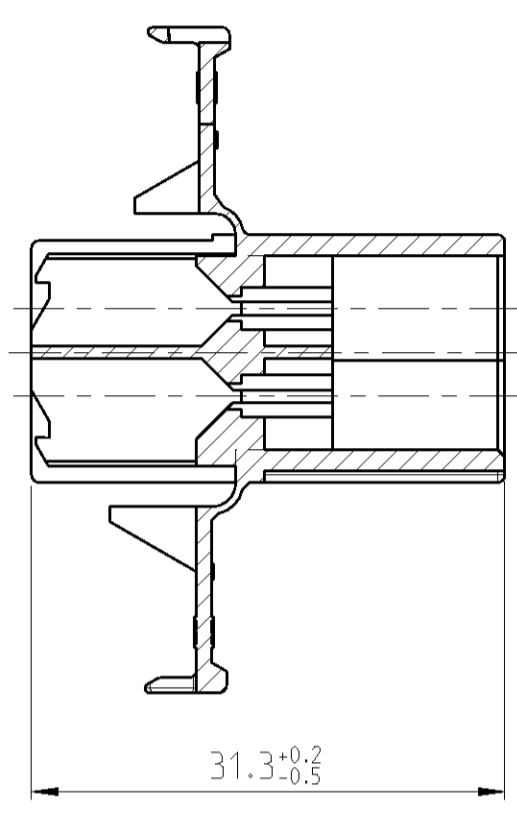

SECCION B-B SECTION

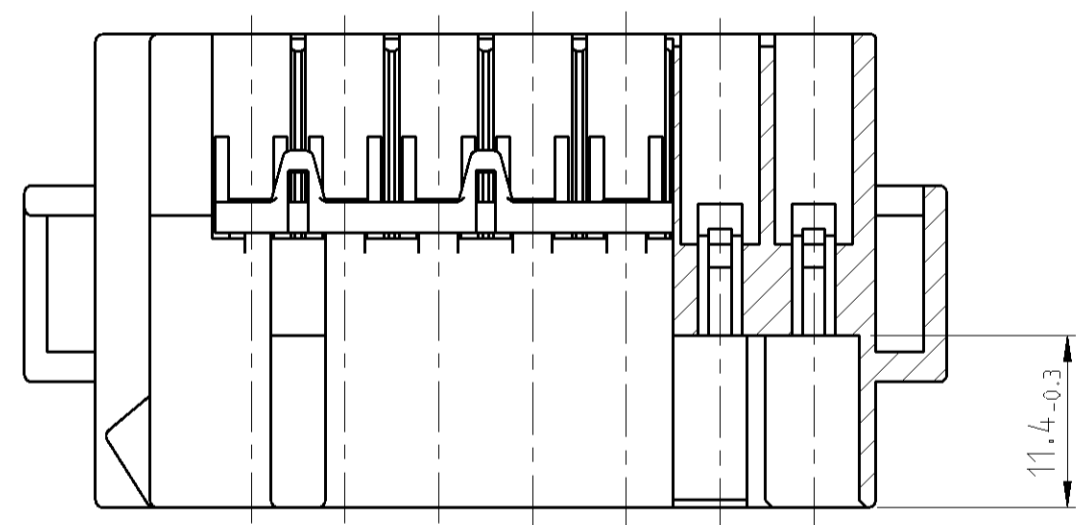

DETALLE CAJA CON BISAGRA CERRADA
 HOUSING WITH CLOSED FLAP

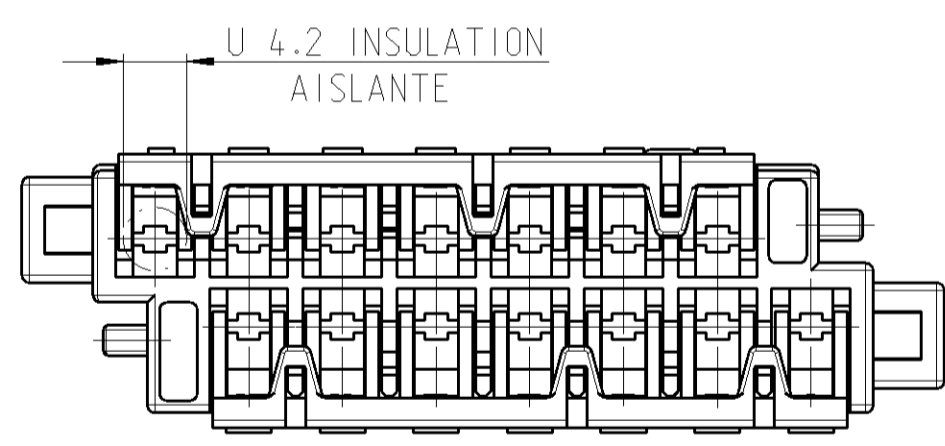

- MATERIAL Y COLORES HAN DE ESTAR LIBRES DE CADMIO
 MATERIAL AND COLORS ARE FREE OF CADMIUM
- ALTURA LETRA 2
 CHARACTER HEIGHT 2
- ALTURA LETRA 1
 CHARACTER HEIGHT 1
- USAR CON 365066
 FITTING WITH 365066
- LAS PIEZAS DEBEN IR EMPAQUETADAS HERMETICAMENTE
 Y SU CONTENIDO DE HUMEDAD DEBE SER 2.5±1%
 PARTS MUST BE AIR TIGHT PACKAGED,
 MOISTURE CONTENT MUST BE 2.5±1%

CODIGO 1
 CODING
 ESCALA
 SCALE 1:1

CODIGO 2
 CODING
 ESCALA
 SCALE 1:1

CODIGO 3
 CODING
 ESCALA
 SCALE 1:1

CODIGO 4
 CODING
 ESCALA
 SCALE 1:1

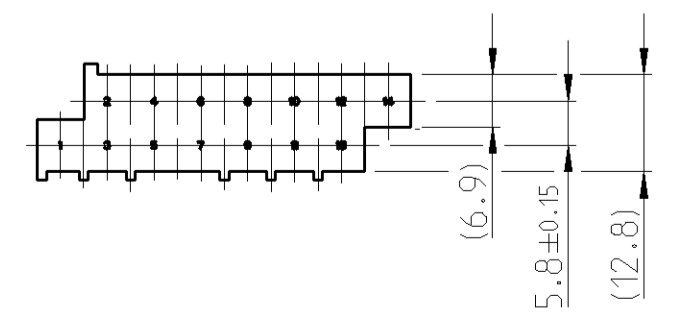
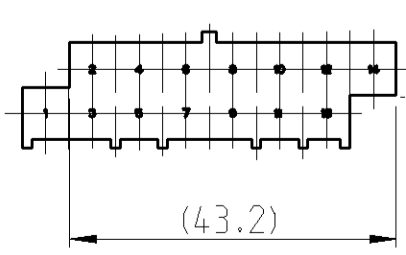
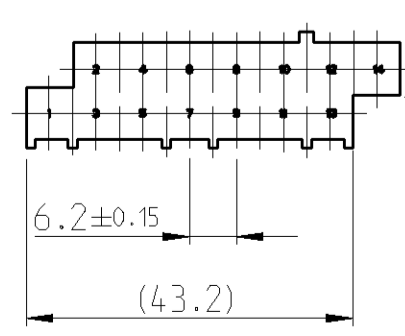
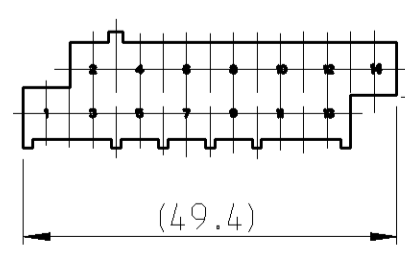

Code No.	Part Number	Material	Finish / Colour
CODE 4	365065-4	PA 6.6	YELLOW
CODE 3	365065-3	PA 6.6	BLACK
CODE 2	365065-2	PA 6.6	GREY
CODE 1	365065-1	PA 6.6	NATUR

THIS DRAWING IS A CONTROLLED DOCUMENT.		DWN R. ULLRICH 16NOV1984	TE Connectivity	
DIMENSIONS: mm		CHK J. PASCUAL 15JUN1993		
TOLERANCES UNLESS OTHERWISE SPECIFIED:		APVD L. BATILO 15JUN1993	NAME 14 POS. TAB-HOUSING	
0 PLC ±±		PRODUCT SPEC -	SIZE CAGE CODE DRAWING NO RESTRICTED TO	
1 PLC ±± ±0.2		APPLICATION SPEC -	A2 00779 C-365065	
2 PLC ±± ±0.2		WEIGHT -	SCALE 2:1 SHEET 1 OF 1 REV G1	
3 PLC ±± ±0.2		CUSTOMER DRAWING		
4 PLC ±± ±0.2				
ANGLES FINISH				
SEE PART LIST				