

IRDC3622S

USER GUIDE FOR CURRENT SHARING IRDC3622S EVALUATION BOARD USING IRF6622 AND IRF6678 DIRECTFET MOSFETS

Table of Contents

	Page
Description	2
Board Features	2
Connections & Operating Instructions	3
Layout	5
Schematic	10
Bill of Materials	11
Waveforms	12
MLPQ Package	20

USER GUIDE FOR CURRENT SHARING IRDC3622S EVALUATION BOARD USING IRF6622 AND IRF6678 DIRECTFET MOSFETS

DESCRIPTION

This user guide contains the schematic and bill of materials for the IRDC3622S evaluation board. The guide describes operation and use of the evaluation board itself. The IR3622 IC is a dual channel synchronous buck controller, providing a cost-effective, high performance and flexible solution. The two channels can be configured to either two independent outputs or current sharing single output. The current share configuration is ideal for high current applications.

Key features offered by the IR3622 include configurable dual output, output voltage tracking, power up/down sequencing, programmable soft-

start ramp, pre-bias start-up, latched over-voltage protection, thermal protection, accurate reference voltage, on-board regulator, threshold sensitive Enable input, programmable switching frequency up to 600kHz and input under-voltage lockout for proper start-up.

An output over-current protection function and a hiccup current limit are implemented by sensing the voltage developed across the on-resistance of the synchronous rectifier MOSFET for optimum cost and performance. Detailed application information for the IR3622 integrated circuit is available in the IR3622 data sheet.

BOARD FEATURES

- The board is designed for 1.8V output up to 60A load using IR3622 in current share configuration.
- $V_{IN} = +12V$, (13.2V Max)
- $V_o = +1.8V \pm 3\% @ 60A$
- $V_o(\text{ripple}) = 50\text{mV}$ maximum
- $F_s = 375\text{kHz}$
- $L = 270\text{nH}$ (10x10mm)
- $C_o = 4 \times 220\mu\text{F}$ (SP) + 10x10uF (ceramic 0805)
- Two 10x10mm inductors combined with 4x220 SP capacitors and 10x10uF ceramic capacitors form a compact solution.
- The input voltage start threshold of the converter is set about 10V using enable pin and two external resistors (R22B1 and R22B2).
- The converter has the option to sequence with other supplies using SEQ and Track pins (R6B1, R22B3 and R22B4). These pins are pulled high as default.

CONNECTIONS and OPERATING INSTRUCTIONS

Input Supplies Connection:

Two supplies are required for this board, 3.3V and 12V. Both supplies should be well regulated. The 3.3V supplies the pull-up resistor for Power Good. The Track and Seq pins are also pulled high using 3.3V. Connect the 3.3V supply to TP3(+) and TP4(Gnd). The 12V supply is the bus voltage; It also biases IR3622 IC and should be able to source 15A current. Connect this supply either to 8-pin connector (J1B) or solder other connectors, such as banana jacks, to the exposed pads.

Note: For correct start up the 3.3V supply needs to be powered first.

Output Load Connection:

The load can be connected to the large screw-terminals or solder other connectors such as banana jacks, to the exposed pads.

Table I. Connections

Signal Name	Connection
+3.3V Supply	TP3
Ground of the 3.3V Supply	TP4
V_{IN} (+12V)	J1B
Ground of V_{IN}	
V_{OUT} (+1.8V)	TB1B, TB2B
Ground of V_{OUT}	TB3B, TB4B

CONNECTION DIAGRAM

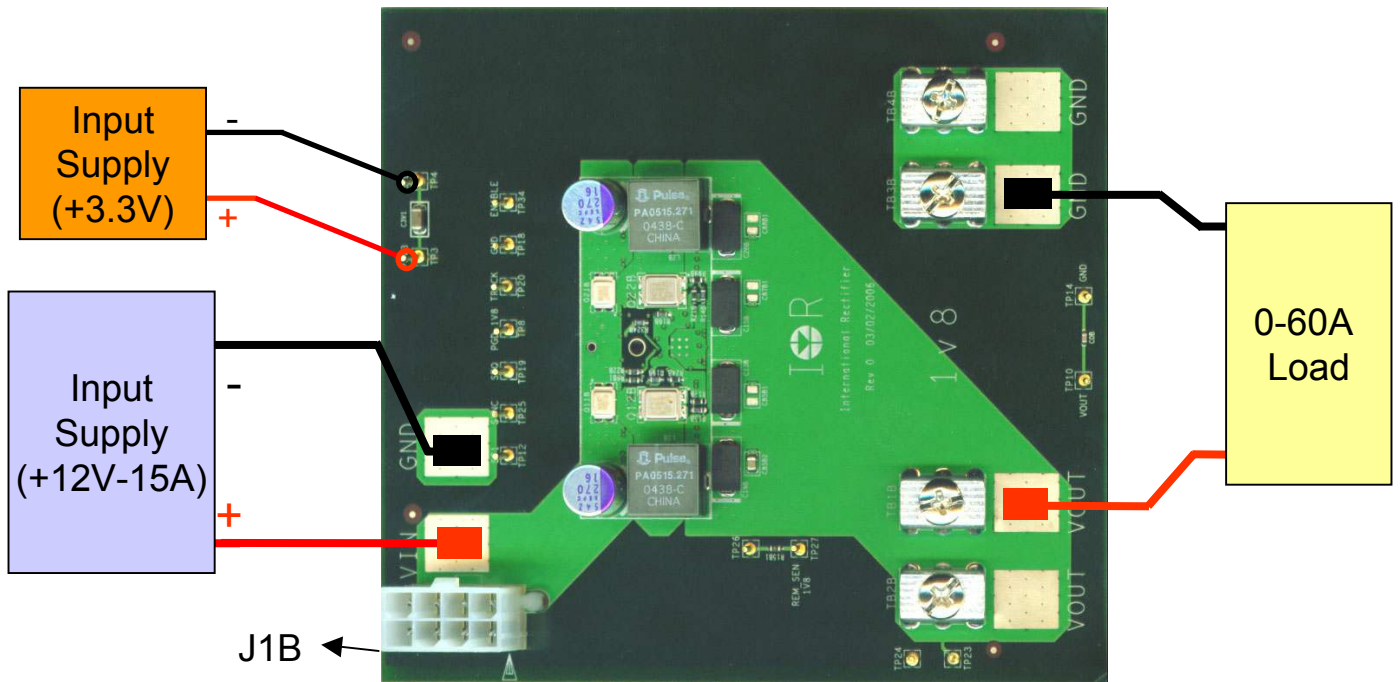

Fig. 1: Connection diagram of the IRDC3622S evaluation board.

Test Points

Input, output, and control signals are accessible through test points as listed in Table II.

Table II. Test Points

Test Point	Signal Name	Description
TP12	SS1	Soft Start
TP25	SYNC	External Synchronization Signal
TP19	SEQ	Enable input for Sequence and Tracking
TP8	PGD_1V8	Power Good output
TP20	TRACK	Sets the type of power up/down sequencing
TP18, TP24	GND	Ground
TP34	ENABLE	Enable input of the 3622 IC
TP10, TP14	V _{out}	Output voltage and Ground
TP26, TP27	REM_SEN1V8	Remote Sensing at Terminal Block, for Bode plot measurement
TP23	V _{out} Test	Test point for the output voltage

LAYOUT

The IRDC3622S is an eight-layer board. The top and bottom layers are 2 Oz. copper and the internal layers are 1 Oz. copper. The switching MOSFETS, Inductors, 270uF input capacitors, 220uF output capacitors, and some smaller passive components are mounted on the top side of the board. The IR3622 IC and the rest of passive components are mounted on the bottom layer. The DirectFET technology is used for MOSFETs.

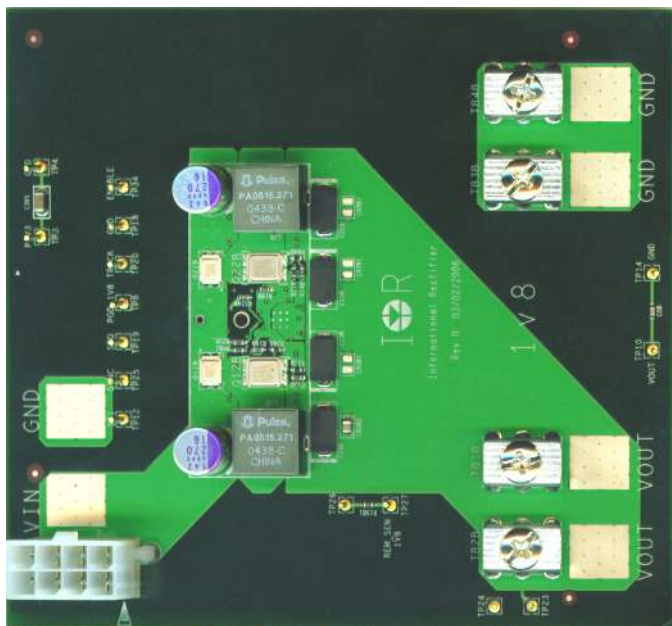

Fig. 2: Parts placement, top layer.

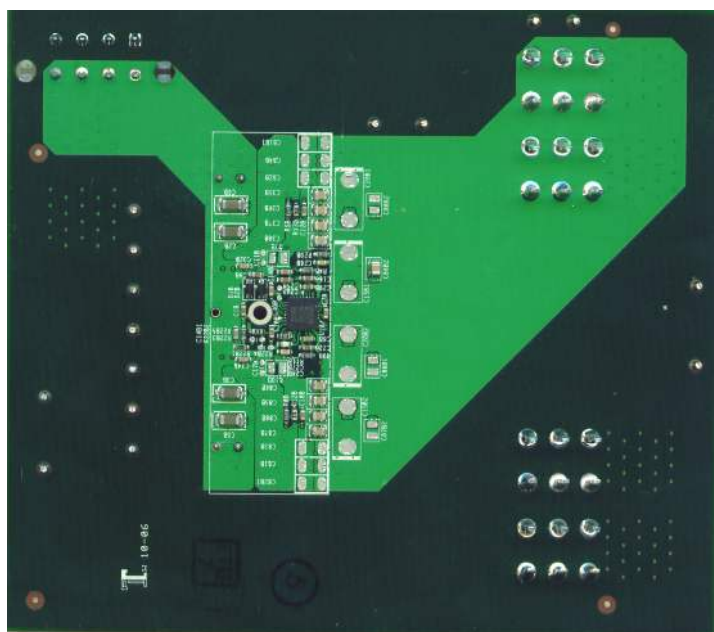

Fig. 3: Parts placement, bottom layer.

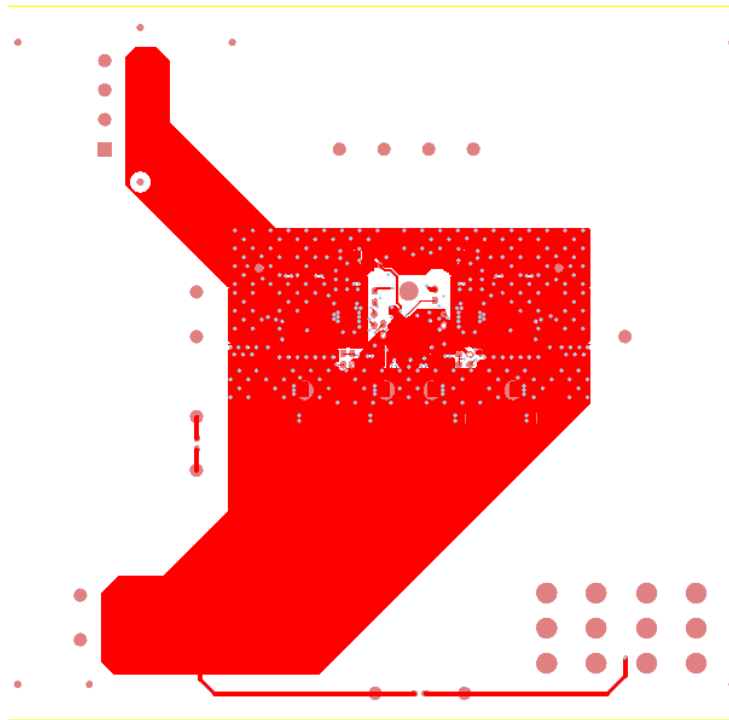

Fig. 4: Board layout, top layer.

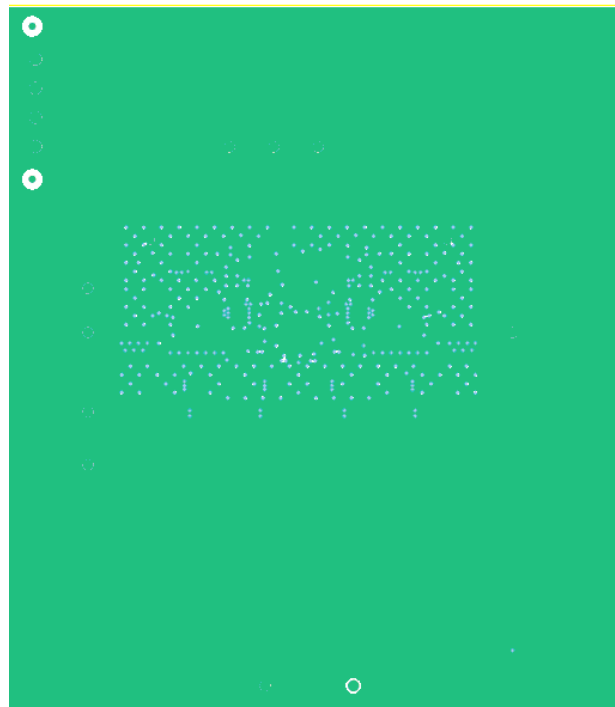

Fig. 5: Board layout, mid layer 1.

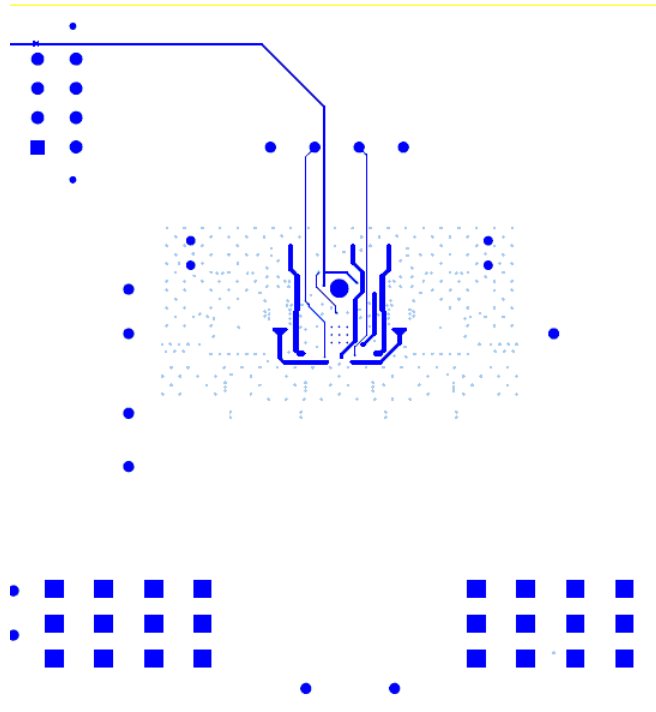

Fig. 6: Board layout, mid layer 2.

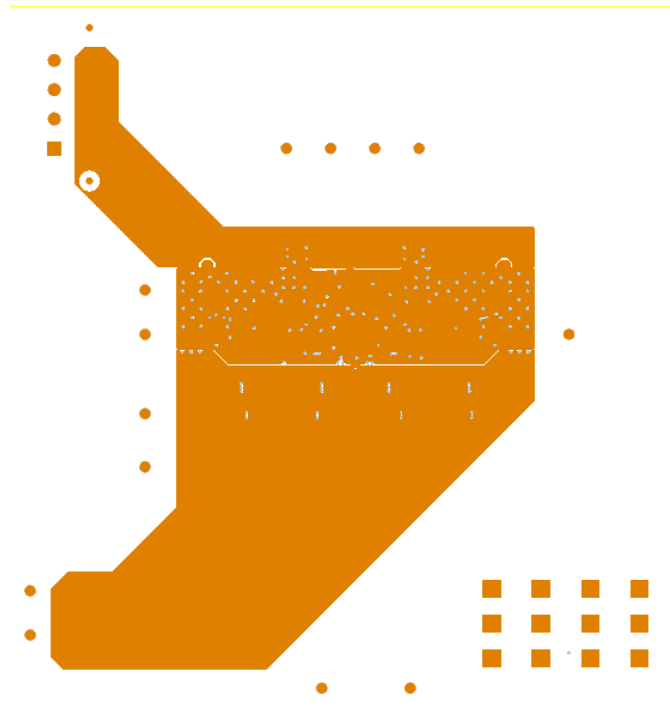

Fig. 7: Board layout, mid layer 3.



Fig. 8: Board layout, mid layer 4.

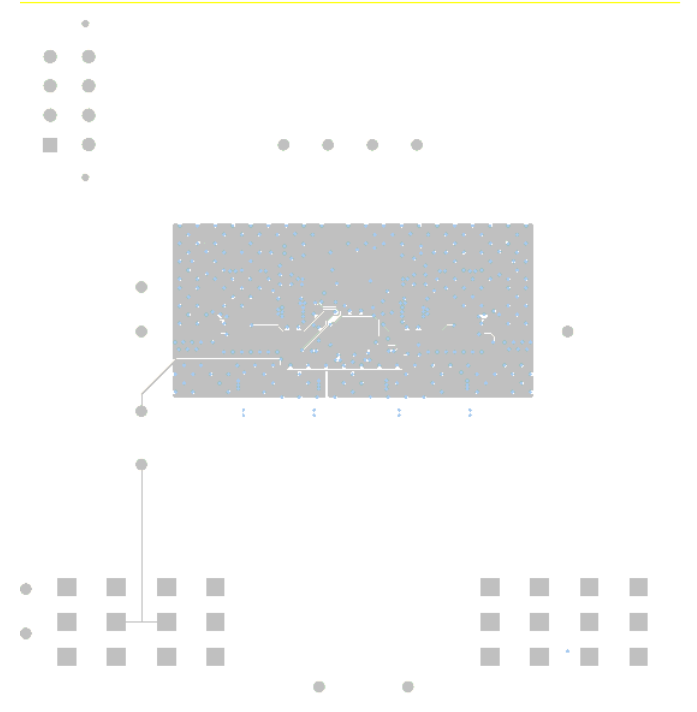

Fig. 9: Board layout, mid layer 5.

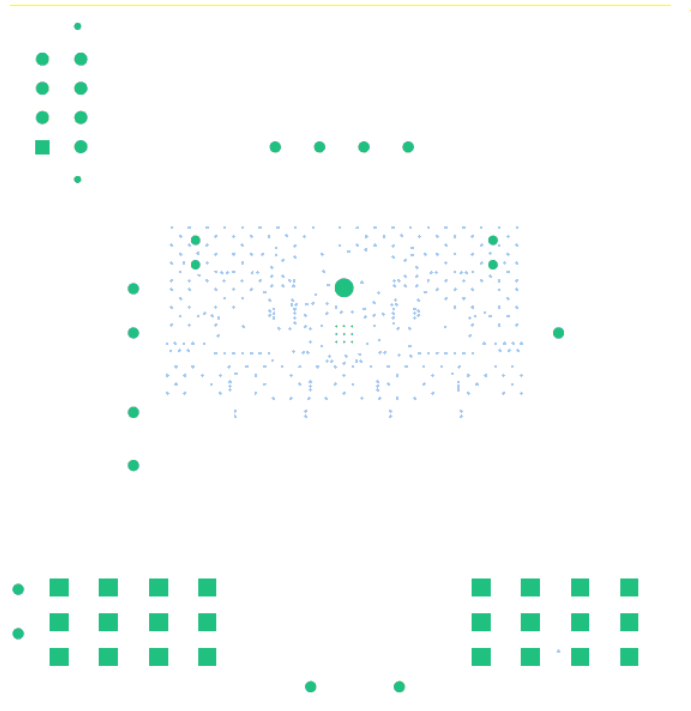

Fig. 10: Board layout, mid layer 6.

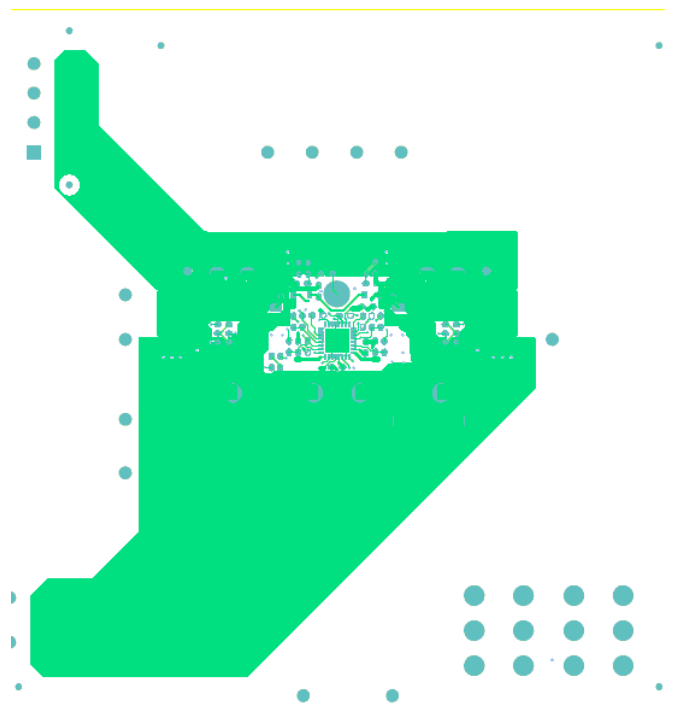

Fig. 11: Board layout, bottom layer.

UNLESS OTHERWISE SPECIFIED:
Capacitors are 10% max, 16V min, XSR min
Resistors are 1%, 100mW

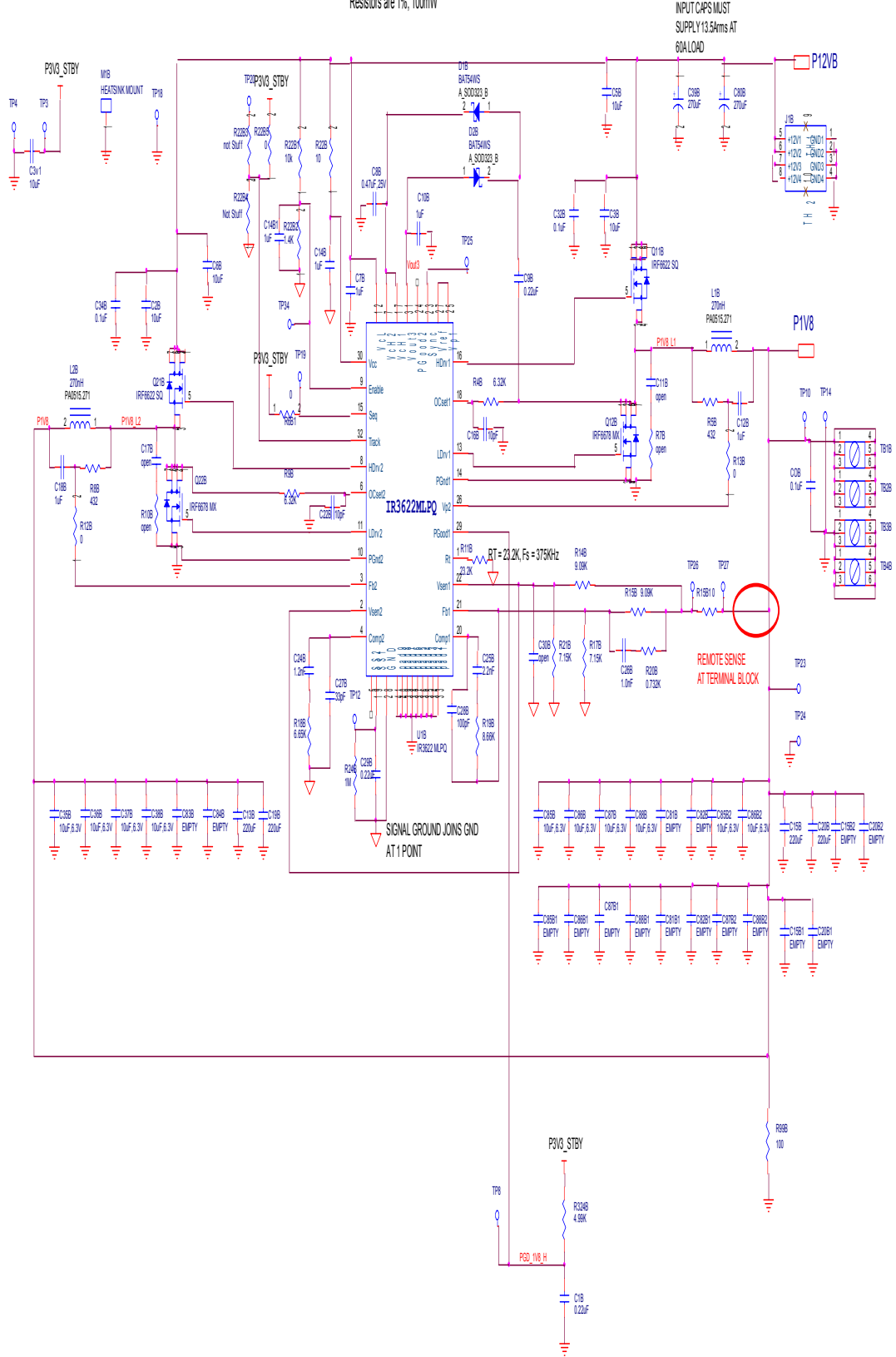

Fig. 12: Schematic of the IRDC3622S board.

BILL OF MATERIALS

Item	Qty	Reference	Value	Description	PCB Footprint	Manufacturer	Part Number
1	3	C32B, C34B, COB	0.1uF	0.1uF-0603-25V-X7R-10%	A MC-0603	Panasonic	ECJ1VB1E104
2	1	C30B	Open		A MC-0603		
3	5	C2B, C3B, C5B, C6B, C3v1	10uF	10uF-1206-16V-X7R-20%	A MC-1206	Murata	GRM31CR61C106KC31L
4	6	C7B, C10B, C12B, C14B, C18B, C14B1	1uF	1uF, 0603, 16V, X7R- 10%	A MC-0603	Murata	GRM188R71C105KA12D
5	1	C8B	0.47uF	0.47uF-0603-25V-X7R-10%	A MC-0603	Murata	GRM188R71E474KA12D
6	3	C1B, C9B, C29B	0.22uF	0.22uF-0603-16V-X7R-10%	A MC-0603	Panasonic	ECJ1VB1C224
7	2	C11B, C17B	Open		A MC-0603		
8	4	C13B, C15B, C19B, C20B	220uF	220uF-D4-2V-9mOhm-SP	A MC-6MM	Panasonic	EEFSX0D221R
9	2	C16B, C22B	10pF	10pF-0603-50V-C0G-5%	A MC-0603	Panasonic	ECJ1VC1H100D
10	1	C24B	1.2nF	1200pF-0603-50V-X7R-10%	A MC-0603	Panasonic	ECJ1VB1H122K
11	1	C25B	2.2nF	2200pF-0603-50V-X7R-10%	A MC-0603	Panasonic	ECJ1VB1H222K
12	1	C26B	1.0nF	1000pF-0603-50V-X7R-10%	A MC-0603	Panasonic	ECJ1VB1H102K
13	1	C27B	33pF	33pF-0603-50V-C0G-5%	A MC-0603	Panasonic	ECJ1VC1H330J
14	1	C28B	100pF	100pF-0603-50V-C0G-5%	A MC-0603	Panasonic	ECJ1VC1H101J
15	10	C35B, C36B, C37B, C38B, C85B, C86B, C87B, C88B, C85B2, C86B2	10uF	10uF-0805-6.3V-X5R-10%	A MC-0805	AVX	08056D106KAT2A
16	2	C39B, C80B	270uF	270uF-8mOhm-16V	A MC138-336D	Sanyo	16SEPC270M
17	6	C81B, C81B1, C82B, C83B, C84B, C82B1	Open		A MC-1206		
18	4	C15B1, C15B2, C20B1, C20B2	Open		A MC-6MM		
19	6	C85B1, C86B1, C87B1, C87B2, C88B1, C88B2	Open		A MC-0805		
20	2	D1B, D2B	BAT54WS	Schottky, SOD323, 30V, 0.2A	A SOD323_B	IR	BAT54WS
21	1	J1B	ATX8PINS	CONN, 8 Pins, 2 Rows	PWR2X4	Molex	39299082
22	2	L1B, L2B	270nH		A INDUCT-515	Pulse	PA0515.271
23	2	Q11B, Q21B	IRF6622 SQ	IRF6622 SQ 25V	IR DIRFET SQ	IR	IRF6622
24	2	Q12B, Q22B	IRF6678 MX	IRF6678 MX 30V	IR DIRFET MX	IR	IRF6678
25	1	R324B	4.99K	RES, 0603, 1%, 1/10W	A CR-0603	Rohm	MCR03EZPF4991
26	2	R4B, R9B	6.34K	RES, 0603, 1%, 1/10W	A CR-0603	Rohm	MCR03EZPF6341
27	2	R5B, R8B	432	RES, 0603, 1%, 1/10W	A CR-0603	Rohm	MCR03EZPF4320
28	2	R7B, R10B	Open		A CR-0805		
29	1	R11B	23.2K	RES, 0603, 1%, 1/10W	A CR-0603	Rohm	MCR03EZPF2322
30	5	R12B, R13B, R6B1, R15B1, R22B5	0	RES, 0603, 1%, 1/10W	A CR-0603	Rohm	MCR03EZPJ000
31	1	R14B	9.09K	RES, 0603, 1%, 1/10W	A CR-0603	Rohm	MCR03EZPF9091
32	1	R15B	9.09K	RES, 0603, 1%, 1/10W	A CR-0603	Rohm	MCR03EZPF9091
33	1	R22B	10	RES, 0603, 1%, 1/10W	A CR-0603	Panasonic	ERJ-3EKF10R0V
34	1	R99B	100	RES, 0603, 1%, 1/10W	A CR-0603	Rohm	MCR03EZPF1000
35	2	R17B, R21B	7.15K	RES, 0603, 1%, 1/10W	A CR-0603	Rohm	MCR03EZPF7151
36	1	R18B	6.65K	RES, 0603, 1%, 1/10W	A CR-0603	Rohm	MCR03EZPF6651
37	1	R19B	8.66K	RES, 0603, 1%, 1/10W	A CR-0603	Rohm	MCR03EZPF8661
38	1	R20B	732	RES, 0603, 1%, 1/10W	A CR-0603	Rohm	MCR03EZPF7320
39	1	R24B	1M	RES, 0603, 1%, 1/10W	A CR-0603	Yageo	RC0603FR-071ML
40	1	R22B1	10k	RES, 0603, 1%, 1/10W	A CR-0603	Yageo	RC0603FR-0710KL
41	1	R22B2	1.4K	RES, 0603, 1%, 1/10W	A CR-0603	Panasonic	ERJ-S03F1401V
42	2	R22B3, R22B4	Open		A CR-0603		
43	4	TB1B, TB2B, TB3B, TB4B	T. BLOCK 1 PIN	Terminal block	TB 1 0	Keystone	8197
44	15	TP3, TP4, TP8, TP10, TP12, TP14, TP18, TP19, TP20, TP23, TP24, TP25, TP26, TP27, TP34	TP	Testpoint	V1054_ND	Vector	K24A/M
45	1	U1B	IR3622 MLPQ	Controller	A MLPQ32-0P5MM VIA A	International Rectifier	IR3622
46	1	M1B	Heat Sink	26.65 x 19.48 x 22.48 (L x W x H) (mm)		ThermaFlo	7201599
47	2	TIM1B, TIM2B	Thermal Interface Material	10.20 x 19.12 (L x W) (mm)		Bergquist	BG420753
48	1	SCRW1B	Philips Pan Head Screw	Stainless A-2(18-8), 2mm x .4 x 5mm		Bolt Depot	6812

TYPICAL OPERATING WAVEFORMS

$V_{in}=12V$, $V_o=1.8V$, $I_o=0-60A$, $F_s=375\text{ kHz}$, Room Temperature, No Air Flow

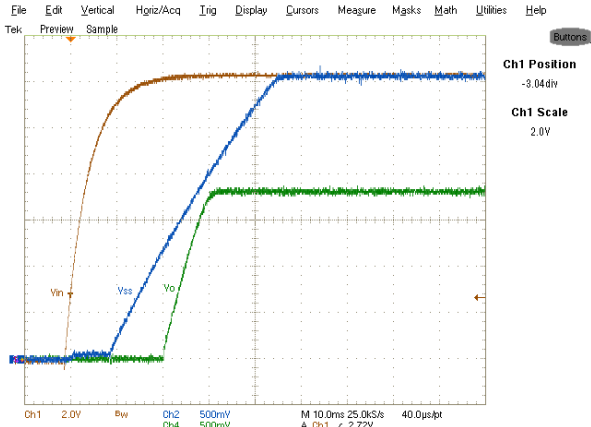

Fig.13: Start-up sequence at no load.
Ch₁: V_{in} , Ch₂: V_{ss} , Ch₄: V_o

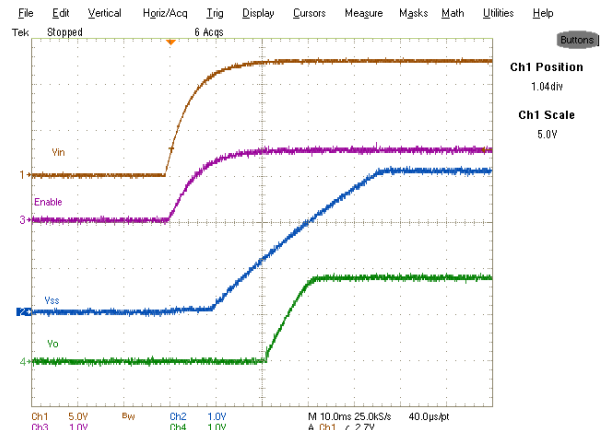

Fig.14: Start-up sequence into 60A load.
Ch₁: V_{in} , Ch₂: V_{ss} , Ch₃: Enable, Ch₄: V_o

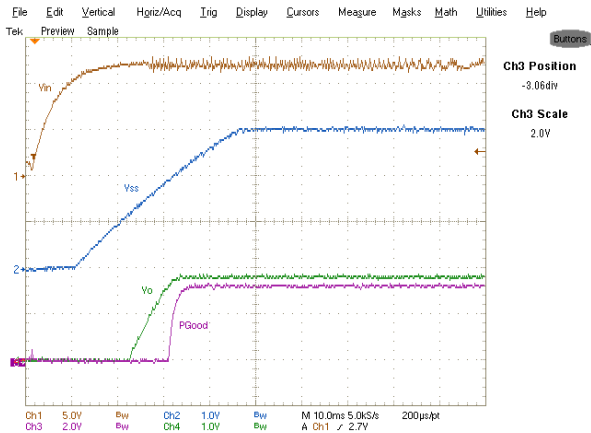

Fig.15: Start-up sequence into 60A load.
Ch₁: V_{in} , Ch₂: V_{ss} , Ch₃: Power Good, Ch₄: V_o

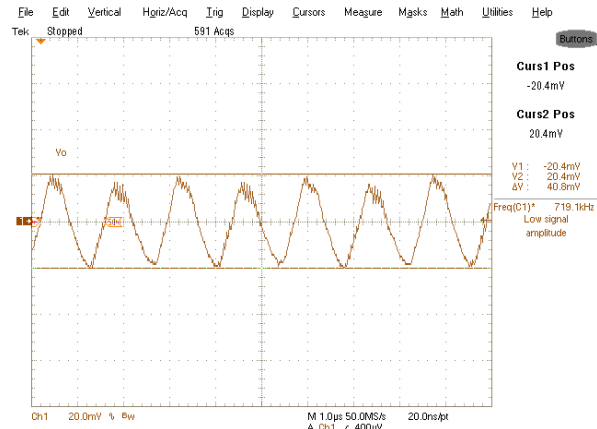

Fig.16: Output Voltage ripple at 40 A.

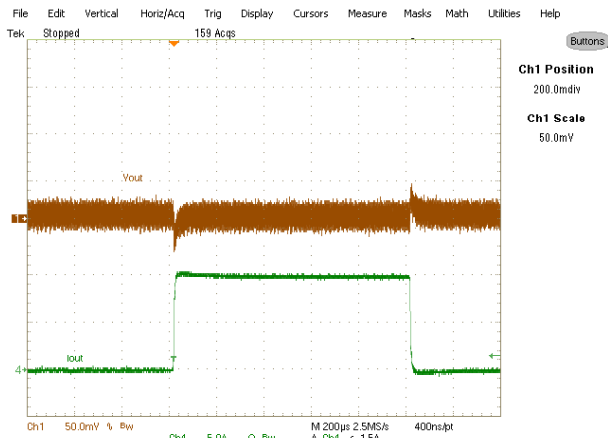

Fig.17: Transient response.
Ch₁: V_o , Ch₄: I_o (0-10A)

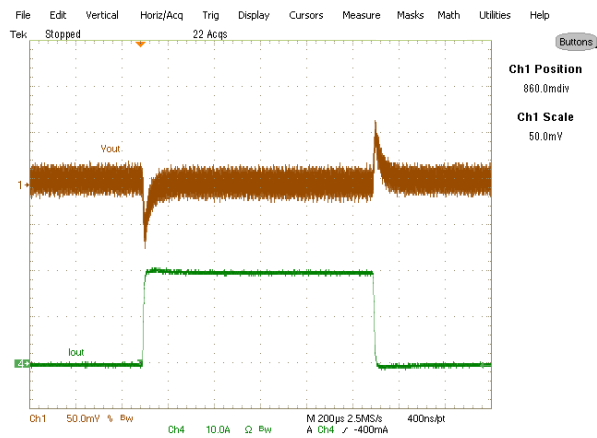

Fig.18: Transient response.
Ch₁: V_o , Ch₄: I_o (0-20A)

TYPICAL OPERATING WAVEFORMS
 $V_{in}=12V$, $V_o=1.8V$, $I_o=0-60A$, $F_s=375\text{ kHz}$, Room Temperature, No Air Flow

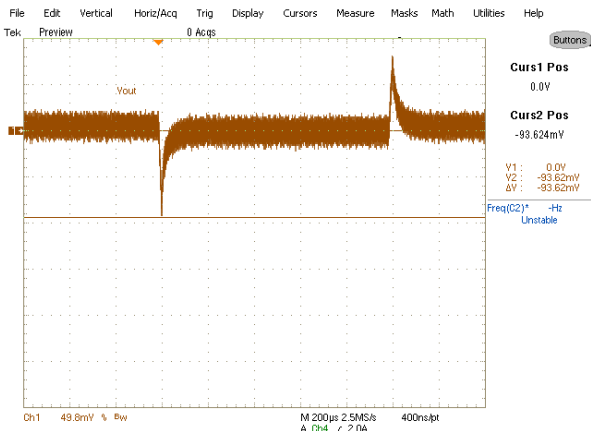

Fig. 19: Transient response $I_{out}(0-30A)$.
 Ch1: V_{out}

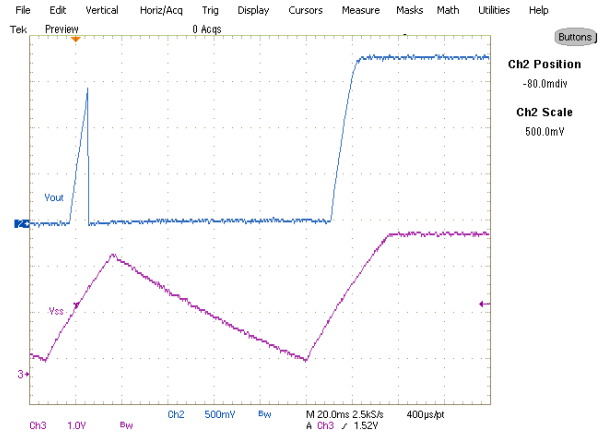

Fig. 20: Transition from hiccup to normal operation. $Ch_2: V_{out}$, $Ch_3: V_{ss}$

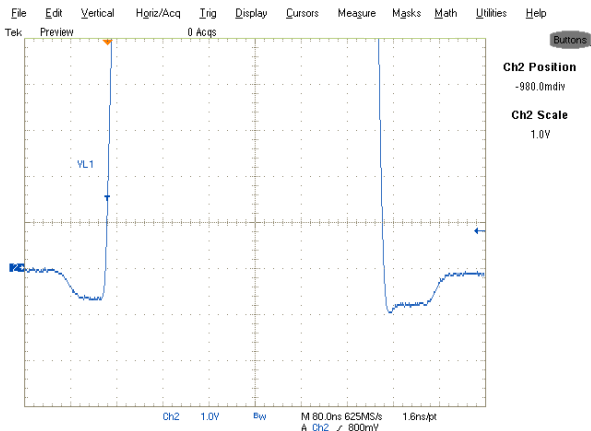

Fig. 21: Dead-times on V_{L1} at 40A.

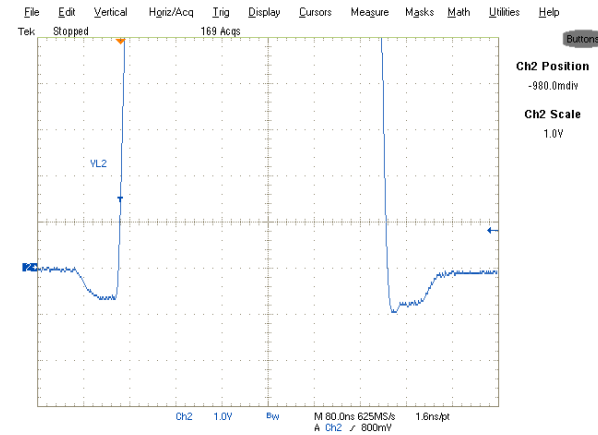

Fig. 22: Dead-times on V_{L2} at 40 A.

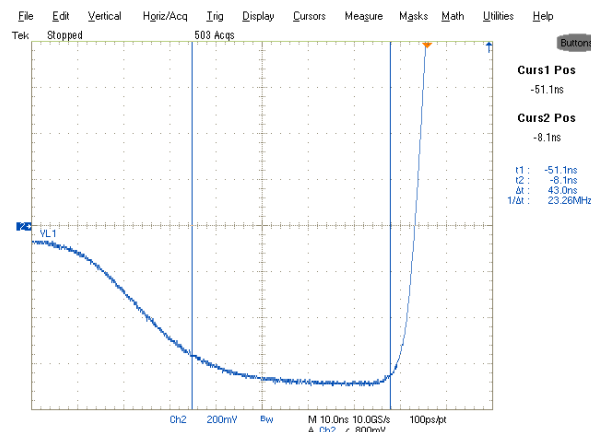

Fig. 23: V_{L1} -turn-on dead-time at 40A.

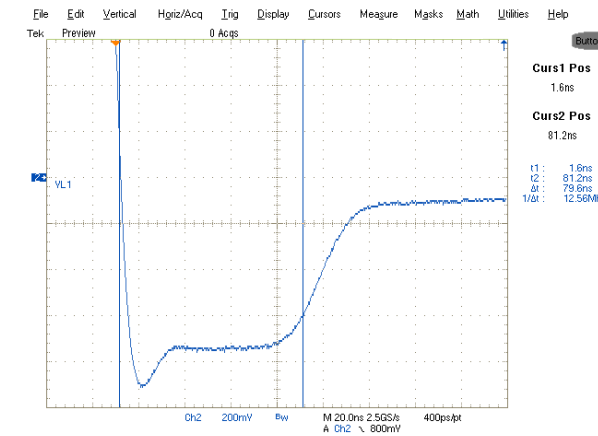

Fig. 24: V_{L1} -turn-off dead-time at 40A.

TYPICAL OPERATING WAVEFORMS

V_{in}=12V, V_o=1.8V, I_o=0-60A, F_s=375 kHz, Room Temperature, No Air Flow

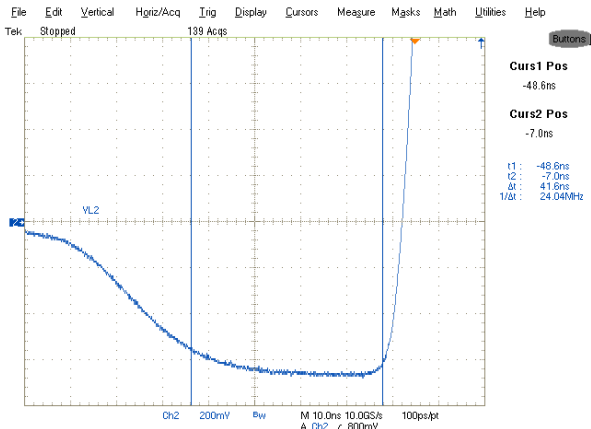

Fig. 25: V_{L2}-turn-on dead-time at 40A.

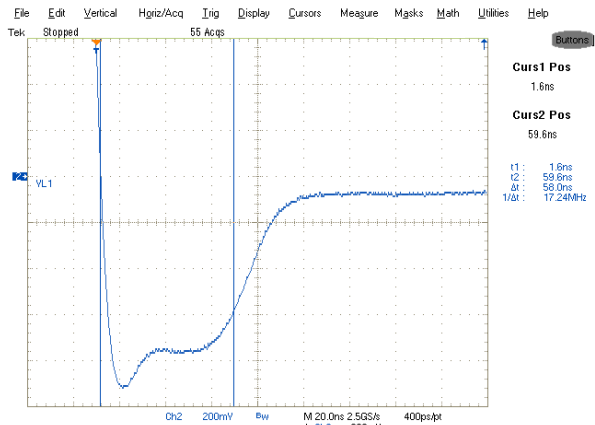

Fig. 26: V_{L2}-turn-off dead-time at 40A.

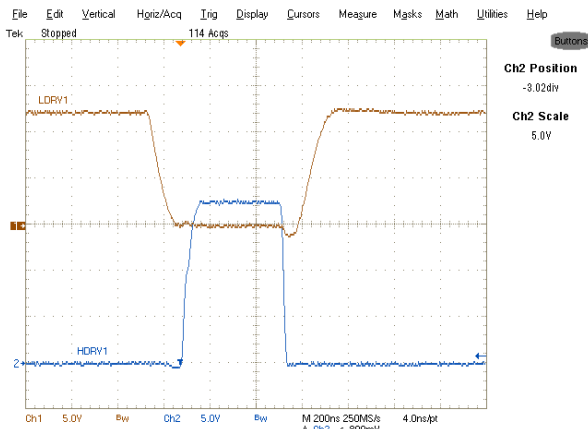

Fig. 27: HDRV1 and LDRV1 at 20A.
Ch₁: LDRV1, Ch₂: HDRV1

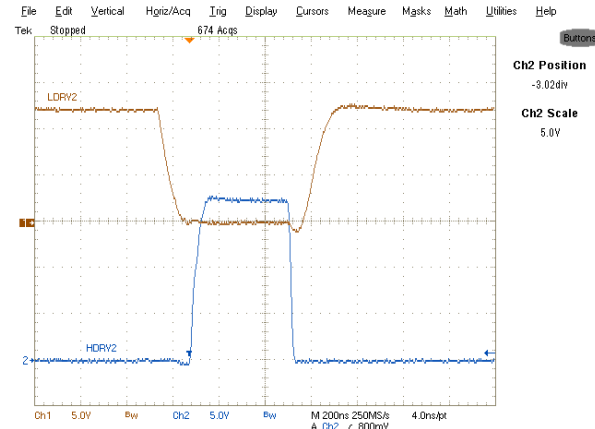

Fig. 28: HDRV2 and LDRV2 at 20A.
Ch₁: LDRV2, Ch₂: HDRV2

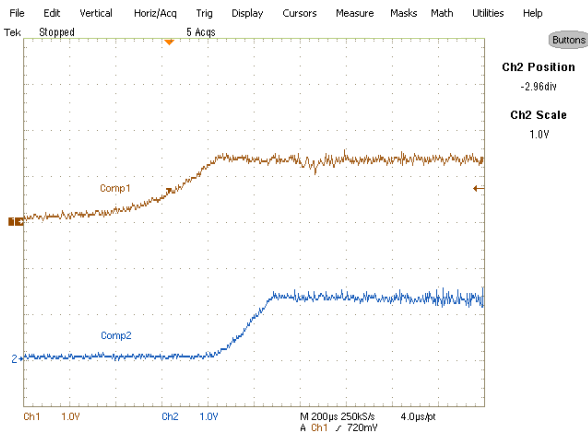

Fig. 29: Compensator signals at start-up to a 20A load. Ch₁: Comp1, Ch₂: Comp2

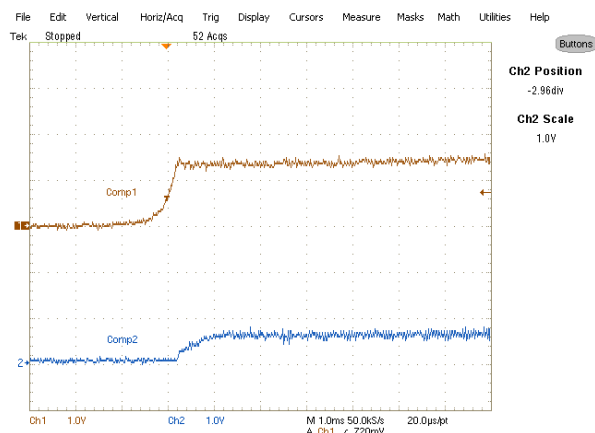

Fig. 30: Compensator signals at No load.
Ch₁: Comp1, Ch₂: Comp2

TYPICAL OPERATING WAVEFORMS

V_{in}=12V, V_o=1.8V, I_o=0-60A, F_s=375 kHz, Room Temperature, No Air Flow

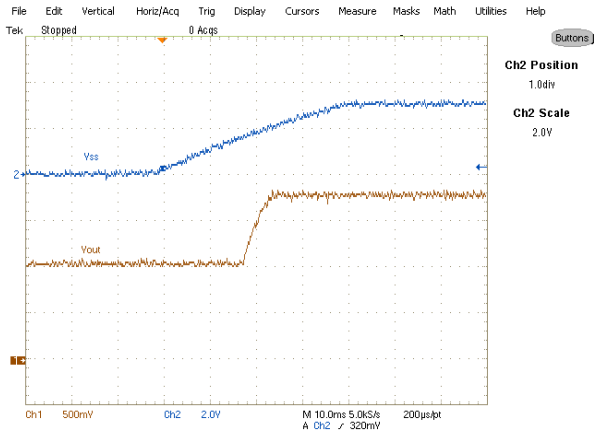

Fig. 31: Pre-bias test at 1V.

Ch₁: V_{out}, Ch₂: V_{ss}

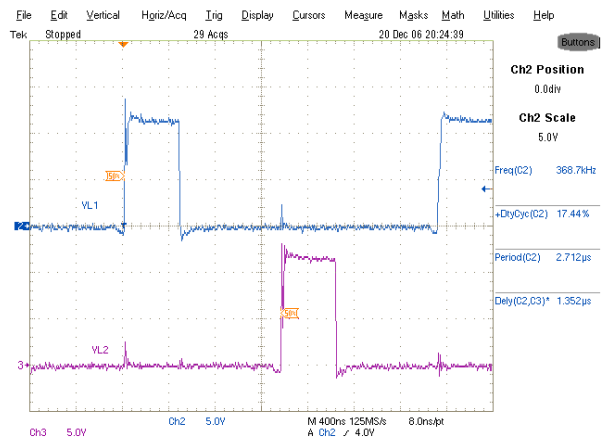

Fig. 32: Inductor points at 60A load.

Ch₂: V_{L1}, Ch₃: V_{L2}

TYPICAL OPERATING WAVEFORMS

$V_{in}=12V$, $V_o=1.8V$, $I_o=0-60A$, $F_s=375\text{ kHz}$, 45°C Ambient Temperature, 200LFM Air Flow

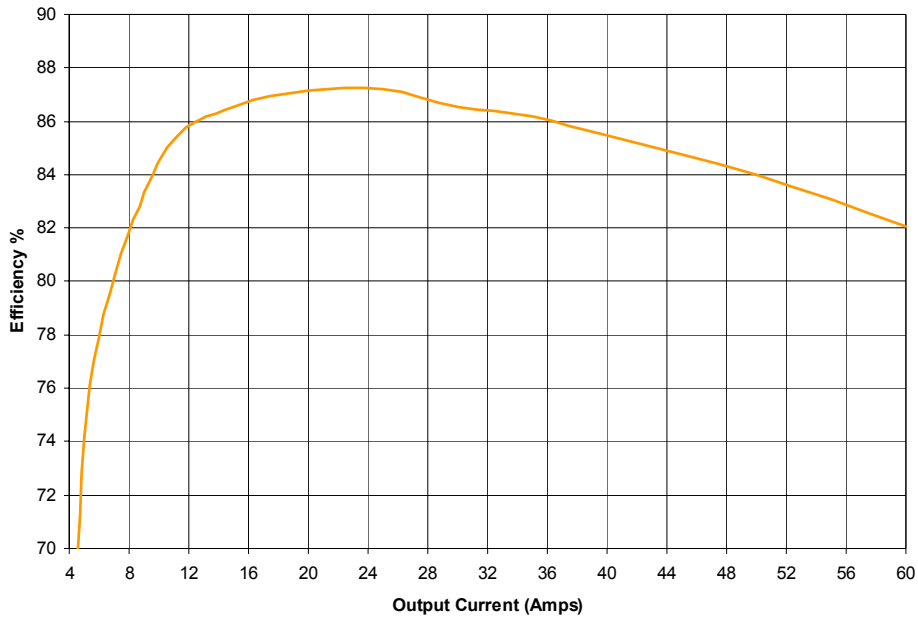

Fig. 33: Efficiency versus load current at 45°C with heat sink and 200LFM air flow.

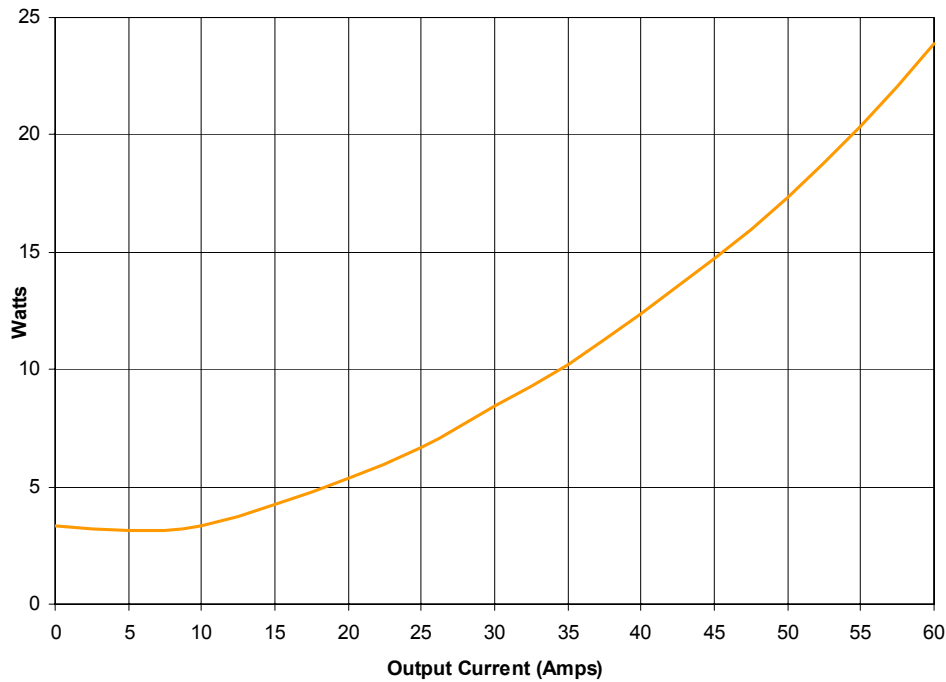

Fig. 34: Power loss versus load current at 45°C with heat sink and 200LFM air flow

TYPICAL OPERATING WAVEFORMS

$V_{in}=12V$, $V_o=1.8V$, $I_o=0-60A$, $F_s=375\text{ kHz}$, Room Temperature, No Air Flow

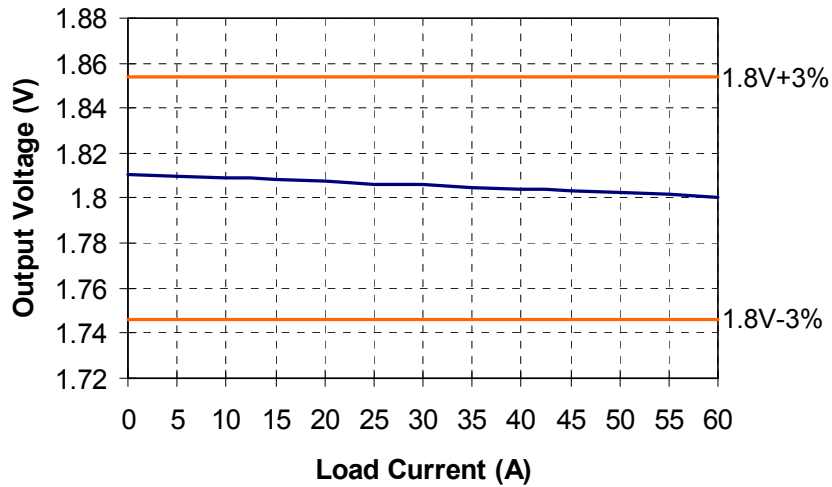

Fig. 35: Output voltage versus load current.

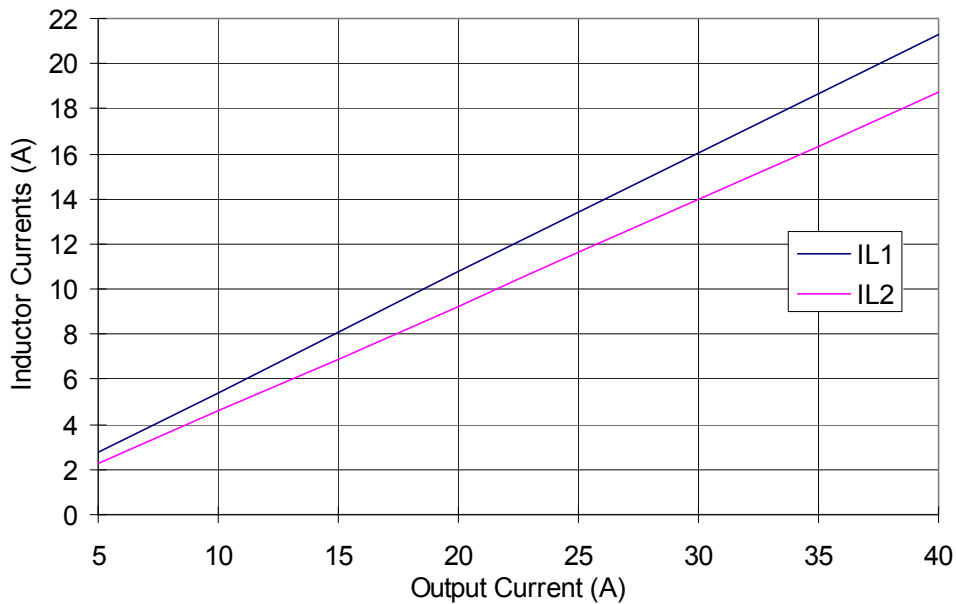

Fig. 36: Current Sharing of the phases versus load current.

TYPICAL OPERATING WAVEFORMS

Vin=12V, Vo=1.8V, Io=0-60A, Fs=375 kHz, Room Temperature, No Air Flow

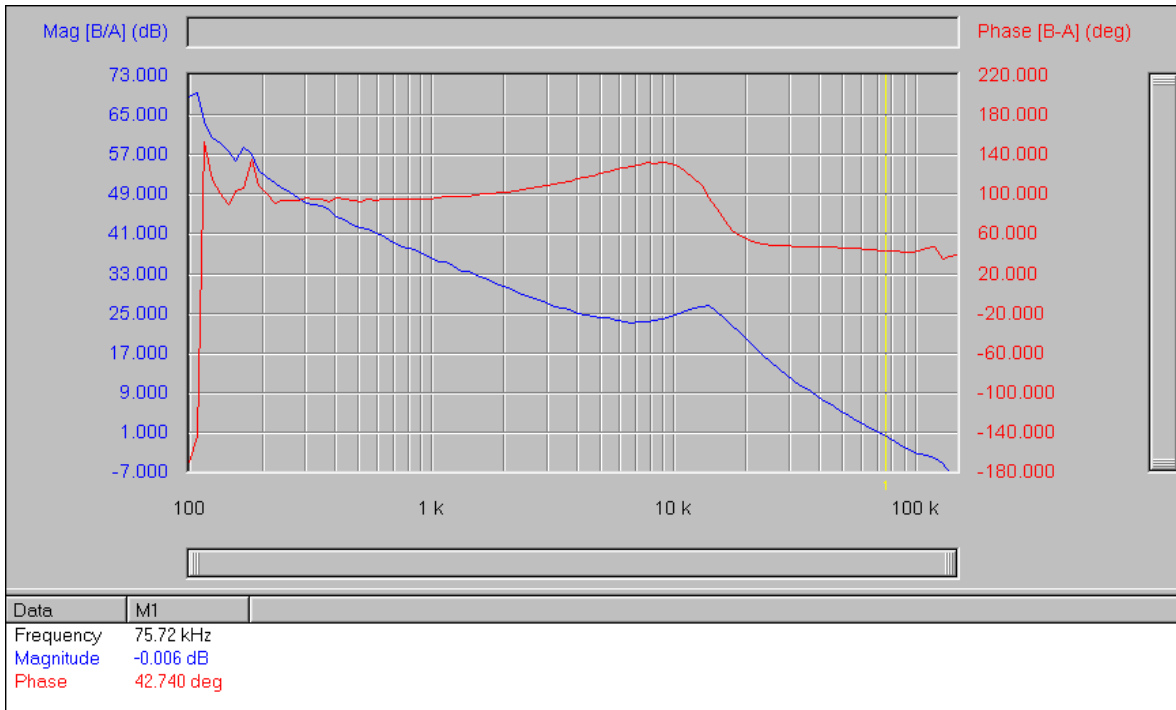

Fig. 37: Bode Plot at 20 A load shows a bandwidth of 75kHz and phase margin of 42.7 degree.

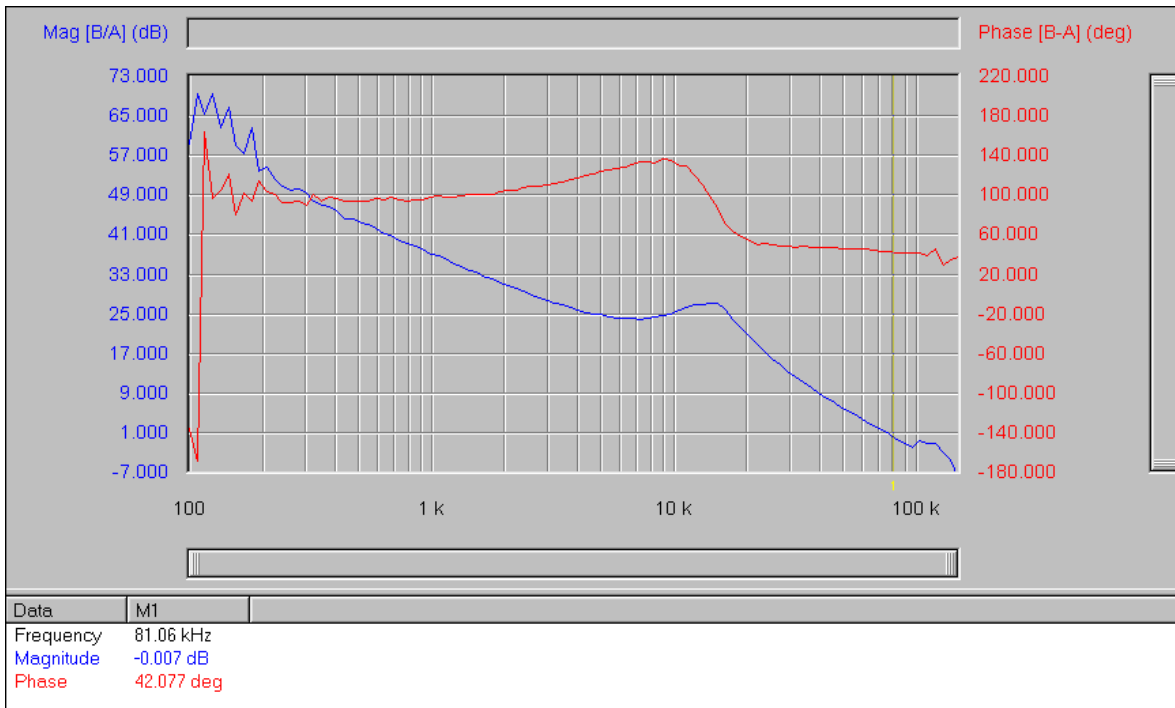

Fig. 38: Bode Plot at 40 A load shows a bandwidth of 81kHz and phase margin of 42.1 degree.

TYPICAL OPERATING WAVEFORMS

Vin=12V, Vo=1.8V, Io=0-60A, Fs=375 kHz, Room Temperature, No Air Flow

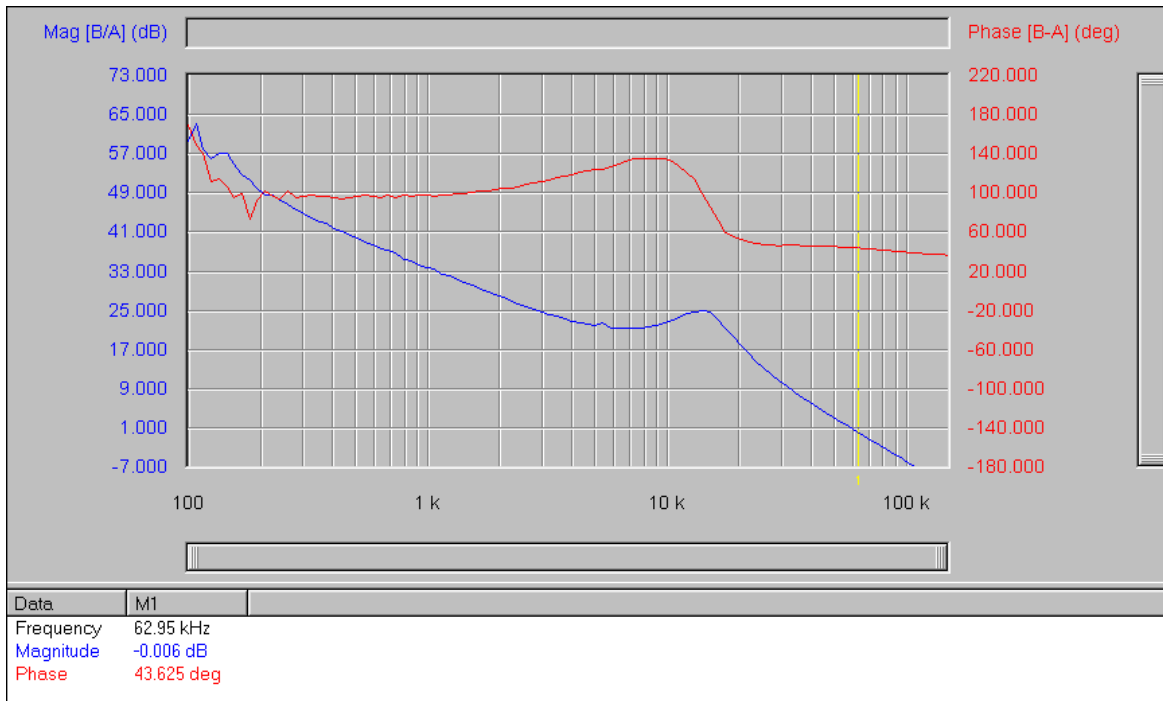

Fig. 39: Bode Plot at 60 A load shows a bandwidth of 62.9kHz and phase margin of 43.6 degree.

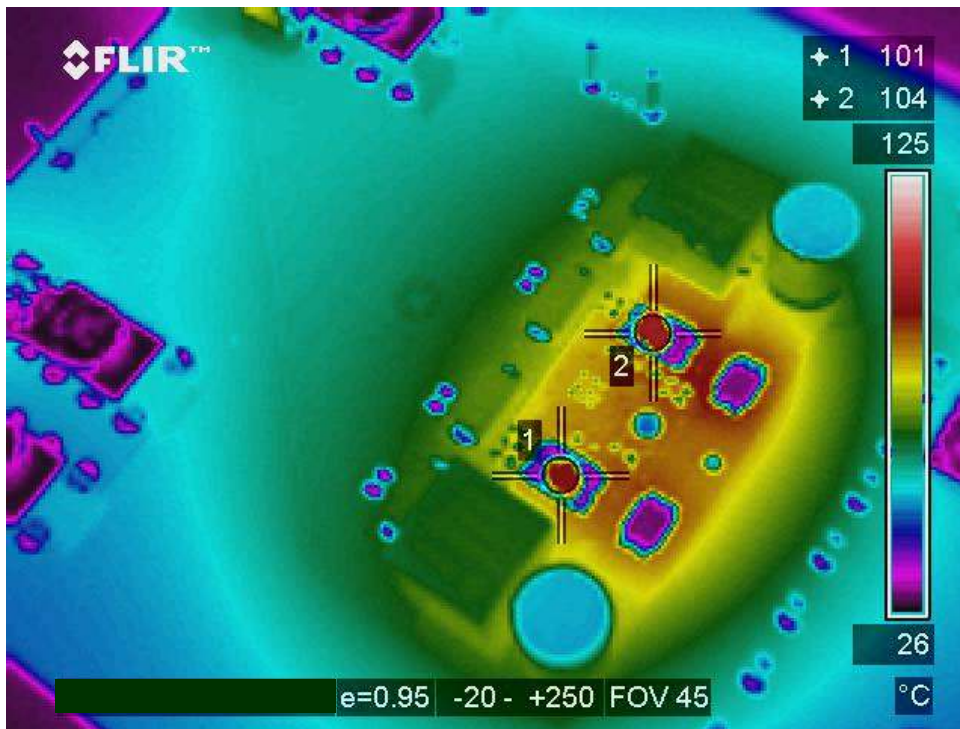
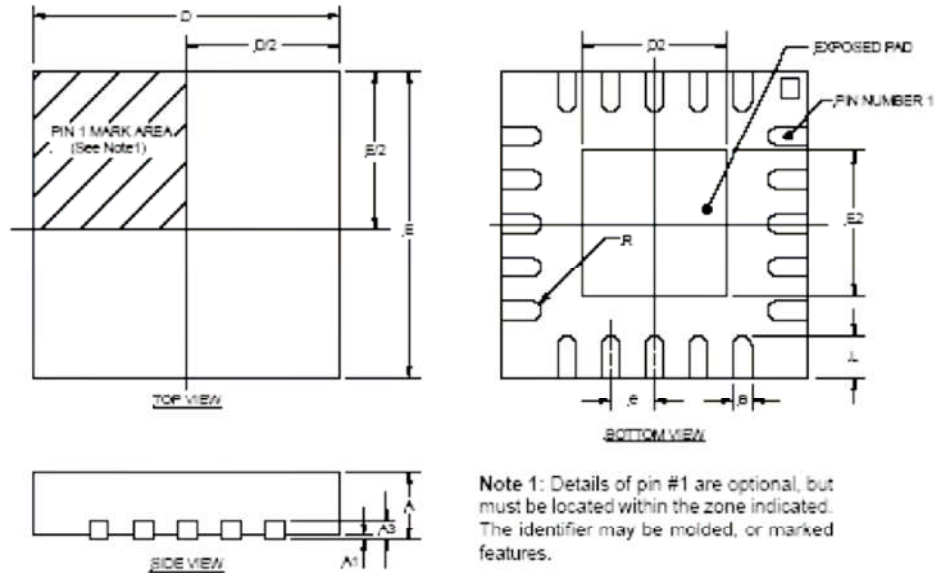

Fig. 40: Thermal Image at 60 A load, without heatsink, and with no air flow, Test Points are Synchronous Rectifier DirectFETs.

(IR3622M) MLPQ Package; 5x5-32 Lead



SYMBOL	32-PIN 5x5		
	MIN	NOM	MAX
A	0.80	0.90	1.00
A1	0.00	0.02	0.05
A3	0.20 REF		
B	0.18	0.23	0.30
D	5.00 BSC		
D/2	3.30	3.45	3.55
E	5.00 BSC		
E/2	3.30	3.45	3.55
e	0.50 BSC		
L	0.30	0.40	0.50
R	0.09	---	---

NOTE: ALL MEASUREMENTS ARE IN MILLIMETERS.

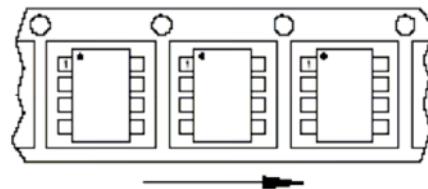

Feed Direction
 Figure A

IR WORLD HEADQUARTERS: 233 Kansas St., El Segundo, California 90245, USA Tel: (310) 252-7105
 TAC Fax: (310) 252-7903

This product has been designed and qualified for the Industrial market.

Visit us at www.irf.com for sales contact information

Data and specifications subject to change without notice. 1/23/2007