

Features

- **8MHz to 400MHz Input/Output Operation**
- **Low Output to Output Skew (<50ps)**
- **Low Jitter Peak-to-Peak**
- **Up to 20 Programmable Fan-out Buffers**
 - Programmable output standards and individual enable controls
 - LVTTTL, LVCMOS, HSTL, eHSTL, SSTL, LVDS, LVPECL, Differential HSTL, SSTL
 - Programmable output impedance
 - 40 to 70Ω in 5Ω increments
 - Programmable slew rate
 - Up to 10 banks with individual V_{CCO} and GND
 - 1.5V, 1.8V, 2.5V, 3.3V
- **Fully Integrated High-Performance PLL**
 - Programmable lock detect
 - Multiply and divide ratio controlled by
 - Input divider (1 to 40)
 - Feedback divider (1 to 40)
 - Five output dividers (2 to 80)
 - Programmable on-chip loop filter
 - Compatible with spread spectrum clocks
- **Precision Programmable Phase Adjustment (Skew) Per Output**
 - 16 settings; minimum step size 156ps
 - Locked to VCO frequency
 - Up to +/- 12ns skew range
 - Coarse and fine adjustment modes

- **Up to Five Clock Frequency Domains**
- **Flexible Clock Reference and External Feedback Inputs**
 - Programmable input standards
 - LVTTTL, LVCMOS, SSTL, HSTL, LVDS, LVPECL, Differential HSTL, SSTL
 - Clock A/B selection multiplexer
 - Feedback A/B selection multiplexer
 - Programmable termination
- **All Inputs and Outputs are Hot Socket Compliant**
- **Four User-programmable Profiles Stored in E²CMOS® Memory**
 - Supports both test and multiple operating configurations
- **Full JTAG Boundary Scan Test In-System Programming Support**
- **Exceptional Power Supply Noise Immunity**
- **Commercial (0 to 70°C) and Industrial (-40 to 85°C) Temperature Ranges**
- **100-pin and 48-pin TQFP Packages**
- **Applications**
 - Circuit board common clock generation and distribution
 - PLL-based frequency generation
 - High fan-out clock buffer
 - Zero-delay clock buffer

Product Family Block Diagram

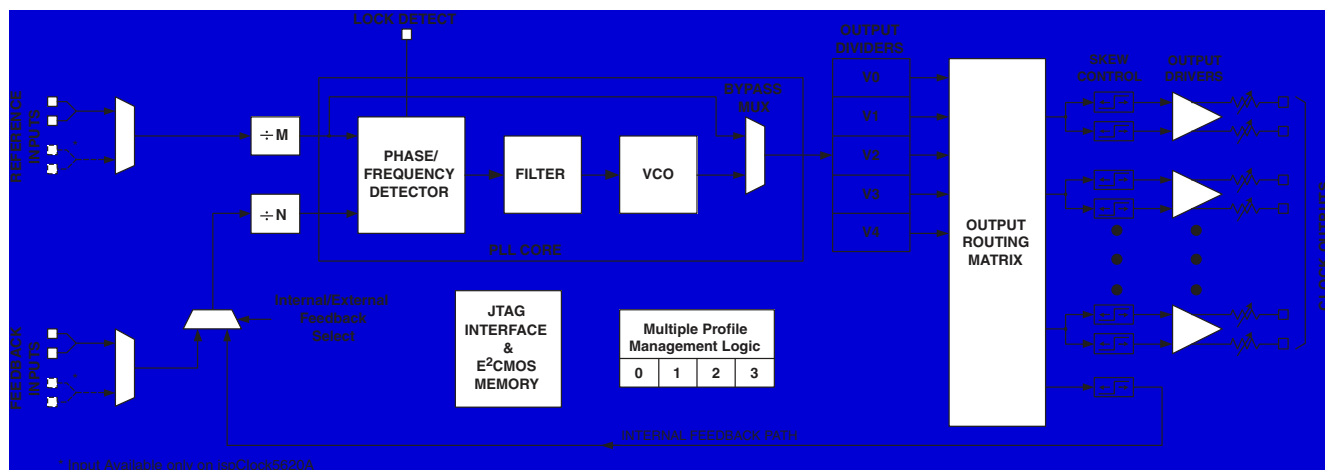

General Description and Overview

The ispClock5610A and ispClock5620A are in-system-programmable high-fanout enhanced zero delay clock generators designed for use in high performance communications and computing applications. The ispClock5610A provides up to 10 single-ended or five differential clock outputs, while the ispClock5620A provides up to 20 single-ended or 10 differential clock outputs. Each pair of outputs may be independently configured to support separate I/O standards (LVDS, LVPECL, LVTTTL, LVCMOS, SSTL, HSTL) and output frequency. In addition, each output provides independent programmable control of termination, slew-rate, and timing skew. All configuration information is stored on-chip in non-volatile E²CMOS memory.

The ispClock5600A's PLL and divider systems supports the synthesis of multiple clock frequencies derived from the reference input through the provision of programmable input and feedback dividers. A set of five post-PLL V-dividers provides additional flexibility by supporting the generation of five separate output frequencies. Loop feedback may be taken internally from the output of any of the five V-dividers, or externally through FBKA+/- or FBKB+/- pins.

The core functions of all members of the ispClock5600A family are identical, the differences between devices being restricted to the number of inputs and outputs, as shown in the following table. Figures 1 and 2 show functional block diagrams of the ispClock5610A and ispClock5620A.

Table 1-1. ispClock5600A Family Members

Device	Ref. Input Pairs	Feedback Input Pairs	Clock Outputs
ispClock5610A	1	1	10
ispClock5620A	2	2	20

Figure 1-1. ispClock5610A Functional Block Diagram

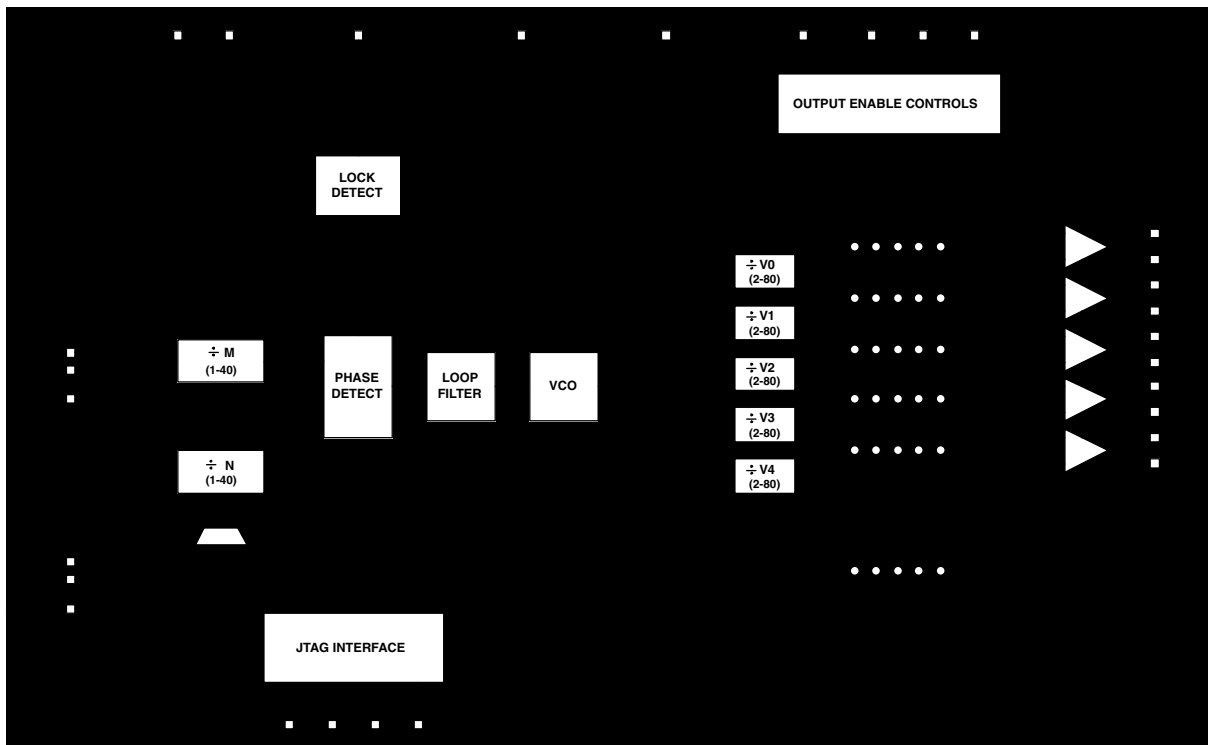
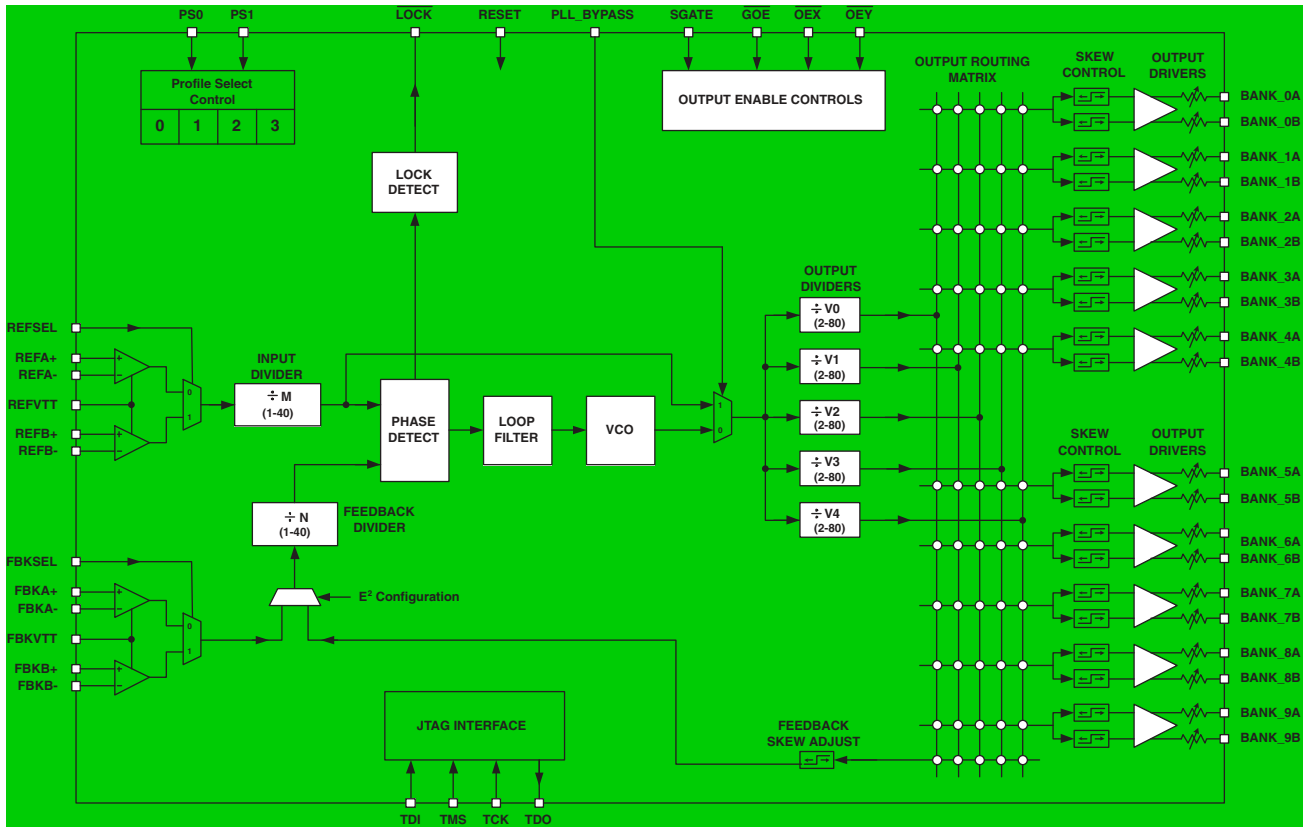

Figure 1-2. ispClock5620A Functional Block Diagram



Absolute Maximum Ratings

ispClock5600A

Core Supply Voltage V_{CCD} -0.5 to 5.5V
 PLL Supply Voltage V_{CCA} -0.5 to 5.5V
 JTAG Supply Voltage V_{CCJ} -0.5 to 5.5V
 Output Driver Supply Voltage V_{CCO} -0.5 to 4.5V
 Input Voltage -0.5 to 4.5V
 Output Voltage¹ -0.5 to 4.5V
 Storage Temperature -65 to 150°C
 Junction Temperature with power supplied -40 to 130°C

1. When applied to an output when in high-Z condition

Recommended Operating Conditions

Symbol	Parameter	Conditions	ispClock5600A		Units
			Min.	Max.	
V_{CCD}	Core Supply Voltage		3.0	3.6	V
V_{CCJ}	JTAG I/O Supply Voltage		2.25	3.6	V
V_{CCA}	Analog Supply Voltage		3.0	3.6	V
$V_{CCXSLEW}$	V_{CC} Turn-on Ramp Rate	All supply pins	—	0.33	V/ μ s
T_{JOP}	Operating Junction Temperature	Commercial	0	130	°C
		Industrial	-40	130	
T_A	Ambient Operating Temperature	Commercial	0	70 ¹	°C
		Industrial	-40	85 ¹	

1. Device power dissipation may also limit maximum ambient operating temperature.

Recommended Operating Conditions – V_{CCO} vs. Logic Standard

Logic Standard	V_{CCO} (V)			V_{REF} (V)			V_{TT} (V)		
	Min.	Typ.	Max.	Min.	Typ.	Max.	Min.	Typ.	Max.
LVTTTL	3.0	3.3	3.6	—	—	—	—	—	—
LVC MOS 1.8V	1.71	1.8	1.89	—	—	—	—	—	—
LVC MOS 2.5V	2.375	2.5	2.625	—	—	—	—	—	—
LVC MOS 3.3V	3.0	3.3	3.6	—	—	—	—	—	—
SSTL1.8	1.71	1.8	1.89	0.84	0.90	0.95	—	$0.5 \times V_{CCO}$	—
SSTL2 Class 1	2.375	2.5	2.625	1.15	1.25	1.35	$V_{REF} - 0.04$	V_{REF}	$V_{REF} + 0.04$
SSTL3 Class 1	3.0	3.3	3.6	1.30	1.50	1.70	$V_{REF} - 0.05$	V_{REF}	$V_{REF} + 0.05$
HSTL Class 1	1.425	1.5	1.575	0.68	0.75	0.90	—	$0.5 \times V_{CCO}$	—
eHSTL Class 1	1.71	1.8	1.89	0.84	0.90	0.95	—	$0.5 \times V_{CCO}$	—
LVPECL (Differential)	3.0V	3.3V	3.6V	—	—	—	—	—	—
LVDS	$V_{CCO} = 2.5V$	2.375	2.5V	2.625	—	—	—	—	—
	$V_{CCO} = 3.3V$	3.0	3.3	3.6	—	—	—	—	—

Note: '—' denotes V_{REF} or V_{TT} not applicable to this logic standard

E²CMOS Memory Write/Erase Characteristics

Parameter	Conditions	Min.	Typ.	Max.	Units
Erase/Reprogram Cycles		1000	—	—	

Performance Characteristics – Power Supply

Symbol	Parameter	Conditions	Typ.	Max.	Units
I _{CCD}	Core Supply Current ³	ispClock5610A f _{VCO} = 800MHz	110	125	mA
		ispClock5620A f _{VCO} = 800MHz	130	150	mA
I _{CCA}	Analog Supply Current ³	f _{VCO} = 800MHz	5.5	7	mA
I _{CCO}	Output Driver Supply Current (per Bank)	V _{CCO} = 1.8V ¹ , LVCMOS, f _{OUT} = 266MHz	16	18	mA
		V _{CCO} = 2.5V ¹ , LVCMOS, f _{OUT} = 266MHz	21	27	mA
		V _{CCO} = 3.3V ¹ , LVCMOS, f _{OUT} = 266MHz	27	38	mA
		V _{CCO} = 3.3V ² , LVDS, f _{OUT} = 400MHz	8	10	mA
I _{CCJ}	JTAG I/O Supply Current (static)	V _{CCJ} = 1.8V		300	μA
		V _{CCJ} = 2.5V		400	μA
		V _{CCJ} = 3.3V		400	μA

1. Supply current consumed by each bank, both outputs active, 5pF load.
2. Supply current consumed by each bank, 100Ω, 5pf differential load.
3. All unused REFCLK and feedbacks connected to ground.

DC Electrical Characteristics – Single-ended Logic

Logic Standard	V _{IL} (V)		V _{IH} (V)		V _{OL} Max. (V)	V _{OH} Min. (V)	I _{OL} (mA)	I _{OH} (mA)
	Min.	Max.	Min.	Max.				
LVTTTL/LVCMOS 3.3V	-0.3	0.8	2	3.6	0.4	V _{CCO} - 0.4	12 ^{2,3}	-12 ^{2,3}
LVCMOS 1.8V	-0.3	0.68	1.07	3.6	0.4	V _{CCO} - 0.4	12 ^{2,3}	-12 ^{2,3}
LVCMOS 2.5V	-0.3	0.7	1.7	3.6	0.4	V _{CCO} - 0.4	12 ^{2,3}	-12 ^{2,3}
SSTL2 Class 1	-0.3	V _{REF} - 0.18	V _{REF} + 0.18	3.6	0.54 ²	V _{CCO} - 0.81 ¹	7.6	-7.6
SSTL3 Class 1	-0.3	V _{REF} - 0.2	V _{REF} + 0.2	3.6	0.9 ²	V _{CCO} - 1.3 ¹	8	-8
HSTL Class 1	-0.3	V _{REF} - 0.1	V _{REF} + 0.1	3.6	0.4 ³	V _{CCO} - 0.4 ²	8	-8
eHSTL Class 1	-0.3	V _{REF} - 0.1	V _{REF} + 0.1	3.6	0.4 ³	V _{CCO} - 0.4 ²	8	-8

1. Specified for 40Ω internal series output termination.
2. Specified for ≈20Ω internal series output termination, fast slew rate setting.
3. For slower slew rate setting I_{OH}, I_{OL} = 8mA.

DC Electrical Characteristics – LVDS

Symbol	Parameter	Conditions	Min.	Typ.	Max.	Units
V _{ICM}	Common Mode Input Voltage	V _{THD} ≤ 100mV	V _{THD} /2	—	2.0	V
		V _{THD} ≤ 150mV	V _{THD} /2	—	2.325	V
V _{THD}	Differential Input Threshold		±100	—	—	mV
V _{IN}	Input Voltage		0	—	2.4	V
V _{OH}	Output High Voltage	R _T = 100Ω	—	1.375	1.60	V
V _{OL}	Output Low Voltage	R _T = 100Ω	0.9	1.03	—	V
V _{OD}	Output Voltage Differential	R _T = 100Ω	250	400	480	mV
ΔV _{OD}	Change in V _{OD} Between H and L		—	—	50	mV
V _{OS}	Output Voltage Offset	Common Mode Output Voltage	1.10	1.20	1.375	V
ΔV _{OS}	Change in V _{OS} Between H and L		—	—	50	mV
I _{SA}	Output Short Circuit Current	V _{OD} = 0V, Outputs Shorted to GND	—	—	24	mA
I _{SAB}	Output Short Circuit Current	V _{OD} = 0V, Outputs Shorted to Each Other	—	—	12	mA

DC Electrical Characteristics – Differential LVPECL

Symbol	Parameter	Test Conditions	Min.	Typ.	Max.	Units
V _{IH}	Input Voltage High	V _{CCD} = 3.0 to 3.6V	V _{CCD} - 1.17	—	V _{CCD} - 0.88	V
		V _{CCD} = 3.3V	2.14	—	2.42	
V _{IL}	Input Voltage Low	V _{CCD} = 3.0 to 3.6V	V _{CCD} - 1.81	—	V _{CCD} - 1.48	V
		V _{CCD} = 3.3V	1.49	—	1.83	
V _{OH}	Output High Voltage ¹	V _{CCO} = 3.0 to 3.6V	V _{CCO} - 1.07	—	V _{CCO} - 0.88	V
		V _{CCO} = 3.3V	2.23	—	2.42	
V _{OL}	Output Low Voltage ¹	V _{CCO} = 3.0 to 3.6V	V _{CCO} - 1.81	—	V _{CCO} - 1.62	V
		V _{CCO} = 3.3V	1.49	—	1.68	

1. 100Ω differential termination.

Electrical Characteristics – Differential SSTL18

Symbol	Parameter	Conditions	Min.	Typ.	Max.	Units
V _{CCO}	Output Supply Voltage		1.71	1.8	1.89	V
V _{IL}	Low-Logic Level Input Voltage				0.61	V
V _{IH}	Hi Logic Level Input Voltage		1.17			V
V _{SWING}	AC Differential Output Voltage		0.64			V
V _{IX}	Input Pair Differential Crosspoint Voltage		V _{REF} -175mV		V _{REF} +175mV	V
TCKD	Clock Duty Cycle	Load Conditions (Figure 1-6)	45		55	%

Electrical Characteristics – Differential SSTL2

Symbol	Parameter	Conditions	Min.	Typ.	Max.	Units
V _{CCO}	Output Supply Voltage		2.375	2.5	2.625	V
V _{SWING(DC)}	DC Differential Input Voltage Swing		-0.03		3.225	V
V _{SWING(AC)}	AC Input Differential Voltage		0.62		3.225	V
V _{IX}	Input Pair Differential Crosspoint Voltage		V _{REF} - 200 mV		V _{REF} + 200 mV	V
TCKD	Clock Duty Cycle	Load Conditions (Figure 1-6)	45		55	%

Electrical Characteristics – Differential HSTL

Symbol	Parameter	Conditions	Min	Typ	Max	Units
V _{CCO}	Output Supply Voltage		1.425	1.5	1.575	V
V _{SWING(DC)}	DC Differential Input Voltage Swing		-0.03		V _{CCD}	V
V _{SWING(AC)}	AC Input Differential Voltage		0.4		V _{CCD}	V
V _{IX}	Input Pair Differential Crosspoint Voltage		0.68		0.9	V
TCKD	Clock Duty Cycle	Load Conditions (Figure 1-6)	45		55	%

Electrical Characteristics – Differential eHSTL

Symbol	Parameter	Conditions	Min	Typ	Max	Units
V _{CCO}	Output Supply Voltage		1.7	1.8	1.9	V
V _{SWING(DC)}	DC Differential Input Voltage Swing		-0.03		V _{CCD}	V
V _{SWING(AC)}	AC Input Differential Voltage		0.4		V _{CCD}	V
V _{IX}	Input Pair Differential Crosspoint Voltage		0.68		0.9	V
TCKD	Clock Duty Cycle	Load Conditions (Figure 1-6)	45		55	%

DC Electrical Characteristics – Input/Output Loading

Symbol	Parameter	Conditions	Min.	Typ.	Max.	Units
I _{LK}	Input Leakage	Note 1	—	—	±10	µA
I _{PU}	Input Pull-up Current	Note 2	—	80	120	µA
I _{PD}	Input Pull-down Current	Note 3	—	120	150	µA
I _{OLK}	Tristate Leakage Output	Note 4	—	—	±10	µA
C _{IN}	Input Capacitance	Notes 2, 3, 5	—	8	10	pF
		Note 6	—	13.5	15	pF

1. Applies to clock reference inputs when termination 'open'.
2. Applies to TDI, TMS inputs.
3. Applies to REFSEL, PS0, PS1, \overline{GOE} , SGATE and PLL_BYPASS, FBKSEL, OEX, OEY.
4. Applies to all logic types when in tristated mode.
5. Applies to OEX, OEY, TCK, RESET inputs.
6. Applies to REFA+, REFA-, REFB+, REFB-, FBKA+, FBKA-, FBKB+, FBKB-.

Switching Characteristics – Timing Adders for I/O Modes

Adder Type	Description	Min.	Typ.	Max.	Units
t_{IOI} Input Adders²					
LVTTTL_in	Using LVTTTL Standard	0	0	0	ps
LVC MOS18_in	Using LVC MOS 1.8V Standard	-99	80	315	ps
LVC MOS25_in	Using LVC MOS 2.5V Standard	0	0	0	ps
LVC MOS33_in	Using LVC MOS 3.3V Standard	0	0	0	ps
SSTL18_in	Using SSTL18 Standard	10	360	642	ps
SSTL2_in	Using SSTL2 Standard	64	420	679	ps
SSTL3_in	Using SSTL3 Standard	34	380	630	ps
HSTL_in	Using HSTL Standard	231	672	1064	ps
eHSTL_in	Using eHSTL Standard	128	514	846	ps
LVDS_in	Using LVDS Standard	118	426	651	ps
LVPECL_in	Using LVPECL Standard	201	593	937	ps
t_{IOO} Output Adders^{1,3}					
LVTTTL_out	Output Configured as LVTTTL Buffer	116	395	553	ps
LVC MOS18_out	Output Configured as LVC MOS 1.8V Buffer	155	510	730	ps
LVC MOS25_out	Output Configured as LVC MOS 2.5V Buffer	124	387	592	ps
LVC MOS33_out	Output Configured as LVC MOS 3.3V Buffer	116	395	553	ps
SSTL2_out	Output Configured as SSTL2 Buffer	-109	66	209	ps
SSTL3_out	Output Configured as SSTL3 Buffer	-97	78	242	ps
SSTL18_out_diff	Output Configured as SSTL18 Buffer (Differential)	-153	41	228	ps
HSTL_out_diff	Output Configured as HSTL Buffer (Differential)	-4	180	402	ps
eHSTL_out_diff	Output Configured as eHSTL Buffer (Differential)	-16	173	375	ps
SSTL_out_diff	Output Configured as SSTL2 Buffer (Differential)	-146	83	305	ps
LVDS_out	Output Configured as LVDS Buffer	0	0	0	ps
LVPECL_out	Output Configured as LVPECL Buffer	-187	-17	57	ps
t_{IOS} Output Slew Rate Adders¹					
Slew_1	Output Slew_1 (Fastest)	—	0	—	ps
Slew_2	Output Slew_2	—	330	—	ps
Slew_3	Output Slew_3	—	660	—	ps
Slew_4	Output Slew_4 (Slowest)	—	1320	—	ps

1. Measured under standard output load conditions. See Figures 1-3-1-5.

2. All input adders referenced to LVC MOS33.

3. All output adders referenced to LVDS.

Output Rise and Fall Times – Typical Values^{1, 2}

Output Type	Slew 1 (Fastest)		Slew 2		Slew 3		Slew 4 (Slowest)		Units
	t _R	t _F	t _R	t _F	t _R	t _F	t _R	t _F	
LVTTTL	0.54	0.76	0.60	0.87	0.78	1.26	1.05	1.88	ns
LVC MOS 1.8V	0.75	0.69	0.88	0.78	0.83	1.11	1.20	1.68	ns
LVC MOS 2.5V	0.57	0.69	0.65	0.78	0.99	0.98	1.65	1.51	ns
LVC MOS 3.3V	0.55	0.77	0.60	0.87	0.78	1.26	1.05	1.88	ns
SSTL18	0.55	0.40	—	—	—	—	—	—	ns
SSTL2	0.50	0.40	—	—	—	—	—	—	ns
SSTL3	0.50	0.45	—	—	—	—	—	—	ns
HSTL	0.60	0.45	—	—	—	—	—	—	ns
eHSTL	0.55	0.40	—	—	—	—	—	—	ns
LVDS ³	0.25	0.20	—	—	—	—	—	—	ns
LVPECL ³	0.20	0.20	—	—	—	—	—	—	ns

1. See Figures 1-3-1-5 for test conditions.
2. Measured between 20% and 80% points.
3. Only the 'fastest' slew rate is available in LVDS and LVPECL modes.

Output Test Loads

Figures 1-3-1-5 show the equivalent termination loads used to measure rise/fall times, output timing adders and other selected parameters as noted in the various tables of this data sheet.

Figure 1-3. CMOS Termination Load

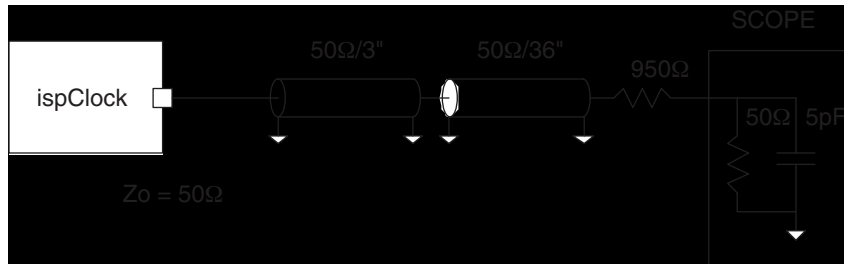

Figure 1-4. eHSTL/HSTL/SSTL Termination Load

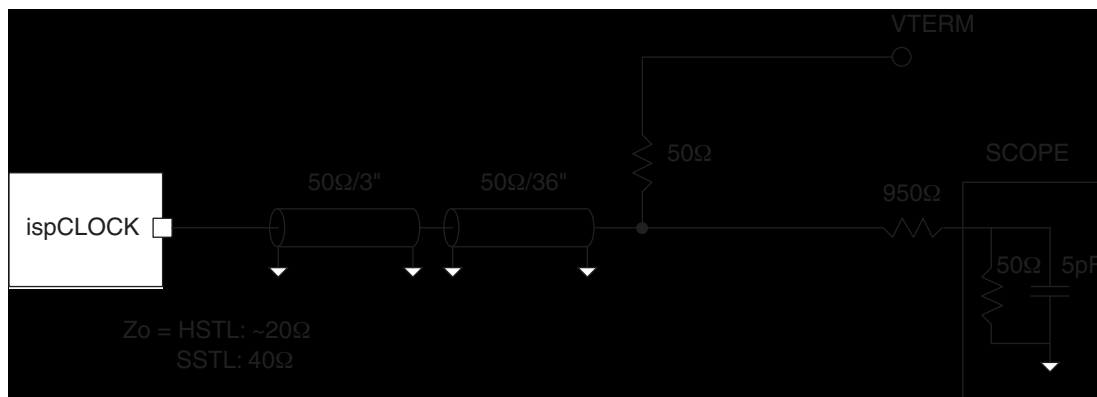

Figure 1-5. LVDS/LVPECL Termination Load

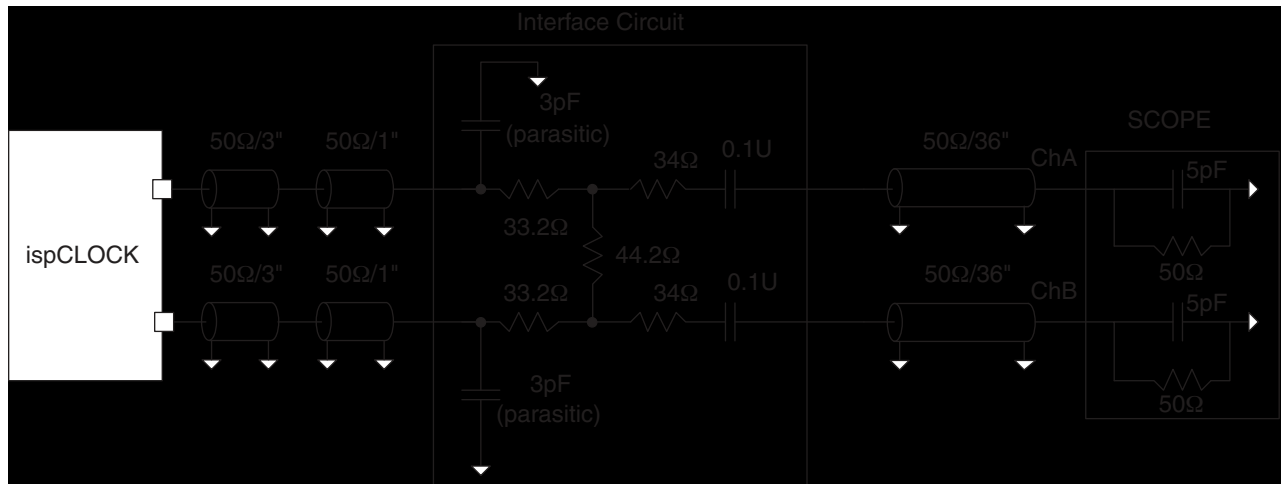
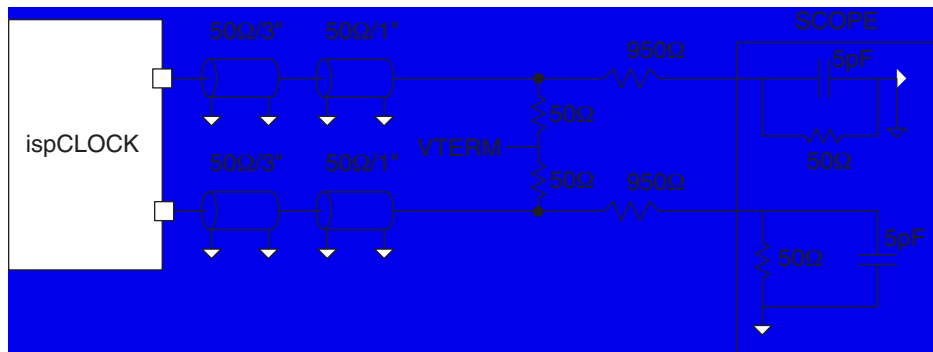

Figure 1-6. Differential HSTL/SSTL Termination Load



Programmable Input and Output Termination Characteristics

Symbol	Parameter	Conditions	V _{CCO} Voltage	Min.	Typ.	Max.	Units
R _{IN}	Input Resistance	R _{in} =40Ω setting		36	—	44	Ω
		R _{in} =45Ω setting		40.5	—	49.5	
		R _{in} =50Ω setting		45	—	55	
		R _{in} =55Ω setting		49.5	—	60.5	
		R _{in} =60Ω setting		54	—	66	
		R _{in} =65Ω setting		59	—	71.5	
		R _{in} =70Ω setting		61	—	77	
R _{OUT}	Output Resistance ¹	R _{out} ≈20Ω setting	V _{CCO} =3.3V	—	15	—	Ω
			V _{CCO} =2.5V	—	15	—	
			V _{CCO} =1.8V	—	16	—	
			V _{CCO} =1.5V	—	14	—	
		R _{out} ≈40Ω setting	V _{CCO} =3.3V	-9%	40	9%	
			V _{CCO} =2.5V	-11%	40	11%	
			V _{CCO} =1.8V	-13%	41	13%	
		R _{out} ≈45Ω setting	V _{CCO} =3.3V	-10%	45	10%	
			V _{CCO} =2.5V	-12%	45	12%	
			V _{CCO} =1.8V	-14%	48	14%	
		R _{out} ≈50Ω setting	V _{CCO} =3.3V	-8%	50	8%	
			V _{CCO} =2.5V	-9%	50	9%	
			V _{CCO} =1.8V	-13%	54	13%	
		R _{out} ≈55Ω setting	V _{CCO} =3.3V	-9%	55	9%	
			V _{CCO} =2.5V	-11%	55	11%	
			V _{CCO} =1.8V	-13%	59	13%	
		R _{out} ≈60Ω setting	V _{CCO} =3.3V	-8%	59	8%	
			V _{CCO} =2.5V	-9%	59	9%	
			V _{CCO} =1.8V	-14%	63	14%	
		R _{out} ≈65Ω setting	V _{CCO} =3.3V	-8%	65	8%	
			V _{CCO} =2.5V	-9%	64	9%	
			V _{CCO} =1.8V	-13%	69	13%	
		R _{out} ≈70Ω setting	V _{CCO} =3.3V	-9%	72	9%	
			V _{CCO} =2.5V	-10%	70	10%	
V _{CCO} =1.8V	-12%		74	12%			

1. Guaranteed by characterization.

Performance Characteristics – PLL

Symbol	Parameter	Conditions	Min.	Typ.	Max.	Units
f_{REF}, f_{FBK}	Reference and feedback input frequency range		8		400	MHz
$t_{CLOCKHI}, t_{CLOCKLO}$	Reference and feedback input clock HIGH and LOW times	M-Divider and N-Divider not bypassed.	1.25			ns
t_{RINP}, t_{FINP}	Reference and feedback input rise and fall times	Measured between 20% and 80% levels			5	ns
M_{DIV}	M-divider range		1		40	
N_{DIV}	N-Divider range		1		40	
f_{PFD}	Phase detector input frequency range ²		8		400	MHz
f_{VCO}	VCO operating frequency		320		800	MHz
V_{DIV}	Output Divider range	Even integer values only	2		80	
f_{OUT}	Output frequency range ¹	Fine Skew Mode, $f_{VCO} = 800\text{MHz}$ All differential options	4		400	MHz
		All single-ended options	4		266	MHz
		Coarse Skew Mode, $f_{VCO} = 800\text{MHz}$	2.5		200	MHz
$t_{JIT(cc)}$	Output adjacent-cycle jitter ⁶ (1000 cycle sample)	$f_{PFD} \geq 100\text{MHz}$			70	ps (p-p)
$t_{JIT(per)}$	Output period jitter ⁶ (10000 cycle sample)	$f_{PFD} \geq 100\text{MHz}$			12	ps (RMS)
$t_{JIT(\phi)}$	Reference clock to output jitter ⁶ (2000 cycle sample)	$f_{PFD} \geq 100\text{MHz}$			50	ps (RMS)
t_{ϕ}	Static phase offset ⁵		-100		200	ps
t_{DELAY}	Reference clock to output delay	Internal feedback mode ⁴		2.25		ns
DC	Output duty cycle	Output type LVCMOS 3.3V ³ $f_{OUT} > 100\text{MHz}$	45		55	%
$t_{PDBY-PASS}$	Reference clock to output propagation delay	M=1, V=2 Input: LVPECL Output: LVPECL	6.2		8.8	ns
		Input: LVCMOS Output: LVCMOS	6		8.25	ns
t_{LOCK}	PLL lock time	From Power-up event		150		μs
		From Reset event		15		μs
t_{RELOCK}	PLL relock time	To same reference frequency		15		μs
		To different frequency		150		μs
PSR	Power supply rejection, period jitter vs. power supply noise	$f_{IN} = f_{OUT} = 100\text{MHz}$ $V_{CCA} = V_{CCD} = V_{CCO}$ modulated with 100kHz sinusoidal stimulus		0.05		ps(RMS) mV(p-p)

1. In PLL Bypass mode (PLL_BYPASS = HIGH), output will support frequencies down to 0Hz (divider chain is a fully static design).

2. Dividers should be set so that they provide the phase detector with signals of 8MHz or greater for loop stability.

3. See Figures 1-3-1-5 for output loads.

4. Input and outputs LVPECL mode

5. Inserted feedback loop delay < 7ns

6. Measured with $f_{OUT} = 100\text{MHz}$, $f_{VCO} = 600\text{MHz}$, input and output interface set to LVPECL.

Timing Specifications

Skew Matching

Symbol	Parameter	Conditions	Min.	Typ.	Max.	Units
t_{SKREW}	Output-output Skew	Between any two identically configured and loaded outputs regardless of bank.	—	—	50	ps

Programmable Skew Control

Symbol	Parameter	Conditions	Min.	Typ.	Max.	Units
$t_{SKRANGE}$	Skew Control Range ¹	Fine Skew Mode, $f_{VCO} = 320$ MHz	—	5.86	—	ns
		Fine Skew Mode, $f_{VCO} = 800$ MHz	—	2.34	—	
		Coarse Skew Mode, $f_{VCO} = 320$ MHz	—	11.72	—	
		Coarse Skew Mode, $f_{VCO} = 800$ MHz	—	4.68	—	
SK_{STEPS}	Skew Steps per range		—	16	—	
t_{SKSTEP}	Skew Step Size ²	Fine Skew Mode, $f_{VCO} = 320$ MHz	—	390	—	ps
		Fine Skew Mode, $f_{VCO} = 800$ MHz	—	156	—	
		Coarse Skew Mode, $f_{VCO} = 320$ MHz	—	780	—	
		Coarse Skew Mode, $f_{VCO} = 800$ MHz	—	312	—	
t_{SKERR}	Skew Time Error ³	Fine skew mode	—	30	—	ps
		Coarse skew mode	—	50	—	

1. Skew control range is a function of VCO frequency (f_{VCO}). In fine skew mode $T_{SKRANGE} = 15/(8 \times f_{VCO})$.
In coarse skew mode $T_{SKRANGE} = 15/(4 \times f_{VCO})$.
2. Skew step size is a function of VCO frequency (f_{VCO}). In fine skew mode $T_{SKSTEP} = 1/(8 \times f_{VCO})$.
In coarse skew mode $T_{SKSTEP} = 1/(4 \times f_{VCO})$.
3. Only applicable to outputs with non-zero skew settings.

Control Functions

Symbol	Parameter	Conditions	Min.	Typ.	Max.	Units
$t_{DIS/OE}$	Delay Time, $\overline{OE}X$ or $\overline{OE}Y$ to Output Disabled/Enabled		—	10	20	ns
$t_{DIS/GOE}$	Delay Time, \overline{GOE} to Output Disabled/Enabled		—	10	20	ns
$t_{SUSGATE}$	Setup Time, SGATE to Output Clock Start/Stop		3	—	—	cycles ¹
t_{PLL_RSTW}	PLL Reset Pulse Width ²		1	—	—	ms
t_{RSTW}	Logic Reset Pulse Width ³		20	—	—	ns
t_{HPS_RST}	Hold time for RESET past change in PS[0..1]		20	—	—	ns

1. Output clock cycles for the particular output being controlled.
2. Will completely reset PLL.
3. Will only reset digital logic.

Figure 1-7. RESET and Profile Select Timing



Timing Specifications (Cont.)

Boundary Scan Logic

Symbol	Parameter	Min.	Max.	Units
t_{BTCP}	TCK (BSCAN Test) Clock Cycle	40	—	ns
t_{BTCH}	TCK (BSCAN Test) Pulse Width High	20	—	ns
t_{BTCL}	TCK (BSCAN Test) Pulse Width Low	20	—	ns
t_{BTSU}	TCK (BSCAN Test) Setup Time	8	—	ns
t_{BTH}	TCK (BSCAN Test) Hold Time	10	—	ns
t_{BRF}	TCK (BSCAN Test) Rise and Fall Rate	50	—	mV/ns
t_{BTCO}	TAP Controller Falling Edge of Clock to Valid Output	—	10	ns
t_{BTOZ}	TAP Controller Falling Edge of Clock to Data Output Disable	—	10	ns
t_{BTVO}	TAP Controller Falling Edge of Clock to Data Output Enable	—	10	ns
t_{BVTCP}	BSCAN Test Capture Register Setup Time	8	—	ns
t_{BTCPH}	BSCAN Test Capture Register Hold Time	10	—	ns
t_{BTUCO}	BSCAN Test Update Register, Falling Edge of Clock to Valid Output	—	25	ns
t_{BTUOZ}	BSCAN Test Update Register, Falling Edge of Clock to Output Disable	—	25	ns
t_{BTUOV}	BSCAN Test Update Register, Falling Edge of Clock to Output Enable	—	25	ns

JTAG Interface and Programming Mode

Symbol	Parameter	Condition	Min.	Typ.	Max.	Units
f_{MAX}	Maximum TCK Clock Frequency		—	—	25	MHz
t_{CKH}	TCK Clock Pulse Width, High		20	—	—	ns
t_{CKL}	TCK Clock Pulse Width, Low		20	—	—	ns
t_{ISPEN}	Program Enable Delay Time		15	—	—	μ s
t_{ISPDIS}	Program Disable Delay Time		30	—	—	μ s
t_{HVDIS}	High Voltage Discharge Time, Program		30	—	—	μ s
t_{HVDIS}	High Voltage Discharge Time, Erase		200	—	—	μ s
t_{CEN}	Falling Edge of TCK to TDO Active		—	—	15	ns
t_{CDIS}	Falling Edge of TCK to TDO Disable		—	—	15	ns
t_{SU1}	Setup Time		8	—	—	ns
t_H	Hold Time		10	—	—	ns
t_{CO}	Falling Edge of TCK to Valid Output		—	—	15	ns
t_{PWV}	Verify Pulse Width		30	—	—	μ s
t_{PWP}	Programming Pulse Width		20	—	—	ms
t_{BEW}	Bulk Erase Pulse Width		200	—	—	ms

Timing Diagrams

Figure 1-8. Erase (User Erase or Erase All) Timing Diagram

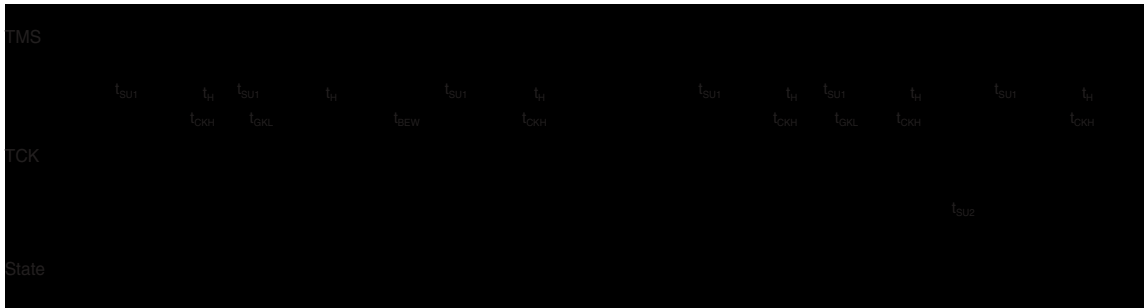

Figure 1-9. Programming Timing Diagram

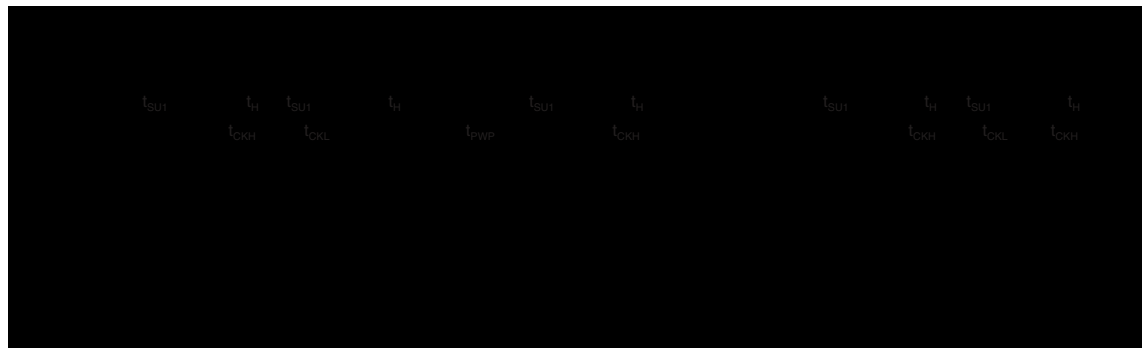

Figure 1-10. Verify Timing Diagram

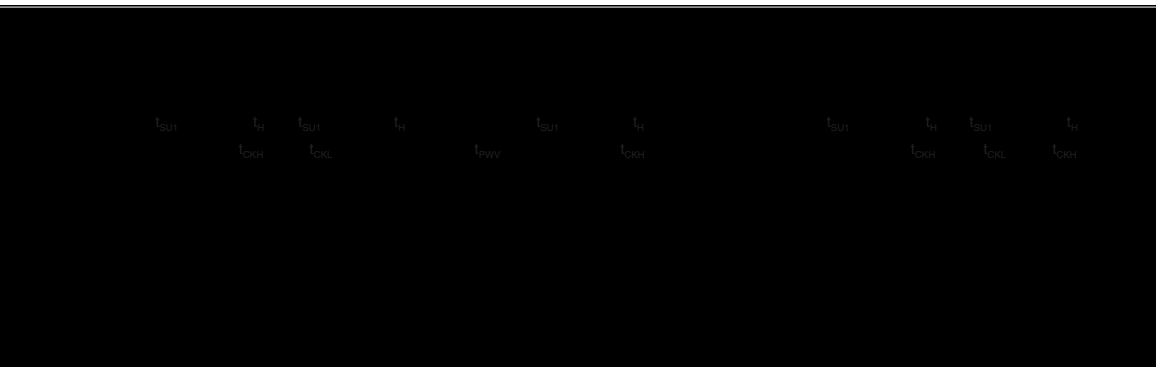
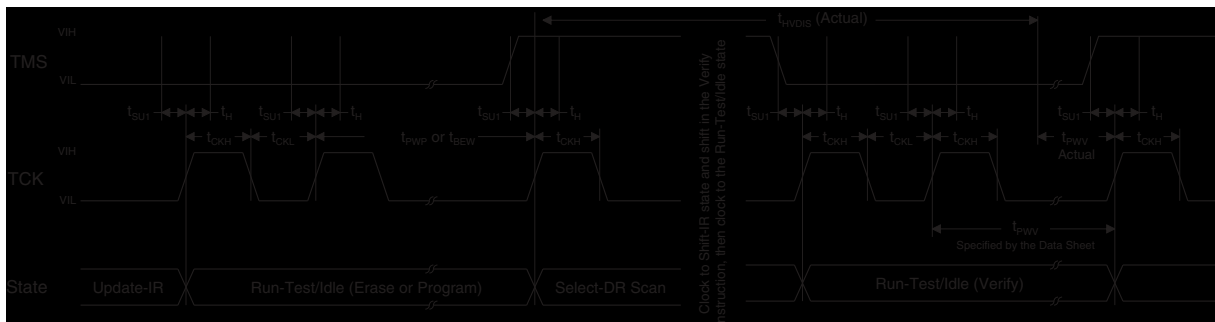
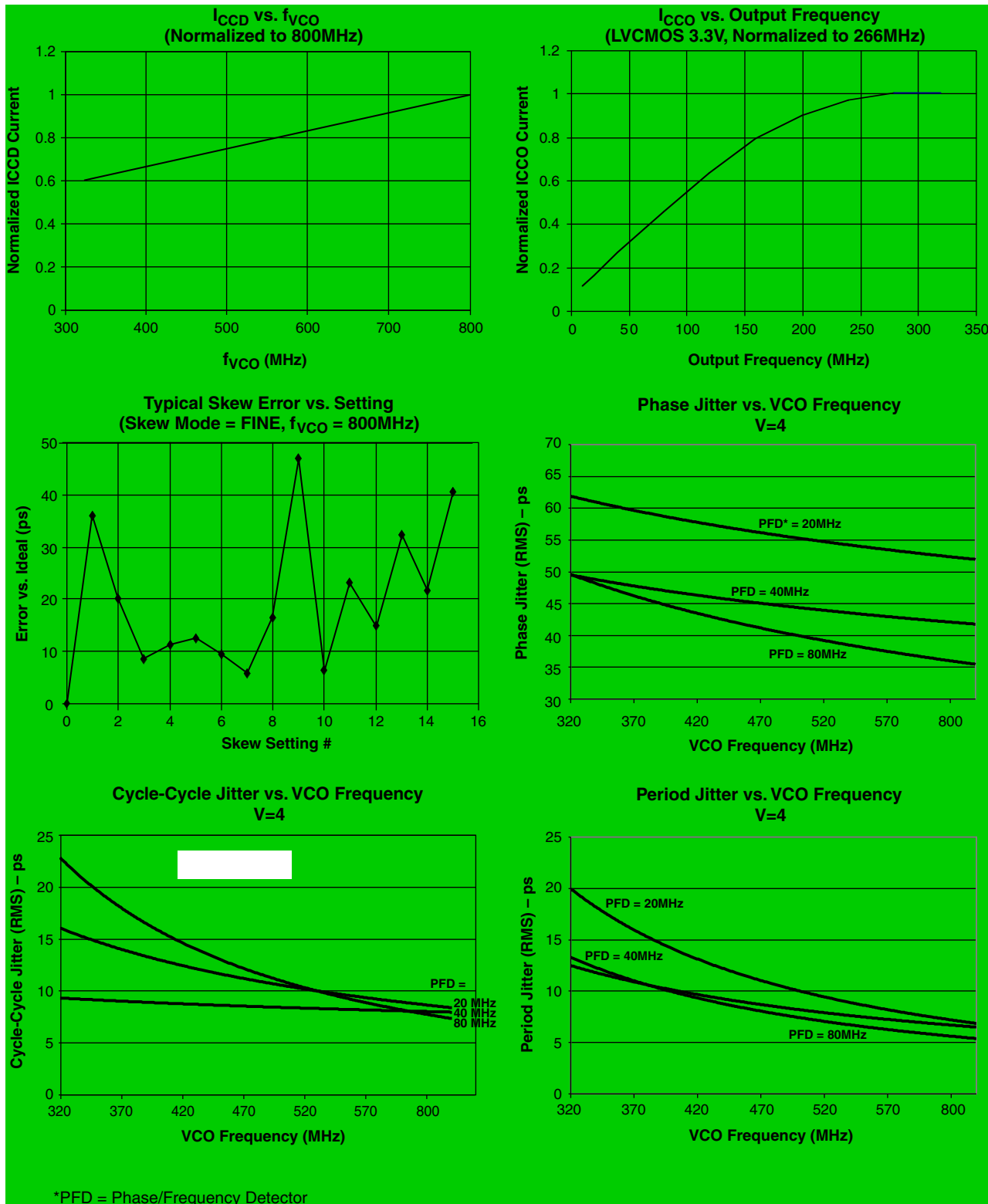

Figure 1-11. Discharge Timing Diagram



Typical Performance Characteristics



Typical Performance Characteristics (Cont.)

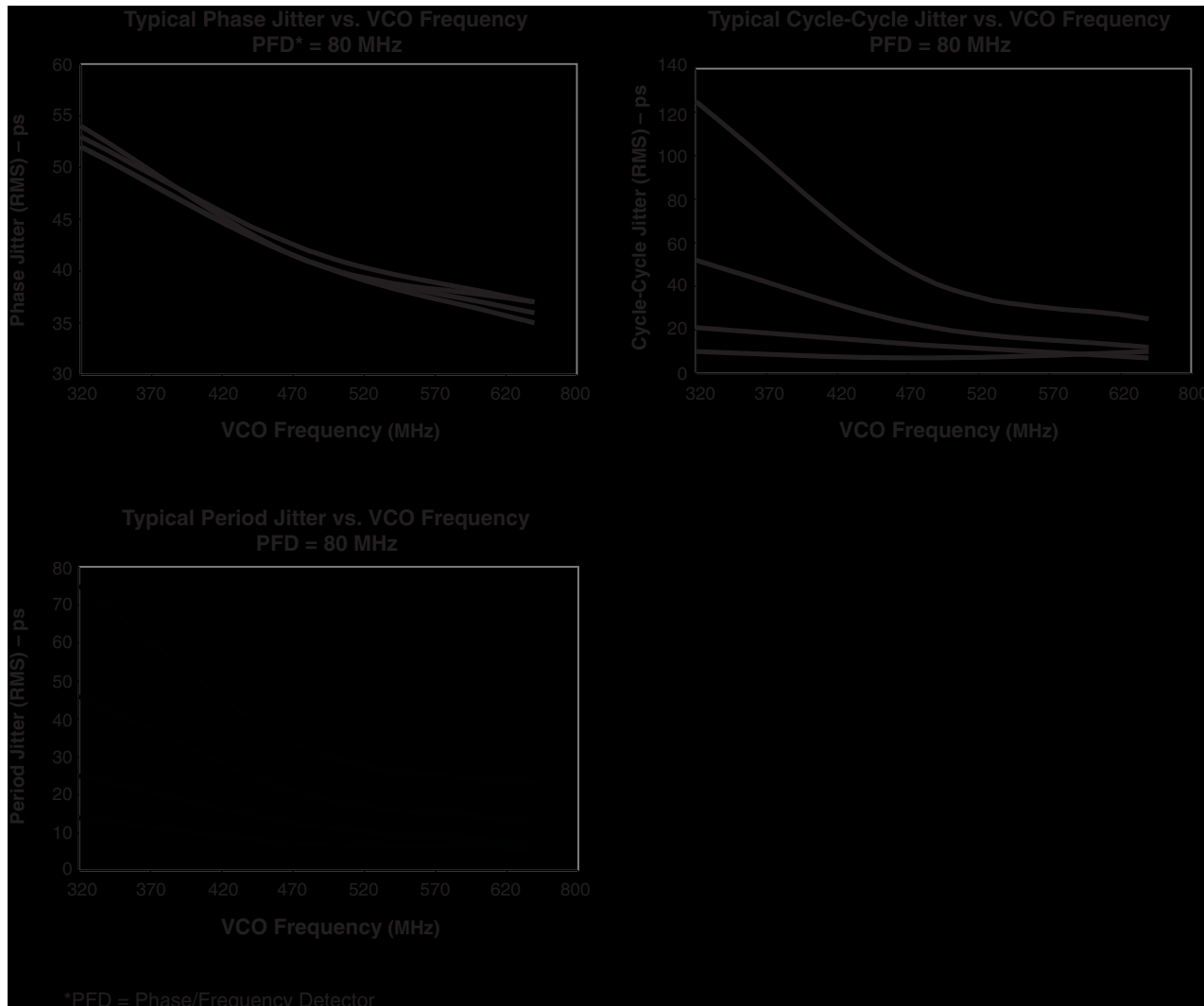

Detailed Description

PLL Subsystem

The ispClock5600A provides an integral phase-locked-loop (PLL) which may be used to generate output clock signals at lower, higher, or the same frequency as a user-supplied input reference signal. The core functions of the PLL are an edge-sensitive phase detector, a programmable loop filter, and a high-speed voltage-controlled oscillator (VCO). Additionally, a set of programmable input, output and feedback dividers (M, N, V[1..5]) is provided to support the synthesis of different output frequencies.

Phase/Frequency Detector

The ispClock5600A provides an edge-sensitive phase/frequency detector (PFD), which means that the device will function properly over a wide range of input clock reference duty cycles. It is only necessary that the input reference clock meet specified minimum HIGH and LOW times ($t_{CLOCKHI}$, $t_{CLOCKLO}$) for it to be properly recognized by the PFD. The PFD's output is of a classical charge-pump type, outputting charge packets which are then integrated by the PLL's loop filter.

A lock-detection feature is also associated with the PFD. When the ispClock5600A is in a LOCKED state, the LOCK output pin goes LOW. The lock detector has two operating modes: Phase Lock Detect mode and Frequency

Lock Detect mode. In Phase Lock Detect mode, the LOCK signal is asserted if the phases of the reference and feedback signals match, whereas in Frequency Lock Detect mode the LOCK signal is asserted when the frequencies of the feedback and reference signals match. The option for which mode to use is programmable and may be set using PAC-Designer software (available from the Lattice website at www.latticesemi.com).

In Phase Lock Detect mode the lock detector asserts the LOCK signal as soon as a lock condition is determined.

In Frequency Lock Detect mode, however, the PLL must be in a locked condition for a set number of phase detector cycles before the LOCK signal will be asserted. The number of cycles required before asserting the LOCK signal in frequency-lock mode can be set from 16 to 256.

When the lock condition is lost the LOCK signal will be de-asserted immediately in both Phase Lock Detect and Frequency Lock Detect modes.

Loop Filter: The loop filter parameters for each profile are automatically selected by the PAC-Designer software depending on the following:

- Individual profile VCO operating frequency
- Individual profile NxV product
- Maximum VCO operating frequency across all used profiles

Spread Spectrum Support: The reference clock inputs of the ispClock5600A device are spread spectrum clock tolerant. The tolerance limits are:

- Center spread $\pm 0.125\%$ to $\pm 2\%$
- Down spread -0.25% to -4%
- 30-33kHz modulation frequency

Figure 1-12. PLL Loop Bandwidth vs. Feedback Divider Setting (Nominal)

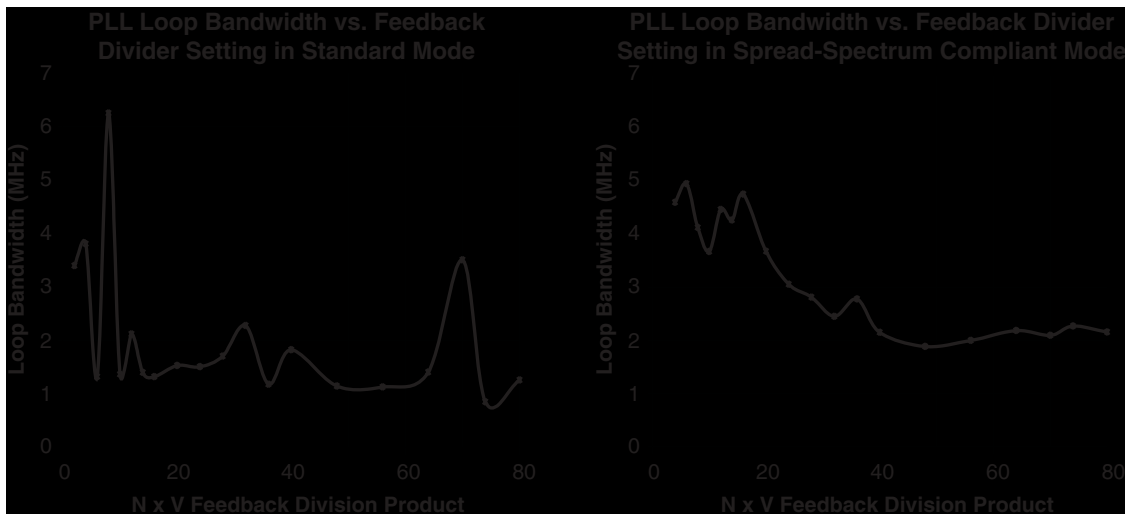

VCO

The ispClock5600A provides an internal VCO which provides an output frequency ranging from 320MHz to 800MHz. The VCO is implemented using differential circuit design techniques which minimize the influence of power supply noise on measured output jitter. The VCO is also used to generate output clock skew as a function of the total VCO period. Using the VCO as the basis for controlling output skew allows for highly precise and consistent skew generation, both from device-to-device, as well as channel-to-channel within the same device.

M-, N-, and V-Dividers

The ispClock5600A incorporates a set of programmable dividers which provide the ability to synthesize output frequencies differing from that of the reference clock input.

The input, or M-Divider prescales the input reference frequency, and can be programmed with integer values over the range of 1 to 40. To achieve low levels of output jitter, it is best to use the smallest M-Divider value possible.

The feedback, or N-Divider prescales the feedback frequency and like the M-Divider, can also be programmed with integer values ranging from 1 to 40.

Each one of the five output, or V-Dividers can be independently programmed to provide even division ratios ranging from 2 to 80.

When the PLL is selected (PLL_BYPASS=LOW) and locked, the output frequency of each V-Divider (f_k) may be calculated as:

$$f_k = f_{ref} \frac{N \times V_{fbk}}{M \times V_k} \quad (1)$$

where

f_k is the frequency of V-Divider k

f_{ref} is the input reference frequency

M and N are the input and feedback divider settings

V_{fbk} is the setting of the V-Divider used to close the PLL feedback path

V_k is the setting of the V-Divider used to provide output k

Note that because the feedback may be taken from any V-Divider, V_k and V_{fbk} may refer to the same divider.

Because the VCO has an operating frequency range spanning 320 MHz to 800 MHz, and the V-Dividers provide division ratios from 2 to 80, the ispClock5600A can generate output signals ranging from 5 MHz to 400 MHz. For performance and stability reasons, however, there are several constraints which should be followed when selecting divider values:

- Use the smallest feasible value for the M-Divider
 - The output frequency from the M (and N) divider should be greater or equal to 8 MHz.
- The product of the N-Divider and the V-Divider used to close the PLL's feedback loop should be less than or equal to 80 ($N \times V_{fbk} \leq 80$)

M-Divider and N-Divider Bypass Mode

The M-Divider and the N-Divider in the ispClock5600A device can be bypassed using PAC-Designer software. M and N-Dividers should be bypassed in applications that require glitchless switching between reference and feedback clocks. However, the frequencies of these clocks should be close. If M and N-Dividers are not bypassed, one should ensure that $t_{CLOCKHI}$ and $t_{CLOCKLO}$ specifications are not violated. Otherwise, activation of the reset signal is necessary to ensure reliable switchover.

Figure 1-13. M-Divider and N-Divider Bypass Mode

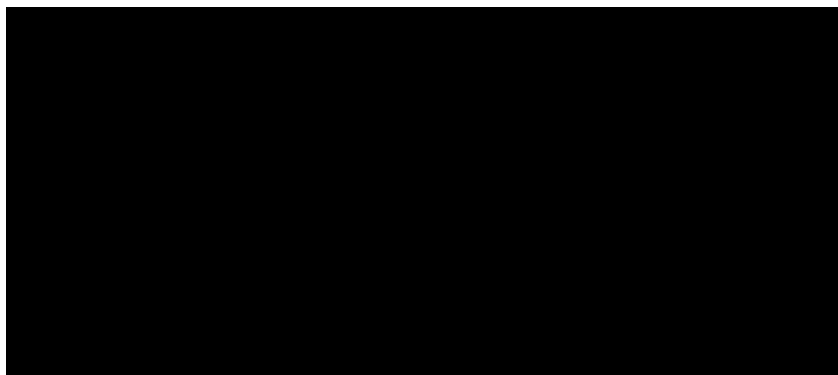

Note: Bypassing M- and N-Dividers also results in reducing the number of output frequency combinations generated from a single reference clock input.

PLL_BYPASS Mode

The PLL_BYPASS mode is provided so that input reference signals can be coupled through to the outputs without using the PLL functions. When PLL_BYPASS mode is enabled (PLL_BYPASS=HIGH), the output of the M-Divider is routed directly to the inputs of the V-Dividers. In PLL_BYPASS mode, the nominal values of the V-Dividers are halved, so that they provide division ratios ranging from 1 to 40. The output frequency for a given V-Divider (f_k) will be determined by

$$f_k = \frac{f_{ref} \times 2}{M \times V_k} \tag{2}$$

Please note that PLL_BYPASS mode is provided primarily for testing purposes. When PLL_BYPASS mode is enabled, features such as lock detect and skew generation are unavailable.

Reference and External Feedback Inputs

The ispClock5600A provides sets of configurable, internally-terminated inputs for both clock reference and feedback signals. In normal operation, one of the clock reference input pairs (REFA+/- or REFB+/-) is used as a clock input.

The external feedback inputs make it possible to compensate for input to output delay through external means. This makes it possible to provide output clocks which have very low skews in relation to the reference clock regardless of loading effects.

The ispClock5610A provides one input signal pair for reference input and one input pair for external feedback, while the ispClock5620A provides two pairs for reference signals and two pairs for feedback. To select between reference and feedback inputs, the ispClock5620A provides two CMOS-compatible digital inputs called REFSEL and FBKSEL. Table 1-2 shows the behavior of these two control inputs.

Table 1-2. REFSEL and FBKSEL Operation for ispClock5620A

REFSEL	Selected Input Pair	FBKSEL	Selected Input Pair
0	REFA+/-	0	FBKA+/-
1	REFB+/-	1	FBKB+/-

- LVTTTL (3.3V)
- LVCMOS (1.8V, 2.5V, 3.3V)
- SSTL2
- SSTL3
- HSTL
- eHSTL
- Differential SSTL1.8
- Differential SSTL2
- Differential SSTL3
- Differential HSTL
- LVDS
- LVPECL (differential, 3.3V)

Each input also features internal programmable termination resistors, as shown in Figure 1-14. Note that all reference inputs (REFA+, REFA-, REFB+, REFB-) terminate to the REFVTT pin, while all feedback inputs (FBKA+, FBKA-, FBKB+, FBKB-) terminate to the FBKVTT pin.

Figure 1-14. ispClock5600A Clock Reference and Feedback Input Structure (REFA+/- Pair Shown)

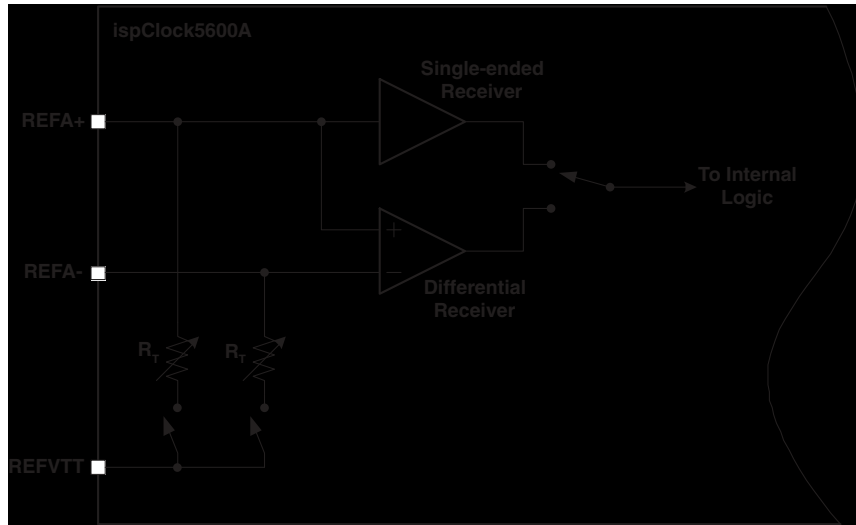

The following usage guidelines are suggested for interfacing to supported logic families.

LVTTTL (3.3V), LVCMOS (1.8V, 2.5V, 3.3V)

The receiver should be set to LVCMOS or LVTTTL mode, and the input signal should be connected to the '+' terminal of the input pair (e.g. REFA+). The '-' input terminal should be connected to GND. In addition, REFVTT should also be tied to GND. CMOS transmission lines are generally source terminated, so all termination resistors should be set to the OPEN state. Figure 1-15 shows the proper configuration. Please note that because switching thresholds are different for LVCMOS running at 1.8V, there is a separate configuration setting for this particular standard.

Figure 1-15. LVCMOS/LVTTTL Input Receiver Configuration

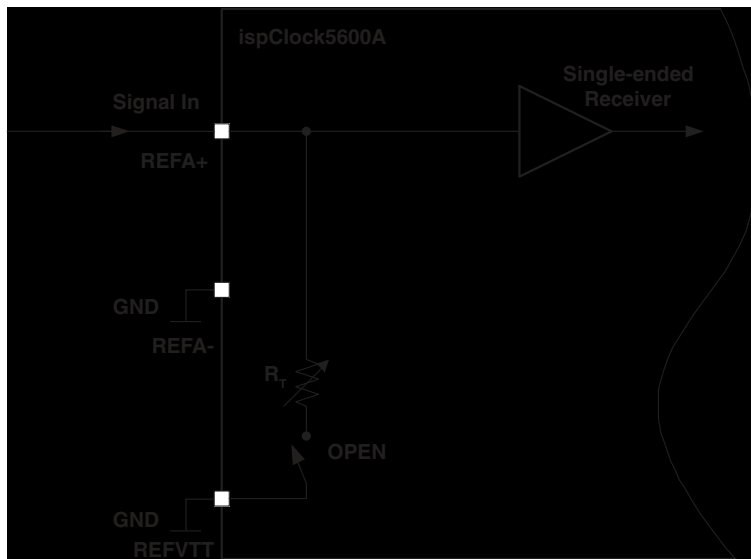

HSTL, eHSTL, SSTL2, SSTL3

The receiver should be set to HSTL/SSTL mode, and the input signal should be fed into the '+' terminal of the input pair. The '-' input terminal should be tied to the appropriate V_{REF} value, and the associated REFVTT or FBKVTT terminal should be tied to a V_{TT} termination supply. The positive input's terminating resistor should be engaged and set to 50Ω. Figure 1-16 shows an appropriate configuration. Refer to the "Recommended Operating Conditions - Supported Logic Standards" table in this data sheet for suitable values of V_{REF} and V_{TT} . If one of the REF or FBK

pairs is not used, tie the unused pins REF+ and REF- to GND. In addition, if external feedback is not used, tied FBVTT to GND.

One important point to note is that the termination supplies must have low impedance and be able to both source and sink current without experiencing fluctuations. These requirements generally preclude the use of a resistive divider network, which has an impedance comparable to the resistors used, or of commodity-type linear voltage regulators, which can only source current. The best way to develop the necessary termination voltages is with a regulator specifically designed for this purpose. Because SSTL and HSTL logic is commonly used for high-performance memory busses, a suitable termination voltage supply is often already available in the system.

Figure 1-16. SSTL2, SSTL3, eHSTL, HSTL Receiver Configuration

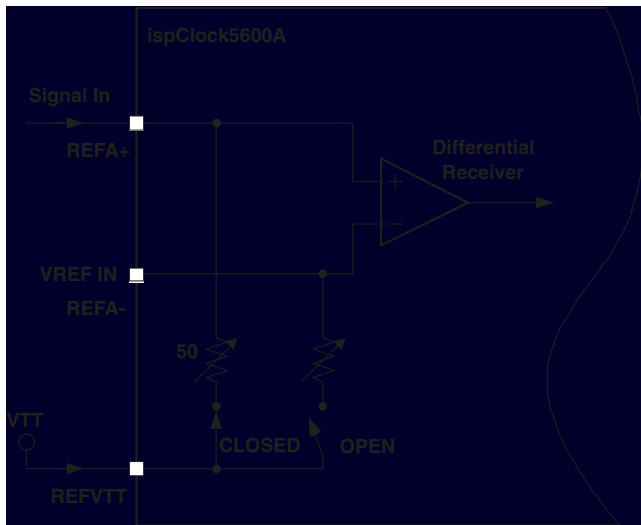

Differential HSTL and SSTL

HSTL and SSTL are sometimes used in a differential form, especially for distributing clocks in high-speed memory systems. Figure 1-17 shows how ispClock5600A reference input should be configured for accepting these standards. The major difference between differential and single-ended forms of these logic standards is that in the differential case, the REFA- input is used as a signal input, not a reference level, and that both terminating resistors are engaged and set to 50Ω. If one of the REF or FBK pairs is not used, tie the unused REF+ and REF- pins to GND. If external feedback is not used, tie FBVTT to GND as well.

Figure 1-17. Differential HSTL/SSTL Receiver Configuration

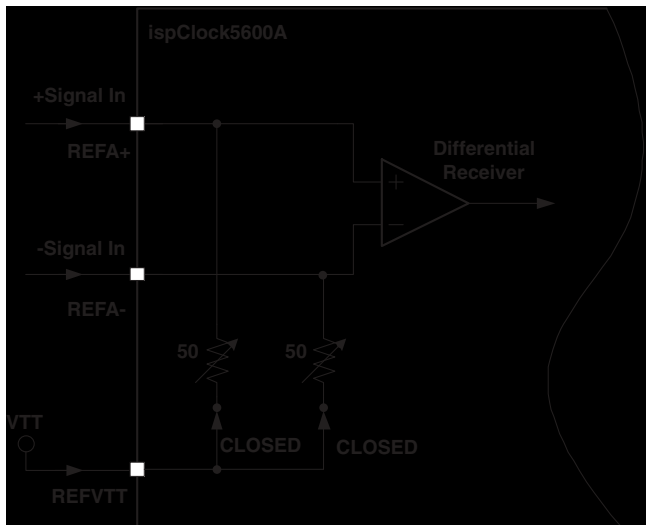

LVDS/Differential LVPECL

The receiver should be set to LVDS or LVPECL mode as required and both termination resistors should be engaged and set to 50Ω. The associated REFVTT or FBKVTT pin, however, should be left unconnected. This creates a floating 100Ω differential termination resistance across the input terminals. The LVDS termination configuration is shown in Figure 1-18.

Figure 1-18. LVDS Input Receiver Configuration

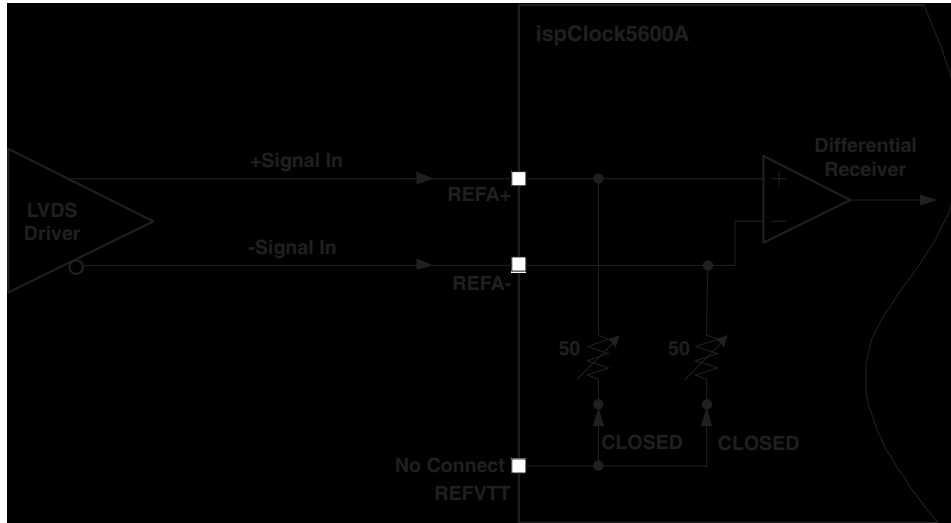

Note that while a floating 100Ω resistor forms a complete termination for an LVDS signal line, additional circuitry may be required to satisfactorily terminate a differential LVPECL signal. This is because a true bipolar LVPECL output driver typically requires an external DC ‘pull-down’ path to a V_{TERM} termination voltage (typically $V_{CC}-2V$) to properly bias its open emitter output stage. When interfacing to an LVPECL input signal, the ispClock5600A’s internal termination resistors should not be used for this pull-down function, as they may be damaged from excessive current. The pull-down should be implemented with external resistors placed close to the LVPECL driver (Figure 1-19)

Figure 1-19. LVPECL Input Receiver Configuration

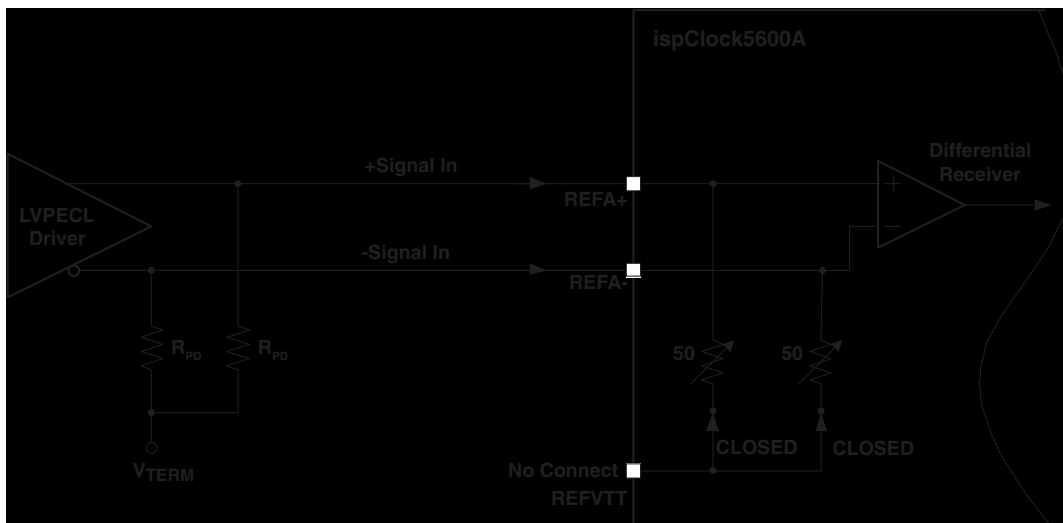

Please note that while the above discussions specify using 50Ω termination impedances, the actual impedance required to properly terminate the transmission line and maintain good signal integrity may vary from this ideal. The

actual impedance required will be a function of the driver used to generate the signal and the transmission medium used (PCB traces, connectors and cabling). The ispClock5600A's ability to adjust input impedance over a range of 40Ω to 70Ω allows the user to adapt his circuit to non-ideal behaviors from the rest of the system without having to swap out components.

Output Drivers

The ispClock5600A provide banks of configurable, internally-terminated high-speed dual-output line drivers. The ispClock5610A provides five driver banks, while the ispClock5620A provides ten. Each of these driver banks may be configured to provide either a single differential output signal, or a pair of single-ended output signals. Programmable internal source-series termination allows the ispClock5600A to be matched to transmission lines with impedances ranging from 40 to 70 Ohms. The outputs may be independently enabled or disabled, either from E²CMOS configuration or by external control lines. Additionally, each can be independently programmed to provide a fixed amount of signal delay or skew, allowing the user to compensate for the effects of unequal PCB trace lengths or loading effects. Figure 1-20 shows a block diagram of a typical ispClock5600A output driver bank and associated skew control.

Because of the high edge rates which can be generated by the ispClock5600A's clock output drivers, the VCCO power supply pin for each output bank should be individually bypassed. Low ESR capacitors with values ranging from 0.01 to 0.1 μF may be used for this purpose. Each bypass capacitor should be placed as close to its respective output bank power pins (VCCO and GNDO) pins as is possible to minimize interconnect length and associated parasitic inductances.

In the case where an output bank is unused, the associated VCCO pin may be either left floating or tied to ground to reduce quiescent power consumption. We recommend, however, that all unused VCCO pins be tied to ground where possible. All GNDO pins must be tied to ground, regardless of whether or not the associated bank is used.

Figure 1-20. ispClock5600A Output Driver and Skew Control

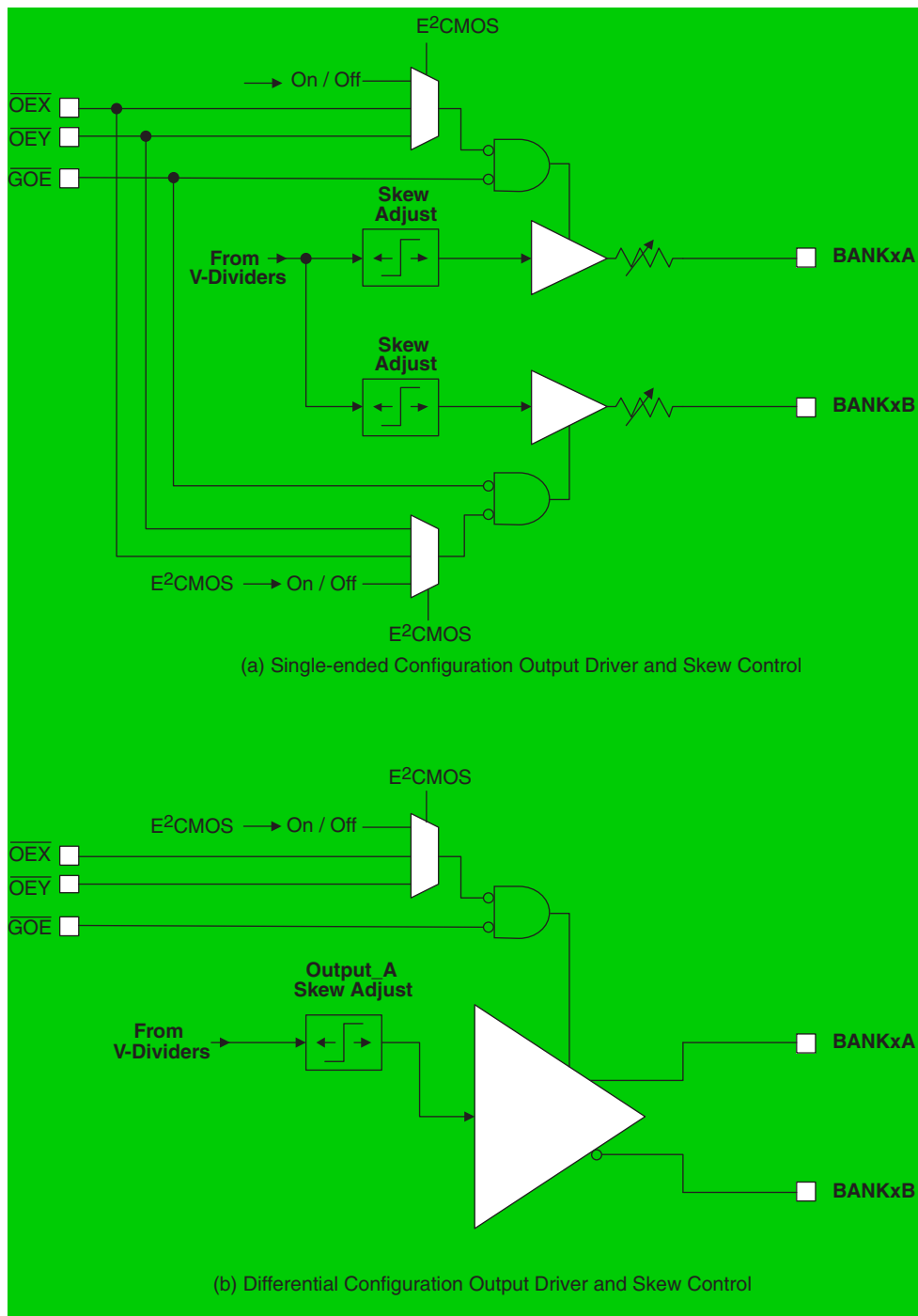

Each of the ispClock5600A's output driver banks can be configured to support the following logic outputs:

- LVTTTL
- LVCMOS (1.8V, 2.5V, 3.3V)
- SSTL2
- SSTL3
- HSTL
- eHSTL
- LVDS
- Differential LVPECL (3.3V)
- Differential SSTL18, SSTL2, SSTL3, HSTL, eHSTL

To provide LVTTTL, LVCMOS, SSTL2, SSTL3, HSTL and eHSTL outputs, the CMOS output drivers in each bank are enabled. These circuits provide logic outputs which swing from ground to the VCCO supply rail. The choice of VCCO to be supplied to a given bank is determined by the logic standard to which that bank is configured. Because each pair of outputs has its own VCCO supply pin, each bank can be independently configured to support a different logic standard. Note that the two outputs associated with a bank must necessarily be configured to the same logic standard. The source impedance of each of the two outputs in each bank may be independently set over a range of 40Ω to 70Ω in 5Ω steps. A low impedance option (≈20Ω) is also provided for cases where low source termination is desired on a given output.

Control of output slew rate is also provided in LVTTTL, LVCMOS, SSTL2, SSTL3, HSTL and eHSTL output modes. Four output slew-rate settings are provided, as specified in the "Output Rise Times" and "Output Fall Times" tables in this data sheet.

To provide LVDS and differential LVPECL outputs, a separate internal driver is used which provides the correct LVDS or LVPECL logic levels when operating from a 3.3V VCCO. Because both LVDS and differential LVPECL transmission lines are normally terminated with a single 100Ω resistor between the '+' and '-' signal lines at the far end, the ispClock5600A's internal termination resistors are not available in these modes. Also note that output slew-rate control is not available in LVDS or LVPECL mode, and that these drivers always operate at a fixed slew-rate.

Polarity control (true/inverted) is available for all output drivers. In the case of single-ended output standards, the polarity of each of the two output signals from each bank may be controlled independently. In the case of differential output standards, the polarity of the differential pair may be selected.

Suggested Usage

Figure 1-21 shows a typical configuration for the ispClock5600A's output driver when configured to drive an LVTTTL or LVCMOS load. The ispClock5600A's output impedance should be set to match the characteristic impedance of the transmission line being driven. The far end of the transmission line should be left open, with no termination resistors.

Figure 1-21. Configuration for LVTTTL/LVCMOS Output Modes

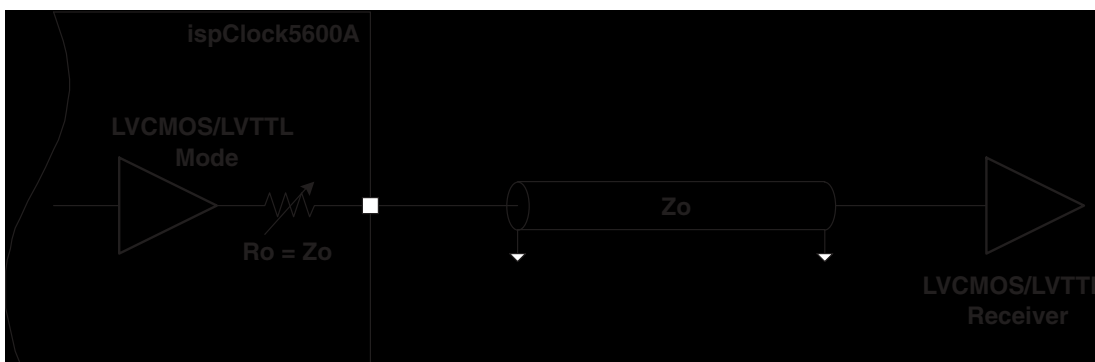

Figure 1-22 shows a typical configuration for the ispClock5600A's output driver when configured to drive SSTL2, SSTL3, HSTL or eHSTL loads. The ispClock5600A's output impedance should be set to 40Ω for driving SSTL2 or SSTL3 loads and to the $\approx 20\Omega$ setting for driving HSTL and eHSTL. The far end of the transmission line must be terminated to an appropriate VTT voltage through a 50Ω resistor.

Figure 1-22. Configuration for SSTL2, SSTL3, and HSTL Output Modes

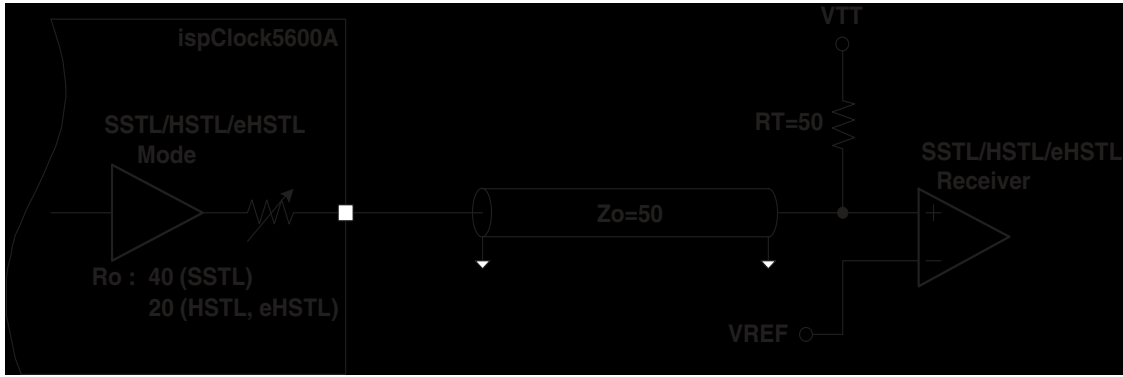
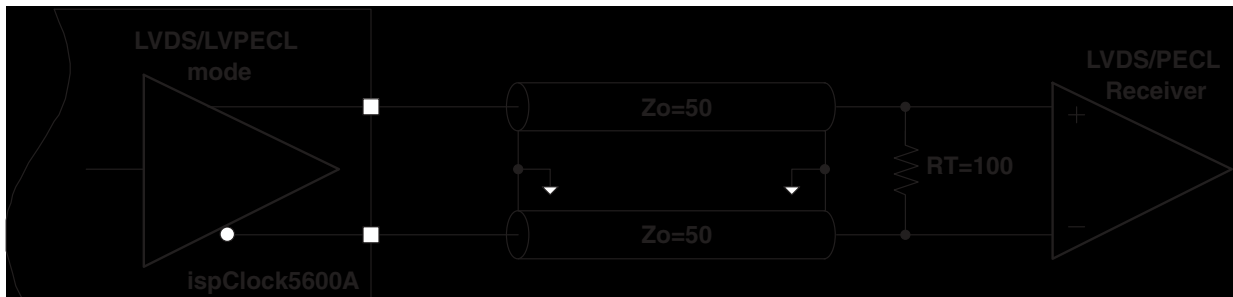

Figure 1-23 shows a typical configuration for the ispClock5600A's output driver when configured to drive LVDS or differential LVPECL loads. The ispClock5600A's output impedance is disengaged when the driver is set to LVDS or LVPECL mode. The far end of the transmission line must be terminated with a 100Ω resistor across the two signal lines.

Figure 1-23. Configuration for LVDS and LVPECL Output Modes



Note that when in LVPECL output mode, the ispClock5600A's output driver provides an internal pull-down, unlike a typical bipolar LVPECL driver. For this reason no external pull-down resistors are necessary and the driver may be terminated with a single 100Ω resistor across the signal lines. For proper operation, pull-down resistors should NOT be used with the ispClock5600A's LVPECL output mode.

Output Enable Controls

The ispClock5600A family provides the user with several options for enabling and disabling output pins, as well as suspending the output clock. In addition to providing the user with the ability to reduce the device's power consumption by turning off unused drivers, these features can also be used for functional testing purposes. The following input pins are used for output enable functions:

- \overline{GOE} – global output enable
- \overline{OEX} , \overline{OEY} – secondary output enable controls
- SGATE – synchronous output control

Additionally, internal E²CMOS configuration bits are provided for the purpose of modifying the effects of these external control pins.

When \overline{GOE} is HIGH, all output drivers are forced into a high-Z state, regardless of any internal configuration. When \overline{GOE} is LOW, the output drivers may also be enabled or disabled on an individual basis, and optionally controlled by the \overline{OEX} and \overline{OEY} pins. Internal E²CMOS configuration is used to establish whether the output driver is always enabled (when \overline{GOE} pin is LOW), never enabled (permanently off), or selectively enabled by the state of either \overline{OEX} or \overline{OEY} .

Synchronous output gating is provided by ispClock5600A devices through the use of the SGATE pin. The SGATE pin does not disable the output driver, but merely forces the output to either a high or low state, depending on the output driver's polarity setting. If the output driver polarity is true, the output will be forced LOW when SGATE is brought LOW, while if it is inverted, the output will be forced HIGH. A primary feature of the SGATE function is that the clock output is enabled and disabled synchronous to the selected internal clock source. This prevents the generation of partial, 'runt', output clock pulses, which would otherwise occur with simple combinatorial gating schemes. The SGATE is available to all clock outputs and is selectable on a bank-by-bank basis.

Table 1-3 shows the behavior of the outputs for various combinations of the output enables, SGATE input, and E²CMOS configuration.

Table 1-3. Clock Output Enable Functions

\overline{GOE}	\overline{OEX}	\overline{OEY}	E ² Configuration	Output
X	X	X	Always OFF	High-Z
0	X	X	Always ON	Clock Out
0	0	X	Enable on OEX	Clock Out
0	1	X	Enable on OEX	High-Z
0	X	0	Enable on OEY	Clock Out
0	X	1	Enable on OEY	High-Z
1	X	X	n/a	High-Z

Table 1-4. SGATE Function

SGATE	Bank Controlled by SGATE?	Output Polarity	Output
X	NO	True	Clock
X	NO	Inverted	Inverted Clock
0	YES	True	LOW
0	YES	Inverted	HIGH
1	YES	True	Clock
1	YES	Inverted	Inverted Clock

Skew Control Units

Each of the ispClock5600A's clock outputs is supported by a skew control unit which allows the user to insert an individually programmable delay into each output signal. This feature is useful when it is necessary to de-skew clock signals to compensate for physical length variations among different PCB clock paths.

Unlike the skew adjustment features provided in many competing products, the ispClock5600A's skew adjustment feature provides exact and repeatable delays which exhibit extremely low channel-to-channel and device-to-device variation. This is achieved by deriving all skew timing from the VCO, which results in the skew increment being a linear function of the VCO period. For this reason, skews are defined in terms of 'unit delays', which may be programmed by the user over a range of 0 to 15. The ispClock5600A family also supports both 'fine' and 'coarse' skew modes. In fine skew mode, the unit skew ranges from 156ps to 390 ps, while in the coarse skew mode unit skew varies from 312ps to 780ps. The exact unit skew (TU) may be calculated from the VCO frequency (f_{VCO}) by using the following expressions:

For fine skew mode, $TU = \frac{1}{8f_{VCO}}$	For coarse skew mode, $TU = \frac{1}{4f_{VCO}}$	(5)
--	--	-----

When an output driver is programmed to support a differential output mode, a single skew setting is applied to both the BANKxA+ and BANKxB- signals. When the output driver is configured to support a single-ended output standard, each of the two single-ended outputs may be assigned independent skews.

By using the internal feedback path, and programming a skew into the feedback skew control, it is possible to implement negative timing skews, in which the clock edge of interest appears at the ispClock5600A's output before the corresponding edge is presented at the reference input. When the feedback skew unit is used in this way, the resulting negative skew is added to whatever skew is specified for each output. For example, if the feedback skew is set to 6TU, BANK1's skew is 8TU and BANK2's skew is 3TU, then BANK1's effective output skew will be 2TU (8TU-6TU), while BANK2's effective skew will be -3TU (3TU-6TU). This negative skew will manifest itself as BANK2's outputs appearing to lead the input reference clock, appearing as a negative propagation delay.

Please note that the skew control units are only usable when the PLL is selected. In PLL bypass mode (PLL_BYPASS=1), output skew settings will be ineffective and all outputs will exhibit skew consistent with the device's propagation delay and the individual delays inherent in the output drivers consistent with the logic standard selected.

Coarse Skew Mode

The ispClock5600A family provides the user with the option of obtaining longer skew delays at the cost of reduced time resolution through the use of coarse skew mode. Coarse skew mode provides unit delays ranging from 312ps ($f_{VCO} = 800\text{MHz}$) to 780ps ($f_{VCO} = 320\text{MHz}$), which is twice as long as those provided in fine skew mode. When coarse skew mode is selected, an additional divide-by-2 stage is effectively inserted between the VCO and the V-divider bank, as shown in Figure 1-24. When assigning divider settings in coarse skew mode, one must account for this additional divide-by-two so that the VCO still operates within its specified range (320-800MHz).

Figure 1-24. Additional Factor-of-2 Division in Coarse Mode

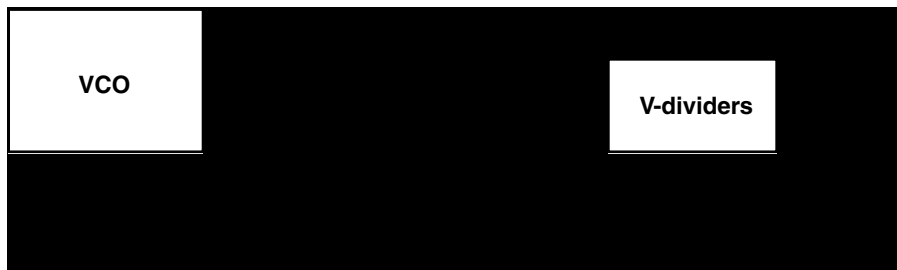

When one moves from fine skew mode to coarse skew mode with a giveN-Divider configuration, the VCO frequency will attempt to double to compensate for the additional divide-by-2 stage. Because the f_{VCO} range is not increased, however, one must modify the feedback path V-divider settings to bring f_{VCO} back into its specified operating range (320MHz to 800MHz). This can be accomplished by dividing all V-divider settings by two. All output frequencies will remain unchanged from what they were in fine mode. One drawback of moving from fine skew mode into coarse skew mode is that it may not be possible to maintain consistent output frequencies, as only those V-divider settings which are multiples of four (in fine mode) may be divided by two. For example, a V-divider setting of 24 will divide down to 12, which is also a legal V-divider setting, whereas an initial setting of 26 would divide down to 13, which is not a valid setting.

When one moves from coarse skew mode to fine skew mode, the extra divide-by-two factor is removed from between the VCO and the V-divider bank, halving the VCO's effective operating frequency. To compensate for this change, all of the V-dividers must be doubled to move the VCO back into its specified operating range and maintain consistent output frequencies. The only situation in which this may be a problem is when a V-divider initially in

coarse mode has a value greater than 40, as the corresponding fine skew mode setting would be greater than 80, which is not supported.

Output Skew Matching and Accuracy

Understanding the various factors which relate to output skew is essential for realizing optimal skew performance in the ispClock5600A family of devices.

In the case where two outputs are identically configured, and driving identical loads, the maximum skew is defined by t_{SKEW} , which is specified as a maximum of 50ps. In Figure 1-25 the Bank1A and BANK2A outputs show the skew error between two matched outputs.

Figure 1-25. Skew Matching Error Sources

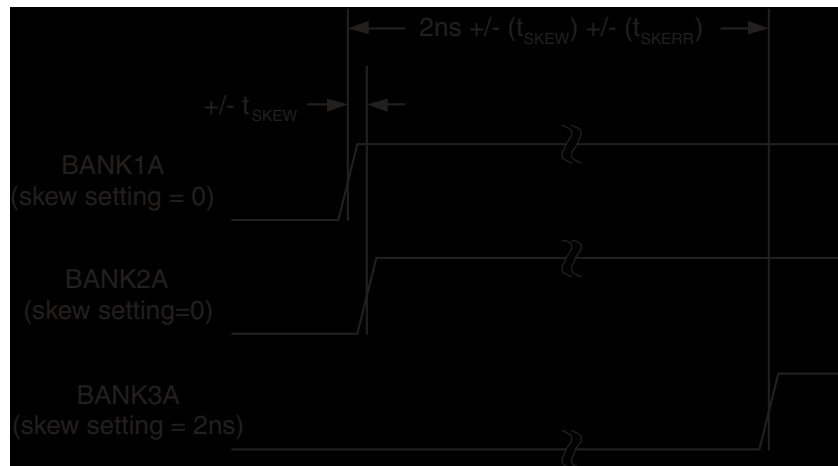

One can also program a user-defined skew between two outputs using the skew control units. Because the programmable skew is derived from the VCO frequency, as described in the previous section, the absolute skew is very accurate. The typical error for any non-zero skew setting is given by the t_{SKERR} specification. For example, if one is in fine skew mode with a VCO frequency of 500MHz, and selects a skew of 8TU, the realized skew will be 2ns, which will typically be accurate to within ± 30 ps. An example of error vs. skew setting can be found in the chart 'Typical Skew Error vs. Setting' in the typical performance characteristics section. Note that this parameter adds to output-to-output skew error only if the two outputs have *different* skew settings. The Bank1A and Bank3A outputs in Figure 1-25 show how the various sources of skew error stack up in this case. Note that if two or more outputs are programmed to the same skew setting, then the contribution of the t_{SKERR} skew error term does not apply.

When outputs are configured or loaded differently, this also has an effect on skew matching. If an output is set to support a different logic type, this can be accounted for by using the t_{IOO} output adders specified in the Table 'Switching Characteristics'. That table specifies the additional skew added to an output using LVDS as a baseline. For instance, if one output is specified as LVTTTL ($t_{\text{IOO}} = 0.395\text{ns}$), and another output is specified as LVDS ($t_{\text{IOO}} = 0\text{ns}$), then one could expect 0.395ns of additional skew between the two outputs. This timing relationship is shown in Figure 1-26a.

Figure 1-26. Output Timing Adders for Logic Type (a) and Output Slew Rate (b)

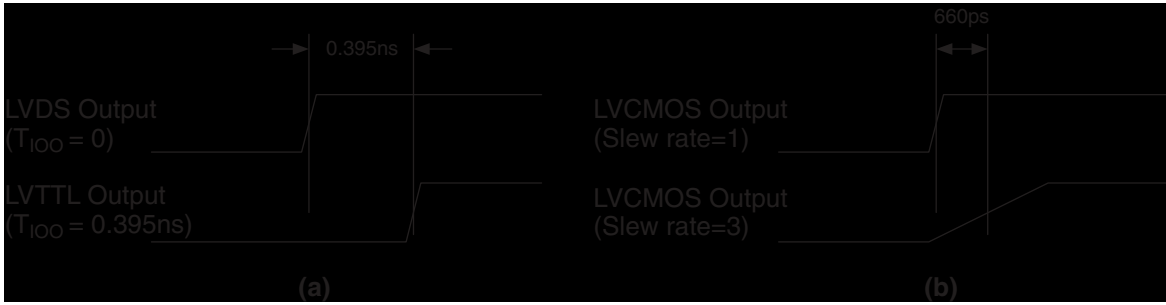

Similarly, when one changes the slew rate of an output, the output slew rate adders (t_{IOS}) can be used to predict the resulting skew. In this case, the fastest slew setting (1) is used as the baseline against which other slews are measured. For example, in the case of outputs configured to the same logic type (e.g. LVCMOS 1.8V), if one output is set to the fastest slew rate (1, $t_{IOS} = 0ps$), and another set to slew rate 3 ($t_{IOS} = 660ps$), then one could expect 660ps of skew between the two outputs, as shown in Figure 1-26b.

Static Phase Offset and Input-Output Skew

The ispClock5600A’s external feedback inputs can be used to obtain near-zero effective delays from the clock reference input pins to a designated output pin. In external feedback mode (Figure 1-27) the PLL will attempt to force the output phase so that the rising edge phase (t_{ϕ}) at the feedback input matches the rising edge phase at the reference input. The residual error between the two is specified as the static phase error. Note that any propagation delays (t_{FBK}) in the external feedback path drive the phase of the output signal *backwards* in time as measured at the output. For this reason, if zero input-to-output delays are required in external feedback mode, the length of the signal path between the output pin and the feedback pin should be minimized.

Figure 1-27. External Feedback Mode and Timing Relationships (Input, Output and Feedback Use the Same Logic Standard)

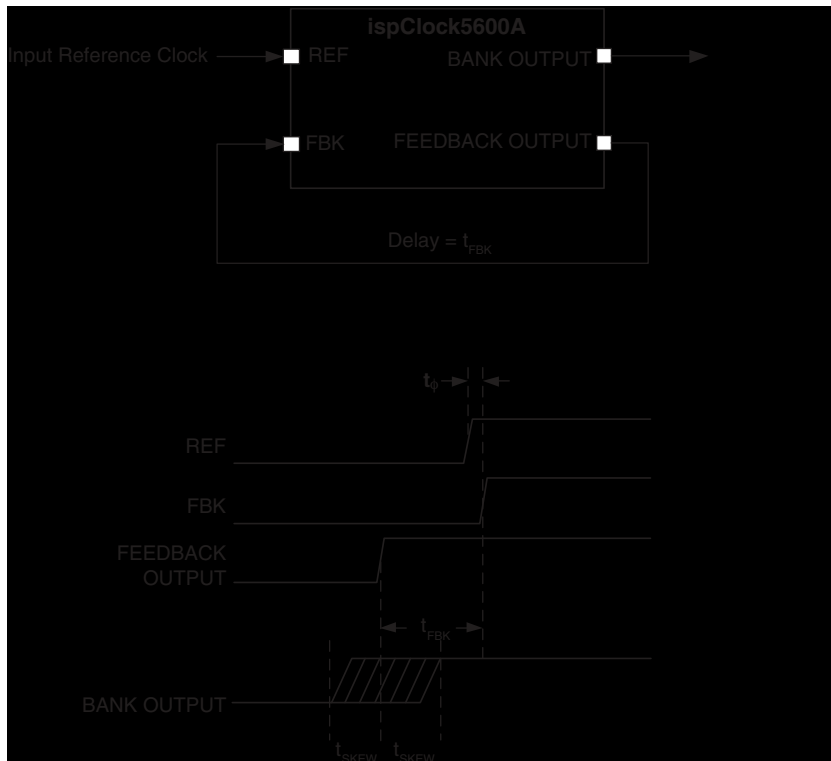

Internal Feedback Mode

In addition to supporting the use of external feedback to close the phase-locked loop, ispClock5620A also provides the option of using an internal feedback path for this function. This feature is useful for minimizing external connections and routing in situations where one can attempt to compensate for external signal path delays using the programmable skew feature of the internal feedback path.

Profile Select

The ispClock5600A stores all internal configuration data in on-board E²C MOS memory. Up to four independent configuration profiles may be stored in each device. The choice of which configuration profile is to be active is specified through the profile select inputs PS0 and PS1, as shown in Table 1-5.

Table 1-5. Profile Select Function

PS1	PS0	Active Profile
0	0	Profile 0
0	1	Profile 1
1	0	Profile 2
1	1	Profile 3

Each profile controls the following internal configuration items:

- M-Divider setting
- N-Divider setting
- V-Divider settings
- Output skew settings
- Internal feedback skew settings
- Internal vs. external feedback selection

The following settings are independent of the selection of active profile and will apply regardless of which profile is selected:

- Input logic configuration
 - Logic family
 - Input impedance
- Output bank logic configuration
 - Logic family
 - V-divider signal source
 - Enable/SGATE control options
 - Output impedance
 - Slew rate
 - Signal inversion
- V-divider to be used as feedback source
- Fine/Coarse skew mode selection
- UES string

If any of the above items are modified, the change will apply across all profiles. In some cases this may cause unanticipated behavior. If multiple profiles are used in a design, the suitability of the profile independent settings must be considered with respect to each of the individual profiles.

When a profile is changed by modifying the values of the PS0 and PS1 inputs, it is necessary to assert a RESET signal to the ispClock5600A to restart the PLL and resynchronize all the internal dividers.

RESET and Power-up Functions

To ensure proper PLL startup and synchronization of outputs, the ispClock5600A provides both internally generated and user-controllable external reset signals. An internal reset is generated whenever the device is powered up. An external reset may be applied by asserting a logic HIGH at the RESET pin. Asserting RESET resets all internal dividers, and will cause the PLL to lose lock. On losing lock, the VCO frequency will begin dropping. The length of time required to regain lock is related to the length of time for which RESET was asserted.

When the ispClock5600A begins operating from initial power-on, the VCO starts running at a very low frequency (<100 MHz) which gradually increases as it approaches a locked condition. To prevent invalid outputs from being applied to the rest of the system, it is recommended that either the SGATE, $\overline{\text{OEX}}$, or $\overline{\text{OEY}}$ pins be used to control the outputs based on the status of the LOCK pin. Holding the SGATE pin LOW during power-up will result in the BANK outputs being asserted HIGH or LOW (depending on inversion status) until SGATE is brought HIGH. Asserting $\overline{\text{OEX}}$ or $\overline{\text{OEY}}$ high will result in the BANK outputs being held in a high-impedance state until the $\overline{\text{OEX}}$ or $\overline{\text{OEY}}$ pin is pulled LOW.

When either of the minimum t_{CLOCKHI} or t_{CLOCKLO} specifications is violated, the RESET pin should be activated to insure proper behavior of the PLL and outputs.

Thermal Management

In applications where a majority of the ispClock5610A or ispClock5620A's outputs are active and operating at or near maximum output frequency (266MHz for single ended and 400MHz for differential outputs), package thermal limitations may need to be considered to ensure a successful design. Thermal characteristics of the packages employed by Lattice Semiconductor may be found in the document *Thermal Management* which may be obtained at www.latticesemi.com.

The maximum current consumption of the digital and analog core circuitry for ispClock5620A is 150mA worst case ($I_{\text{CCD}} + I_{\text{CCA}}$), and each of the output banks may draw up to 38mA worst case (LVCMOS 3.3V, $CL=5\text{pF}$, $f_{\text{OUT}}=266\text{MHz}$, both outputs in each bank enabled). This results in a total device dissipation:

$$P_{\text{DMAX}} = 3.3\text{V} \times (10 \times 38\text{mA} + 150\text{mA}) = 1.75\text{W} \quad (3)$$

With a maximum recommended operating junction temperature (T_{JOP}) of 130°C for an industrial grade device, the maximum allowable ambient temperature (T_{AMAX}) can be estimated as

$$T_{\text{AMAX}} = T_{\text{JOP}} - P_{\text{DMAX}} \times \Theta_{\text{JA}} = 130^\circ\text{C} - 1.75\text{W} \times 36.9^\circ\text{C/W} = 65.4^\circ\text{C} \quad (4)$$

where $\Theta_{\text{JA}} = 36.9^\circ\text{C/W}$ for the 100 TQFP package. $\Theta_{\text{JA}} = 68^\circ\text{C/W}$ for the 48 TQFP package in still air.

The above analysis represents the worst-case scenario. Significant improvement in maximum ambient operating temperature can be realized with additional cooling. Providing a 200 LFM (Linear Feet per Minute) airflow reduces Θ_{JA} to 33°C/W for the 100 TQFP package, which results in a maximum ambient operating temperature of 71°C.

In practice, however, the absolute worst-case situation will be relatively rare, as not all outputs may be running at maximum output frequency in a given application. Additionally, if the internal VCO is operating at less than its maximum frequency (800MHz), it requires less current on the VCCD pin. In these situations, one can estimate the effective I_{CCO} for each bank and the effective I_{CCD} for the digital core functions based on output frequency and VCO frequency. Normalized curves relating current to operating frequency for these parameters may be found in the Typical Performance Characteristics section.

While it is possible to perform detailed calculations to estimate the maximum ambient operating temperature from operating conditions, some simpler rule-of-thumb guidance can also be obtained through the derating curves shown in Figure 1-28. The curves in Figure 1-28a show the maximum ambient operating temperature permitted when operating a given number of output banks at the maximum output frequency (266MHz for single ended and 400MHz for differential outputs). Note that it is assumed that both outputs in each bank are active.

Figure 1-28. Maximum Ambient Temperature vs. Number of Active Output Banks

Figure 1-28b shows another derating curve, derived under the assumption that the output frequency is 100MHz. For many applications, 100MHz outputs will be a more realistic scenario. Comparing the maximum temperature limits of Figure 1-28b with Figure 1-28a, one can see that significantly higher operating temperatures are possible in LVCMOS 3.3V output mode with more outputs at 100MHz than at 400MHz.

The examples above used LVCMOS 3.3V logic, which represents the maximum power dissipation case at higher frequencies. For optimal operation at very high frequencies (> 150 MHz) LVDS/LVPECL will often be the best choice from a signal integrity standpoint. For LVDS-configured outputs, the maximum ICCO current consumption per bank is low enough that both the ispClock5610A and ispClock5620A can operate all outputs at maximum frequency over their complete rated temperature range, as shown in Figure 1-28c.

Note that because of variations in circuit board mounting, construction, and layout, as well as convective and forced airflow present in a given design, actual die operating temperature is subject to considerable variation from that which may be theoretically predicted from package characteristics and device power dissipation.

Software-Based Design Environment

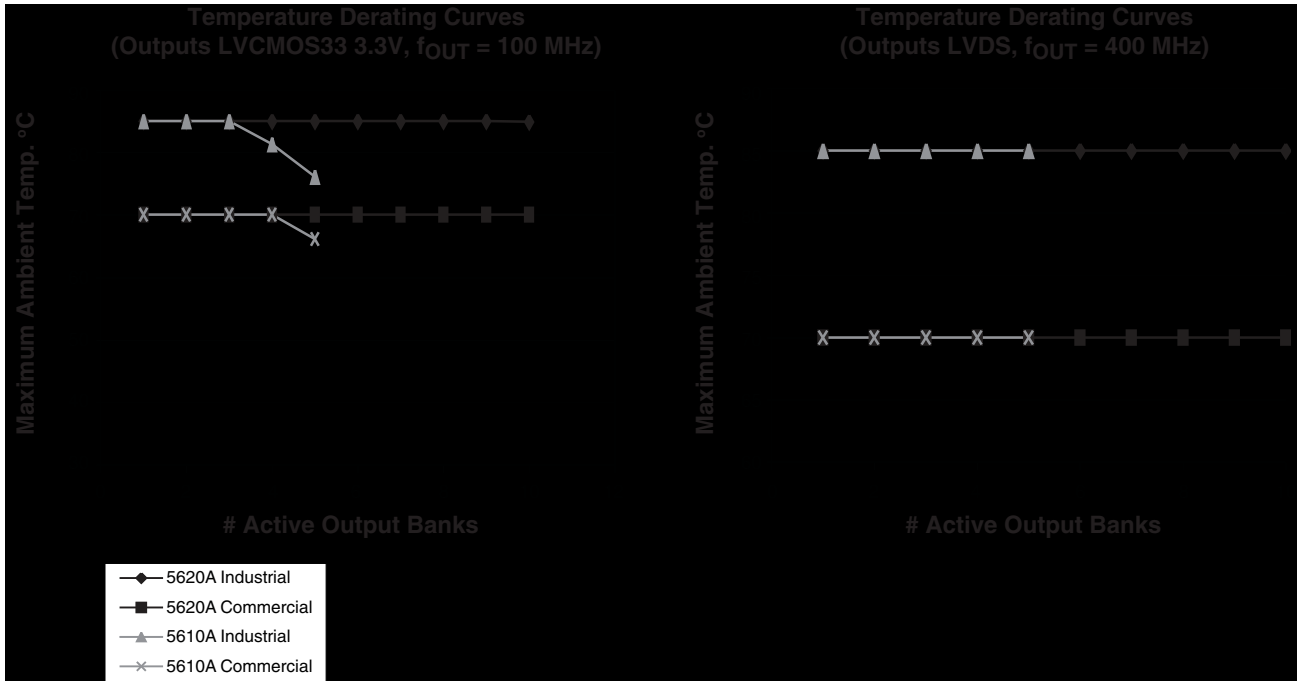
Designers can configure the ispClock5600A using Lattice's PAC-Designer software, an easy to use, Microsoft Windows compatible program. Circuit designs are entered graphically and then verified, all within the PAC-Designer environment. Full device programming is supported using PC parallel port I/O operations and a download cable connected to the serial programming interface pins of the ispClock5600A. A library of configurations is included with basic solutions and examples of advanced circuit techniques are available. In addition, comprehensive on-line and printed documentation is provided that covers all aspects of PAC-Designer operation. PAC-Designer is available for download from the Lattice website at www.latticesemi.com. The PAC-Designer schematic window, shown in Figure 1-29 provides access to all configurable ispClock5600A elements via its graphical user interface. All analog input and output pins are represented. Static or non-configurable pins such as power, ground and the serial digital interface are omitted for clarity. Any element in the schematic window can be accessed via mouse operations as well as menu commands. When completed, configurations can be saved and downloaded to devices.

Figure 1-29. PAC-Designer Design Entry Screen

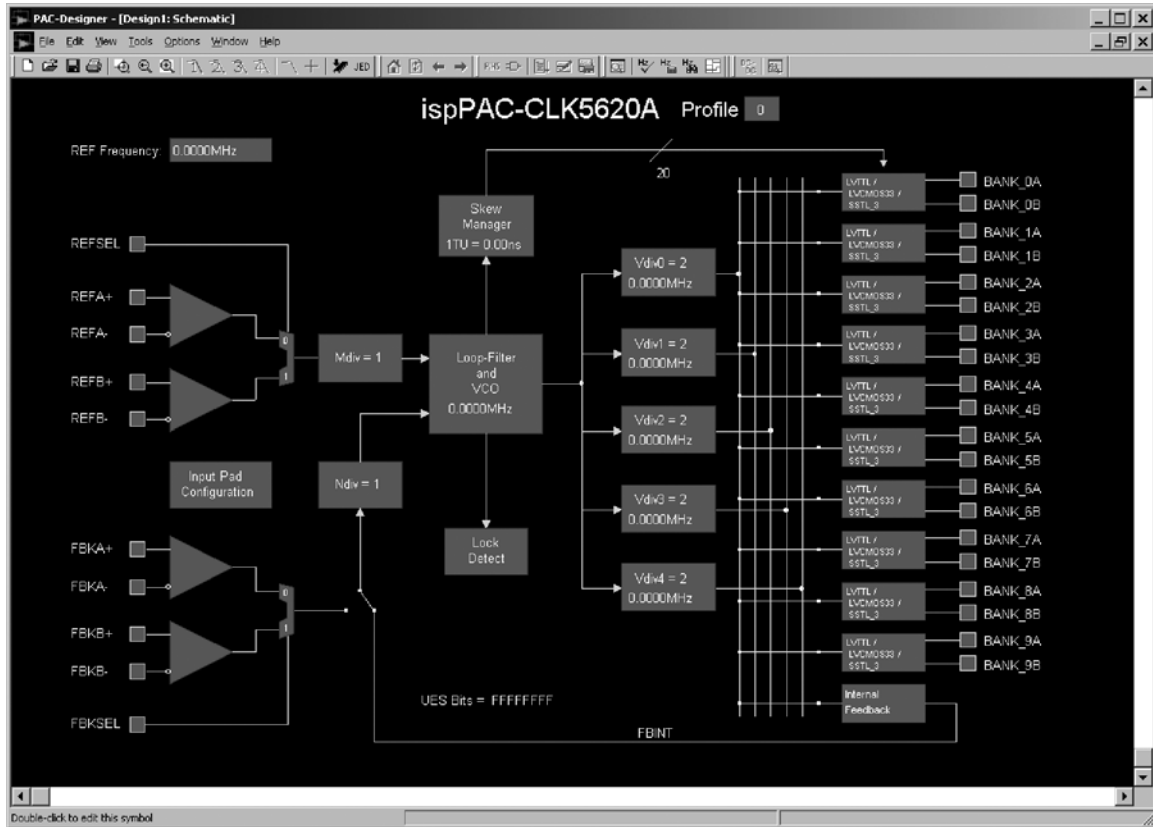

In-System Programming

The ispClock5600A is an In-System Programmable (ISP™) device. This is accomplished by integrating all E²CMOS configuration control logic on-chip. Programming is performed through a 4-wire, IEEE 1149.1 compliant serial JTAG interface at normal logic levels. Once a device is programmed, all configuration information is stored on-chip, in non-volatile E²CMOS memory cells. The specifics of the IEEE 1149.1 serial interface and all ispClock5600A instructions are described in the JTAG interface section of this data sheet.

User Electronic Signature

A user electronic signature (UES) feature is included in the E²CMOS memory of the ispClock5600A. This consists of 32 bits that can be configured by the user to store unique data such as ID codes, revision numbers or inventory control data. The specifics of this feature are discussed in the IEEE 1149.1 serial interface section of this data sheet.

Electronic Security

An electronic security “fuse” (ESF) bit is provided in every ispClock5600A device to prevent unauthorized readout of the E²CMOS configuration bit patterns. Once programmed, this cell prevents further access to the functional user bits in the device. This cell can only be erased by reprogramming the device, so the original configuration can not be examined once programmed. Usage of this feature is optional. The specifics of this feature are discussed in the IEEE 1149.1 serial interface section of this data sheet.

Production Programming Support

Once a final configuration is determined, an ASCII format JEDEC file can be created using the PAC-Designer software. Devices can then be ordered through the usual supply channels with the user’s specific configuration already preloaded into the devices. By virtue of its standard interface, compatibility is maintained with existing production programming equipment, giving customers a wide degree of freedom and flexibility in production planning.

Evaluation Fixture

Included in the basic ispClock5600A Design Kit is an engineering prototype board that can be connected to the parallel port of a PC using a Lattice ispDOWNLOAD[®] cable. It demonstrates proper layout techniques for the ispClock5600A and can be used in real time to check circuit operation as part of the design process. Input and output connections (SMA connectors for all RF signals) are provided to aid in the evaluation of the ispClock5600A for a given application. (Figure 1-30).

Part Number	Description
PAC-SYSTEMCLK5620A	Complete system kit, evaluation board, ispDOWNLOAD cable and software.
PACCLK5620A-EV	Evaluation board only, with components, fully assembled.

Figure 1-30. Download from a PC

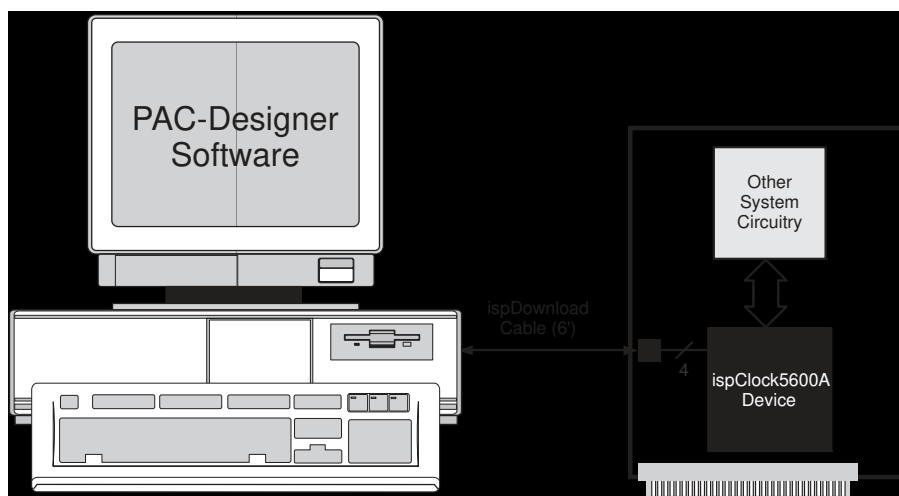

IEEE Standard 1149.1 Interface (JTAG)

Serial Port Programming Interface Communication with the ispClock5600A is facilitated via an IEEE 1149.1 test access port (TAP). It is used by the ispClock5600A both as a serial programming interface, and for boundary scan test purposes. A brief description of the ispClock5600A JTAG interface follows. For complete details of the reference specification, refer to the publication, Standard Test Access Port and Boundary-Scan Architecture, IEEE Std. 1149.1-1990 (which now includes IEEE Std. 1149.1a-1993).

Overview

An IEEE 1149.1 test access port (TAP) provides the control interface for serially accessing the digital I/O of the ispClock5600A. The TAP controller is a state machine driven with mode and clock inputs. Given in the correct sequence, instructions are shifted into an instruction register which then determines subsequent data input, data output, and related operations. Device programming is performed by addressing the configuration register, shifting data in, and then executing a program configuration instruction, after which the data is transferred to internal E²CMOS cells. It is these non-volatile cells that store the configuration of the ispClock5600A. A set of instructions are defined that access all data registers and perform other internal control operations. For compatibility between compliant devices, two data registers are mandated by the IEEE 1149.1 specification. Others are functionally specified, but inclusion is strictly optional. Finally, there are provisions for optional data registers defined by the manufacturer. The two required registers are the bypass and boundary-scan registers. Figure 1-31 shows how the instruction and various data registers are organized in an ispClock5600A.

Figure 1-31. ispClock5600A TAP Registers

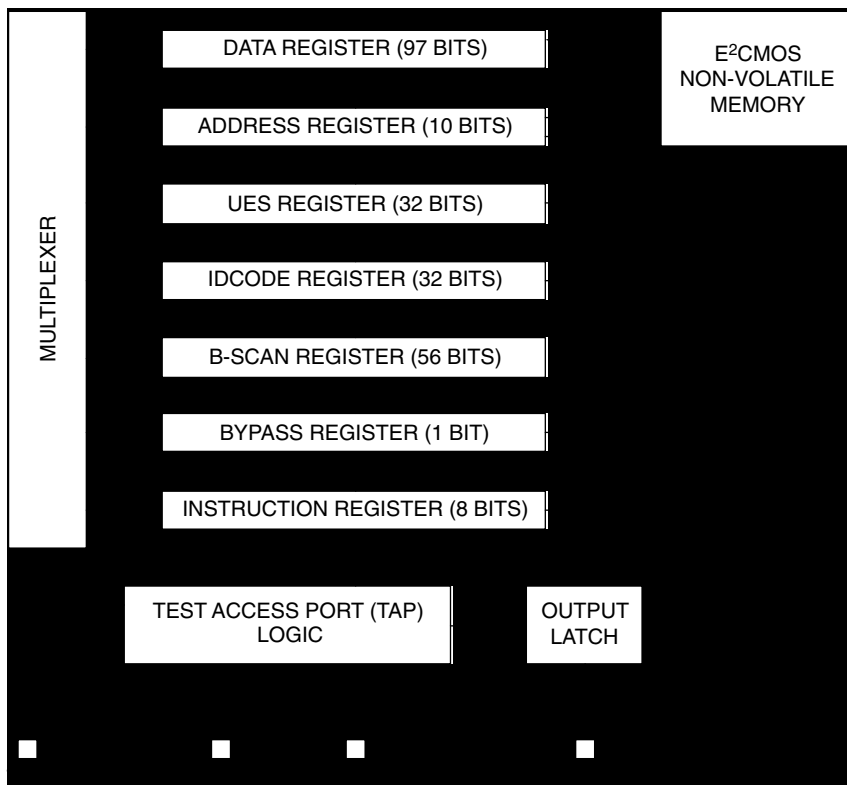

TAP Controller Specifics

The TAP is controlled by the Test Clock (TCK) and Test Mode Select (TMS) inputs. These inputs determine whether an Instruction Register or Data Register operation is performed. Driven by the TCK input, the TAP consists of a small 16-state controller design. In a given state, the controller responds according to the level on the TMS input as shown in Figure 1-32. Test Data In (TDI) and TMS are latched on the rising edge of TCK, with Test Data Out (TDO) becoming valid on the falling edge of TCK. There are six steady states within the controller: Test-Logic-Reset, Run-Test/Idle, Shift-Data-Register, Pause-Data-Register, Shift-Instruction-Register and Pause-Instruction-Register. But there is only one steady state for the condition when TMS is set high: the Test-Logic-Reset state. This allows a reset of the test logic within five TCKs or less by keeping the TMS input high. Test-Logic-Reset is the power-on default state.

Figure 1-32. TAP States

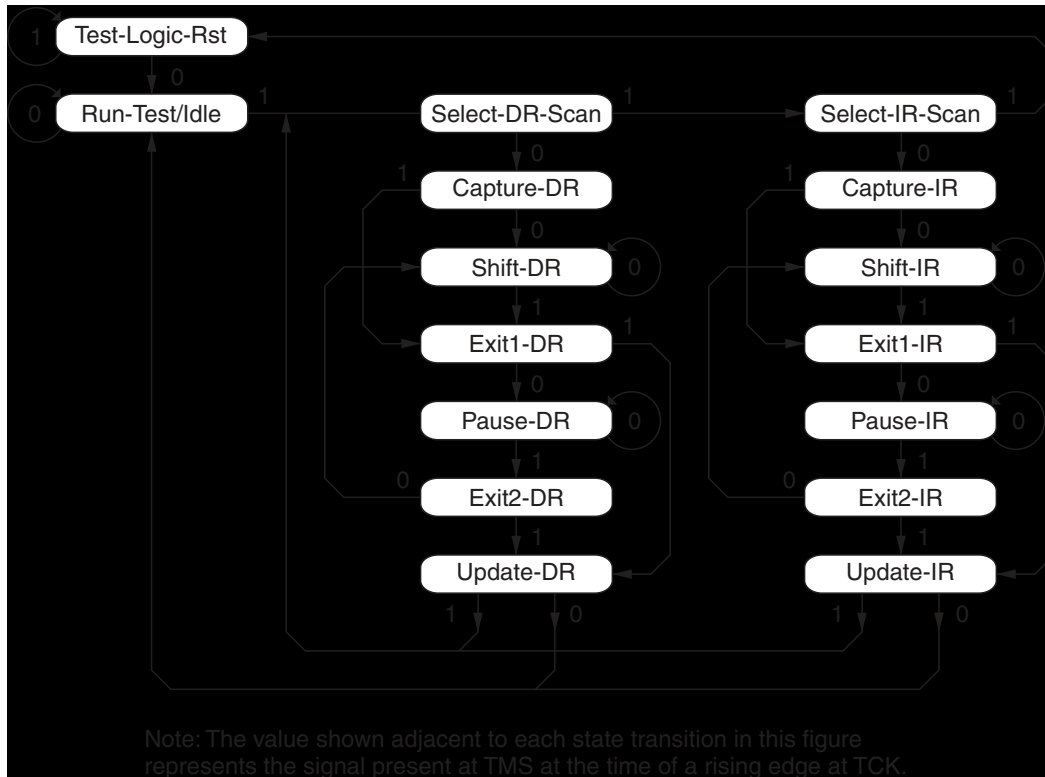

When the correct logic sequence is applied to the TMS and TCK inputs, the TAP will exit the Test-Logic-Reset state and move to the desired state. The next state after Test-Logic-Reset is Run-Test/Idle. Until a data or instruction shift is performed, no action will occur in Run-Test/Idle (steady state = idle). After Run-Test/Idle, either a data or instruction shift is performed. The states of the Data and Instruction Register blocks are identical to each other differing only in their entry points. When either block is entered, the first action is a capture operation. For the Data Registers, the Capture-DR state is very simple: it captures (parallel loads) data onto the selected serial data path (previously chosen with the appropriate instruction). For the Instruction Register, the Capture-IR state will always load the IDCODE instruction. It will always enable the ID Register for readout if no other instruction is loaded prior to a Shift-DR operation. This, in conjunction with mandated bit codes, allows a “blind” interrogation of any device in a compliant IEEE 1149.1 serial chain. From the Capture state, the TAP transitions to either the Shift or Exit1 state. Normally the Shift state follows the Capture state so that test data or status information can be shifted out or new data shifted in. Following the Shift state, the TAP either returns to the Run-Test/Idle state via the Exit1 and Update states or enters the Pause state via Exit1. The Pause state is used to temporarily suspend the shifting of data through either the Data or Instruction Register while an external operation is performed. From the Pause state, shifting can resume by reentering the Shift state via the Exit2 state or be terminated by entering the Run-Test/Idle state via the Exit2 and Update states. If the proper instruction is shifted in during a Shift-IR operation, the next entry into Run-Test/Idle initiates the test mode (steady state = test). This is when the device is actually programmed, erased or verified. All other instructions are executed in the Update state.

Test Instructions

Like data registers, the IEEE 1149.1 standard also mandates the inclusion of certain instructions. It outlines the function of three required and six optional instructions. Any additional instructions are left exclusively for the manufacturer to determine. The instruction word length is not mandated other than to be a minimum of two bits, with only the BYPASS and EXTEST instruction code patterns being specifically called out (all ones and all zeroes respectively). The ispClock5600A contains the required minimum instruction set as well as one from the optional instruction set. In addition, there are several proprietary instructions that allow the device to be configured and verified.

For ispClock5600A, the instruction word length is eight bits. All ispClock5600A instructions available to users are shown in Table 1-6.

The following table lists the instructions supported by the ispClock5600A JTAG Test Access Port (TAP) controller:

Table 1-6. ispClock5600A TAP Instruction Table

Instruction	Code	Description
EXTEST	0000 0000	External Test.
ADDRESS_SHIFT	0000 0001	Address register (10 bits)
DATA_SHIFT	0000 0010	Address column data register (89 bits)
BULK_ERASE	0000 0011	Bulk Erase
PROGRAM	0000 0111	Program column data register to E ²
PROGRAM_SECURITY	0000 1001	Program Electronic Security Fuse
VERIFY	0000 1010	Verify column
DISCHARGE	0001 0100	Fast VPP Discharge
PROGRAM_ENABLE	0001 0101	Enable Program Mode
IDCODE	0001 0110	Address Manufacturer ID code register (32 bits)
USERCODE	0001 0111	Read UES data from E ² and addresses UES register (32 bits)
PROGRAM_USERCODE	0001 1010	Program UES register into E ²
PROGRAM_DISABLE	0001 1110	Disable Program Mode
HIGHZ	0001 1000	Force all outputs to High-Z state
SAMPLE/PRELOAD	0001 1100	Capture current state of pins to boundary scan register
CLAMP	0010 0000	Drive I/Os with boundary scan register
INTEST	0010 1100	Performs in-circuit functional testing of device.
ERASE_DONE	0010 0100	Erases the 'Done' bit only
PROG_INCR	0010 0111	Program column data register to E ² and auto-increment address register
VERIFY_INCR	0010 1010	Load column data register from E ² and auto-increment address register
PROGRAM_DONE	0010 1111	Programs the 'Done' Bit
NOOP	0011 0000	Functions Similarly to CLAMP instruction
BYPASS	1xxx xxxx	Bypass - Connect TDO to TDI

BYPASS is one of the three required instructions. It selects the Bypass Register to be connected between TDI and TDO and allows serial data to be transferred through the device without affecting the operation of the ispClock5600A. The IEEE 1149.1 standard defines the bit code of this instruction to be all ones (111111).

The required **SAMPLE/PRELOAD** instruction dictates the Boundary-Scan Register be connected between TDI and TDO. The bit code for this instruction is defined by Lattice as shown in Table 1-6.

The **EXTEST** (external test) instruction is required and will place the device into an external boundary test mode while also enabling the boundary scan register to be connected between TDI and TDO. The bit code of this instruction is defined by the 1149.1 standard to be all zeros (000000).

The optional **IDCODE** (identification code) instruction is incorporated in the ispClock5600A and leaves it in its functional mode when executed. It selects the Device Identification Register to be connected between TDI and TDO. The Identification Register is a 32-bit shift register containing information regarding the IC manufacturer, device type and version code (Figure 1-33). Access to the Identification Register is immediately available, via a TAP data scan operation, after power-up of the device, or by issuing a Test-Logic-Reset instruction. The bit code for this instruction is defined by Lattice as shown in Table 1-6.

Figure 1-33. ispClock5600A Family ID Codes

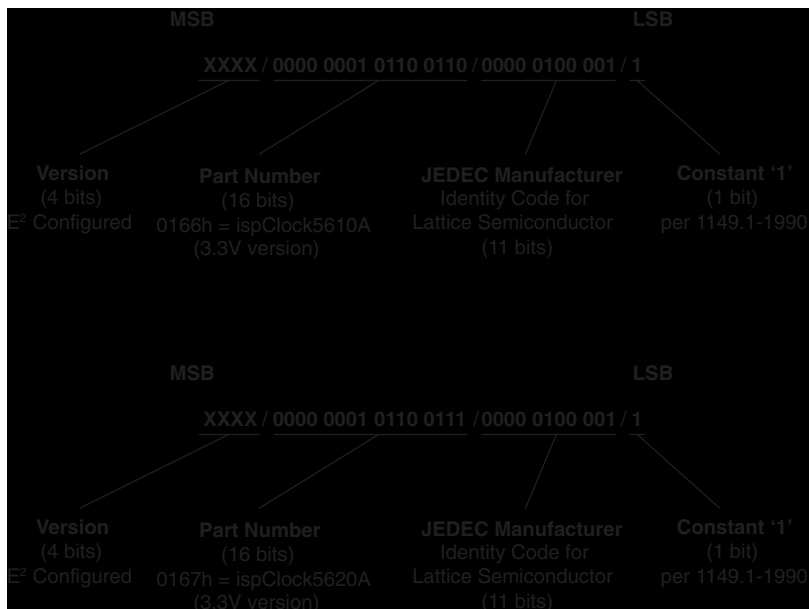

In addition to the four instructions described above, there are 20 unique instructions specified by Lattice for the ispClock5600A. These instructions are primarily used to interface to the various user registers and the E²CMOS non-volatile memory. Additional instructions are used to control or monitor other features of the device, including boundary scan operations. A brief description of each unique instruction is provided in detail below, and the bit codes are found in Table 1-6.

PROGRAM_ENABLE – This instruction enables the ispClock5600A’s programming mode.

PROGRAM_DISABLE – This instruction disables the ispClock5600A’s programming mode.

BULK_ERASE – This instruction will erase all E²CMOS bits in the device, including the UES data and electronic security fuse (ESF). A bulk erase instruction must be issued before reprogramming a device. The device must already be in programming mode for this instruction to execute.

ADDRESS_SHIFT – This instruction shifts address data into the address register (10 bits) in preparation for either a PROGRAM or VERIFY instruction.

DATA_SHIFT – This instruction shifts data into or out of the data register (90 bits), and is used with both the PROGRAM and VERIFY instructions.

PROGRAM – This instruction programs the contents of the data register to the E²CMOS memory column pointed to by the address register. The device must already be in programming mode for this instruction to execute.

PROG_INCR – This instruction first programs the contents of the data register into E²CMOS memory column pointed to by the address register and then auto-increments the value of the address register. The device must already be in programming mode for this instruction to execute.

PROGRAM_SECURITY – This instruction programs the electronic security fuse (ESF). This prevents data other than the ID code and UES strings from being read from the device. The electronic security fuse may only be reset by issuing a BULK_ERASE command. The device must already be in programming mode for this instruction to execute.

VERIFY – This instruction loads data from the E²CMOS array into the column register. The data may then be shifted out. The device must already be in programming mode for this instruction to execute.

VERIFY_INCR – This instruction copies the E²CMOS column pointed to by the address register into the data column register and then auto-increments the value of the address register. The device must already be in programming mode for this instruction to execute.

DISCHARGE – This instruction is used to discharge the internal programming supply voltage after an erase or programming cycle and prepares ispClock5600A for a read cycle.

PROGRAM_USERCODE – This instruction writes the contents of the UES register (32 bits) into E²CMOS memory. The device must already be in programming mode for this instruction to execute.

USERCODE – This instruction both reads the UES string (32 bits) from E²CMOS memory into the UES register and addresses the UES register so that this data may be shifted in and out.

HIGHZ – This instruction forces all outputs into a High-Z state.

CLAMP – This instruction drives I/O pins with the contents of the boundary scan register.

INTEST – This instruction performs in-circuit functional testing of the device.

ERASE_DONE – This instruction erases the 'DONE' bit only. This instruction is used to disable normal operation of the device while in programming mode until a valid configuration pattern has been programmed.

PROGRAM_DONE – This instruction programs the 'DONE' bit only. This instruction is used to enable normal device operation after programming is complete.

NOOP – This instruction behaves similarly to the CLAMP instruction.

Pin Descriptions

Pin Name	Description	Pin Type	Pin Number	
			ispClock5610A 48 TQFP	ispClock5620A 100 TQFP
VCCO_0	Output Driver '0' VCC	Power	1	3
VCCO_1	Output Driver '1' VCC	Power	5	7
VCCO_2	Output Driver '2' VCC	Power	9	11
VCCO_3	Output Driver '3' VCC	Power	25	15
VCCO_4	Output Driver '4' VCC	Power	29	19
VCCO_5	Output Driver '5' VCC	Power	—	51
VCCO_6	Output Driver '6' VCC	Power	—	55
VCCO_7	Output Driver '7' VCC	Power	—	59
VCCO_8	Output Driver '8' VCC	Power	—	63
VCCO_9	Output Driver '9' VCC	Power	—	67
GND0_0	Output Driver '0' Ground	GND	4	6
GND0_1	Output Driver '1' Ground	GND	8	10
GND0_2	Output Driver '2' Ground	GND	12	14
GND0_3	Output Driver '3' Ground	GND	28	18
GND0_4	Output Driver '4' Ground	GND	32	22
GND0_5	Output Driver '5' Ground	GND	—	54
GND0_6	Output Driver '6' Ground	GND	—	58
GND0_7	Output Driver '7' Ground	GND	—	62
GND0_8	Output Driver '8' Ground	GND	—	66
GND0_9	Output Driver '9' Ground	GND	—	70
BANK_0A	Clock Output driver 0, 'A' output	Output	3	5
BANK_0B	Clock Output driver 0, 'B' output	Output	2	4
BANK_1A	Clock Output driver 1, 'A' output	Output	7	9
BANK_1B	Clock Output driver 1, 'B' output	Output	6	8
BANK_2A	Clock Output driver 2, 'A' output	Output	11	13
BANK_2B	Clock Output driver 2, 'B' output	Output	10	12
BANK_3A	Clock Output driver 3, 'A' output	Output	27	17
BANK_3B	Clock Output driver 3, 'B' output	Output	26	16
BANK_4A	Clock Output driver 4, 'A' output	Output	31	21
BANK_4B	Clock Output driver 4, 'B' output	Output	30	20
BANK_5A	Clock Output driver 5, 'A' output	Output	—	53
BANK_5B	Clock Output driver 5, 'B' output	Output	—	52
BANK_6A	Clock Output driver 6, 'A' output	Output	—	57
BANK_6B	Clock Output driver 6, 'B' output	Output	—	56
BANK_7A	Clock Output driver 7, 'A' output	Output	—	61
BANK_7B	Clock Output driver 7, 'B' output	Output	—	60
BANK_8A	Clock Output driver 8, 'A' output	Output	—	65
BANK_8B	Clock Output driver 8, 'B' output	Output	—	64
BANK_9A	Clock Output driver 9, 'A' output	Output	—	69
BANK_9B	Clock Output driver 9, 'B' output	Output	—	68
VCCA	Analog VCC for PLL circuitry	Power	13	30
GND A	Analog Ground for PLL circuitry	GND	14	31

Pin Descriptions (Continued)

Pin Name	Description	Pin Type	Pin Number	
			ispClock5610A 48 TQFP	ispClock5620A 100 TQFP
VCCD	Digital Core VCC	Power	24, 33	47, 71
GNDD	Digital GND	GND	23, 48	46, 93
VCCJ	JTAG interface VCC	Power	36	74
REFA+	Clock Reference A positive input ³	Input	18	38
REFA-	Clock Reference A negative input ³	Input	19	39
REFB+	Clock Reference B positive input ³	Input	—	42
REFB-	Clock Reference B negative input ³	Input	—	41
REFSEL	Clock Reference Select input (LVCMOS)	Input ¹	—	43
REFVTT	Termination voltage for reference inputs	Power	20	40
FBKA+	Clock feedback A positive input ³	Input	15	32
FBKA-	Clock feedback A negative input ³	Input	16	33
FBKB+	Clock feedback B positive input ³	Input	—	36
FBKB-	Clock feedback B negative input ³	Input	—	35
FBKSEL	Clock feedback select input (LVCMOS)	Input ¹	—	37
FBKVTT	Termination voltage for feedback inputs	Power	17	34
TDO	JTAG TDO Output line	Output	35	73
TDI	JTAG TDI Input line	Input ²	39	84
TCK	JTAG Clock Input	Input	38	83
TMS	JTAG Mode Select	Input ²	37	82
LOCK	PLL Lock indicator, LOW indicates PLL lock	Output	34	72
SGATE	Synchronous output gate	Input ¹	40	85
GOE	Global Output Enable	Input ¹	42	87
OEX	Output Enable 1	Input ¹	21	44
OEY	Output Enable 2	Input ¹	22	45
PS0	Profile Select 0	Input ¹	44	89
PS1	Profile Select 1	Input ¹	43	88
PLL_BYPASS	PLL Bypass	Input ¹	47	92
RESET	Reset PLL	Input ¹	41	86
TEST1	Test Input 1 - connect to GNDD	Input	46	91
TEST2	Test Input 2 - connect to GNDD	Input	45	90
n/c	No internal connection	n/a	—	1, 2, 23, 24, 25, 26, 27, 28, 29, 48, 49, 50, 75, 76, 77, 78, 79, 94, 97, 98, 99, 100
Reserved	Factory use only - Do not connect	n/a	—	80, 81, 95, 96

1. Internal pull-down resistor.

2. Internal pull-up resistor.

3. Must be connected to GNDD if this pin is not used.

Detailed Pin Descriptions

VCCO_[0..9], **GNDO**_[0..9] – These pins provide power and ground for each of the output banks. In the case when an output bank is unused, its corresponding VCCO pin may be left unconnected or preferably should be tied to ground. ALL GNDO pins should be tied to ground regardless of whether the associated bank is used or not. When a bank is used, it should be individually bypassed with a capacitor in the range of 0.01 to 0.1 μ F as close to its VCCO and GNDO pins as is practical.

BANK_[0..9]**A**, **BANK**_[0..9]**B** – These pins provide clock output signals. The choice of output divider (V0-V4) and output driver type (CMOS, LVDS, SSTL, etc.) may be selected on a bank-by-bank basis. When the outputs are configured as pairs of single-ended outputs, output impedance and slew rate may be selected on an output-by-output basis.

VCCA, **GNDA** – These pins provide analog supply and ground for the ispClock5600A family's internal analog circuitry, and should be bypassed with a 0.1 μ F capacitor as close to the pins as is practical. To improve noise immunity, it is suggested that the supply to the VCCA pin be isolated from other circuitry with a ferrite bead.

VCCD, **GNDD** – These pins provide digital supply and ground for the ispClock5600A family's internal digital circuitry, and should be bypassed with a 0.1 μ F capacitor as close to the pins as is practical. To improve noise immunity it is suggested that the supply to the VCCD pins be isolated with ferrite beads.

VCCJ – This pin provides power and a reference voltage for use by the JTAG interface circuitry. It may be set to allow the ispClock5600A family devices to function in JTAG chains operating at voltages differing from VCCD.

REFA+, **REFA-**, **REFB+**, **REFB-** – These input pins provide the inputs for clock signals, and can accommodate either single ended or differential signal protocols by using either just the '+' pins, or both the '+' and '-' pins. Two sets of inputs are provided to accommodate the use of different signal sources and redundant clock sources.

REFSEL – This input pin is used to select which clock input pair (REFA+/- or REB+/-) is selected for use as the reference input. When REFSEL=0, REFA+/- is used, and when REFSEL=1, REFB+/- is used.

REFVTT – This pin is used to provide a termination voltage for the reference inputs when they are configured for SSTL or HSTL logic, and should be connected to a suitable voltage supply in those cases.

FBKA+, **FBKA-**, **FBKB+**, **FBKB-** – These input pins provide the inputs for feedback sense of output clock signals, and can accommodate either single ended or differential signal protocols by using either just the '+' pins, or both the '+' and '-' pins. Two sets of inputs are provided to accommodate the use of alternate feedback signal sources.

FBKSEL – This input pin is used to select which clock input pair (FBKA+/- or FBK+/-) is selected for use as the feedback input. When FBKSEL=0, FBKA+/- is used, and when FBKSEL=1, FBKB+/- is used.

FBKVTT – This pin is used to provide a termination voltage for the feedback inputs when they are configured for SSTL or HSTL logic, and should be connected to a suitable voltage supply in those cases.

TDO, **TDI**, **TCK**, **TMS** – These pins comprise the ispClock5600A device's JTAG interface. The signal levels for these pins are determined by the selection of the VCCJ voltage.

LOCK – This output pin indicates that the device's PLL is in a locked condition when it goes low.

SGATE – This input pin provides a synchronous gating function for the outputs, which may be enabled on a bank-by-bank basis. When the synchronous gating function is enabled for a given bank, that bank's outputs will output a clock signal when the SGATE pin is HIGH, and will drive a constant HIGH or LOW when the SGATE pin is LOW. Synchronous gating ensures that when the state of SGATE is changed, no partial clock pulses will appear at the outputs.

OEX, **OEY** – These pins are used to enable the outputs or put them into a high-impedance condition. Each output may be set so that it is always on, always off, enabled by $\overline{\text{OEX}}$ or enabled by $\overline{\text{OEY}}$.

$\overline{\text{GOE}}$ – Global output enable. This pin drives all outputs to a high-impedance state when it is pulled HIGH. $\overline{\text{GOE}}$ also controls the internal feedback buffer, so that bringing $\overline{\text{GOE}}$ high will cause the PLL to lose lock.

PS0, PS1 – These input pins are used to select one of four user-defined configuration profiles for the device.

PLL_BYPASS – When this pin is pulled LOW, the V-dividers are driven from the output of the device's VCO, and the device behaves as a phase-locked loop. When this pin is pulled HIGH, the V-dividers are driven directly from the output of the M-divider, and the PLL functions are effectively bypassed.

RESET – When this pin is pulled HIGH, all on-board counters are reset, and lock is lost.

TEST1, TEST2 – These pins are used for factory test functions, and should always be tied to ground.

n/c – These pins have no internal connection. We recommend that they be left unconnected.

RESERVED – These pins are reserved for factory use and should be left unconnected.

Package Diagrams

48-Pin TQFP (Dimensions in Millimeters)



100-Pin TQFP (Dimensions in Millimeters)

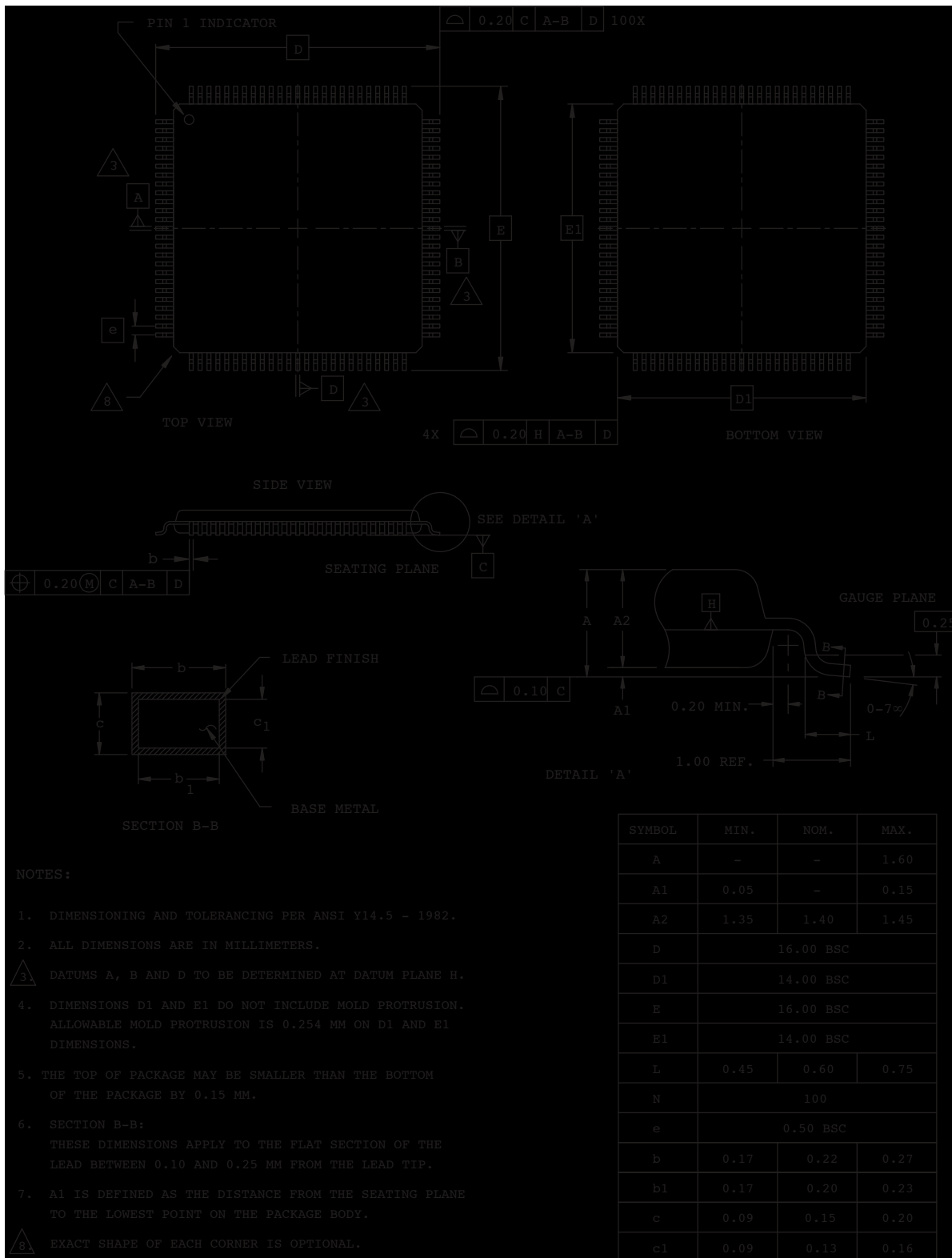

Part Number Description

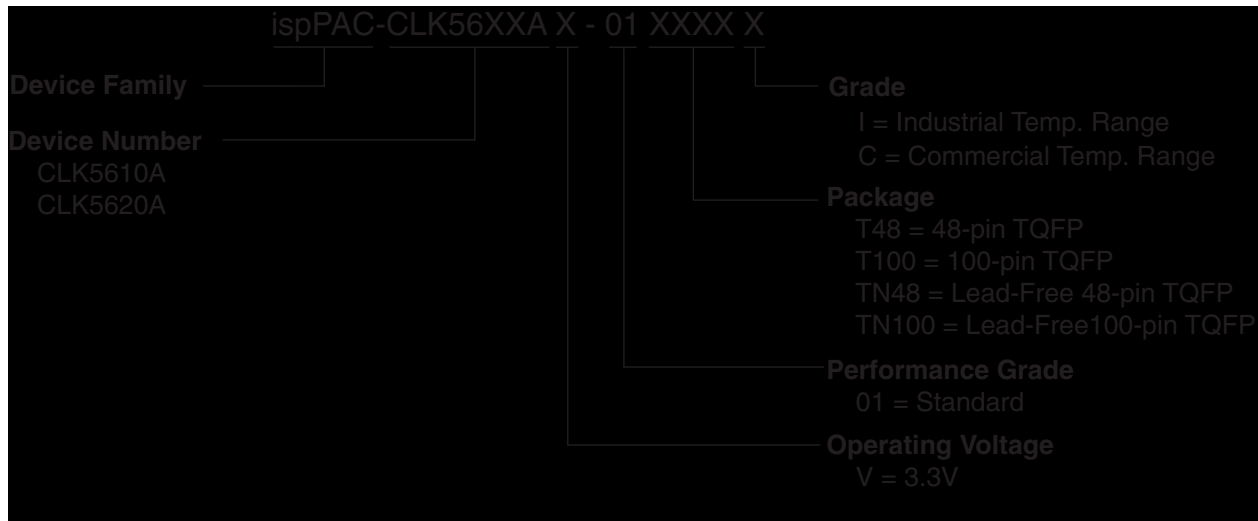

Ordering Information

Conventional Packaging

Commercial

Part Number	Clock Outputs	Supply Voltage	Package	Pins
ispPAC-CLK5610AV-01T48C	10	3.3V	TQFP	48
ispPAC-CLK5620AV-01T100C	20	3.3V	TQFP	100

Industrial

Part Number	Clock Outputs	Supply Voltage	Package	Pins
ispPAC-CLK5610AV-01T48I	10	3.3V	TQFP	48
ispPAC-CLK5620AV-01T100I	20	3.3V	TQFP	100

Lead-Free Packaging

Commercial

Part Number	Clock Outputs	Supply Voltage	Package	Pins
ispPAC-CLK5610AV-01TN48C	10	3.3V	Lead-Free TQFP	48
ispPAC-CLK5620AV-01TN100C	20	3.3V	Lead-Free TQFP	100

Industrial

Part Number	Clock Outputs	Supply Voltage	Package	Pins
ispPAC-CLK5610AV-01TN48I	10	3.3V	Lead-Free TQFP	48
ispPAC-CLK5620AV-01TN100I	20	3.3V	Lead-Free TQFP	100

Package Options

ispClock5610A: 48-pin TQFP

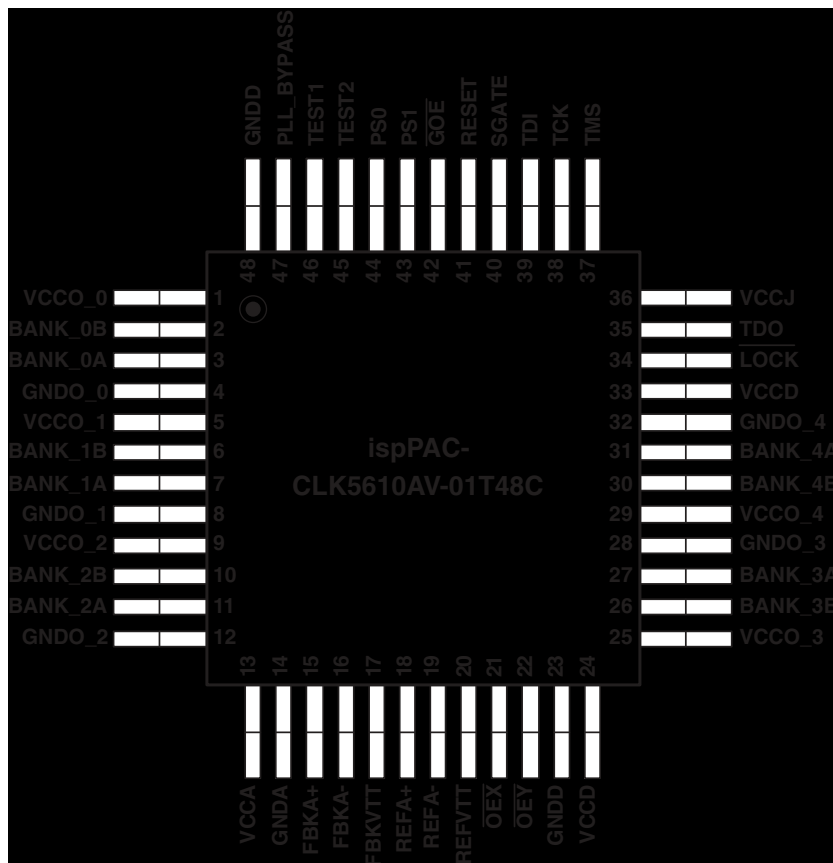

ispClock5620A: 100-pin TQFP

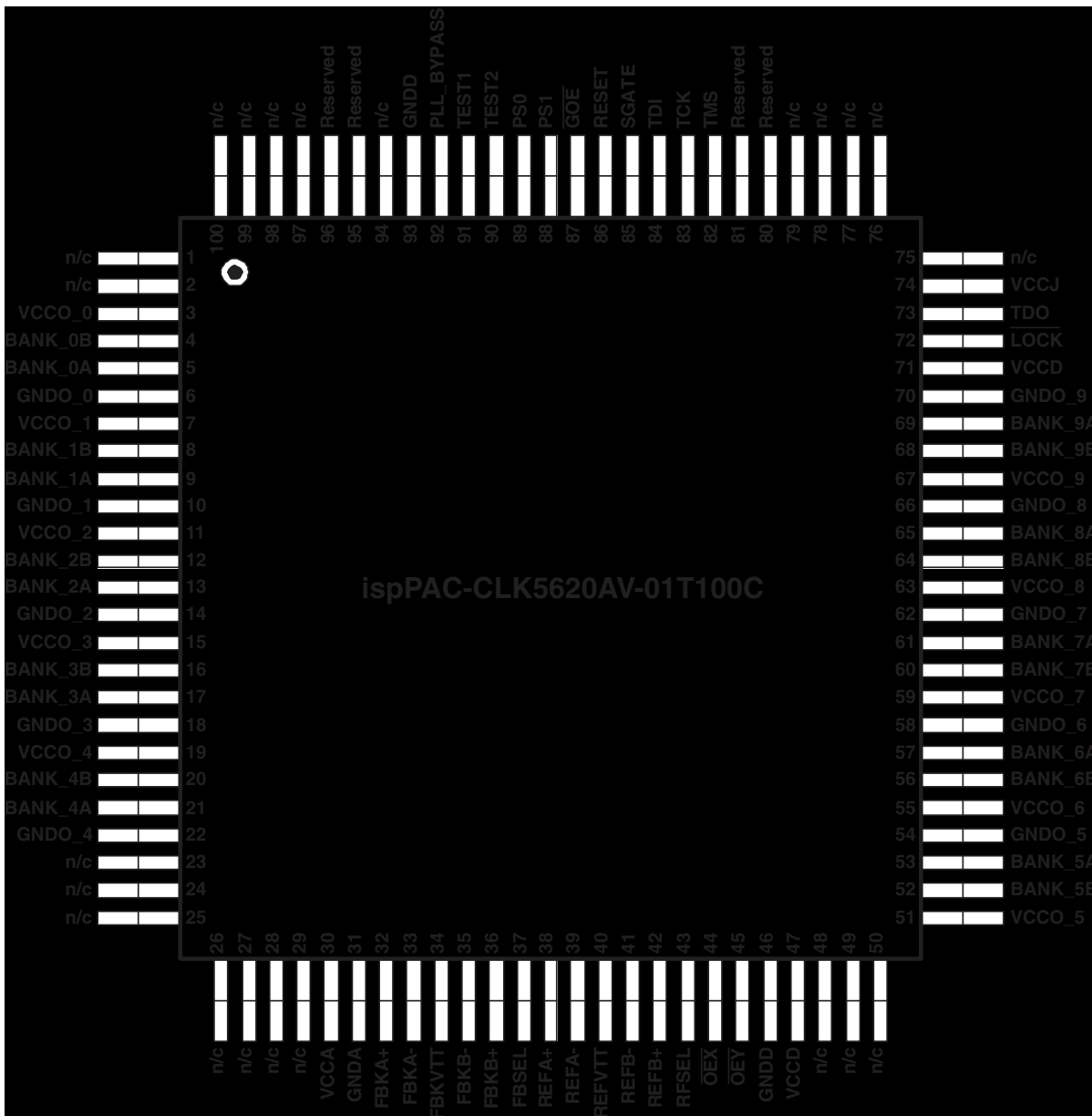

Revision History

Date	Version	Change Summary
—	—	Previous Lattice releases.
March 2007	01.3	Added min. and max. values to Timing Adders for I/O Modes table.
		Added min. and max. values to PLL Bypass Mode operation table.
		Added Phase Lock Detect feature description.
		Added M-Divider and N-Divider Bypass feature description.
		Modified logic standard related timing adder values in the Output Skew Matching Accuracy section and the Static Phase Offset and I/O Skew section.
		PFD frequency limitation for the Static Phase Offset specification is removed.
		Minimum operating voltage for V_{CCJ} is set to 2.25V.
		Updated the I_{CCD} vs. F_{VCO} graph to include 800 MHz VCO frequency operation.
June 2008	01.4	Restructured / reordered sections under "Detailed Description" and "Thermal Management"
		Added a paragraph describing RESET in the "M-Divider and N-Divider Bypass Mode" section.
		Clairified the need for resetting ispClock in the "RESET and Power-up Functions" section.